

INTELLABEAM

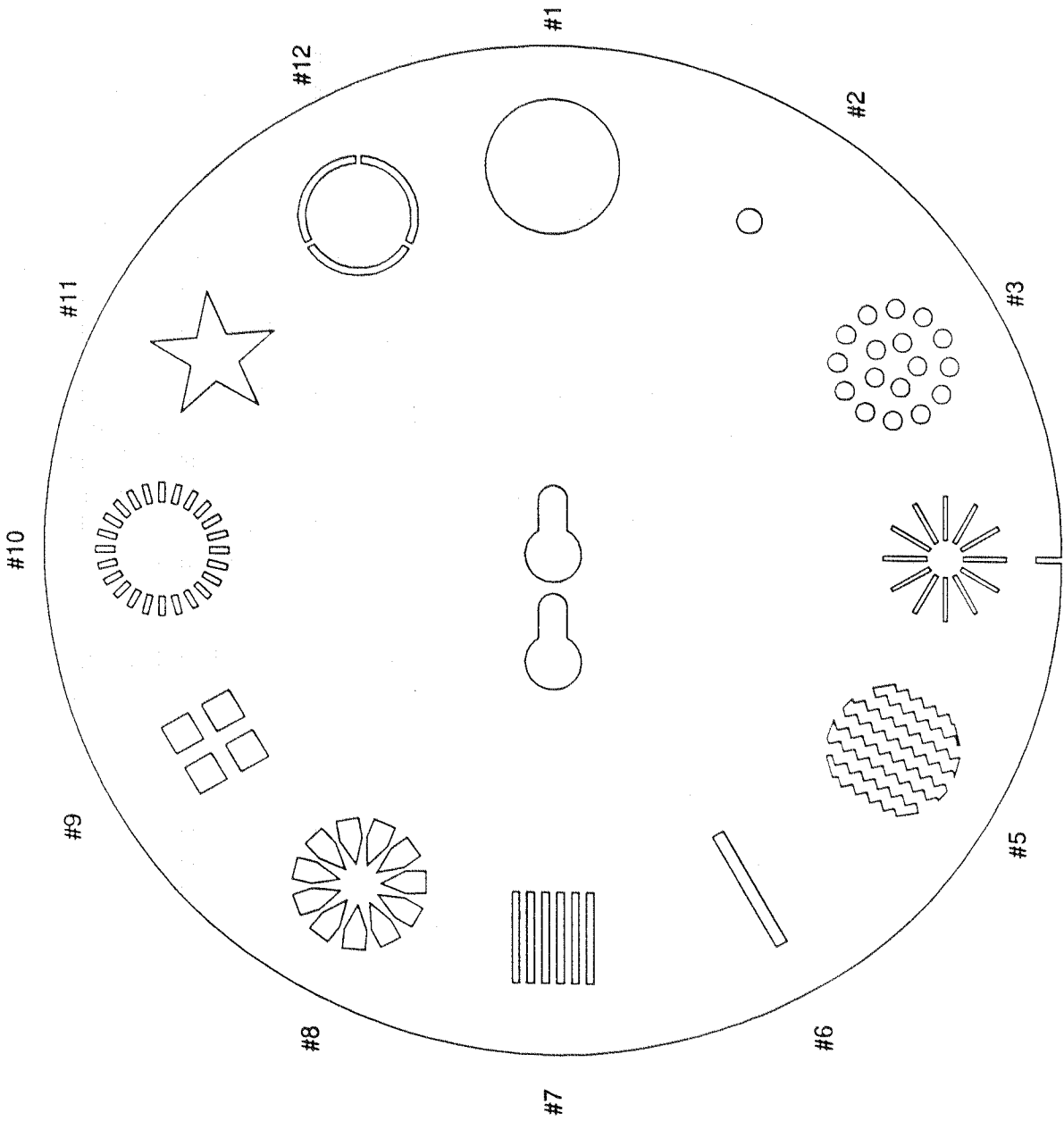

#4
Figure 10. Gobo Wheel

INTELLABEAM

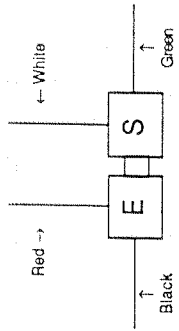

E = Emitter
S = Sensor

NOTE: It is important that the optical sensor be placed in the correct direction.

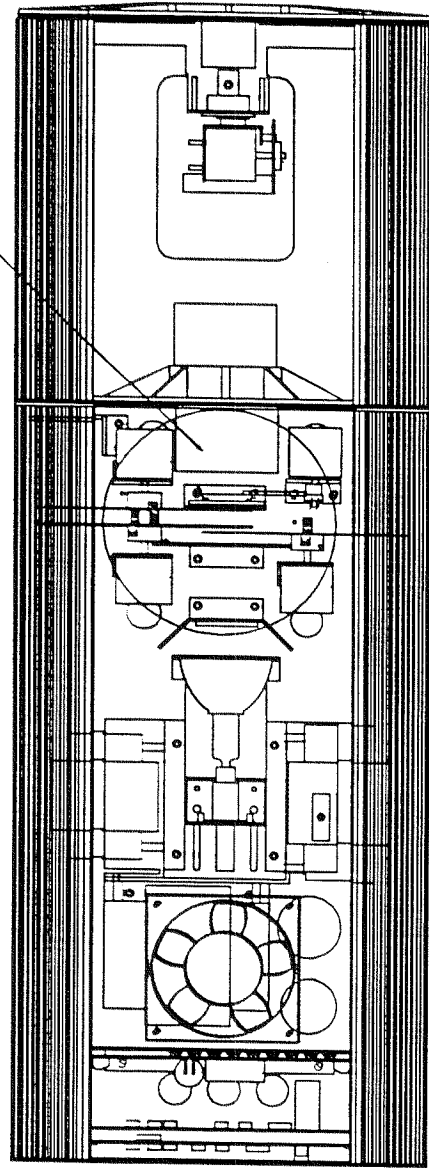
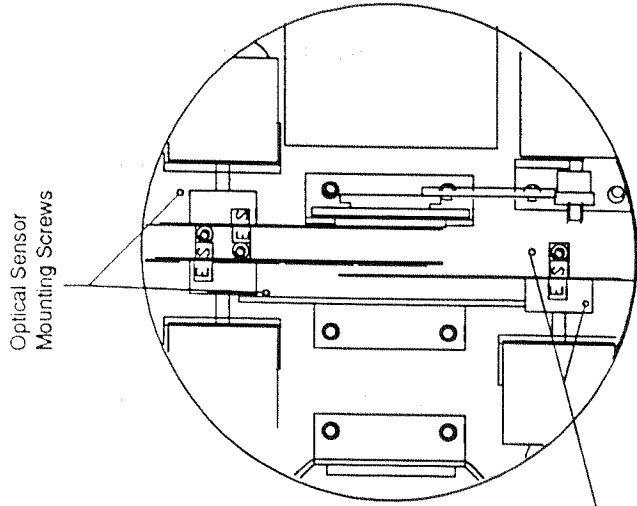

Figure 11. Optical Sensor Detail

INTELLABEAM CONTROLLER

DESCRIPTION

1. **POWER KEYSWITCH** -turns controller on and enables fixtures. The key offers protection from unauthorized use. If all lamps do not ignite upon initial power up, depress the Home key followed by the Address(es) that did not ignite.
2. **MASTER / SLAVE LED INDICATOR** -displays the controller operational mode set by the rear chassis Personality dip switch.
3. **STANDBY KEY** -closes the light gate of all connected fixtures, acting as a Master Blackout. To display current EPROM version, depress and hold the Standby key while turning on the controller.
4. **ADDRESS/PRESET LED INDICATOR** -toggles the controller between the address mode and the preset mode and the preset mode. The active mode is signified by the LED indicator. The default mode upon turn-on is the Address mode.
5. **ADDRESS/PRESET KEY PAD** -consists of 24 keys with LED indicators, corresponding to 24 Addresses or Presets. In the Address mode, these keys display active Addresses and, when depressed, the parameters associated with that Address. Specific parameters can be viewed by pressing and holding the Address key while pressing the parameter key (e.g., the Iris key). They also provide individual access to fixtures for manual control or programming purposes. In the Preset mode, the 24 keys instantly access user-stored Page and Memory information (cues and chases).
6. **I.M.P. DISPLAY (PLAYBACK MODE)** -is the basic display most often seen. It consists of Intensity, Memory, and Page information. The I.M.P. mode is indicated by decimal points at the top of the seven-segment displays.

Intensity	-shows the master brightness setting of all fixtures.
Memory	-shows current Memory number (1-9).
Page	-shows the current Page number (1-99) of the current Memory. A Page contains the settings of the programmed Addresses.

- 7. C.T.P. DISPLAY (PROGRAM MODE)** -is the Programming display consisting of Construct, Timing, and Page information. The C.T.P. mode is indicated by decimal points at the bottom of the seven-segment displays. To access this mode, depress the Select key, followed by an Address key.
- Construct -displays the current parameters of an Address (Color, Gobo, etc.) for a Page.
 - Timing -shows the current Xfade and Delay times for the current Page.
 - Page -displays current Page number.
- 8. UP \ DOWN KEYS** -are used to change parameter values and to manually change Memory and Page numbers. Keys repeat and accelerate when depressed and held. Some settings "wrap around" in both directions.
- 9. COLOR KEY** -is used to select one of twelve colors, 8 forward color spin speeds (F1-F8) or 8 alternate (reverse) color spin speeds (A1-A8).
- 10. GOBO KEY** -is used to select one of twelve patterns, 8 forward pattern spin speeds (F1-F8) or 8 alternate pattern spin speeds (A1-A8).
- 11. DIM KEY** -is used to set individual fixture Intensity from 40-99 percent.
- 12. SPEED KEY** -is used to select one of 99 mirror movement time settings. This function controls the time required for beams to move from one position to another. From these settings, the system calculates individual mirror speeds. By having direct control over beam travel time, the user is easily capable of simultaneously completing various beam movements of several (or all) fixtures.
- 13. IRIS KEY** -enables the selection of 99 beam diameters.
- 14. GATE KEY** -enables the selection of the light Gate position open (OP), closed (CL), or rotating. Eight speeds (F1-F8) are available to strobe the light output. Gate defaults to CL if a Page has never been Recorded. When Program Mode (C.T.P display) is entered, Gate is the default parameter in the display.

The Intellabeam Controller - Description

- 15. XFADE KEY** -enables the setting of Crossfade times (0.1 to 99 seconds) of lamp Intensities and Iris sizes from the previous Page into the Page being programmed. Crossfade times must be shorter than the Advance rate in order to insure their completion.
- 16. DELAY KEY** -enables the setting of a delay (from 0.0 to 99 seconds) before the current Page advances to the next. Delay time is added to the setting of the Rate. If the Rate is set at 10 seconds and the Delay at 5 seconds, 15 seconds will pass before the current Page changes during Auto Advance. C.T.P. mode defaults to Delay at a time of 0.0. When in Audio Advance mode, Delay times are overlooked.
- NOTE: XFADE AND DELAY ARE PAGE WIDE TIMING PARAMETERS.**
- 17. HOME KEY** -returns a fixture or fixtures to their Home positions at any time while in Playback Mode (I.M.P. display). It can also be used to reignite a fixture which may have failed to strike upon initial power up. To Home a group of fixtures, depress the Home key followed by the Address keys corresponding to the fixtures to be Homed. The Home and Address LED indicators will flash for 10 seconds as the procedure begins, the light Gates will close, and then the LED indicators will go out. Once Homed, the fixtures will return to their programmed positions and the light gates will open. If pages are Advancing, then the fixtures will join the sequence running. Each time the controller is powered up, all fixtures are automatically Homed before they assume the current Page settings.
- 18. SELECT KEY** -used to toggle between Playback Mode (I.M.P. display) and Program Mode (C.T.P. display). The Select Key flashes when in the Program Mode. Once the Select Key is depressed, the displays will go dark until an Address key is depressed for editing.
- 19. RECORD KEY** -stores the new settings for a chosen Address or Preset. A controller's Memory can also be downloaded to a personal computer or another controller with this key.
- 20. ERASE KEY** -is used for editing by resetting Pages or Presets to their defaults and creating Non- Initialized Pages for program loops. Memory from a personal computer or another controller can also be uploaded using this key.

The Intellabeam Controller - Description

21. **JOYSTICK** -allows for manual control of the mirror and beam. The distance that the joystick is moved from center is proportional to the speed that the mirror is moved.
22. **ADVANCE SECTION** -selects the method of sequencing a Memory's Pages.
23. **RANDOM ADVANCE** -modifies all other Advance methods, Randomly sequencing Initialized Pages.
24. **AUDIO 1 ADVANCE** -will advance Pages according to the audio input signal while ignoring all programmed Delays and Crossfades which might interfere with timing (regulated with Audio knob).
25. **AUDIO 2 ADVANCE** -pauses Page Advancement according to the audio input signal. The sensitivity level of the pause is regulated with the Audio knob and the Rate knob functions as it does during Auto Advance, i.e. it controls how fast the Pages advance between audio impulses.
26. **AUTO ADVANCE** -advances Pages at a speed set by the Rate knob. In this mode, the Rate knob adds time to the Delay setting (see also Audio 2 Advance).
27. **RATE KNOB** -controls the speed of Page Advance when in the Auto Advance mode. With the knob turned completely clockwise, Pages will advance at the fastest rate (0.1 seconds). As you turn the knob counter-clockwise, the rate of advancement decreases (all Delays affect the rate of Page advancement).
28. **AUDIO KNOB** -adjusts the controller's sensitivity to the audio input signal it is receiving for Audio Advance and Modulation. The Level LED indicates the presence and relative strength of this signal.
29. **MODULATE** -overrides and modifies programmed Color, Gobo, and Intensity settings. Any one parameter (Color, Gobo, or Intensity) or a combination of parameters may be modulated. The Audio knob regulates the sensitivity.
30. **COLOR MODULATE** -instructs all active fixtures to begin changing Colors with the music. The Color wheel begins changing from its current position, each change initiated by the audio input signal. The Audio knob regulates the sensitivity.

The Intellabeam Controller - Description

- 31. GOBO MODULATE** -instructs all active fixtures to begin changing Gobos with the music. The Gobo wheel begins changing from its current position, each change initiated by the audio input signal. The Audio regulates the sensitivity.
- 32. LIGHT MODULATE** -instructs all active fixtures to dim to their minimum Intensities, and then vary with the amplitude of the music. The Audio knob regulates the sensitivity. The maximum brightness obtainable is controlled by the master Intensity.
- 33. 8-POSITION PERSONALITY DIP SWITCH** -sets the personality of the controller to Master or Slave, 50-60 Hz for time base change, Analog Control access to Pages or Presets and other special functions.
- 34. OUTPUT LINK** -XLR female jack provides control signals to all connected fixtures. Pin 1 is shield, Pin 2 is (-), and Pin 3 is (+).
- 35. MASTER/SLAVE INPUT PORT** -1/4" stereo jack to link a master controller to a slave controller. The 38.4K BAUD output is serial data and it requires a shielded, two-conductor cable.
- 36. MASTER/SLAVE OUTPUT PORT** -1/4" stereo jack to link a slave controller to master controller. The 38.4K BAUD output is serial data and it requires a shielded, two-conductor cable.
- 37. REMOTE ENABLE** -3.5mm (1/8") mini-jack for remote Standby of controller.
- 38. STEREO AUDIO INPUTS** -two RCA type phono connectors for line-level audio signals.
- 39. ANALOG INPUT DIN CONNECTORS** -two locking 8-pin DIN connectors for the remote recall of a Memory's Pages or Presets with an analog controller.
- 40. RS-232 PORT** -for communication with computers during external memory backup and retrieval, operating at 9600 BAUD.
- 41. 240/120V SELECT** -switches input voltage.

INTELLABEAM

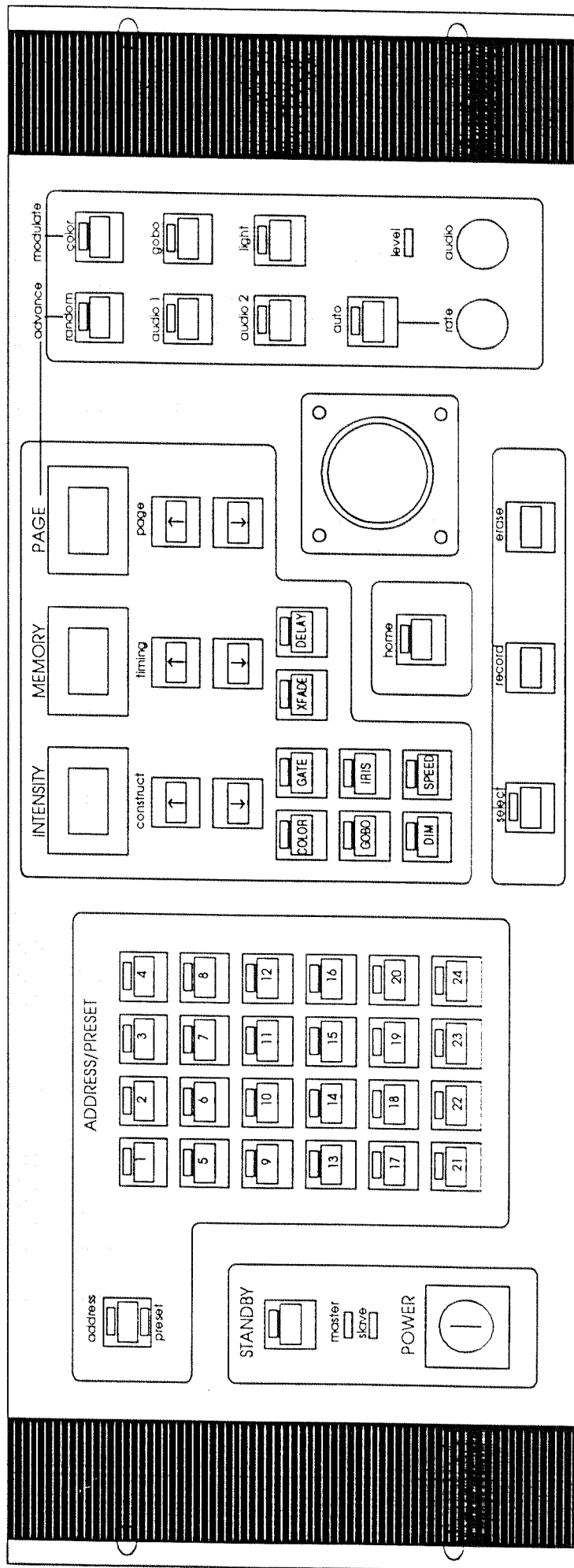

Figure 12. Controller Front Panel

SETUP

VOLTAGE SELECTION

The standard controller operates at 120 or 240 Volts. There is a Voltage Select switch on the rear chassis near the line cord that allows easy external access for choosing the appropriate Voltage (see Figure 13. Controller Rear Panel). Controllers configured for 100 Volts can be special ordered at no extra charge or a small step up transformer can be used with the standard controller. The 8-Position Personality DIP switch on the rear chassis of the controller allows for selection of 50 or 60 Hertz operation. Switch #2 should be OFF for 60 Hertz and ON for 50 Hertz.

CONFIGURATION

Located on the rear of the controller is an 8-position DIP switch labeled Personality. This switch is used for testing, set up, and control of specialized parameters.

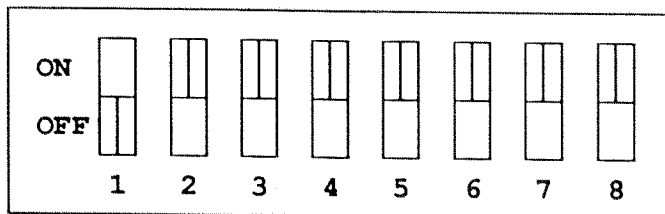

TYPICAL 8 POSITION DIP SWITCH

Switch number one pertains to the Master/Slave capability. The system is expandable beyond the normal twenty-four Addresses by linking multiple controllers via the Master/Slave port (see MASTER/SLAVE CONFIGURATION, page 46). Switch number two allows the controller to operate at either 50 or 60 Hertz. Switch number three sets up the controller to respond to the Remote Analog Access port by changing either the Page numbers or the Preset numbers (see REMOTE ANALOG ACCESS, page 43).

SWITCH	CONDITION	
1	(OFF) Master	(ON) Slave
2	(OFF) 60 Hertz	(ON) 50 Hertz
3	(OFF) Pages (Analog Access)	(ON) Presets
4	(OFF)	(ON)

Chart 3. Controller Personality DIP Switch Settings

INTELLABEAM

LIGHTWAVE RESEARCH
 AUSTIN, TEXAS USA
 Installation and operating
 procedure available in
 user manual.

WARNING
 To reduce the risk of fire or
 electric shock, do not expose
 this device to rain or moisture.

CAUTION
 To prevent electric shock, do not
 remove cover. No user-serviceable
 parts inside. Refer servicing to
 qualified service personnel.

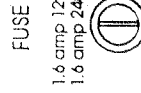
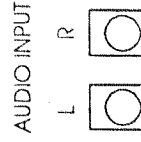
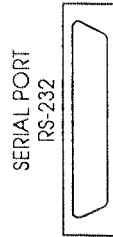
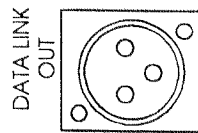

Figure 13. Controller Rear Panel

The Intellabeam Controller - Operation

OPERATION

The controller is supplied from the factory with several programs installed to demonstrate the system and to facilitate in understanding its capabilities. In these programs, all Addresses are active in order to be compatible with four to twenty-four channel systems.

When the Intensity, Memory, or Page key is depressed and held, its value will continue to change until it is released. Also, the Memory and Page values will "roll over" from its highest value to its lowest value, and vice versa (e.g., from ninety-nine to zero, or from zero to ninety-nine). To prevent accidental changes to the program, the Record key is automatically disabled while pages are advancing.

The controller should be mounted away from any sources of heat or moisture. Connect a suitable line-level stereo audio feed to the two RCA jacks in the rear panel of the controller if desired. The data cables should be connected between the controller and the fixtures as described in the DATA CABLES section on page 12.

INITIAL POWER-UP

Turn the keyswitch clockwise and the Master, Standby, and Address LED indicators will light up.

NOTE: DURING POWER-UP, BE CAREFUL NOT TO TOUCH OR MOVE THE JOYSTICK BECAUSE THE CONTROLLER INITIALIZES THE VALUE OF THE COORDINATES.

The three displays in the center of the controller will display "99 01 01" (with the decimal points on the top of the display) representing full Intensity, Memory 1, and Page 1. The lamps will ignite, the cooling fans will turn on, the fixtures will all begin to Home their mirrors and all parameters will be set to their defaults. It is normal for the fixtures to "chatter" during homing when first switched on. When configured for MSR400, the controller Light Gate defaults to the closed position. Anytime Standby is enabled in the MSR mode, the Gates will close.

IMPORTANT: IF ALL LAMPS DO NOT IGNITE UPON TURN ON - DO NOT TURN OFF CONTROLLER. TO DO SO WILL START THE INTERNAL COUNTER PREVENTING IGNITION OF ALL LAMPS UNTIL THE COOL DOWN TIME HAS ELAPSED. INSTEAD, DEPRESS THE HOME KEY FOLLOWED BY THE ADDRESS(ES) OF THE FIXTURE(S) THAT DID NOT IGNITE. THIS WILL HOME ALL SETTINGS OF THE CHOSEN ADDRESS AND RE-IGNITE THE LAMP.

CONTROL PARAMETERS

Once powered up, there are several options available. To familiarize yourself with all of the controls, experiment with the following examples. The controller has many capabilities, some of which are complex, others are more straight-forward. Let's assume that you have four fixtures set to Addresses 1-4. Notice that no light is emitted from the fixtures, although all LED indicators in the Address/Preset display are illuminated. The I.M.P. display shows "9 9 0 1 0 1" with decimal points at the top of each display. Depress the Standby key and all fixtures will be in their normal default settings. Default values are; no color, large circle gobo, closed gate, fully open iris, full intensity, fastest mirror speed, no delay, and 0.1 seconds crossfade time. Depress the Select key followed by Address numbers 1-4 (or the Addresses you have) to assume manual control. The Select and Address LED's will flash and the decimal points will move to the bottom of the display to indicate C.T.P. (Construct, Timing, Page) mode. The LED in the Gate key and the Delay key will light. Use the up key below the first window to change the Gate setting to open.

JOYSTICK

Manual control of the fixture beam positions is by joystick. This proportional control translates the distance it is moved into a speed of the mirror. Experiment with the feel and control of the Joystick before proceeding. Notice how all fixtures move together. This is the most basic way to use the fixtures. Next we will adjust some of the beam parameters.

GATE

When you selected the C.T.P. mode, the numbers in the displays also changed to C.L 0.0 0.1 and the Gate and Delay LED indicators lit. The first number is the Gate setting, the second is the Delay time in seconds, and the last one is the Page number of these settings.

Since the controller defaults the Construct section to Gate each time the C.T.P. mode is chosen, we will adjust it first. Depress one of the arrow keys below the Construct display to select Gate Open (OP), Closed (CL), or strobing at one of 8 speeds (F1-8).

COLOR, GOBO, DIM, IRIS, AND SPEED

Individual parameters are accessed by depressing the appropriate key and then using the up or down keys to change the settings. There are twelve color settings and two directions of spin. If either the up or down key is depressed and held, the display will run and stop at either extreme of Color one or twelve. If the key is released when twelve is reached and then depressed again, the forward speeds F1 through F8 will be available. The speed refers to the spin of the Color Wheel. Continue holding the 'up' key and the display will stop at F8. Release it and

The Intellabeam Controller - Operation

depress it again to reach Alternative speeds A1 through A8 (wheel will spin in the opposite direction). From A8, the controller will return to normal Color selections one through twelve when the up key is depressed again.

The Gobo Wheel is controlled in the same manner as the Color Wheel. It also has twelve templates, eight forward spin speeds and eight alternate (reverse) spin speeds.

The Dim key refers to the Intensity of the selected fixtures. It has sixty settings (forty through ninety-nine) for the MSR version.

The Iris key adjusts the size of the beam in ninety-nine increments.

The Speed key controls the speed of the mirror as it moves from one Page to another.

After you have experimented with these adjustments and moved the beams around with the joystick, you have more options. If you depress Record, all adjustments including the last mirror position will be Recorded in Memory 1, Page 1. For this example though, depress Select again to return all the fixtures to their original settings. In Standby, all parameters are still adjustable but will not be visible.

DELAY AND XFADE

These two parameters are only used during Programming. Delay is the time, from 0.0 to 99 seconds, that elapses before the current Page changes to the next. Crossfade is the time it takes to change lamp Intensities and Iris sizes of the previous Page to the current Page. If both Pages have the same Intensity and/or Iris values, no change will be visible. Delay is the default when in the C.T.P. mode with possible settings of 0.1 to 99 seconds.

PROGRAMMING

The controller contains a total of 891 Pages capable of storing the settings of twenty-four addresses of fixtures. Nine memories of ninety-nine Pages each divide the total Memory into groups. There are also twenty-four Presets (or 288 Presets with a remote analog input-see page 40, RECORDING PRESETS and page 43, REMOTE ANALOG PAGE ACCESS) capable of storing a Page of a Memory each. Together, these provide a useful combination of accessibility and programmability.

ADDRESSES

To Program Addresses, ensure that the Address LED (on the Address/Preset selection key) is lit and that all Advance modes are off. Choose the Memory and Page to begin on. Depress the Select key and the LED will begin to flash. The displays will also go dark until an Address is chosen. Then, the decimals in the displays will drop to the bottom and the chosen Address's LED will flash with Select. The Gate LED in the Construct section and the Delay LED in the Timing section will illuminate. All parameters will be at their default values unless prior programming has occurred. Depress Record to save any changes or Select again to return to the prior settings.

EDITING/RECORDING A PAGE

Editing is the same as Programming. Select the Memory and Page to Edit and depress Select. Choose the Address(es) to change with the Address keys and modify any parameters. When complete, depress Record.

ERASING A PAGE

If it becomes necessary to Erase a previously Programmed Page, it is a simple procedure. Go to the Page to be Erased after disabling all Advance modes. Depress Select, then Erase, followed by Record.

CREATING A LOOP

The creation of a loop allows a number of steps to run endlessly until directed otherwise. After Programming a number of Pages, a Non-Initialized Page must be created as a pointer to the controller to return to the first Page in the series. Advance to the Page following the last step in the Program. Depress the Select key, then the Erase, then the Erase key a second time. The I.M.P. display will show blanks in the first two windows and the Page number in the third before reverting to the normal IMP display. This Page is now Non-Initialized and anytime the preceding Pages are advanced by some mode other than the manual mode, the Non-Initialized Page will cause the controller to return to the first Page in the sequence.

COPYING FUNCTIONS

Once an Address has been Programmed, some or all parameter settings can be copied to other Addresses. This saves time when many fixtures need to have the same or similar settings or positions.

SELECTIVE PARAMETER COPYING

After you adjust the parameters for a particular Address but have not Recorded them, depress the Addresses to have the same values. Then depress Record to copy those settings.

The Intellabeam Controller - Operation

For example: You only want to copy the Gobo setting to other Addresses on that Page. Depress Select followed by the Address to be copied. Choose the Gobo (star) and before adjusting any other parameters, depress the Address(es) to copy to. Then depress Record and that Gobo selection is stored in all chosen Addresses. You could now return to the first Address and adjust other parameters.

PAGE COPYING

This feature copies the entire contents of a Programmed Page to any other Page in any other Memory. To copy a Page, call up the Page of the Memory you wish to copy and depress the Select key. The display will go dark until you choose the Memory and Page you wish to copy to with the up/down keys below the Memory and Page displays. Then "PC" (for Page Copy) will appear in the first window, the Memory number in the second and the Page in the last. Depress the Record key and all information will be copied to the chosen Page. The controller will then resume normal operation. Repeat this operation as many times as necessary.

RECORDING PRESETS

There are twelve groups of twenty-four Presets, or a total of 288 Presets available for instant access when used in conjunction with a remote analog input. Each group of twenty-four Presets corresponds to one channel of the remote analog input port. For example, the first group of Presets can be called up by activating analog input channel number one. The second group can be called up by activating channel two, and so on. If the remote analog port is not used, then the controller can only access the twenty-four Presets stored in group one. The Presets are provided to allow immediate recall of a programmed Page or sequence of Pages. They also store Advance and Modulation information, including the Advance rate. The audio level, however, is independent of the Presets. The settings in the Advance section can be changed in playback after selecting a Preset.

To record a Preset, the controller must be in Preset mode as indicated by the LED indicator on the Address/Preset key. Depressing the Address/Preset key in the upper left hand corner of the controller will toggle between the Address and the Preset mode. Advance to the Page that is to be stored as a Preset. If it is a sequence of Pages, then any Page within the sequence will suffice. Adjust all settings on the parameters to be stored including advance method and advance rate if it is a sequence. Depress the Select key and the LED indicator will begin to flash. Then depress the Preset number where the Page settings are to be stored. If the analog port is being used for Preset storage and retrieval, activate the channel number corresponding to the Preset group at this time. Depress the Record

key and the Preset will be recorded (see REMOTE ANALOG PAGE ACCESS, page 45 to playback Preset).

MEMORY LOCKOUT

Entire Memories can be protected from unauthorized Editing or Programming by using the Memory Lockout feature. To lockout a Memory, depress and hold the Standby key while turning on the Key Switch. Continue holding the Standby key and lock or unlock any Memory by depressing the corresponding key number (one through nine) in the Address/Preset display. If an LED in the Address/Preset display is lit while the Standby key is depressed, it indicates that the Memory is unlocked and can be programmed or edited. If an LED is off, the Memory is locked but not necessarily programmed. You may toggle between locked and unlocked as long as the Standby key is depressed. Once the Standby key is released, the controller will perform its normal Memory check. When locked, a Memory is protected from all Erase and Record functions. When a locked Memory is accessed and an attempt made to Record, "L.C" is displayed in the first window, indicating that any changes are temporary and not Recordable.

PLAYBACK

Once the controller is programmed, the Pages of Memory can be played back in random or in sequence to facilitate a show. Several programs are supplied with the controller to demonstrate the system. These programs consist of several short loops located in Memory 1 for manual sequencing, automatic Advancement, Audio Advancement, and/or Modulate.

PAGE ADVANCE

In the playback mode, there are a number of ways to advance the Pages of Memory; they can be advanced manually, automatically or they can be audio modulated. Any of the playback methods can be in random or in sequence.

MANUAL

To manually playback a Memory, remove the controller from Standby and depress the up or down key beneath the Page display once. Each time that key is depressed, the fixtures will change their settings immediately according to the program. Depressing and holding either key will change Pages until the controller reaches 1 or 99, then it will roll-over and continue changing.

During this playback, several Pages may produce no output from the fixtures. These could be blank or dark Pages, but in this case they are Non-initialized Pages. These mark the end of several Pages that will loop together. If you stop the Program on one of these Pages and depress an Address key, dashes appear in the displays with decimal points at the

The Intellabeam Controller - Operation

bottom. A blank Page would show some value along with the decimal points at the bottom. This looping allows the creation of a number of small programs within each Memory.

AUTO

Automatic playback runs the Programs at a speed set with the Rate knob. If the controller is not in Standby, depress the Auto key and set the speed of change. Pages 1-10 will run in a loop over and over. If you wish to stop the Program on a Page, depress the Auto key again. The Program will halt on the Page displayed. To select another loop, turn off Auto and use the up key to change to Page 12. When Auto is depressed now, it will run Pages 12 through 20.

AUDIO 1 & 2

These methods of Advancement use the audio signal received at the RCA jacks to make the Program Advance or pause with the beat of the musical information. Set the Audio level with the Audio Knob until the LED above the knob flashes. Audio playback ignores any Programmed Crossfades or Delays to maintain synchronous change with the music. Audio playback, however, will continue to recognize Non-initialized Pages and run that loop of Pages until directed to another Page above or below that group.

RANDOM

This mode of Advancement only functions with one of the other methods. It alters the playback of Pages from a normal sequential order to one completely Random. With Random engaged, playback of Memory 1 would only consist of Programmed Pages such as 1 then 32 then 12 then 90 then 54 and so on. This happens during Manual Page changes, Auto, or Audio. Non-initialized Pages are not accessed but Dark Pages will. If a Memory is only Programmed up to Page 50 and then a Non-initialized Page installed, only Pages 1-50 would be randomly accessed.

MODULATE

Modulate overrides and modifies programmed Color, Gobo, and Intensity settings. Any one selection or all selections may be used and are regulated with the Audio knob.

COLOR MODULATE

Color Modulate instructs all active fixtures to begin changing colors with the music. The color wheel begins changing from its current position, each change initiated by the audio input signal.

GOBO MODULATE

Gobo Modulate instructs all active fixtures to begin changing gobos with the music. The Gobo wheel begins changing from its current position, each change initiated by the audio input signal.

LIGHT MODULATE

Light Modulate instructs all active fixtures to dim to their minimum intensities, and then vary with the amplitude of the music. The maximum brightness obtainable is controlled by the Master Intensity. All Modulate settings are temporary and can be used to change the Program that is playing back.

REMOTE ANALOG ACCESS PORT

The two locking 8-pin DIN connectors located at the rear of the controller provide direct access of up to ninety-nine Pages of a selected Memory or any of the 288 Presets (see Chart 4 below for pinout). The Personality DIP switch setting on the rear of the controller determines whether the port will access a Preset or a Page (see Figure 13. Controller Rear Panel). The Remote Analog Access port has priority over a front panel key selection; an active input channel prevents any subsequent change of Page number on the controller front panel until the channel is de-activated. Only the Remote Enable jack can override the analog input port. To remotely access Pages and Presets, any control device able to provide twelve channels of at least 3.5 VDC (such as a theatre console, a rock desk or a touch panel) will suffice.

REMOTE ANALOG CONNECTORS 1 - 6 & 7 - 12	
CHANNEL NUMBER	PIN NUMBER
1 or 7	3
2 or 8	4
3 or 9	5
4 or 10	6
5 or 11	7
6 or 12	8
common negative	2
not used	1

Chart 4. Controller Pinout for Remote Analog Access Port

The Intellabeam Controller - Operation

The Remote Analog Access port can be used with the controller in or out of the Standby mode. If Standby is on, the analog input signal will override the Standby key and it will begin to flash. It will access the chosen Page or Preset and the Standby key will continue to flash as long as that channel is active. De-activating the channel will return the controller to the Standby mode.

If Standby is off, the analog input signal will call up the appropriate Page or Preset. When the key is released, the controller will continue to run in the same mode that it was in prior to receiving an analog input signal.

NOTE: THE STANDBY LED WILL FLASH WHENEVER THE CONTROLLER SENSES AN INPUT TO THE REMOTE ANALOG INPUT PORT.

REMOTE PAGE ACCESS

To use the Remote Page Access feature, the controller Personality DIP switch must be set with switch number three in the "off" position.

The input channels one through twelve correspond directly to Page numbers one through twelve. Activating channel one will call up Page one on the control panel, and channel two will call up Page two, and so on. If any combination of two channels are turned on, it will call up the Page number corresponding to the combination of the two channel numbers, with the lowest channel number first and the highest channel number second. For example, if channels one and two are activated simultaneously, it will call up Page twelve on the control panel. If channels three and seven are activated, it will call up Page 37.

Channels ten, eleven and twelve, besides corresponding to the matching Page numbers, are also used as special function keys. Channel ten is a ten-times multiplier, channel eleven is a number doubler, and channel twelve is a number inverter. For example, if channels five and ten are activated, it will call up Page fifty. If channels two and eleven are activated, it will call up Page twenty-two. If channels two, four, and twelve are activated, it will call up Page forty-two (instead of twenty-four). Chart 5 below, summarizes the function of the twelve Remote Analog input channels.

If more than two of the input channels one through nine are activated simultaneously, only the lowest two will be selected. The Advance, Modulate, and Memory selection features remain fully active during remote access.

Channels 1-12	Access Page or Preset group 1-12
Channels 10-12	Are also special function keys
Channel 10	Ten-times multiplier for channels 2-9. Allows access to Pages 20, 30, 40, 50, 60, 70, 80, & 90.
Channel 11	Number doubler for channels 2-9. Allows access to Pages 22, 33, 44, 55, 66, 77, 88, & 99.
Channel 12	Number inverter for channels 2-9. Inverts the order of the two lowest channels activated simultaneously, e.g. 32 will become 23.

CHART 5. REMOTE ANALOG INPUT CHANNEL FUNCTIONS

REMOTE ANALOG PRESET ACCESS

To use the Remote Preset Access feature, the controller Personality DIP switch must be set with switch number three in the "on" position, and the controller must be in the Preset mode. To enter the Preset mode, depress the Address/Preset key on the controller front panel until the Preset LED indicator lights up.

There are twelve groups of twenty-four Presets, or a total of 288 Presets available for instant access when used in conjunction with a remote analog input. Each group of twenty-four Presets can be readily accessed by activating the corresponding analog input channel. For example, the first group of Presets can be called up by activating analog input channel number one. The second group can be called up by activating channel two, and so on. To activate a group of Presets, the analog input signal can be momentary or it can be latched on. If the remote analog port is not used, then the controller can only access the twenty-four Presets stored in group one.

Once the appropriate analog input channel has been activated, a particular Preset can be accessed by depressing an Address/Preset key (numbered keys 1-24). That Preset will continue to operate until another Preset key is depressed, the Preset group number is changed, or the controller is placed in the Standby mode.

REMOTE ENABLE

Located on the rear panel of the controller is a Remote Enable input jack that allows an external source to take the controller in and out of standby. The Remote Enable input overrides all over functions. The jack is a normally closed, 3.5mm (1/8") mini-jack that accepts a 3.5mm mini-phone plug. The controller functions routinely with no input to the Remote Enable input. When a plug inserted into the jack, the controller goes into standby and remains there until voltage (positive 5-16 VDC) is sensed. The voltage restores the controller to its prior mode of operation.

MASTER/SLAVE CONFIGURATION

An Intellabeam system is expandable via the Master/Slave port to accommodate any multiple of twenty-four control channels or addresses. By using a two conductor shielded cable with 1/4" stereo plugs on each end, multiple controllers can be linked together to build a system for any number of independent fixture Addresses. To slave one controller to another, set the Personality DIP switch number one on the Master to the "off" position and set switch number one on the Slave to the "on" position. The LED indicators on the front panel will indicate the current status of the Master/Slave switch. Plug the cable from the jack labeled "Master out" on the Master controller to the jack labeled "Slave in" on the Slave controller.

To program a Master/Slave system, each controller must be programmed individually from its own front panel. Playback, however, is controlled only by the Master controller; it will dictate the mode of playback for all Slaved controllers. All of the LED indicators, including Standby, Advance, and Modulation settings will be mimicked on the front panel of each Slave controller. The only control that is retained by the Slave controller is Power, Address, Home, Select, Record, and Erase. All other function keys will indicate "S L" (for Slave) in the display when depressed.

FIXTURE EXCLUSION (ADDRESS DISABLE)

This feature enables the temporary removal of one or more fixture Addresses from all sequences. The fixture shuts off the lamp and does not respond to the controller until removed from Lock Out. This would be necessary if a unit were to malfunction or if you wanted to remove an Address from a Program for a special event or effect. Removing a fixture in this manner does not require any reprogramming since nothing was actually changed.

To disable an Address, depress and hold the desired Address key for twenty seconds. The LED above the key will begin to flash and then "L.O" appear in the first window. Thereafter, anytime that Address key is depressed, "L.O" will appear as a reminder that it is Locked-Out. To return the Locked-Out Address to normal functioning, repeat the process. When the controller is turned off and then back on, all Locked-Out Addresses are automatically reset.

MEMORY SEQUENCING

You may Sequence the Initialized Pages of all Memories together for a 891 Page show if necessary. Any Non-Initialized Pages will be overlooked as if they were not there. Pages will sequence in order according to the Advance method selected unless the Random key is enabled. With Random on, the Pages in each Memory will randomly sequence for a certain amount of time before changing to the next Memory. The Memories will always sequence in order (1-9), regardless of other settings, manual or automatic.

Activate the All Memory sequence mode by depressing and holding the up or down key until the Memory display reads "A 1". The Page display will read "0'1" and Intensity will remain the same. Choose an Advance method to sequence through the Initialized Pages of Memory one. An "A" (signifying All Memory Scan) will precede each Memory number during sequencing. Upon reaching the highest Initialized Page in Memory one, the controller will advance to Memory two. The Pages of Memory two will sequence in the same manner and then continue on to Memory three all the way up through Memory nine. Once Memory nine is completed, the process will start over at Memory one. If a Memory is not programmed and has no Initialized Pages, then that Memory will be skipped. The controller will continue to run through all Memories until sequencing is disabled. To cease all memory scan, disable all Advance methods and depress the Memory up or down key until "A" is no longer displayed, returning the controller to normal operation.

SELECTIVE SEQUENCING

Selective sequencing is possible using Presets to access Pages in preconstructed loops within individual Memories. Use the Presets to jump manually from one loop to another. The creation of a loop of Pages is easily accomplished. Create a Non-Initialized page followed by a number of programmed pages and then create another Non-Initialized Page. Repeat this process several times, keeping track of the beginning Page numbers of each loop. Now switch the controller to Preset mode. Record the beginning Page numbers of each loop constructed as individual Preset numbers. Select an Advance mode and try depressing those Presets just recorded. Each time a different one is depressed, it will call up the beginning of the created loop and then begin running the loop according to the Advance mode. The speed that each loop is run through is controlled by the chosen Advance mode and any adjustments available to it.

REALTIME CONTROL

You may take manual control of one or more fixtures while a program is running by depressing the Select key and the Address(es). This allows you to use the fixture in the follow spot mode. All parameters can be adjusted temporarily without altering a Memory's contents as long as the Record key is not depressed. When manual control is no longer desired, return them to the Program running by depressing Select again. To prevent accidental changes, the Record key is automatically disabled while pages are advancing.

EXTERNAL MEMORY STORAGE AND TRANSFER

The Intellabeam controller contains a self-recharging NiCad battery backup for memory storage. All programming information is automatically retained even during power down or power failure. It is possible, however, to backup the memory on a high-density floppy disk or hard drive to insure against the loss of data or to increase the amount of programming space available.

NOTE: Memory storage and transfer can be performed with most commercially available communications software capable of ASCII file transfer.

Inside the front cover of this manual is a disk which contains a communication program to facilitate the transfer of memory to and from a computer. It requires an IBM AT (TM) or compatible computer with a high-density disk drive and RS-232 serial port. The controller and computer should be linked together with a standard RS-232 cable using their respective RS-232 output ports (see Figure 13. Controller Rear Panel). The controller must be in the Standby mode to initiate the transfer of data.

To begin the program, boot up the computer and insert the disk into the floppy drive. From the DOS prompt, type the command "IBB" and press the ENTER key. After loading, the program will display the title "Intellabeam Backup v 1.00" followed by the menu. Select from the menu by typing the first letter of the line or moving the light bar with the arrow keys until the proper line is highlighted and pressing the Enter key. The program will then provide instructions on how to proceed. The outline below will assist in uploading and downloading data.

DOWNLOADING

The controller must be in the standby mode to initiate a memory transfer. To download the memory from the controller to the computer, choose the "S" (save) option from the backup program menu. It will then prompt you to enter a file name to which the memory will be saved. After entering the file name, depress and hold the Record key for about twenty seconds until the display reads "S A 0 1 0 1". When the computer is ready to receive the data, depress the Record key again to begin the transfer to the computer. The controller will display the Memory and Page number as it is being saved to disk. After saving all nine

Memories and ninety-nine Pages, the program will prompt you to terminate the transfer at the computer keyboard. Return the controller to normal operation by depressing the Select key. Upon completion of the memory transfer, all Memories will have been downloaded to the computer and saved on disk. The controller will still retain all of the data.

UPLOADING

The controller must be in the standby mode to initiate a memory transfer. To upload data from the disk to the controller, choose the "P" (play) option from the backup program menu. It will then prompt you to enter the file name from which the memory will be loaded. If you do not know the file name, all of the files can be listed by choosing the "L" (list) option from the main menu. After entering the file name, depress and hold the Erase key for about twenty seconds until the display reads "P L 0 1 0 1". When the Erase key is released the Select key will light up. The computer will prompt you to enter a "Y" on the keyboard and the transfer will begin. As the file is being transferred to the controller, the Memory and Page display will count up. When the transfer is complete, the display will be at Memory nine, Page ninety-nine and the controller will be loaded with the new memory. Depress the Select key once to return to normal operation.

CROSSLOADING

The controller must be in standby to initiate a memory transfer. It is possible to copy the Memories from one controller (controller "A") to another (controller "B"). To do so requires a cable with a male RS-232 connector on both ends, with only three wires connected in the following fashion; pin seven to pin seven, pin two on one connector to pin three on the other, and pin three on one to pin two on the other (see Chart 6. Pinout for Crossloading Memory). Connect the RS-232 cable between the two RS-232 ports on the back of the controllers. Put controller "A" (the controller being copied from) in the Save mode (display will read "S A 01 01") and the controller "B" in the Play mode (display will read "P L 01 01"). Depress the Record key of controller "A" to begin the transfer. When the transfer is complete, the display will be at Memory nine, Page ninety-nine and the controller will be loaded with the new memory. Depress the Select key once on each controller to return to normal operation.

CONNECTOR "A"	CONNECTOR "B"
Pin 2	Pin 3
Pin 3	Pin 2
Pin 7	Pin 7

Chart 6. Pinout for Crossloading Memory

1
2
3
4
5
6
7
8
9
10
11
12
13
14
15
16
17
18
19
20
21
22
23
24
25
26
27
28
29
30
31
32
33
34
35
36
37
38
39
40
41
42
43
44
45
46
47
48
49
50
51
52
53
54
55
56
57
58
59
60
61
62
63
64
65
66
67
68
69
70
71
72
73
74
75
76
77
78
79
80
81
82
83
84
85
86
87
88
89
90
91
92
93
94
95
96
97
98
99
100

SPECIFICATIONS

FIXTURE SPECIFICATIONS

Voltage/Current: 100V/7A, 120V/6A, 240V/3A
50 or 60 Cycle Selectable

DIMENSIONS: 911mm L x 204mm H x 325mm W
BOXED: 1118mm L x 432mm H x 533mm W

WEIGHT: 26.4 Kgs
BOXED: 31.9 Kgs

CONTROLLER SPECIFICATIONS

Remote Analog Control inputs - two 8-pin DIN sockets
Input voltage enable threshold - 3.5 VDC
Input voltage disable threshold - 1.5 VDC

Remote enable/standby via 3.5mm (1/8") normally closed jack.
Input voltage of +5 to +16 VDC closes circuit.

Remote fixture power enable and Auto remote cooling system shutdown.

Voltage selectable - 120/240V, 50/60Hz
Current - Fused at 1.5 A. (20mm X 5mm)

Standard Rack Mount - 4 spaces

DIMENSIONS: 475mm W X 175mm H X 344mm D
BOXED: 538mm W X 244mm H X 457mm D

WEIGHT: 7.2 Kg
BOXED: 9.1 Kg

specifications subject to change without notice

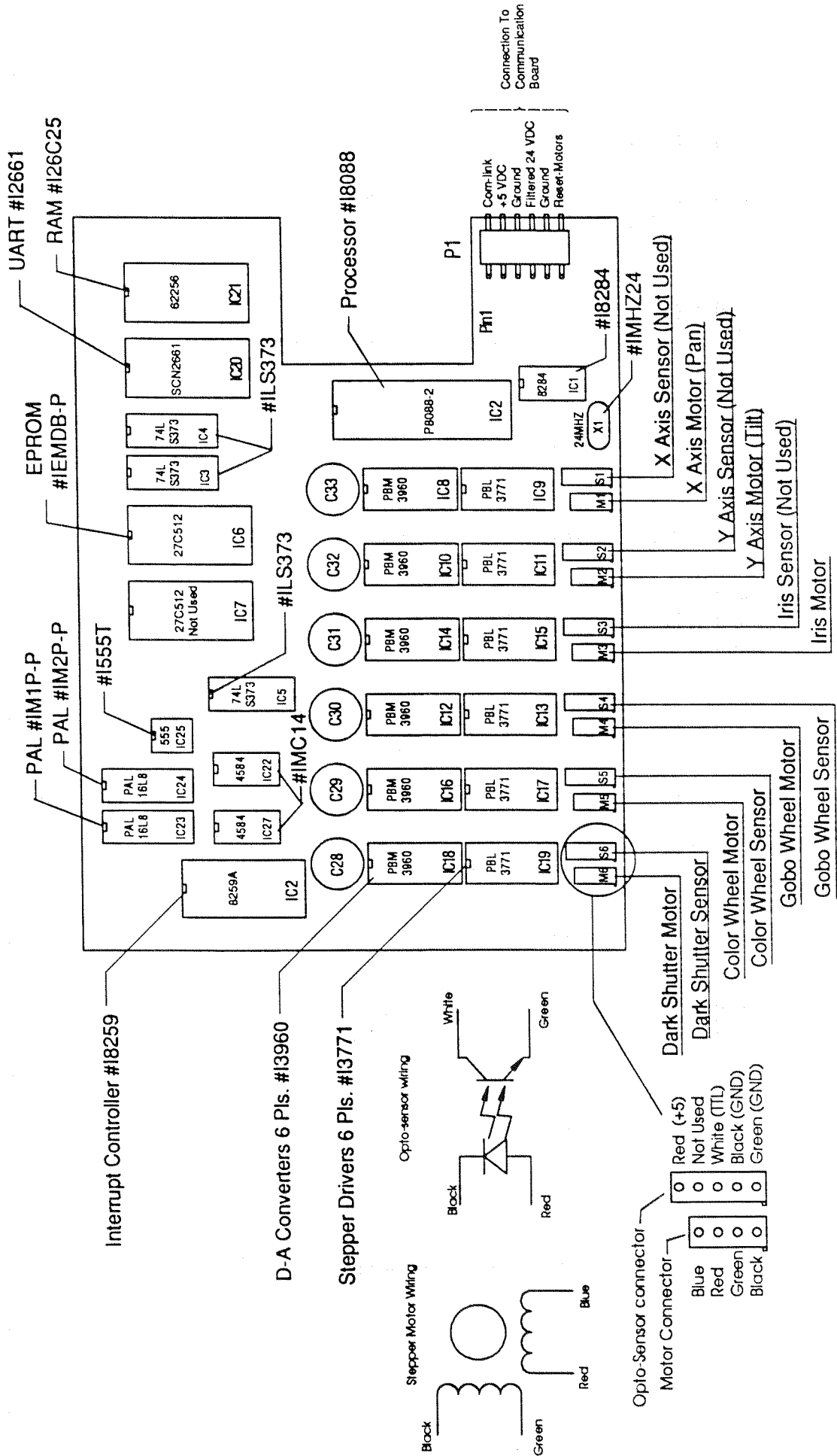

Figure 14. Motor Drive Board

**INTELLABEAM
Revision 1.0**

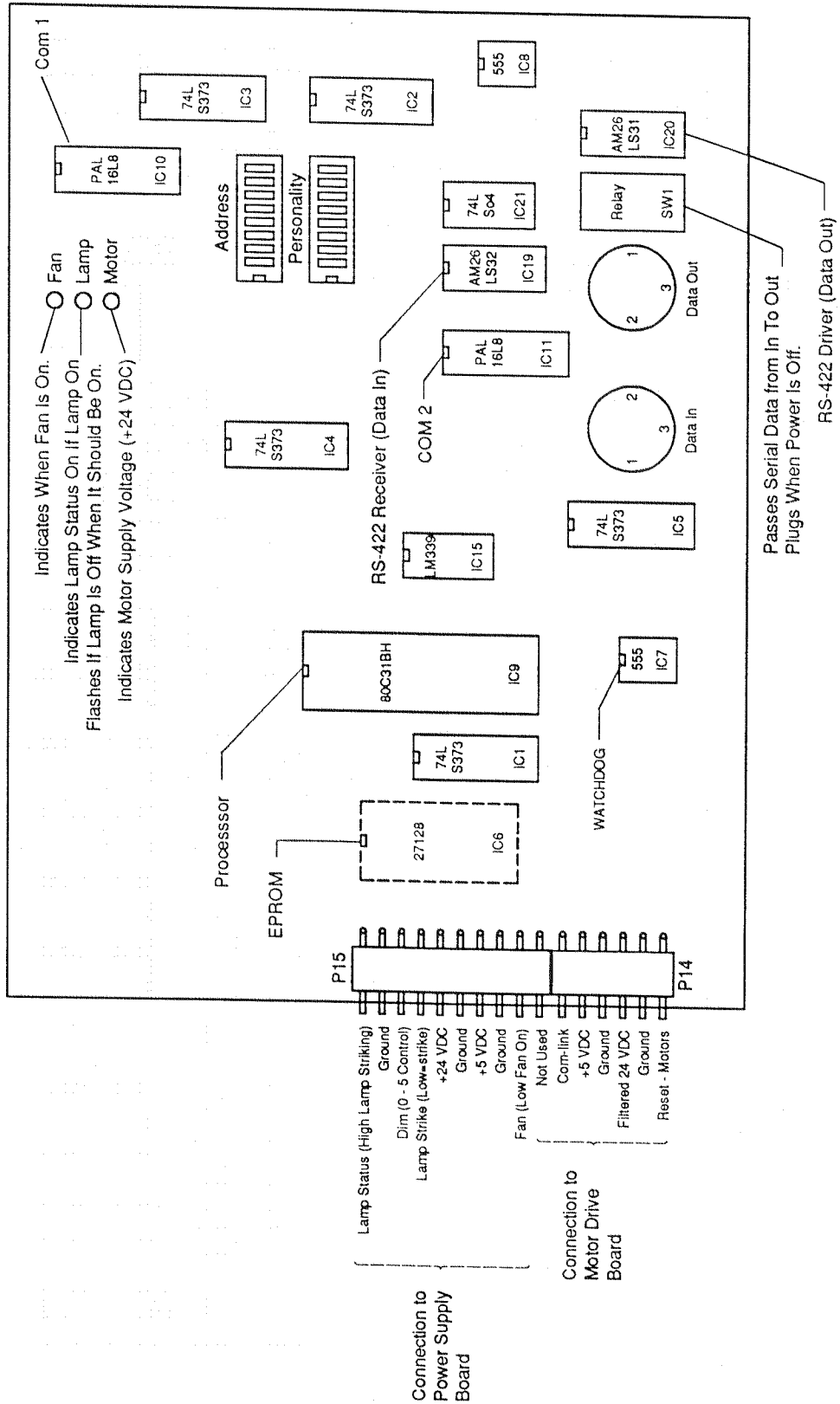

Figure 15. Fixture Communication Board

INTELLABEAM

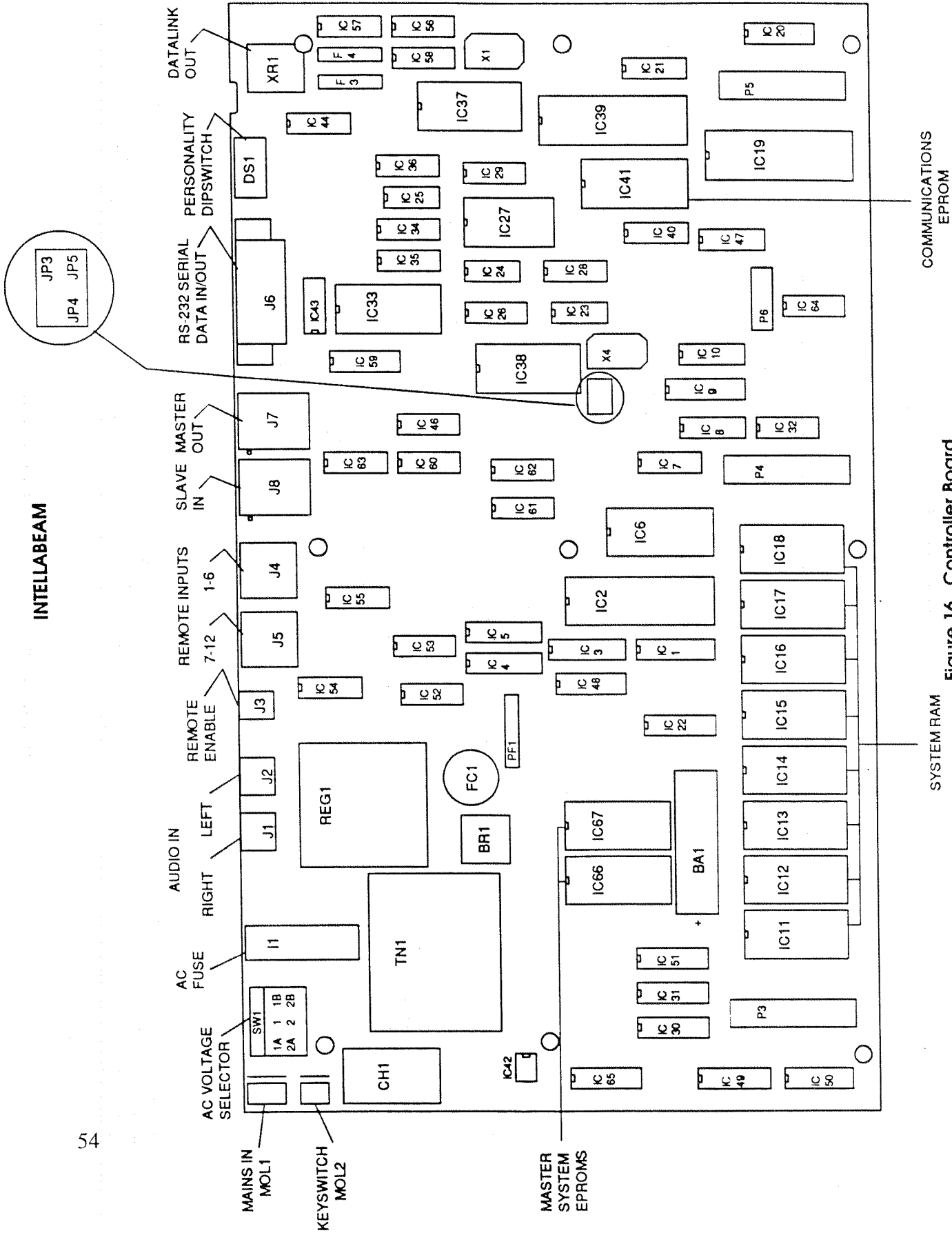

Figure 16. Controller Board

INTELLABEAM

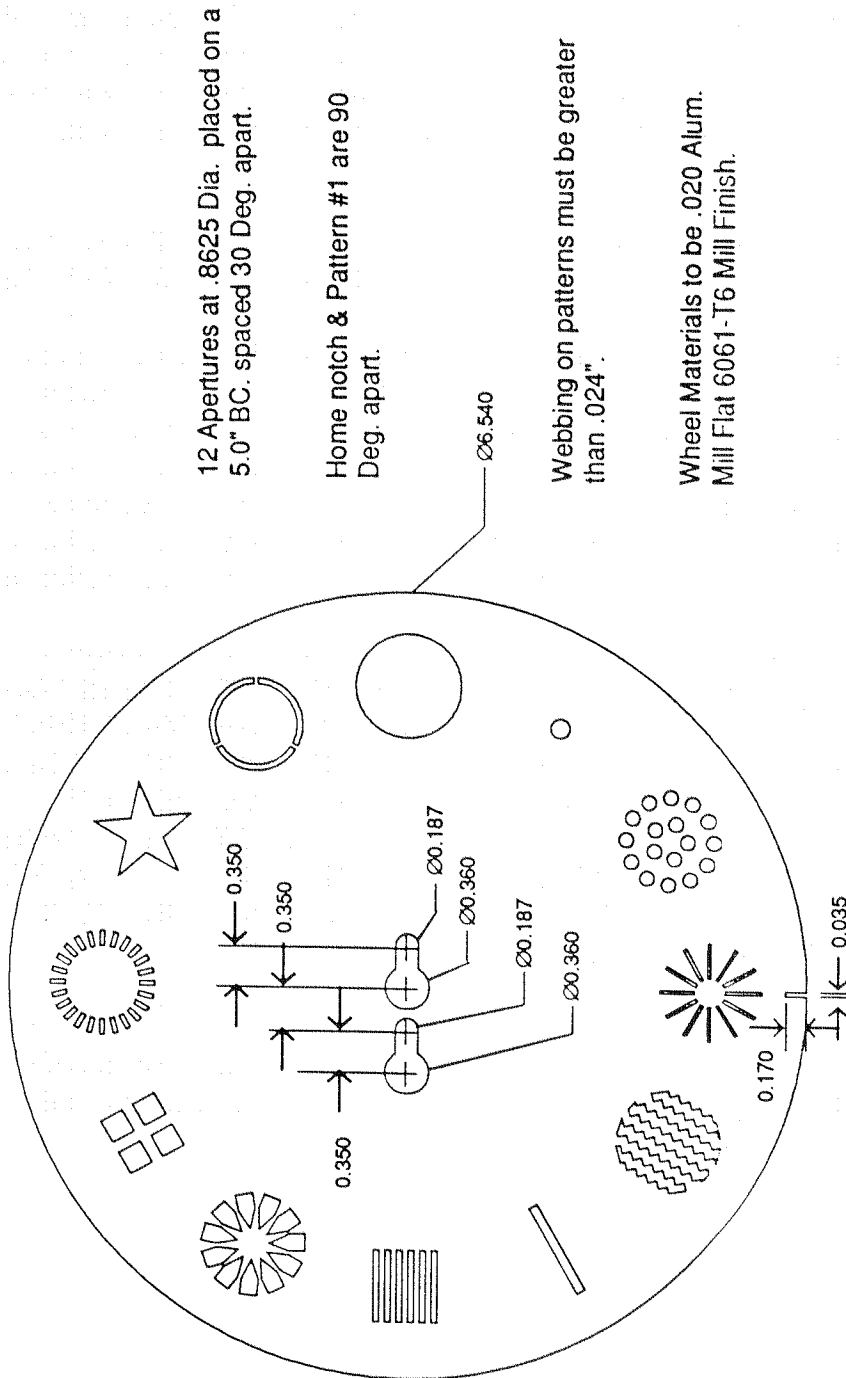

Figure 17. Gobo Wheel Specifications

WARRANTY TERMS AND CONDITIONS

The Intellabeam system is covered by a limited, 1 year parts and labor warranty. It is the owner's responsibility to furnish receipts or invoices for proof of purchase, purchase date, and dealer name. If unable to produce such proof, date of manufacture will determine warranty duration. It is necessary to obtain a return authorization number (R.A. #) **BEFORE** any units are sent in for repair. The manufacturer will make the final determination of warranty coverage. This warranty does not cover lamps, fuses, or glass parts.

ALL ITEMS MUST BE RETURNED IN THEIR ORIGINAL PACKING OR SUITABLE CONTAINER TO BE ACCEPTED FOR WARRANTY REPAIRS!

Shipping charges are the purchaser's responsibility and all shipments to the manufacturer must be prepaid. Under no circumstances will freight collect shipments be accepted! Return shipment within the Continental United States for all warranty repairs will be paid by the manufacturer. Prepaid shipping does not include rush expediting such as air freight. Air freight can be sent customer collect in the Continental United States. Any damage incurred in shipping is the responsibility of the carrier. In the case of hidden damage, a claim should be made as soon as discovered and all packing retained for inspection.

REPAIR OR REPLACEMENT AS PROVIDED FOR UNDER THIS WARRANTY IS THE EXCLUSIVE REMEDY OF THE CONSUMER. LIGHTWAVE RESEARCH, INC. OR ITS AGENTS SHALL NOT BE LIABLE FOR ANY INCIDENTAL OR CONSEQUENTIAL DAMAGES FOR BREACH OF ANY EXPRESS OR IMPLIED WARRANTY ON THIS PRODUCT. EXCEPT TO THE EXTENT PROHIBITED BY APPLICABLE LAW, ANY IMPLIED WARRANTY OF MERCHANTABILITY OR FITNESS FOR A PARTICULAR PURPOSE ON THIS PRODUCT IS LIMITED IN DURATION TO THE DURATION OF THIS WARRANTY.

Warranty is void if the product is opened, misused, damaged, or modified in any way. This warranty gives you specific legal rights, and you may also have other rights which vary from state to state.

PRECAUTIONS

Please note on the fixture and the controller the various precautions.

CAUTION: Tighten the thumbscrews securely on both access doors.

WARNING: Lamp produces ultraviolet radiation. Prolonged exposure can cause skin and eye burns. Do not operate this unit near flammable materials. Remove power before re-lamping. Keep both units away from rain or moisture to reduce the risk of fire or electrical shock. These units are not for residential use and contain no user serviceable parts inside. Servicing must be conducted by the manufacturer or other qualified service personnel. For continued protection against fire, fuses must only be replaced by those with the specified voltage and current ratings.

GLOSSARY OF TERMS

ACTIVE ADDRESS

An Address that illuminates an LED in the Address/Preset display as Pages are advanced. This is an indication that an Address has been programmed on that particular page.

DARK PAGE

A Page that has been programmed with the Gate wheel in the closed position. A Dark Page is indicated by a "CL" in the C.T.P. display for the Gate.

DELAY

A time interval from .1 second to 99 seconds that must elapse before a Page advances to the next.

INITIALIZED PAGE

A Page in which any parameter has been programmed, including a dark Page.

NON-INITIALIZED PAGES

A Page which has been marked as the beginning or end of a loop. It can be created by depressing the Select key, followed by depressing the Erase key two times in succession. A Non-Initialized Page is indicated by a series of dashes in the display when any Address key is depressed (-.- -.- -.-). This Page is blank but is different than a Dark Page because it directs the Program back to the first Page in a loop. Non-Initialized Pages also refer to those that have not been programmed before.

XFADE

An abbreviated form of Crossfade. This refers to the smooth transition in Intensity and beam size available between Pages.

SPEED

The adjustable value used to specify how fast the mirror travels from one spot to the next (Page to Page). If the speed is set the same for all fixtures, regardless of the distance traveled, all beams will reach their destinations at the same time.

ADDRESS MODE

The mode of operation in which the controller has access to any one of twenty-four Addresses on the front panel. The Address/Preset key in the upper left hand corner of the controller toggles between the Address and the Preset mode.

PRESET MODE

The mode of operation in which the controller has access to any one of the twenty-four Presets on the front panel (288 Presets are available if the analog input port is used). The Address/Preset key in the upper left hand corner of the controller toggles between the Address and the Preset mode.