



AT&T 555-640-112
Issue 1
March 1996

MERLIN LEGEND®
Communications System
Releases 3.1 and 4.0

System Planning

Notice

Every effort was made to ensure that the information in this book was complete and accurate at the time of printing. However, information is subject to change.

See Appendix A, "Customer Support Information," for important information.

Your Responsibility for Your System's Security

Toll fraud is the unauthorized use of your telecommunications system by an unauthorized party, for example, persons other than your company's employees, agents, subcontractors, or persons working on your company's behalf. Note that there may be a risk of toll fraud associated with your telecommunications system, and if toll fraud occurs, it can result in substantial additional charges for your telecommunications services.

You and your System Manager are responsible for the security of your system, such as programming and configuring your equipment to prevent unauthorized use. The System Manager is also responsible for reading all installation, instruction, and system administration documents provided with this product in order to fully understand the features that can introduce risk of toll fraud and the steps that can be taken to reduce that risk. AT&T does not warrant that this product is immune from or will prevent unauthorized use of common-carrier telecommunication services or facilities accessed through or connected to it. AT&T will not be responsible for any charges that result from such unauthorized use. For important information regarding your system and toll fraud, see Appendix A, "Customer Support Information."

Federal Communications Commission Statement

This equipment has been tested and found to comply with the limits for a Class A digital device, pursuant to Part 15 of the FCC Rules. These limits are designed to provide reasonable protection against harmful interference when the equipment is operated in a commercial environment. This equipment generates, uses, and can radiate radio frequency energy and, if not installed and used in accordance with the instruction manual, may cause harmful interference to radio communications. Operation of this equipment in a residential area is likely to cause harmful interference, in which case the user will be required to correct the interference at his own expense. For further FCC information, see Appendix A, "Customer Support Information."

Canadian Department of Communications (DOC) Interference Information

This digital apparatus does not exceed the Class A limits for radio noise emissions set out in the radio interference regulations of the Canadian Department of Communications.

Le Présent Appareil Numérique n'émet pas de bruits radioélectriques dépassant les limites applicables aux appareils numériques de la class A prescrites dans le règlement sur le brouillage radioélectrique édicté par le ministère des Communications du Canada.

Trademarks

5ESS, ACCUNET, DEFINITY, and MERLIN LEGEND are registered trademarks and 4ESS, ACCULINK, AUDIX Voice Power, MLX-10, MLX-10D, MLX-10DP, MLX-16DP, MLX-20L, and MLX-28D are trademarks of AT&T in the U.S. and other countries.

Windows is a trademark and Microsoft® a registered trademark of Microsoft Corporation.
ProComm is a registered trademark of DataStorm Technologies, Inc.

Ordering Information

Call: AT&T GBCS Publications Fulfillment Center
Voice 1 800 457-1235 International Voice 317 361-5353
Fax 1 800 457-1764 International Fax 317 361-5355

Write: AT&T GBCS Publications Fulfillment Center
P.O. Box 4100
Crawfordsville, IN 47933

Order: Document No. AT&T 555-640-112
Comcode 107713653
Issue 1, March 1996

For more information about AT&T documents, refer to the section entitled, "Related Documents" in "About This Book."

Support Telephone Number

In the continental U.S., AT&T provides a toll-free customer helpline 24 hours a day. Call the AT&T Helpline at **1 800 628-2888** or your AT&T authorized dealer if you need assistance when installing, programming, or using your system. Consultation charges may apply. Outside the continental U.S., contact your local AT&T authorized representative.

AT&T Corporate Security

Whether or not immediate support is required, *all* toll fraud incidents involving AT&T products or services *should be reported* to AT&T Corporate Security at **1 800 821-8235**. In addition to recording the incident, AT&T Corporate Security is available for consultation on security issues, investigation support, referral to law enforcement agencies, and educational programs.

AT&T Fraud Intervention

If you *suspect you are being victimized* by toll fraud and you need technical support or assistance, call GBCS National Service Assistance Center at **1 800 628-2888**.

Warranty

AT&T provides a limited warranty on this product. Refer to "Limited Warranty and Limitation of Liability" in Appendix A, "*Customer Support Information*."

Contents

New Features and Enhancements

- Release 3.1 Enhancements xvii
 - Release 4.0 Enhancements xix
-

About This Book

- Intended Audience xxiii
 - How to Use This Book xxiii
 - Terms and Conventions Used xxiv
 - Security xxvi
 - Related Documents xxvii
 - How to Comment on This Document xxviii
-

1 Before You Begin

- Reviewing System Components 1-1
 - Confirming the Location of the Control Unit 1-2
 - Obtaining Telephone Company Information 1-6
 - Obtaining User Information 1-7
 - Obtaining a Floor Plan 1-9
-

2 Control Unit Configuration

- Planning Module Placement 2-1
- Recording System Operating Conditions 2-7
- Numbering the System 2-13

Contents

3	Lines/Trunks	
	■ Identifying Line/Trunk Jacks	3-2
	■ Selecting Line/Trunk Options	3-11
	■ Assigning Lines/Trunks	3-47
	■ Assigning Telephone Buttons	3-48

4	Features	
	■ Telephone and Extension Features	4-2
	■ Operator Features	4-12
	■ Group-Assigned Features	4-20
	■ System Features	4-31

5	Data Communications	
	■ Terminology	5-2
	■ About Data and Video Communications	5-4
	■ Planning Overview	5-19
	■ Assigning Extension Jacks	5-21
	■ Assigning Lines/Trunks to Data and Video Stations	5-26
	■ Assigning Features to Data Stations	5-34
	■ Creating Data Hunt Groups	5-39
	■ Digital Data/Video Stations	5-41

6	Modifications	
	■ Preparation	6-2
	■ Adding to the System	6-2

Contents

7 Upgrading

- Upgrading to Release 4.0 7-2
 - Release 4.0 Forms 7-4
-

A Customer Support Information

- Support Telephone Number A-1
 - Federal Communications Commission (FCC)
Electromagnetic Interference Information A-1
 - Canadian Department of Communications (DOC)
Interference Information A-2
 - FCC Notification and Repair Information A-2
 - Installation and Operational Procedures A-3
 - DOC Notification and Repair Information A-5
 - Renseignements sur la notification du ministère des
Communications du Canada et la réparation A-6
 - Security of Your System: Preventing Toll Fraud A-9
 - Toll Fraud Prevention A-10
 - Other Security Hints A-15
 - Limited Warranty and Limitation of Liability A-19
 - Remote Administration and Maintenance A-21
-

B System Forms B-1

C Data Forms C-1

Contents

D	T1/PRI Review	D-1
----------	----------------------	-----

E	DS1 Connectivity Ordering	E-1
----------	----------------------------------	-----

F	Unit Load Calculation	
	■ Unit Load Rules	F-1
	■ Calculating Unit Loads	F-2
	■ Unit Load Worksheet	F-2

G	NI-1 BRI Review	G-1
----------	------------------------	-----

H	NI-1 BRI Provisioning	
	■ AT&T 5ESS Switch Translations	H-2
	■ Northern Telecom DMS-100 Switch Translations	H-19
	■ Siemens SSC EWSD Switch Translations	H-30

	Glossary	GL-1
--	-----------------	------

	Index	IN-1
--	--------------	------

Figures

1 Before You Begin

1-1. Floor Plan	1-10
-----------------	------

2 Control Unit Configuration

2-1. Sample Control Unit Diagram	2-6
2-2. Extension Numbers for 2-Digit Numbering Plan	2-28
2-3. Extension Numbers for 3-Digit Numbering Plan	2-29
2-4. Extension Numbers for Set Up Space Numbering Plan	2-30

3 Lines/Trunks

3-1. Partially Completed System Form 2c	3-8
3-2. Factory-Set Assignment, MLX Telephones (Hybrid/PBX Mode)	3-49
3-3. Factory-Set Assignment, Analog Multiline Telephones (Hybrid/PBX Mode)	3-50
3-4. Factory-Set Assignment, MLX Telephones (Key and Behind Switch Modes)	3-54
3-5. Factory-Set Assignment, Analog Multiline Telephones (Key and Behind Switch Modes)	3-55
3-6. MLX Direct-Line Console	3-59
3-7. Analog Direct-Line Console	3-60

Figures

4 Features

4-1.	Completed ARS Worksheet	4-50
4-2.	Example 1: Form 3f, 6-Digit Table	4-53
4-3.	Example 2: Form 3f, Area Code Table	4-54
4-4.	Subpattern Example	4-57
4-5.	Other Digits Example	4-58
4-6.	Digit Absorption Example	4-60

5 Data Communications

5-1.	Analog Voice and Modem Data	5-7
5-2.	Modem Data-Only	5-8
5-3.	MLX Voice and Modem Data	5-9
5-4.	MLX Voice and ISDN Terminal Adapter Data	5-11
5-5.	ISDN Terminal Adapter Data-Only	5-12
5-6.	Personal and Group Video	5-18

D T1/PRI Review

D-1.	Sample Network Planning Map	D-4
------	-----------------------------	-----

Tables

1 Before You Begin

1-1.	Environmental Requirements	1-2
1-2.	Control Unit Space Requirements	1-3
1-3.	Employee Communications Survey: Description of Questions	1-8

2 Control Unit Configuration

2-1.	Application Ports	2-15
2-2.	Modules with Touch-Tone Receivers	2-16
2-3.	Touch-Tone Receivers Required by Voice Messaging Systems	2-17
2-4.	System Requirements for Touch-Tone Receivers	2-17
2-5.	Maximum Number of Operator Positions	2-19
2-6.	Application Ports	2-26

3 Lines/Trunks

3-1.	Line/Trunk Jack Types	3-3
3-2.	Codes for Line/Trunk Jacks	3-5
3-3.	Line Compensation Settings	3-24
3-4.	Line Compensation Settings (Based on 22-Gauge Cable)	3-29
3-5.	Total Number of TTRs Required	3-46

4 Features

4-1.	Features That Can Be Copied	4-9
------	-----------------------------	-----

Tables

5 Data Communications

5-1.	Data Station Configurations	5-13
5-2.	Data Forms	5-19
5-3.	Forms	5-20
5-4.	Extension Jack Types	5-21

6 Modifications

6-1.	Required Line/Trunk and/or Extension Modules	6-3
6-2.	Adding New Trunks	6-6
6-3.	Adding Auxiliary Equipment	6-6
6-4.	Adding New Extensions	6-6

7 Upgrading

7-1.	Programming Compatibility	7-3
7-2.	Planning Forms	7-5

B System Forms

B-1.	Forms	B-1
------	-------	-----

C Data Forms

C-1.	Forms	C-1
------	-------	-----

Tables

E DS1 Connectivity Ordering

E-1. Guide to DS1 Connectivity Ordering

E-1

Tables



The exclamation point in an equilateral triangle is intended to alert the user to the presence of important operating and maintenance (servicing) instructions in the literature accompanying the product.

IMPORTANT SAFETY INSTRUCTIONS

When installing telephone equipment, always follow basic safety precautions to reduce the risk of fire, electrical shock, and injury to persons, including:

- Read and understand all instructions.
- Follow all warnings and instructions marked on or packed with the product.
- Never install telephone wiring during a lightning storm.
- Never install a telephone jack in a wet location unless the jack is specifically designed for wet locations.
- Never touch uninsulated telephone wires or terminals unless the telephone wiring has been disconnected at the network interface.
- Use caution when installing or modifying telephone lines.
- Use only AT&T-manufactured MERLIN LEGEND Communications System circuit modules, carrier assemblies, and power units in the MERLIN LEGEND Communications System control unit.
- Use only AT&T-recommended/approved MERLIN LEGEND Communications System accessories.
- If equipment connected to the analog extension modules (008, 408, 408 GS/LS) or to the MLX telephone modules (008 MLX, 408 GS/LS-MLX) is to be used for in-range out-of-building (IROB) applications, IROB protectors are required.
- Do not install this product near water, for example, in a wet basement location.
- Do not overload wall outlets, as this can result in the risk of fire or electrical shock.
- The MERLIN LEGEND Communications System is equipped with a 3-wire grounding-type plug with a third (grounding) pin. This plug will fit only into a grounding-type power outlet. This is a safety feature. If you are unable to insert the plug into the outlet, contact an electrician to replace the obsolete outlet. Do not defeat the safety purpose of the grounding plug.
- The MERLIN LEGEND Communications System requires a supplementary ground.

- Do not attach the power supply cord to building surfaces. Do not allow anything to rest on the power cord. Do not locate this product where the cord will be abused by persons walking on it.
- Slots and openings in the module housings are provided for ventilation. To protect this equipment from overheating, do not block these openings.
- Never push objects of any kind into this product through module openings or expansion slots, as they may touch dangerous voltage points or short out parts, which could result in a risk of fire or electrical shock. Never spill liquid of any kind on this product.
- Unplug the product from the wall outlet before cleaning. Use a damp cloth for cleaning. Do not use cleaners or aerosol cleaners.
- Auxiliary equipment includes answering machines, alerts, modems, and fax machines. To connect one of these devices, you must first have a Multi-Function Module (MFM).
- Do not operate telephones if chemical gas leakage is suspected in the area. Use telephones located in some other safe area to report the trouble.



WARNING:

- *For your personal safety, DO NOT install an MFM yourself.*
- *ONLY an authorized technician or dealer representative shall install, set options, or repair an MFM.*
- *To eliminate the risk of personal injury due to electrical shock, DO NOT attempt to install or remove an MFM from your MLX telephone. Opening or removing the module cover of your telephone may expose you to dangerous voltages.*

SAVE THESE INSTRUCTIONS

New Features and Enhancements

Release 3.1 Enhancements

Release 3.1 includes all Release 3.0 functionality plus the enhancements listed below.

- **Call Restriction checking for star codes**

Beginning with Release 3.1, the system manager can now add star (*) codes to Allowed and Disallowed Lists to help prevent toll fraud. Star codes, typically dialed before an outgoing call, enable telephone users to obtain special services provided by the central office (CO). For example, in many areas, a telephone user can dial *67 before a telephone number to disable central office-supplied caller identification at the receiving party's telephone. (You must contract with your telephone service provider to have these codes activated.)

When users dial star codes, the MERLIN LEGEND system's Calling Restrictions determine whether the codes are allowed. If allowed, the system's Calling Restrictions are reset, and the remaining digits that the users dial are checked against the Calling Restrictions.

- **Trunk-to-Trunk Transfer on a per-station basis**

This enhancement to the trunk-to-trunk feature enables the system manager to allow or disallow trunk-to-trunk transfer *on a per-station basis*. Beginning with Release 3.1, the default setting for all stations is restricted.

- **Programmable Second Dial Tone Timer**

Beginning with Release 3.1, the system manager can now assign a second dial tone timer to lines and trunks to help prevent toll fraud (for example, when star codes are used). After receiving certain digits dialed by a user, the CO may provide a second dial tone, prompting the user to enter more digits. If this second dial tone is delayed, and the user dials digits before the CO provides the second dial tone, there is a risk of toll fraud or the call being misrouted. The second dial tone timer enables the system manager to make sure that the CO is ready to receive more digits from the caller.

- **A Disallowed List containing numbers frequently associated with toll fraud**

Beginning with Release 3.1, Disallowed List #7 now contains default entries, which are numbers frequently associated with toll fraud. By default, Disallowed List #7 is automatically assigned to both generic and integrated VMI ports used by voice messaging systems. The system manager must manually assign this list to other ports.

- **Pool Dial-Out Code restriction for all extensions by default**

Beginning with Release 3.1, the default setting for the Pool Dial-Out Code restriction has changed to restricted. No extension or remote access user with a barrier code has access to pools until the restriction is removed by the system manager.

- **Outward restrictions for VMI ports by default**

Beginning with Release 3.1, ports assigned for use by voice messaging systems (generic or integrated VMI ports) are now assigned outward restrictions by default. If a voice messaging system should be allowed to call out (for example, to send calls to a user's home office), the system manager must remove these restrictions.



Security Alert:

Before removing restrictions, it is strongly recommended that you read "Appendix A: Customer Support Information."

- **New default Facility Restriction Level (FRL) for VMI ports**

Beginning with Release 3.1, the default FRL for VMI ports has changed to 0, restriction all outcalling.

- **New default FRL for the Default Local Route Table**

Beginning with Release 3.1, the default FRL has changed to 2 for the Default Local Route Table. Now, system managers can easily change an extension default of 3 to 2 or lower in order to restrict calling. No adjustment to the route FRL is required.

- **New maintenance procedure for testing outgoing trunk problems**

A password is now required for technicians to perform trunk tests.



Security Alert:

The enhancements in Release 3.1 help increase the security of the MERLIN LEGEND System. To fully utilize these security enhancements, be sure to read and understand the information in these upgrade notes.

Release 4.0 Enhancements

Release 4.0 includes all Release 3.1 functionality plus the enhancements listed below:

- **Support for up to 200 stations**

Release 4.0 has an expanded dial plan that supports up to 200 tip/ring devices.

- **New 016 tip/ring module**

This new module supports the 200 station dial plan by providing sixteen ports for tip/ring devices. Applications that use a tip/ring interface can connect to this board. All sixteen ports can ring simultaneously. Four touch-tone receivers (TTRs) are included on the module as well. The module's ringing frequency (default 20 Hz) can be changed through programming to 25 Hz for those locations that require it.

- **Support for National ISDN BRI Service**

This service provides a low-cost alternative to loop-start and ground-start trunks for voice and digital data connectivity to the Central Office. Each of the two B (bearer)- channels on a BRI line can carry one voice or one data call at any given time. The data speeds on a B-channel are up to 14.4 kbps for analog data and up to 64 kbps for digital data, which is necessary for video conferencing and other video applications. Release 4.0 supports the IOC Package "S" (basic call handling) service configuration and Multi-Line Hunt service configuration on designated CO switches.

- **New 800 NI-BRI module**

This new module connects NI-1 BRI trunks to the MERLIN LEGEND system for high-speed data and video transmission.

■ **Support for 2B Data applications**

Release 4.0 has certified group and desktop video applications that use two B-channels to make video/data calls from endpoints (stations) that are enabled to use 2B Data. The endpoints that support these applications connect to an MLX-port on the MERLIN LEGEND system. 2B Data applications can make use of the NI-1 BRI, PRI, or T1 Switched 56 network interfaces to make outside connections using one or two data channels at a time.

■ **Support for T1 digital data transmission**

Release 4.0 expands its T1 functionality by providing access to digital data over the public switched 56 kbps network in addition to data Tie-Trunk services. Users who have T1 facilities for voice services can now use them for video calls at data rates of 56 kbps per channel (112 kbps for video calls using two channels). The Release 4.0 T1 offering also includes point-to-point connectivity over T1 Tie-trunks, allowing customers to connect two MERLIN LEGEND Communications Systems or a MERLIN LEGEND Communications System with a DEFINITY® Communications System. The two communications systems can be co-located or off-premises.

■ **Delayed Call Forwarding**

Each user can program a Forwarding Delay setting for the Forward, Remote Call Forwarding, or Follow Me features. The forwarding delay is the number of times that a call rings at the forwarding extension before the call is sent to the receiver. During the delay period, the user can screen calls by checking the displayed calling number (if it is available). The delay can be set at 0 to 9 rings. The factory setting for Forwarding Delay is 0 rings (no delay).

■ **Voice Announce on the QCC**

The QCC operator can enable the fifth **Call** Button to announce a call on another user's speakerphone if the destination telephone has a Voice Announce capable **SA** button available. A QCC cannot receive Voice Announce calls; they are received as ringing calls. The factory-set status for the fifth **Call** Button is to have Voice Announce disabled.

■ **Time-based option for overflow on Calling Group**

Release 4.0 has added a *time* limit for calls in queue in addition to the previous *number* limit. If the Overflow Threshold Time is set to a valid number between 1–900 seconds, calls that remain in the Calling Group Queue for the set time are sent to the Overflow Receiver. If the Overflow Threshold Time is set to 0, Overflow by time is turned off. The factory-set time limit is 0 seconds (Overflow by time off).

■ **Downloadable Firmware for 016 T/R board and the NI-BRI board.**

The PCMCIA technology introduced in Release 3.0 continues to support these two new boards in Release 4.0 for installation and upgrade. A Release 3.0 or later processor is required for PCMCIA technology.

■ **Single-Line Telephone Enhancements**

- **Disable Transfer.** Through centralized telephone programming, the system manager can disable the ability to transfer calls by removing all but one **SA** or **ICOM** button from the telephone.
- **No Transfer Return.** When a handset bounce in its cradle, the MERLIN LEGEND system interprets that as a switchhook flash and attempts to transfer a call. When the transfer attempt period expires, the user's telephone rings. Release 4.0 eliminates this unintended ringing by disconnecting the call in situations where a switchhook flash is followed by an on-hook state when dial tone is present.
- **Forward Disconnect.** All ports on 012 and 016 modules now send forward disconnect to all devices connected to them when forward disconnect is received from the CO. This enhancement prevents the trunk/line from being kept active when one end disconnects from the call. If an answering machine is connected to the port, it will not record silence, or busy tones, or other useless messages. This is a non-administrable operation.

■ **7-digit password for SPM**

Release 4.0 has increased system security by requiring a 7-digit password when using SPM to perform remote administration or when performing the Trunk Test procedure. This password is to be used in addition to the Remote Access barrier codes.

About This Book

The MERLIN LEGEND Communications System is an advanced digital switching system that integrates voice and data communications features. Voice features include traditional telephone features, such as Transfer and Hold, and advanced features, such as Group Coverage and Park. Data features allow both voice and data to be transmitted over the same system wiring.

Intended Audience

This book provides detailed information about system planning. It is intended for use by anyone who works with customers to plan, coordinate, and implement a system, including support personnel, sales representatives, and account executives. It is also intended for technicians who are responsible for system installation, maintenance, and troubleshooting.

How to Use This Book

This book has been designed to provide optimal assistance to you in completing the planning forms, for example:

1. Since some chapters and/or sections apply to one or another of the configurations (Key or Behind Switch, Hybrid/PBX, or data communications), these sections are clearly marked, for example, "Hybrid/PBX mode only." Also, you are alerted to proceed or skip chapters or sections that don't apply to your particular system. Proceed through the book as appropriate.
2. A list of the forms or information that will be needed for particular procedures appears at the beginning of each chapter and section.
3. Where appropriate, examples of completed forms are included so you can confirm what you have done.

Since this book assumes that you are familiar with the system, detailed information about equipment, features, and programming are not included. Refer to the following documentation for additional information:

- *Equipment and Operations Reference* provides detailed information on system hardware, telephones, and other equipment.
- *System Programming* gives procedural instructions for programming system features.
- User's guides and operator's guides give procedural instructions for programming and using telephone features.

"Related Documents," later in this section, provides a complete list of system documentation together with ordering information.

In the U.S.A. only. AT&T provides a toll-free customer Helpline (1-800-628-2888) 24 hours a day. Call the Helpline, or your AT&T representative, if you need assistance when installing, programming, or using your system.

Terms and Conventions Used

The terms described here are used in preference to other, equally acceptable terms for describing communications systems.

Lines, Trunks, and Facilities

Facility is a general term that designates a communications path between a telephone system and the telephone company central office. Technically a trunk connects a switch to a switch, for example the MERLIN LEGEND Communications System to the central office. Technically, a line is a loop-start facility or a communications path that does not connect two switches, for example, an intercom line or a Centrex line. However, in actual usage, the terms *line* and *trunk* are often applied interchangeably. In this book, we use *line/trunk* and *lines/trunks* to refer to facilities in general. Specifically, we refer to *digital facilities*. We also use terms such as *personal line*, *ground-start trunk*, *DID trunk*, and so on. When you talk to your local telephone company central office, ask them what terms they use for the specific facilities they connect to your system.

Some older terms have been replaced with newer terms. The following list shows the old term on the left and the new term on the right.

trunk module	line/trunk module
trunk jack	line/trunk jack
station	extension
station jack	extension jack
analog data station	modem data station
7500B data station	ISDN terminal adapter data station
analog voice and analog data station	analog voice and modem data
digital voice and analog data station	MLX voice and modem data

analog data-only station
7500B data-only station
MLX voice and 7500B data station

modem data-only station
ISDN terminal adapter data-only station
MLX voice and ISDN terminal adapter
data station

Typographical Conventions

Certain type fonts and styles act as visual cues to help you rapidly understand the information presented:

Example	Purpose
It is <i>very</i> important that you follow these steps. You <i>must</i> attach the wristband before touching the connection.	Italics indicate emphasis.
The part of the headset that fits over one or both ears is called a <i>headpiece</i> .	Italics also set off special terms.
If you press the Feature button on an MLX display telephone, the display lists telephone features you can select. A programmed Auto Dial button gives you instant access to an inside or outside number.	The names of fixed-feature, factory-imprinted buttons appear in bold. The names of programmed buttons are printed as regular text.
Choose Ext Prog from the display screen.	Plain constant-width type indicates text that appears on the telephone display or PC screen.
To activate Call Waiting, dial <i>*11</i> .	Constant-width type in italics indicates characters you dial at the telephone or type at the PC.

Product Safety Labels

Throughout these documents, hazardous situations are indicated by an exclamation point inside a triangle and the word *caution* or *warning*.



WARNING:

Warning indicates the presence of a hazard that could cause death or severe personal injury if the hazard is not avoided.



CAUTION:

Caution indicates the presence of a hazard that could cause minor personal injury or property damage if the hazard is not avoided.

Security

Certain features of the system can be protected by passwords to prevent unauthorized users from abusing the system. You should assign passwords wherever you can and limit knowledge of such passwords to three or fewer people.

Nondisplaying authorization codes and telephone numbers provide another layer of security. For more information, see Appendix A, "Customer Support Information."

Throughout this document, toll fraud security hazards are indicated by an exclamation point inside a triangle and the words Security Alert.



Security Alert:

Security Alert indicates the presence of toll fraud security hazard. Toll fraud is the unauthorized use of your telecommunications system by an unauthorized party (e.g., persons other than your company's employees, agents, subcontractors, or persons working on your company's behalf). Be sure to read "Your Responsibility for Your System's Security" on the inside front cover of this book and "Security of Your System: Preventing Toll Fraud" in Appendix A, "Customer Support Information."

Related Documents

In addition to this book, the documents listed below are part of the documentation set. Within the continental United States, these documents can be ordered from the AT&T GBCS Publications Fulfillment Center by calling 1 800 457-1235.

Document No.	Title
	System Documents
555-640-110	<i>Feature Reference</i>
555-640-111	<i>System Programming</i>
555-640-112	<i>System Planning</i>
555-640-113	<i>System Planning Forms</i>
555-640-116	<i>Pocket Reference</i>
555-640-118	<i>System Manager's Guide</i>
	Telephone User Support
555-640-122	<i>MLX-10D™, MLX-10DP™, MLX-16DP™, MLX-28D™, and MLX-20L™ Display Telephones User's Guide</i>
555-630-150	<i>MLX-10D Display Telephone Tray Cards (5 cards)</i>
555-630-153	<i>MLX-28D and MLX-20L Telephone Tray Cards (5 cards)</i>
555-640-124	<i>MLX-10™ Nondisplay Telephone User's Guide</i>
555-630-151	<i>MLX-10 Nondisplay Telephone Tray Cards (6 cards)</i>
555-640-120	<i>Analog Multiline Telephones User's Guide</i>
555-640-126	<i>Single-Line Telephones User's Guide</i>
555-640-138	<i>MDC 9000 and MDW 9000 Telephones User's Guide</i>
	System Operator Support
555-640-134	<i>MLX Direct-Line Consoles Operator's Guide</i>
555-640-132	<i>Analog Direct-Line Consoles Operator's Guide</i>
555-640-136	<i>MLX Queued Call Console Operator's Guide</i>
	Miscellaneous User Support
555-640-130	<i>Calling Group Supervisor's Guide</i>
555-640-105	<i>Data and Video Reference</i>
	Documentation for Qualified Technicians
555-640-140	<i>Installation, Programming, & Maintenance (IP&M) Binder [consists of Installation, System Programming & Maintenance (SPM), Maintenance & Troubleshooting]</i>
	Toll Fraud Security
555-025-600	<i>GBCS Products Security Handbook</i>

How to Comment on This Document

We welcome your comments, both good and bad. Please use the feedback form on the next page to let us know how we can continue to serve you. If the feedback form is missing, write directly to:

Documentation Manager
AT&T
211 Mount Airy Road, Room 2W226
Basking Ridge, NJ 07920

FEEDBACK FORM
MERLIN LEGEND® Communications System Release 4.0

Title: System Planning
 Order No.: **555-640-112** Date: **March 1996, Issue 1**

1. Please rate the effectiveness of this book in the following areas:

	Excellent	Good	Fair	Poor	Not Applicable
Ease of Use					
Clarity					
Completeness					
Accuracy					
Organization					
Appearance					
Examples					
Illustrations					
Overall Satisfaction					

2. Please check ways you feel we could improve this book:

- | | | |
|--|---|---|
| <input type="checkbox"/> Improve the overview | <input type="checkbox"/> Add more examples | <input type="checkbox"/> Add troubleshooting information |
| <input type="checkbox"/> Improve the table of contents | <input type="checkbox"/> Add more detail | <input type="checkbox"/> Make it less technical |
| <input type="checkbox"/> Improve the organization | <input type="checkbox"/> Make it more concise | <input type="checkbox"/> Add more/better quick reference aids |
| <input type="checkbox"/> Include more illustrations | <input type="checkbox"/> Add more step-by-step procedures | <input type="checkbox"/> Improve the index/glossary |
| <input type="checkbox"/> Other _____ | | |

3. What did you like most about this book?

4. Feel free to write any comments below or on an attached sheet.

If we may contact you about your comments, please complete the following:

Name: _____ Telephone Number: _____

Company/Organization: _____ Date: _____

Address: _____

Send completed forms to: Documentation Manager, AT&T, 211 Mount Airy Road,
 Room 2W226, Basking Ridge, NJ 07920. Fax: (908) 953-6912.

THIS FORM MAY BE PHOTOCOPIED

Before You Begin

1

Contents

Reviewing System Components	1-1
Confirming the Location of the Control Unit	1-2
■ Grounding Requirements	1-4
■ Electrical Noise/Radio-Frequency Interference	1-5
Obtaining Telephone Company Information	1-6
Obtaining User Information	1-7
Obtaining a Floor Plan	1-9

Before You Begin

1

You should perform several tasks before you begin filling out the planning forms for the system:

1. Review the system's hardware, features, and operation as defined at the time of purchase.
2. Confirm the location of the control unit.
3. Obtain the required information from the local telephone company.
4. Obtain information about telephone users and their needs.
5. Obtain or develop a floor plan of the customer's site.

Each of these preplanning tasks is described in this chapter.

Reviewing System Components

To tailor the system to the customer's business, you must know the number and types of telephones, outside lines/trunks, and adjuncts that were ordered. You also need to know how the equipment will be used, for example, which type of telephone is assigned to each employee, which consoles operators will be using, and where adjuncts will be located.

Review the list of equipment ordered. If you did not participate in the ordering process, you may want to confer with the customer representative who did. You also may want to conduct a premises check to determine whether any additional equipment is required.

Confirming the Location of the Control Unit

Before installation, a room, closet, or other area must be designated where the system control unit can be mounted on the wall. The area must meet the environmental requirements in Table 1–1.

Table 1–1. Environmental Requirements

Conditions	Requirements
Distances	Within 25 cable feet (7.6 m) of the network interface (cannot be installed outdoors) Within 1000 cable feet (304.8 m) of telephones Within 5 cable feet (1.5 m) of a dedicated AC power outlet (1 outlet for every carrier)
Heat Dissipation	Fully loaded basic carrier: 500 Btu/hr (35 cal/sec) Fully loaded 2-carrier: 1000 Btu/hr (70 cal/sec) Fully loaded 3-carrier: 1500 Btu/hr (105 cal/sec)
Power	Basic carrier: 117 VAC 60 Hz \pm 5% 160 W 3 amps 2-carrier: 117 VAC 60 Hz \pm 5% 320 W 6 amps 3-carrier: 117 VAC 60 Hz \pm 5% 480 W 9 amps 1 properly grounded outlet needed for each carrier Additional outlets may be needed if installing printers and PCs.
Temperature	40° through 104°F; 4° through 40°C (optimal temperature 60°F; 16°C)
Humidity	20% through 80% relative humidity
Ventilation	Allow at least 1 in. (2.5 cm) of space on the right and left sides of the control unit and 12 in. (30.5 cm) above and below the control unit to prevent overheating.



CAUTION:

The AC outlet for the control unit should not be switch-controlled. Plugging the control unit into an outlet that can be turned on and off by a switch can cause accidental disconnection of the system.

The AC outlet must be properly grounded by using an AC receptacle for a 3-prong plug.

Do not install the control unit outdoors.

Do not place the control unit near extreme heat (furnaces, heaters, attics, or direct sunlight).

Do not expose the control unit to devices that generate electrical interference (such as arc welders or motors).

Do not expose the control unit to moisture, corrosive gases, dust, chemicals, spray paint, or similar material.

Do not place anything on top of the carriers.

Do not install under any device that may drip fluid, such as an air conditioner.

In addition, a backboard is needed to mount the system on the wall. One can be made locally from 0.75-in. (1.9-cm) plywood. The dimensions depend on the number of carriers, as shown in Table 1–2. A newly designed pre-drilled, light-weight plastic backboard may be ordered (COMCODE 847007523). In some areas, fire or electrical codes require a flame-retardant backboard. Check with the appropriate authorities to ensure that the proper material is provided. A template is available (COMCODE 847009206). It shows the layout for mounting equipment. It also comes with safety, electrical, environmental, and space requirements for the communications system.

Table 1–2. Control Unit Space Requirements

Carrier	Requirements
Basic carrier	14" w by 23" h by 12" d (35.6 cm by 58.4 cm by 30.5 cm)
Basic carrier + 1 expansion carrier	25" w by 23" h by 12" d (63.5 cm by 58.4 cm by 30.5 cm)
Basic carrier + 2 expansion carriers	37" w by 23" h by 12" d (94 cm by 58.4 cm by 30.5 cm)
Backboard	
Without Systimax™	6' w by 3' h by 0.75" d (182.9 cm by 91.4 cm by 1.9 cm)
With Systimax	7' w by 4' h by 0.75" d (213.4 cm by 121.9 cm by 1.9 cm)

It is important that the location selected for the control unit meets all of these specifications and that the backboard is in place before installation. If the location has already been selected and changes are needed, arrange for these changes before installation.

Information about optional backup power and batteries is contained in the *Equipment and Operations Reference*.

Grounding Requirements

Proper grounding of the installation site is essential for correct and safe functioning of the system. Grounding protects the system against:

- Lightning
- Power surges
- Power crosses on outside lines/trunks
- Electrostatic discharge (ESD)

The telephone company is responsible for providing protection of outside lines/trunks at the entrance to the site. The protection should consist of:

- Carbon blocks or gas-discharge tubes connected to an approved ground
- Adequate bonding of the outside line/trunk protector ground and the power-company ground



CAUTION:

Improper ground can result in equipment failures and service outages. Verify that the AC power uses an approved ground for its primary ground and that all voltage-limiting devices are attached to an approved ground. Approved grounds are as follows:

- *The metal frame of the building*
- *A metal water pipe connected to an underground water pipe that is in direct contact with earth*
- *An electrode encased by at least 2 inches of concrete and located within and near the bottom of a concrete foundation or footing in direct contact with earth*
- *A copper ring that encircles a building and is in direct contact with earth*

For most surge occurrences, the following standard grounding requirements provide adequate lightning and power surge protection:

- Properly wired, grounded, and bonded outside line protectors
- Properly wired and grounded AC outlet
- Properly grounded single-point ground bar
- Properly wired connection between single-point ground and power supply

Electrical Noise/Radio-Frequency Interference

In most cases, electrical noise is introduced to the system through lines/trunks or telephone cables. However, electromagnetic fields near the control unit may also induce noise in the system. Therefore, the control unit and cable runs should not be placed in areas where a high electromagnetic field strength exists. Radio transmitters (AM and FM), television stations, induction heaters, motors (with commutators) of 0.25 horsepower (200 watts) or greater, and similar equipment are leading causes of interference. Small tools with universal motors do not generally cause a problem when operated on separate power lines. Motors without commutators generally do not cause interference.

Field strengths below 1.0 volt per meter are unlikely to cause interference. Estimate the field strength produced by radio transmitters by dividing the square root of the emitted power (in kilowatts) by the distance from the antenna in kilometers.

This yields the approximate field strength in volts per meter and is relatively accurate for distances greater than about half a wavelength (492 feet, or 150 m, for a frequency of 1000 Hz).

To comply with FCC Part 15 requirements, each power supply on a newly installed system must have a ferrite core installed around the AC power cord and ground wire. Beginning with Release 2.1 this ferrite core is packaged with the power supply module at the factory. Ferrite cores are also compatible with earlier releases.

Obtaining Telephone Company Information

To fill out many of the forms, especially forms involving incoming lines/trunks, you will need to obtain information from the local telephone company. Before you speak with the local telephone company, make sure you understand your customer's company requirements regarding the communications system. Some of the information you will need to know includes:

- Which incoming line/trunk is connected to each channel on each 100D module, and the order in which the lines/trunks are assigned
- The Service Profile Identifier (SPID) and Directory Number (DN) associated with each channel on each 800 NI-BRI module.
- Whether the disconnect signals for loop-start lines/trunks are reliable or unreliable, and what the length of the Hold disconnect interval is

Information the local telephone company will be able to provide includes:

- Detailed T1 parameters
- Detailed NI-1 BRI parameters
- The number of digits sent on DID trunks
- Which lines/trunks, if any, require a toll-call prefix
- The telephone number for each incoming line/trunk
- The type(s) of incoming lines/trunks (loop-start, ground-start, and so on)
- Which lines/trunks, if any, are rotary-dial lines/trunks

Obtaining User Information

The features and calling privileges you assign to each employee's telephone ensure that employees get the most benefit from the system. If you were not involved in the planning and equipment-ordering for the system, you should discuss the design with the customer representative who took part.

To determine calling privileges, answer the following questions:

- Does management want to allow both local and toll calls to be made from every telephone?
- If any telephones are restricted, are there any numbers the users should be allowed to call?
- Are there any specific numbers (such as 900) that you want to restrict users from calling?
- Who, if anyone, will be given personal lines?
- Will access to central office lines/trunks (outside lines) be restricted to certain employees?
- Do any departments receive frequent special calls (such as sales and service) that should come to them directly, bypassing a system operator?
- Do any departments or extensions need to screen incoming calls?

You may want to use the Employee Communication Survey form to determine each employee's telecommunications needs. A copy of this form is in Appendix B and is included in the forms package. Since a survey form should be completed for each user, make as many copies of the form as you need.

If it is not feasible to have each employee fill out a form, get the information you need from a knowledgeable person in each department, section, or work group. This person should have sufficient information and authority to make decisions about calling features and coverage assignments for others in the department.

Use the information in Table 1-3 to interpret and analyze the results of the Employee Communication Survey. Numbers for items in the Required Information column correspond to question numbers on the survey.

Table 1-3. Employee Communications Survey: Description of Questions

Required Information	Description
1. Types of lines/trunks (outside lines) used	Indicates toll-calling habits. In most cases, assigning a button for each line/trunk is not necessary; the use of Automatic Route Selection (Hybrid/PBX mode only) ensures that the preferred line/trunk is selected.
2. Calls covered by someone else (sender)	Suggests that this employee should be assigned as a sender in either an Individual or a Group Coverage arrangement, particularly if calls are covered by someone other than the operator.
3. Shares lines/telephone numbers	Identifies Shared System Access buttons and/or common personal line appearances.
4. Covers someone else's calls (receiver)	Suggests assignment as a receiver in someone else's Individual or Group Coverage arrangements.
5. Shares incoming calls	Identifies calling group needs.
6. Frequency of use	Identifies heavy and light telephone users. Heavy users may benefit from additional System Access buttons and/or an additional System Access Originate Only button.
7. Data needs	Identifies existing and potential data terminal and personal computer users.
8. Use of account codes	Identifies current account codes used for charge-back of calls if there is a programmed Account Code button on the telephone and if the system includes Call Accounting System (CAS).
9. Frequently dialed numbers	Identifies useful numbers for the System Speed Dial list.
10. Picks up calls	Identifies need for a Pickup group.
11. View incoming caller information	Identifies which telephone users need call screening capabilities. This service may be part of the local telephone company's services, if available, and must be subscribed to.

Obtaining a Floor Plan

You may want to use a floor plan to make planning more manageable and to ensure that the correct telephone equipment is assigned to each employee. If the customer does not already have a floor plan showing the location of system equipment, you should create one. Use the symbols shown in Figure 1–1 and the following instructions:

1. Use a large sheet of paper and sketch the office layout. The location of office walls and other partitions is important when features are assigned to telephones that must be within hearing range of each other. For example, pickup group members must be able to hear each others' telephones ringing.
2. Indicate the location of each employee's telephone, other locations that will have a telephone (such as a conference room), and the locations of data terminals, PCs, and host computers.
3. Indicate the type of telephone at each location, using an abbreviation that includes the number of programmable buttons. For example, write **MLX-10** at 10-button MLX telephones, **MLX-20L** at 20-button MLX display telephones, **BIS-34** at 34-button analog multiline telephones, and so on.
4. Indicate the type of adjunct at each location. For example, write **FAX**, **ans. mach.** (answering machine), **headset**, or other type of adjunct beneath the symbol.
5. Indicate any additional equipment, such as a Station Message Detail Recording (SMDR) printer, Call Accounting System device, equipment required for off-site telephones, and so on.
6. Indicate the locations where AC power is available and/or required, for example, for a Multi-Function Module (MFM), a console with two Direct Station Selectors (DSSs), or an Integrated Services Digital Network (ISDN) terminal adapter (such as the ExpressRoute 1000 or ISDN 7500B Data Module).

The floor plan does not need to be elaborate or to scale. Keep the floor plan. Refer to it during planning and complete it (by filling in extension numbers) when you get to "Numbering the System" in Chapter 2.

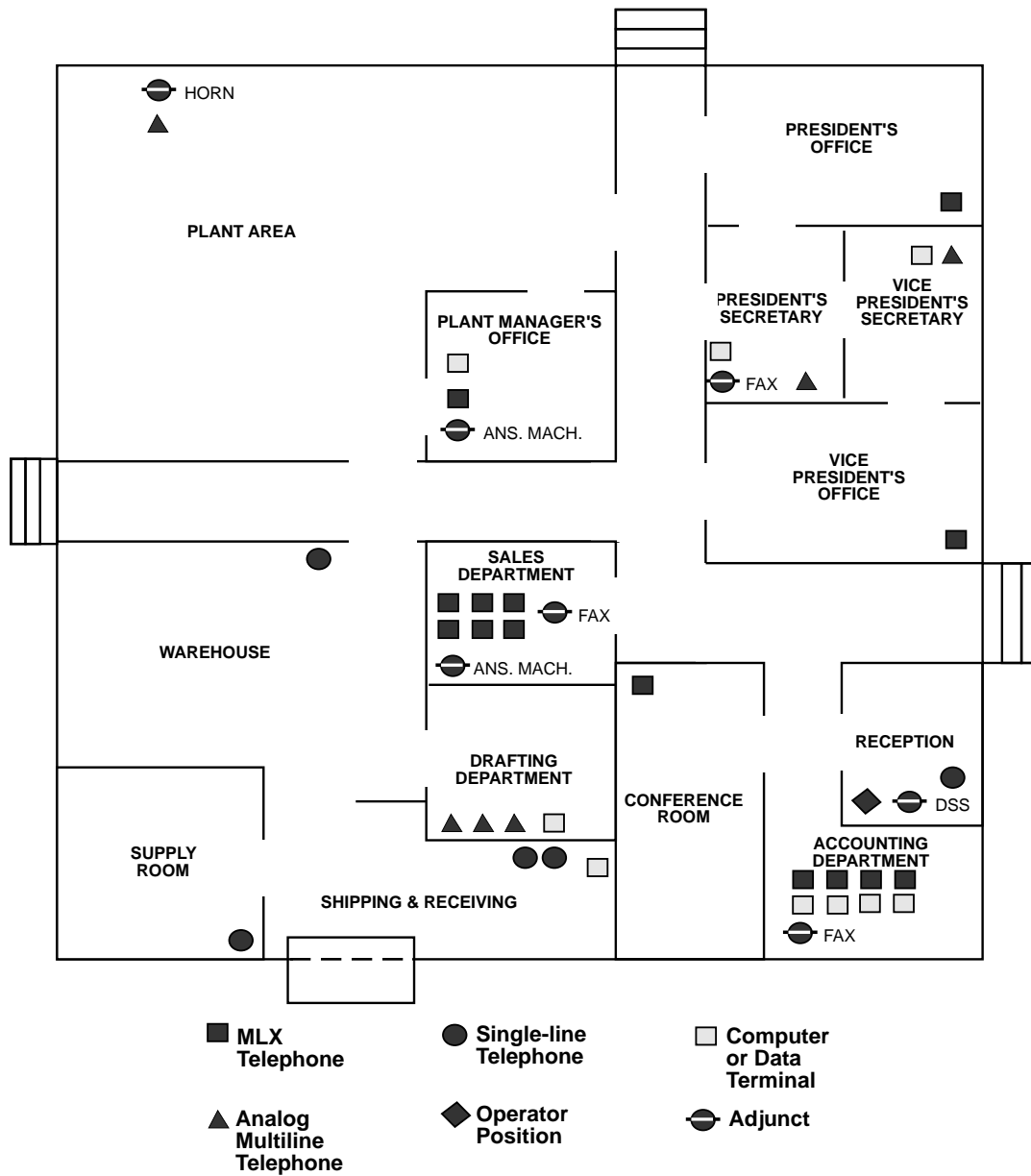

Figure 1-1. Sample Floor Plan

Control Unit Configuration

2

Contents

Planning Module Placement	2-1
■ Capacity for Lines/Trunks	2-2
■ Capacity for Extensions	2-2
■ Control Unit Diagram—Module Placement	2-4
Recording System Operating Conditions	2-7
■ Programming Equipment	2-7
■ System Mode	2-8
■ Language Selection	2-9
■ Automatic Maintenance Busy	2-10
■ Set System Date	2-10
■ Backup	2-11
■ System Consoles	2-11
■ Second Dial Tone Timer	2-12
■ Applications	2-12
Numbering the System	2-13
■ Identifying Extension Jacks	2-14
Module Types and Extension Jack Types	2-14
Touch-Tone Receivers (TTRs)	2-16
Jack for Primary Operator Position	2-18
Jacks for Additional Operator Positions	2-19
Extension Jack Pairs for Analog Telephones	2-21
Jacks for MLX Telephones	2-22
Jacks for Analog Multiline Telephones	2-24
Jacks for Tip/Ring Equipment and Applications	2-25
Labels	2-27
■ System Renumbering	2-27
■ Updating Planning Information	2-31

After you have completed the preplanning tasks described in Chapter 1, "Before You Begin," you can plan the control unit configuration. Planning the control unit configuration consists of the following tasks:

1. **Planning Module Placement.** Calculate the system's line/trunk and extension capacity according to the number of module types; then map out the placement of the modules on the Control Unit Diagram.
2. **Recording System Operating Conditions.** Note the system's type of programming equipment, mode and language choice, and whether the Automatic Maintenance Busy feature is to be enabled or disabled.
3. **Numbering the System.** Decide the order in which to connect the telephones and other equipment to the control unit based on the customer's needs and applications. Determine whether the system-assigned extension numbers are appropriate for the customer's business or if they need to be renumbered.

This chapter contains instructions for completing each of these tasks.

Planning Module Placement

In addition to the processor module and power supply module, the system supports several types of line/trunk and extension modules. Deciding how to place the modules in the carriers consists of the following tasks:

1. Calculating the system's line/trunk capacity according to module types
2. Calculating the system's extension capacity according to module types
3. Mapping out module placement on the Control Unit Diagram according to specific guidelines

This section contains instructions for each of these tasks.

For information about calculating unit load requirements, see Appendix F, "Unit Load Calculation."

For detailed information about modules and their specifications (including line/trunk and extension capacity), see the descriptions of hardware components in the *Equipment and Operations Reference*.

Forms Needed

- Equipment List (if available)
- Form 1, System Planning

Capacity for Lines/Trunks

Line/trunk capacity is the number of lines/trunks that can be connected to the control unit. This section contains instructions for calculating the system's capacity for lines/trunks according to the system's module types.

Planning Form Instructions

1. In the table under the Line/Trunk Capacity section of Form 1, System Planning, fill in the number of each type of line/trunk module on the appropriate line of the Number of Modules column.
2. Add the column and record the result at the bottom of the column on the System Totals line.
3. For each module type noted, multiply the value in the Number of Modules column by the value in the Trunks Supported by Module column; write the results on the appropriate row under Total Trunks by Module Type.
4. Add the column and record the total line/trunk capacity of the system at the bottom of the column, on the System Totals line.

Capacity for Extensions

Extension capacity is the number of extensions that can be connected to the control unit. In most cases, the number of physical jacks on the modules indicates capacity. Most modules have one or two power-failure transfer (PFT) jacks used to connect a single-line telephone in case of a power failure and not counted in system capacity.

One extension number is automatically assigned to each extension jack, whether or not equipment is connected to it, except for the 008 MLX, 408 GS/LS-MLX, and 008 OPT modules:

- **008 MLX and 408 GS/LS-MLX Modules.** Two extension numbers are assigned to each physical jack: the first for an MLX telephone and the second for any equipment connected to the telephone through an MFM, ISDN terminal adapter (such as the ExpressRoute 1000 or 7500B data module), or any 2B data desktop video endpoint.

NOTE:

When using the 008 MLX or 408 GS/LS-MLX module for data or video, you must use Version 28 of the module.

- **008 OPT Module.** The system recognizes this module as an 012 module. Therefore, even though the OPT module has only 8 physical jacks, it uses 12 ports of capacity. An extension number is assigned to each of the 8 physical jacks.

This section contains instructions for calculating the system's extension capacity according to the number of certain module types.

Planning Form Instructions

1. In the table under the Extension Capacity section of Form 1, fill in the number of each type of extension module on the appropriate line of the Number of Modules column.
2. Add the column and record the result at the bottom of the column (System Totals line).
3. For each module, multiply the value in the Number of Modules column by the value in the Physical Jacks per Module column and record the results on the appropriate line in the Physical Jacks by Module Type column.
4. Add the column and record the results at the bottom of the column (System Totals).
5. To determine the number of extensions assigned for each module type, multiply the value in the Physical Jacks by Module Type column by the value in the Extensions Assigned column and write the results in the appropriate row in the Total Extensions Assigned column.

NOTE:

Since the system assigns an additional four extensions to each 008 OPT module, you must first calculate the Extensions Assigned by multiplying the number of 008 OPT modules (noted in the Number of Modules column) by 4 and then add this subtotal to the number noted in the Physical Jacks by Module Type column.

6. Add the column and record the result at the bottom of the column (System Totals).

Control Unit Diagram—Module Placement

This section describes how to use the Control Unit Diagram on Form 1 (page 2) to map placement of the modules according to certain guidelines. Figure 2–1 provides an example of a Control Unit Diagram for a system with 32 lines/trunks and 52 extensions. In addition, this section describes how to identify each jack on each module with respect to type (line/trunk or extension) and its associated logical ID. Each physical jack on the control unit is numbered sequentially from bottom to top and left to right with logical IDs as follows:

- Extension jacks are numbered from 1 to 200.
- Line/trunk jacks are numbered from 1 to 80.

This sequence of logical IDs is the basis for connecting components to the control unit, as well as for the assignment of extension numbers and line/trunk numbers.

Planning Form Instructions

NOTE:

The Unit Load blocks above the diagram are reserved for equipment changes or maintenance. A technician computes these values manually.

1. On the Control Unit Diagram of Form 1 (page 2), record the type of module to be installed in each slot by writing the module name (for example, **008 MLX**) on the slanted lines at the top of each slot. Use the following guidelines:
 - Indicate the power supply module in the far left slot of each carrier.
 - Indicate the processor module in Slot 00 of the basic carrier.
 - Indicate line/trunk and extension modules in any order in Slots 01 through 17, with the following conditions:
 - Group the modules in each carrier from left to right with no empty slots between modules. (The system does not recognize modules in slots that follow an empty slot; slots to the right of the last module can be left empty.)
 - (Hybrid/PBX mode only) If the system includes a Queued Call Console (QCC), the first line/trunk and/or extension module must be a 408 GS/LS-MLX or 008 MLX module.
 - (All modes) Current 012, 008 OPT, and 016 modules have built-in ring generators and are compatible with earlier releases. The 012 module [517G13 (28)] has a ring equivalency number (REN) of 2.2 and rings only 4 ports at a time, although 8 jacks can be used for applications. The 016 module (517A34) has a REN of ≥ 4 , can ring 16 ports at a time, and has no restriction on the number of jacks that can be used for applications.

- Group all 800 DID, 100D, 800 NI-BRI, and 400EM modules together according to type; this may save time in system programming.

NOTE:

Due to limitations in the 391A, 391A1, and 391A2 power supplies, the number of 800 NI-BRI modules plus 100D modules in a single carrier cannot exceed three. If you have more than three modules, you must install the additional modules in an expansion carrier. This restriction does not apply to the 391A3 power supply.

2. For each line/trunk and extension jack on each module, write the type of jack (**X** = extension; and **L/T** = line/trunk) and the associated logical ID, keeping in mind the following:
 - Each 100D module is assigned 24 logical IDs, even though the module has only 1 physical trunk jack.
 - Each 800 NI-BRI module is assigned 2 logical IDs per physical trunk jack for a total of 16 logical IDs.
 - The 008 OPT module is assigned 12 logical IDs, even though the module has only 8 physical extension jacks.
 - Power-failure transfer (PFT) jacks are not assigned logical IDs.

NOTES:

1. If the system will have 1 or more PFT telephones (maximum: 20), indicate on the Control Unit Diagram the modules that will have PFT telephones connected to their PFT jacks; write **PFT** in the modules. A PFT telephone can be connected to a PFT jack on a 400, 400 GS/LS/TTR, 800, 800 GS/LS, 800 GS/LS-ID, 408, 408 GS/LS, or 408 GS/LS-MLX module. Touch-tone PFT telephones must be connected to jacks with touch-tone lines/trunks.
2. You need a ground-start button on a PFT telephone connected to a ground-start trunk.

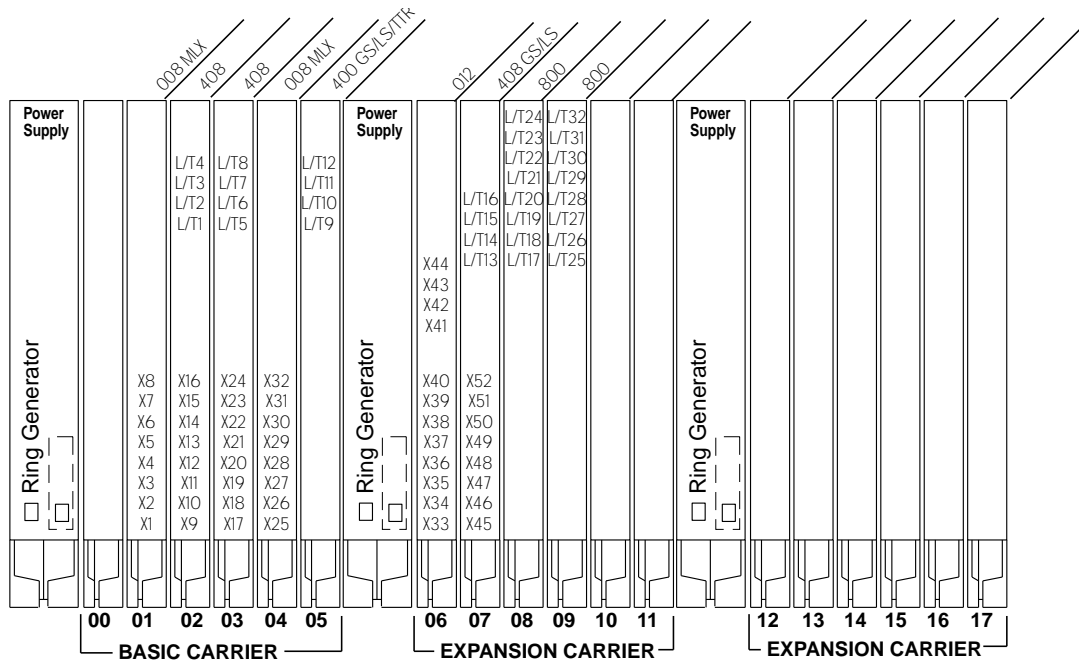

Figure 2-1. Sample Control Unit Diagram

Recording System Operating Conditions

This section contains instructions for recording the following system operating conditions:

- Programming equipment that will be used and its extension jack assignment
- Mode of operation
- Language choice
- Enable and disable Automatic Maintenance Busy
- A reminder to set the system date
- Backup schedule
- Identifying system console extensions
- Second Dial Tone Timer
- Identifying system applications

Forms Needed

Form 1, System Planning

Programming Equipment

Two types of equipment can be used for system programming:

- An MLX-20L telephone identified as a system programming console. The telephone is connected to the first (lowest) extension jack (which is factory-set for system programming) on the first MLX module.
- A personal computer (PC) with System Programming and Maintenance (SPM) software. The PC connects to the lowest jack on the processor module.

Planning Form Instructions

1. Under the Programming Equipment heading in the System Operating Conditions section on Form 1 (page 2), do *one* of the following:
 - If the system will use a system programming console, check System Programming Console. Proceed to Step 2.
 - If the system will use a PC with SPM software, check the PC with SPM Software box and skip to the next section, "System Mode."

NOTES:

1. In conjunction with the MLX-20L telephone and the PC, a Personal Computer Memory Card International Association (PCMCIA) card is required for Release 4.0 of the communications system. Check the box labeled PCMCIA Memory Card.
2. In addition to being factory-set for system programming, the first (lowest) extension jack on the first MLX module is also factory-set as the primary operator position. Since the primary operator position cannot be reassigned to another extension jack, you may want to change the system programming assignment to ensure that future programming sessions do not interfere with the operator's work.
2. To change the factory-set system programming jack, write in the new logical ID using the information from the Control Unit Diagram.

If you want the system programming jack to be different from that of system operators, change the programming assignment to any one of extension jacks 2 through 5 on the first MLX module in the control unit (the lowest jack on the module is extension jack 1). You fill in the extension number of the jack later.

System Mode

The mode of operation determines how outside lines/trunks are provided to users, the types of operator consoles allowed, the features available, and how they work. Each system is registered with the Federal Communications Commission (FCC) to operate as a Private Branch Exchange (PBX), Hybrid, or Key system (factory setting). However, you can program the system to operate in any of the three modes: Hybrid/PBX, Key, or Behind Switch.

Planning Form Instructions

Under the System Mode heading in the System Operating Conditions section of Form 1 (page 2), check *one* of the following:

- If the system will operate in Key mode, check Key. (This is the factory setting.) If need be, this mode can be changed to Hybrid/PBX mode at another time.
- If the system will operate in Hybrid/PBX mode, check Hybrid/PBX.
- If the system will be connected behind a larger system or a Centrex system, check Behind Switch and record the host's dial codes for the Transfer, Conference, and Drop features so users can access these features on the larger system.
- If you check Permanent Key, the switch in the back of the processor module must be placed in the Permanent Key position. The switch cannot be changed without changing the FCC registration of the system.

Language Selection

In Release 1.1 and later versions of the system, language-specific operation is available in English, French, and Spanish. The language selection affects prompts and displays on user telephones, SPM system programming displays, SMDR records, and printed reports.

This feature works as follows:

- The MLX-10D, MLX-20L, and MLX-28D display telephones, and the MLX-10 nondisplay telephones are available in three separate versions, each with the factory-set buttons in the language of choice.
- The system can be programmed to operate in one of the languages, but an individual with an MLX telephone can override the system language by selecting any one of the three languages for his or her own telephone.

This section describes how to record the selected language for the system and, if desired, to set a different language for SMDR and printers.

NOTE:

If you plan to set a different language for an individual telephone, record the language selection on Form 6b as described in Chapter 4, "Features."

Planning Form Instructions:

Under the Language Selection heading in the System Operating Conditions section of Form 1 (page 2):

1. To select a systemwide language, check *one* of the following: English (the factory setting), French, or Spanish.
2. To set a different language for SMDR, check *one* of the following: English (the factory setting), French, or Spanish.
3. To set a different language for printed reports, check *one* of the following: English (the factory setting), French, or Spanish.

Automatic Maintenance Busy

The factory setting for Automatic Maintenance Busy is Disable, which means that faulty lines/trunks are *not* automatically put in a maintenance-busy state. In Key and Behind Switch modes, Automatic Maintenance Busy usually remains disabled. If you plan to group lines/trunks into pools in Hybrid/PBX mode, enable Automatic Maintenance Busy to provide optimal system performance.

For a detailed description of this feature (including considerations and feature interactions), see the *Feature Reference*.

Planning Form Instructions

Under the Automatic Maintenance Busy heading in the System Operating Conditions section of Form 1, page 2, do *one* of the following:

- To keep the factory setting (no maintenance-busy state), check Disable.
- To enable Automatic Maintenance Busy, check Enable.

Set System Date

The system date is the month, day, and year, shown on display telephones and SMDR reports (for information on SMDR, see “System Features” in Chapter 4). Error reports used by authorized technicians for maintenance also show the system date and time.

These sections on the planning form remind you to set the system date when you perform the initial programming for the system.

Planning Form Instructions

Check Yes under the Set System Date heading on Form 1 as a reminder to set the current date.

Backup

Backup makes a copy of the customized system data on a translation memory card. A backup is made after each system upgrade, service technician visit, or major system reconfiguration.

NOTE:

If Automatic Backup is used, the customer must ensure that a valid PCMCIA Translation card is in the processor slot at the time of the backup. Otherwise, the Automatic Backup feature will be canceled and the customer will not be able to reset it.

Planning Form Instructions

Check Automatic if weekly or daily backup procedures are planned. Record the day and time in the blank space for weekly backups or the time of day for daily backups.

Check Manual if you plan manual backup procedures.

System Consoles

To make programming easier, use this section to summarize information about the consoles in the system.

Planning Form Instructions

Under the System Consoles heading, check the type(s) of consoles:

- For Queued Call Consoles, check the QCC(s) box and enter the extension numbers (if known).
- For Direct-Line Consoles, check the DLC(s) box and enter the extension numbers (if known).

Second Dial Tone Timer

In some instances, after dialing a star code the CO responds with a second dial tone as a prompt to enter additional digits. Once a star code is accepted by the communications system, the Second Dial Tone Timer is activated and set to the programmed value. If dialing is attempted before the Second Dial Tone Timer expires, the call is treated as though it had violated calling restrictions and is not completed.



SECURITY ALERT:

If the Second Dial Tone Timer is set to 0 ms and a caller begins dialing additional digits before the second dial tone, system restrictions may be bypassed and a restricted call may be routed. Careful administration of the Second Dial Tone Timer prevents the caller from bypassing call restrictions in this manner.

Marked System Speed Dial entries (entries that do not display) are not affected by the Second Dial Tone Timer setting. If the Central Office does not immediately supply dial tone when a star code is entered and a Marked System Speed Dial entry uses star codes, then the appropriate number of pauses (each 1.5 seconds) must be programmed in the entry following each star code.

Planning Form Instructions

Under the Second Dial Tone Timer heading, enter the desired value. Valid entries are 0 – 5000 ms in increments of 200 ms. The system default is 0.

Applications

Several call-handling and management applications can be used with the system, including voice mail and messaging; call accounting and reporting; and call management, distribution, and reporting. This section contains instructions for noting those applications that will be used with this system.



CAUTION:

General information about these applications is contained in the Feature Reference. However, to ensure proper service, you must review the documentation provided with the application itself.

Planning Form Instructions

On Form 1 (pages 3 and 4):

1. Check the name of each application that will be connected to the system.
2. For each application name you check, you may want to include pertinent information in the Notes section. For example, you can note the version of the application installed at the customer's site.

Numbering the System

This section describes the assignment of numbers to extensions.

NOTE:

Assigning numbers to calling groups, paging groups, park zones, and remote access is described later in this book.

The process of numbering extensions consists of the following tasks:

- **Identifying Extension Jacks.** Using the placement of modules in the control unit as a guide (see the Control Unit Diagram on Form 1), determine the order in which to connect telephones and other equipment to the control unit. To do this, identify the extension jack types available by module and then match system components (for example, operator positions or telephone types) with the jacks that support them.
- **Renumbering.** If the system-assigned extension numbers are not appropriate for the customer's business, change them. The system offers two automatic numbering plans (2-digit and 3-digit numbers), as well as the option of creating a unique numbering plan with extension numbers of 1 to 4 digits. Each of these three plans allows renumbering of all or selected extensions.
- **Updating Planning Information.** Add information to Form 1 and to the floor plan as appropriate.

This section contains instructions for completing each of these tasks. The *Feature Reference* provides detailed information about system numbering and the three numbering plans.

Forms Needed

- Floor plan
- Equipment List (if available)
- Form 1, System Planning
- Form 2a, System Numbering: Extension Jacks
- Form 2b, System Numbering: Digital Adjuncts

Identifying Extension Jacks

Identifying extension jacks consists of the following tasks:

- Determining which extension jack types are available according to the types of modules in the control unit.
- Matching the telephones and other equipment to the jacks that support them, in the following order:
 - Primary operator position
 - Additional operator positions
 - Extension jack pairs (for analog multiline telephones only with Voice Announce to Busy feature and/or voice and data)
 - MLX telephones
 - Analog multiline telephones
 - Tip/ring equipment and applications

Planning Form Instructions

Before you begin, review the floor plan and Equipment List (if available) to identify the equipment and the number of each kind of connection needed, as well as to obtain other information you need to fill in the forms:

- Number, type(s), and user name and/or location of operator consoles
- Number and user name and/or location of analog multiline telephones that will use the Voice Announce to Busy feature or voice and data.
- Number of non-operator MLX telephones and user names and/or locations
- Number and user name and/or location of analog multiline telephones
- Number and user name and/or location of tip/ring equipment
- Names of optional applications

Module Types and Extension Jack Types

The module type determines the type of extension jack used. For example, the 016 module has 16 basic telephone jacks. Table 2-1 lists the extension jack types and the equipment that can be connected to these jacks.

Table 2-1. Application Ports

Module	Ext. Jack Type	No. of Jacks	Used to Connect
008	Analog	8	Analog multiline telephones
408		8	Call Management System (CMS)
408 GS/LS		8	
008 MLX	Digital	8	MLX telephones with or without PassageWay Direct Connect Solution
408 GS/LS-MLX		8	Desktop video endpoints** Digital data devices, such as an ISDN terminal adapter†**
012	Basic	12	Tip/ring equipment, such as:
016	Telephone	16	Single-line telephones
			Adjuncts, such as answering or fax machines or MERLIN® Identifier
			Optional applications: MERLIN MAIL® Voice Messaging System AUDIX Voice Power™ (IS II or III) Integrated Voice Power Automated Attendant (IS II or III)
008 OPT		8*	Tip/ring equipment in another building or off premises Off-Premises Range Extender

* The system uses 12 logical IDs for an 008 OPT module, even though only 8 will have equipment attached to them. Do not use an 008 OPT module for applications (such as AUDIX Voice Power, MERLIN MAIL, MERLIN Identifier or AT&T Attendant™). Be sure to leave the extra 4 ports blank on Form 2a.

† ISDN terminal adapters include such devices as: ExpressRoute 1000 and 7500B Data Module.

** When using the 008 MLX or 408 GS/LS-MLX module for data or video, you must use Version 28 of the module.

Planning Form Instructions

Refer to the completed Control Unit Diagram (Form 1) and Table 2-1 above to mark the extension jack types on Form 2a:

1. For each extension module noted in the Control Unit Diagram (beginning with Slot 01) write in the type of module in the Mod. Type column of Form 2a and, after the appropriate logical ID (Log. ID) number, draw a line to indicate the end of that module.

For example, if the first module in the control unit is an 008 MLX module that has 8 jacks, write **008 MLX** in the Mod. Type column and draw a line after Logical ID 8.

NOTE:

If your list includes an 008 OPT module, draw a line after the twelfth logical ID, but cross off the last four logical IDs, since these jacks cannot be used to physically connect telephone equipment. The extension numbers of these logical IDs can be used, however, for applications requiring phantom extensions.

2. In the Jack Type column of Form 2a, do *one* of the following to indicate the type of each extension jack next to its logical ID:
 - If the jack is analog, check A.
 - If the jack is digital, check D.
 - If the jack is basic telephone, check B.

You are now ready to match the system telephones and other equipment to these available jacks. After calculating touch-tone receivers as described in the next section, begin matching equipment and jacks with “Jack for Primary Operator Position,” and proceed through the subsequent sections as appropriate for the system.

Touch-Tone Receivers (TTRs)

Use these guidelines for calculating the system requirements for touch-tone receivers for systems both with and without a voice messaging system (VMS).

TTRs for the system are supplied by the modules listed in Table 2–2.

Table 2-2. Modules with Touch-Tone Receivers

Module	Number of TTRs
008 OPT	2
012	2
016	4
400 GS/LS/TTR	4
400	4
800 DID	2
800 GS/LS-ID	2

NOTE:

A VMS *cannot* be directly connected to the 008 OPT module. However, the TTRs supplied by the 008 OPT module can be used by the VMS.

A VMS requires a certain number of TTRs, in addition to any system requirements for TTRs. The number of TTRs required by a VMS depends on the number of ports used by the VMS (see Table 2-3).

Table 2-3. Touch-Tone Receivers Required by Voice Messaging Systems

Number of VMS Ports	Number of TTRs Required
1	1
2	1
3	2
4	2
6	3
8	4
12	6

The number of TTRs required by the system depends on the call volume for all incoming calls on remote access, direct inward dial (DID) trunks, and T1 data channels (planning information about trunks is provided in Chapter 3, "Lines/Trunks"), outgoing calls on single-line telephones, and tie lines. In addition, if account codes are used, additional TTRs are required for the single-line telephones. Table 2-4 gives estimates for the total number of TTRs required in the system based on call volume and whether the system has a VMS and uses account codes. The call volume in this table includes all calls originated from single-line telephones, calls on tie lines, incoming remote access and direct inward dial (DID) calls, and calls routed to the VMS.

Table 2-4. System Requirements for Touch-Tone Receivers

Calls/Hour	No Account Codes	Account Codes Used
110	2	4
180	4	4
350	4	4
420	6	8
610	6	6
710	8	8

To calculate the total number of TTRs that are required by the system, do the following:

1. If the system has a VMS, use Table 2–3 to find the number of TTRs required by the system to support the VMS. If the system does not have a VMS, then proceed to Step 2.
2. Estimate the hourly call volume for all calls originating from single-line telephones, incoming calls on Remote Access, DID lines, T1 data lines, and calls on tie lines.
3. Use Table 2–4 to find the system requirements for TTRs based on the hourly call volume estimated in Step 2.
4. If the system has a VMS, add the TTRs required for the VMS (Step 1) to the system requirements for TTRs (Step 3). This is the total number of TTRs required for the system.

Jack for Primary Operator Position

The factory setting for the primary operator position is the lowest extension jack on the first MLX or analog multiline telephone module. You cannot change the factory setting for the primary operator position.

The primary operator position uses two types of operator consoles:

- **Direct-Line Console (DLC)**. Can be assigned to either a digital or analog extension jack.
- **Queued Call Console (QCC)**. Can be assigned only to a digital extension jack, and the MLX-20L is the only telephone that can be used as a QCC.

If the system includes QCCs, the primary operator position must be a QCC.

Planning Form Instructions

Mark jack assignments on Form 2a:

1. Do *one* of the following:
 - If the system uses a system programming console, proceed to Step 2.
 - If the system does not use a system programming console, skip to Step 5.
2. Obtain the logical ID of the extension jack for the system programming console by referring to the System Operating Conditions heading, Form 1 (page 2).
3. Identify the logical ID for the system programming console by writing **SPC** beside the appropriate logical ID in the Log. ID column of Form 2a.

4. Write either the name of the person who will program the system or the location of the system programming console in the Person, Location, or Function column. Then proceed to Step 5.
5. Do *one* of the following:
 - To indicate the primary QCC operator position for a system with one or more QCCs, proceed to Step 6.
 - To indicate the primary DLC operator position for a system with one or more DLCs, skip to Step 7.
6. To indicate the primary QCC operator position:
 - a. Locate the first extension jack showing a D (digital) jack type and write **QCC** beside the preprinted logical ID number.
 - b. Write the name or location of the primary QCC operator in the Person, Location, or Function column.
 - c. On Form 1 (page 2), write the extension of the QCC under System Consoles.
7. To indicate the primary DLC operator position:
 - a. Locate the first extension jack showing a jack type of D (digital) or A (analog) and write **DLC** beside the preprinted logical ID number.
 - b. Write the name or location of the primary DLC operator in the Person, Location, or Function column.
 - c. On Form 1 (page 2), write the extension of the DLC under System Consoles.

Proceed to the next section, "Jacks for Additional Operator Positions."

Jacks for Additional Operator Positions

Use these instructions only if the system has more than one operator position. Otherwise, skip to the next section, "Extension Jack Pairs for Analog Telephones."

The maximum number of operator positions is shown in Table 2-5.

Table 2-5. Maximum Number of Operator Positions

Position	Telephone	Maximum
QCC	MLX-20L	4
DLC	MLX-20L	8
	MLX-28D	
DLC	Analog multiline telephones	8

Any combination of operator positions can be assigned as long as no more than four are QCCs and the total combined number is no more than eight. For example, a system can have a combination that consists of four QCCs, two MLX DLCs, and two analog DLCs. The Call Management System (CMS) equipment connects to analog extension jacks assigned as DLC positions. You must assign two DLC positions for each CMS (maximum of two) connected to the system on analog multiline modules.

Planning Form Instructions

NOTE:

For each CMS connected to the system, you must assign two DLC positions. These two DLCs do *not* need to have the default extension numbers but do need to be on the same module.

1. On the Control Unit Diagram on Form 1, determine which extension jacks can be used as operator positions by circling the first and fifth extension jacks on digital or analog modules until you have reached the maximum number of eight positions.
2. On Form 2a, mark the extension jacks to be used as additional operator positions.
3. Do *one* of the following:
 - If the system has additional QCCs, proceed to Step 4.
 - If the system has additional DLCs, skip to Step 5.
4. For each additional QCC:
 - a. Write **QCC** next to the preprinted logical ID for each additional QCC position. Be sure to assign QCCs to only the first and fifth extension jacks on each digital module.
 - b. Write the name or location of each additional QCC operator in the Person, Location, or Function column.
 - c. On Form 1 (page 2), write the extension number of each additional QCC in the System Consoles box.
5. For each additional DLC:
 - a. Write **DLC** next to the preprinted logical ID for each additional DLC position, including DLC positions used for calling group supervisors and for the optional CMSs. Be sure to assign DLCs to only the first and fifth extension jacks on each digital or analog module.
 - b. Write the name or location of each additional DLC operator in the Person, Location, or Function column.
 - c. On Form 1 (page 2), write the extension number of each additional DLC in the System Consoles box.

6. If the system includes any Call Management Systems, write **CMS** in the Person, Location, or Function column next to the logical ID for the two DLC positions assigned for each CMS.

Proceed to the next section, "Extension Jack Pairs for Analog Telephones."

Extension Jack Pairs for Analog Telephones

Use these instructions only if the system has analog multiline telephones. Otherwise, skip to the next section, "Jacks for MLX Telephones."

MLX telephones can use the Voice Announce to Busy feature or simultaneous voice and data without requiring a second extension jack.

Analog multiline telephones require an additional extension jack to use Voice Announce to Busy or voice and data. The jacks must be an odd-numbered analog extension jack and the next higher (even-numbered) analog extension jack. The system assigns individual extension numbers to each of the jacks. The extension number associated with the first (odd-numbered) extension jack in the pair is the telephone's extension number. Calls cannot be placed to the extension number associated with the even-numbered extension jack. (For information about renumbering jacks, see "System Renumbering" later in this chapter.)

You can assign Voice Announce to Busy or voice and data to any of the analog multiline telephones in the system, but you cannot assign both to the same telephone.

Planning Form Instructions

On Form 2a, mark the pairs of jacks for analog multiline telephones that have Voice Announce to Busy or voice and data:

1. In the Log. ID column, draw a box around the pair of extension jack numbers that you plan to assign to each analog multiline extension with either feature.
2. In the Person, Location, or Function column, next to the first (odd-numbered logical ID) number of each boxed pair, identify the extension by person or location.
3. In the Person, Location, or Function column, next to the second (even-numbered logical ID) number of each boxed pair, do *one* of the following:
 - For the Voice Announce to Busy feature, write **voice/voice**.
 - For voice and data, write **voice/data**.

Proceed to the next section, "Jacks for MLX Telephones."

Jacks for MLX Telephones

Use these instructions only if the system has non-operator MLX telephones or digital data/video stations (such as a videoconferencing station) to assign to digital extension jacks on 008 MLX and 408 GS/LS-MLX modules. Otherwise, skip to the next section, "Jacks for Analog Multiline Telephones." To plan connections for digital data equipment, see Chapter 5, "Data Communications."

NOTE:

When using the 008 MLX or 408 GS/LS-MLX module for data or video, you must use Version 28 of the module.

The system assigns two extensions, although only one logical ID is assigned to each digital extension jack. For MLX telephones, one extension number is automatically assigned to the MLX telephone physically connected to the digital extension jack. The second extension number is reserved for an adjunct, such as a modem, that can be connected to the MLX telephone through a Multi-Function Module (MFM), or for an ISDN terminal adapter (such as the ExpressRoute 1000 or the ISDN 7500B Data Module) used to connect a data terminal. For information about renumbering jacks, see "System Renumbering," later in this chapter.

The system automatically assigns both extension numbers whether or not the extension includes an MFM or ISDN terminal adapter. Calls can be placed to both extension numbers independently.

The MFM can operate as an interface for either a Supplemental Alert Adapter or a tip/ring device. The Supplemental Alert Adapter (SAA) setting on the MFM is used when the MFM connects an external alert such as a bell or horn. The tip/ring (T/R) setting is used when the MFM connects a tip/ring device such as an answering machine or modem.

NOTE:

The system capacity for extensions is decreased by two whenever an MLX-20L telephone is used.

In Behind Switch mode, the system automatically assigns two prime lines to each port on an MLX module—one for the MLX telephone and one for the device connected to the MFM. If an MFM is not connected to an MLX telephone or the MLX port is not used, the prime line for the MFM can be removed. The prime line can then be assigned to another user.

When PRI, NI-1 BRI, or T1 Switched 56 lines/trunks are assigned to an MLX jack, digital data/video stations may use two B-channels simultaneously (2B Data) to place or receive high-speed data/video calls. Optionally, some video stations may be set up in a *Passive Bus* configuration. In this configuration, one MLX jack serves both the video system and a standard MLX telephone that is connected to the video system rather than directly to the MERLIN LEGEND. For more information on planning for video applications, see Chapter 5, "Data Communications."

Planning Form Instructions

Use the floor plan and Equipment List (if available) to verify that you have located any video stations and all remaining MLX telephones and adjuncts connected to them.

1. On Form 2a, mark the extension jack assignments for the video stations and the remaining MLX telephones:
 - a. In the Jack Type column, make sure D is checked next to the logical ID for each digital extension jack.
 - b. In the Person, Location, or Function column, identify each video station or MLX telephone by the user's name, location, or function.
 2. Using the information from Form 2a, mark the digital extension adjuncts and video stations on Form 2b, System Numbering: Digital Adjuncts:
 - a. Do *one* of the following:
 - If the jack does not have an adjunct connected, write **None** in the Adjuncts column and skip to Step 3.
 - If an adjunct is connected to the MLX telephone, proceed to Step b.
 - b. If an adjunct is connected to the MLX telephone, enter the type of adjunct (such as **MFM-SAA**, **MFM-T/R**, **ER1000**, or **7500B**) in the Adjuncts column.
 - c. If a digital data or video station will be connected to the jack, and the equipment supports 2B Data (such as a videoconferencing system using a BRI interface or a v.35 interface and an ISDN terminal adapter that supports 2B Data), check the box in the 2B column.
- NOTE:**
Do not connect equipment that does not support 2B Data (such as G4 FAX, or a videoconferencing system using a v.35 interface and an ISDN terminal adapter that does not support 2B Data) to an MLX jack configured as a 2B Data port.
- d. If an MLX telephone will be connected to a desktop video system in a passive bus configuration, check the box in the Pass. Bus column. Also make an entry on Form 4d, MLX Telephone, to indicate that the MLX telephone is in a passive bus configuration and note the type of endpoint to which the MLX telephone is connected.
 - e. If a digital data or video system is connected to the jack, enter the extension number in the MLX Telephone Ext. No. column.
3. In the last column, identify the type of equipment connected to the jack or the ISDN terminal adapter connected to the jack. Also, record the person, location, or function if desired.

Proceed to the next section, "Jacks for Analog Multiline Telephones."

Jacks for Analog Multiline Telephones

Use these instructions only if the system includes 408, 408 GS/LS or 008 modules. Otherwise, skip to the next section, "Jacks for Tip/Ring Equipment and Applications."

Certain features should be used differently when a GPA (General-Purpose Adapter) is connected to an analog multiline telephone and configured using the "Automatic" setting. These configurations include:

- GPA connected to an answering machine and an analog multiline telephone with Auto Answer All button programmed.
- GPA connected to an analog multiline telephone programmed for voice and data.

NOTE:

An MLX telephone with an MFM installed is preferred for these applications.

When these configurations are used, lift the handset before activating features that automatically turn on the speakerphone. Examples of features that automatically turn on the speakerphone are Authorization Codes, Auto Dial, Last Number Dial, and Saved Number Dial.

Assign analog extension jacks for all remaining non-operator analog multiline telephones in the system.

Planning Form Instructions

On Form 2a, mark the extension assignments for the remaining analog multiline telephones:

1. In the Jack Type column, make sure A is checked next to the logical ID for each analog extension jack.
2. In the Person, Location, or Function column, identify each analog multiline telephone by the user's name, location, or function.

Jacks for Tip/Ring Equipment and Applications

Use these instructions only if the system includes 012, 016, or 008 OPT modules. Otherwise, skip to the next section, "Labels."

Assign the basic telephone jacks on the 012, 016, or 008 OPT modules to any tip/ring equipment such as single-line telephones, fax machines, or modems. The hardware design of the 008 OPT module includes an interface for off-premises telephones, which includes increased gain levels and protection.

If assigning basic telephone jacks on an 016 module, the Ringing Frequency may be set to either 20-Hz (Type A) or 25-Hz (Type E). The Ringing Frequency is administrable on each 016 module and affects all ports on that 016 module.

Several optional applications, if used with the system, require basic jacks on a 012 or 016 module: MERLIN MAIL VMS, AT&T Attendant, AUDIX Voice Power-Integrated Solution II (IS II) or III (IS III), and Integrated Voice Power Automated Attendant-IS II or IS III. Do not use the 008 OPT module for these applications.

NOTE:

If the system has AUDIX Voice Power, the Integrated Administration feature provides a single interface through Integrated Solution III (IS III) for programming entries common to the system and to the AUDIX Voice Power system. These common entries are noted on the planning forms, and instructions for planning the system in conjunction with planning for the AUDIX Voice Power system are included in the procedures throughout this book. For more information about this and other applications, see the *Feature Reference*.

The system can accept up to eight application ports (extension jacks for applications) using the 012 module [517G13(28)]. All 16 ports on the 016 module (517A34) may be used for applications.

Table 2–6 shows, by application, the number of ports used, the number of TTRs required, and the number of additional single-line telephones that can be added to the modules. Use this table as a guideline.

Table 2-6. Application Ports

Application	Ports	TTRs	Telephones
MERLIN MAIL	2	1	5 + 1 for the modem
	4	2	3 + 1 for the modem
AT&T Attendant	1	1	6 + 1 for programming
	2	1	5 + 1 for programming
	3	2	4 + 1 for programming
	4	2	3 + 1 for programming
AUDIX Voice Power	2	1	6
	4	2	4
	6	3	2
	8	4	0

NOTES:

1. Older versions of the 012 module, (apparatus codes 517C13–517F13) if one or more applications are used, only four tip/ring (T/R) devices may be assigned to the module where the application is assigned, regardless of how many jacks are open.
2. The applications discussed here do not work properly with 012 modules manufactured for older MERLIN® II systems. These applications must be connected to 012 modules with the code 517C13 or 517D13 (or higher) labeled on the top of the module. Modules with the code 517A13 or 517B13 can be used to connect single-line telephones only. They do not provide the disconnect signal required by answering machines and applications. Do not use the 008 OPT module for applications such as AUDIX Voice Power, MERLIN MAIL, or AT&T Attendant.

Planning Form Instructions

On Form 2a, mark the extension jack assignments on the 012, 016, and 008 OPT modules:

1. In the Jack Type column, make sure B is checked next to the logical ID for each basic telephone jack.
2. In the Person, Location, or Function column, identify each T/R device by the user's name or location and by type, such as single-line telephone, fax, or modem.
3. If the system includes optional applications, indicate the application on the appropriate line in the Voice Mail column:
 - To indicate MERLIN MAIL voice messaging system, write **Mail**.
 - To indicate AT&T Attendant, write **AT&T A**.
 - To indicate AUDIX Voice Power IS II or IS III, write **AVP**.

- To indicate Integrated Voice Power Automated Attendant-IS II, write **IVP-AA**.
 - To indicate no voice messaging service, write **None**.
4. If the system has AUDIX Voice Power, also write **port** in the Voice Mail column for any logical IDs that are being used for fax ports.
 5. For each 016 module, if applicable, indicate the Ringing Frequency for that 016 module. Enter **20-Hz** or **25-Hz** in the Ring Freq. column for all ports on the 016 module. When configuring a system in the United States or Canada, generally the 20-Hz setting is applicable. The factory setting is 20-Hz.

Proceed to the next section, "Labels."

Labels

This section contains instructions to associate alphanumeric labels with extension numbers so that both the name of the caller and the extension number appear on display telephones.

Planning Form Instructions

On the appropriate line in the Label column on Form 2a, write the label (maximum: 7 characters) to be displayed for each telephone.

Proceed to the next section, "System Renumbering."

System Renumbering

The selection of a numbering plan depends on the customer's needs. Each of the system's three numbering plans allows you to renumber all or selected extensions. If you do not need to renumber extensions, skip to the last section of this chapter, "Updating Planning Information."

Before the system is renumbered, the AUDIX Voice Power channel assignments should be deleted (through AUDIX Voice Power) for the extensions being renumbered. When the renumbering for the system is complete, AUDIX Voice Power channels for the renumbered extensions should be added.

Figures 2–2 through 2–4 list the extension numbers according to the three numbering plans: 2-digit, 3-digit, and Set Up Space. The numbers are arranged in blocks according to the first digit. The type of equipment or feature they are assigned is shown in the block. The shaded areas of the table indicate extension numbers automatically assigned by the system. The unshaded areas indicate the extension numbers available for reassignment. Use the appropriate plan-specific instructions that follow to mark Forms 2a and 2b with extension number assignments.

For detailed information about the numbering plans (including considerations, constraints, and feature interactions that may affect selection), see the *Feature Reference*.

NOTE:

If the system includes Call Management System (CMS), it assigns extension numbers to agent splits. The CMS agent extension numbers must be two digits. Therefore, use the 2-digit numbering plan for CMS. For more information, see the CMS documentation.

0	Operator Console 0****				
1	Stations 10 — 19				
2	Stations 20 — 29				
3	Stations 30 — 39				
4	Stations 40 — 49				
5	Stations 50 — 59				
6	Stations 60 — 66	Extra Stations 6700 — 6842	6843 — 6849***	Extra Adjuncts 6850 — 6992	6993 — 6999***
7	Main Pool 70	MFMs / TAs (MLX Adjuncts) 710 — 766	767 — 769***	Calling Group 770 — 791, 7920 — 7929	Page 793 — 799
8	800*	Trunks 801 — 880	Park 881 — 888	889**	Pools 890 — 899
9	ARS Access (Hybrid / PBX Mode) / Idle Line Access 9****				

* Listed Directory Number (QCC Queue)

** Remote Access

*** Unused in the default. Available for renumbering.

**** System default. Can be changed.

Figure 2–2. Extension Numbers for 2-Digit Numbering Plan

0	Operator Console 0****			
1	Stations 100 — 199			
2	Stations 200 — 299			
3	MFMs / TAs 300 — 399			
4	MFMs / TAs 400 — 499			
5	500 — 599***			
6	600 — 699***			
7	Main Pool 70		Calling Group 770 — 791, 7920 — 7929	Page 793 — 799
8	800*	Trunks 801 — 880	Park 881 — 888	889** Pools 890 — 899
9	ARS Access (Hybrid / PBX Mode) / Idle Line Access g****			

- * Listed Directory Number (QCC Queue)
- ** Remote Access
- *** Unused in the default. Available for renumbering.
- **** System default. Can be changed.

Figure 2-3. Extension Numbers for 3-Digit Numbering Plan

0	Operator Console 0***					
1	100 — 199					
2	200 — 299					
3	300 — 399					
4	400 — 499					
5	500 — 599					
6	600 — 699					
7	Main Pool 70	Stations 7100 — 7299	MFMs / TAs 7300 — 7499		Calling Group 770 — 791, 7920 — 7929	Page 793 — 799
8	800*	Trunks 801 — 880			Park 881 — 888	889** Pools 890 — 899
9	ARS Access (Hybrid / PBX Mode) / Idle Line Access 9***					

- * Listed Directory Number (QCC Queue)
- ** Remote Access
- *** System default. Can be changed.

Figure 2-4. Extension Numbers for Set Up Space Numbering Plan

Planning Form Instructions

Use Figures 2-2 through 2-4 as you record extension number information:

1. Identify the 2-digit, 3-digit, or Set Up Space numbering system you will be using under the Factory Set column on Form 2b by circling the name of the appropriate numbering system.
2. Do *one* of the following:
 - If you do *not* need to renumber any of the factory-set extension numbers:
 - a. Check the 2-Digit, the 3-Digit, or the Set Up Space box under the Renumber System heading on Form 2a to indicate the numbering plan you're using.
 - b. Skip to the next section, "Updating Planning Information."

- If you want to renumber only a few of the extensions and there are enough numbers available for 2- and 3-digit numbering plans:
 - a. Check the 2-Digit, the 3-Digit, or the Set Up Space box to indicate the numbering plan you're using. *Be sure to check Selected Extension Numbers under the Renumber System heading on Form 2a, page 1.*
 - b. Write the new extension number(s) in the Renumber to columns on Form 2a and Form 2b.

Proceed to the next section, "Updating Planning Information."

Updating Planning Information

On the floor plan, add the extension number beneath the symbol for each telephone and adjunct. If you are using a system programming console, go to Form 1, System Planning, in the System Operating Conditions section and add the new extension number of the console in the space next to Ext. No.

NOTE:

The remaining columns on Form 2a (Eqpt., Label, Old Ext. No., and Wire No.) are completed by the technician during installation.

To complete the forms for lines/trunks, proceed to Chapter 3, "Lines/Trunks."

Contents

Identifying Line/Trunk Jacks	3-2
■ Module Types and Line/Trunk Jack Types	3-3
LS-ID Delay Option	3-4
■ Incoming Line/Trunk Type	3-6
■ Jacks for Auxiliary Equipment	3-8
■ Function Information	3-10
Selecting Line/Trunk Options	3-11
■ Loop-Start Reliable Disconnect	3-12
■ Outmode Signaling	3-13
■ Toll Type Prefix Required	3-13
■ Hold Disconnect Interval	3-14
■ QCC Operator to Receive Calls (Hybrid/PBX)	3-14
■ QCC Queue Priority Level	3-15
■ Pools (Hybrid/PBX Mode Only)	3-15
■ Remote Access	3-17
■ DS1 Connectivity (100D Module)	3-21
T1 Service	3-22
T1 Switched 56 – Network	3-26
PRI Service	3-27
Module Information	3-28
PRI Options	3-30
■ Tie Trunks	3-35
■ DID Trunks (Hybrid/PBX Mode Only)	3-38
■ NI-1 BRI Connectivity	3-40
Service Profile	3-41
Clock Synchronization	3-43
Timers	3-44
■ Compensating for Slow Dial Tone (International)	3-46
Assigning Lines/Trunks	3-47

Contents

Assigning Telephone Buttons	3-48
■ Telephones in Hybrid/PBX Mode	3-49
Guidelines for Button Assignments	3-51
■ Telephones in Key and Behind Switch Mode	3-53
Factory Assignments	3-53
Guidelines for Button Assignments	3-56
Key Mode	3-56
Behind Switch Mode	3-57
■ Direct-Line Consoles	3-58

Planning for lines/trunks consists of the following tasks:

1. **Identifying Line/Trunk Jacks.** Use the placement of modules in the control unit (see the Control Unit Diagram on Form 1) as a guide to determine in what order to connect trunks to the control unit. To do this, identify the line/trunk jack types available by module and then match trunks and auxiliary equipment with the jacks that support them.
2. **Selecting Line/Trunk Options.** According to the requirements of the customer, choose from available options for the incoming trunks connected to the system.
3. **Assigning Lines/Trunks to User Extensions.** Assign lines/trunks to telephones and DLCs.
4. **Assigning Telephone Buttons.** Assign buttons to Hybrid/PBX mode telephones, to Key and Behind Switch mode telephones, and to DLCs.

This chapter contains instructions for completing each of these tasks. Detailed information about trunks is in the *Equipment and Operations Reference*. You should become familiar with line/trunk types and options, as well as the requirements of the system before you attempt to perform the procedures in this chapter. It is also critical that you understand what services the local telephone company can provide.

Identifying Line/Trunk Jacks

Identifying line/trunk jacks consists of the following tasks:

1. Determining which line/trunk jack types are available according to the types of modules in the control unit
2. Matching incoming trunks to the jacks that support them
3. Designating jacks for auxiliary equipment (if any)

This section contains instructions for completing all of these tasks.

Forms Needed

- Form 1, System Planning
- Form 2c, System Numbering: Line/Trunk Jacks

You also need the local telephone company's line/trunk information.

Module Types and Line/Trunk Jack Types

The line/trunk jack type is determined by the type of module. Table 3–1 lists the line/trunk jack types and the incoming line/trunk or auxiliary equipment that can be connected to these jacks.

Table 3–1. Line/Trunk Jack Types

Module Type	Line/Trunk Jack Type	Number of Jacks	Used to Connect
400 800 408	Loop-start (LS)	4 8 4	Line/Trunk Types: Basic, Special Purpose (FX, WATS) Auxiliary Equipment: Music On Hold, Loudspeaker paging system, Maintenance Alarm, MERLIN Identifier
400 GS/LS 800 GS/LS 408 GS/LS 408 GS/LS-MLX 800 GS/LS-ID	Ground-start/ loop-start (GS/LS)	4 8 4 4 8	Line/Trunk Types: Basic, Special Purpose (FX, WATS) Auxiliary Equipment: Music On Hold, Loudspeaker paging system, Maintenance Alarm, MERLIN Identifier
800 DID (Hybrid/PBX)	DID	8	DID
800 NI-BRI	NI-1 BRI	8 (16 channels)	NI-1 BRI
400EM	Tie	4	Tie
100D	DS1	1 (24 channels)	T1 T1 Switched 56 Data PRI

For detailed information about the module types and their specifications, see the hardware descriptions in the *Equipment and Operations Reference*. For detailed information about line/trunk types, including DS1 (Digital Signal Level 1) facilities and the 100D module and NI-1 BRI facilities and the 800 NI-BRI module, see the functional description of the system in the same book.

NOTES:

1. You cannot mix T1 and Primary Rate Interface (PRI) service on the same 100D module. Any of the following AT&T Switched Network (ASN) Services can be provided through a T1 or PRI facility: Megacom® WATS, Megacom 800, Software Defined Network (SDN), and MultiQuest®. PRI also supports Call-by-Call Service Selection and some ACCUNET® switched digital services. T1 supports Shared Access for Switched Services (SASS) and ACCUNET Switched Digital Service (or other circuit-switched data service) at 56-kbps. Both support Dialed Number Identification Service (DNIS).
2. The MERLIN LEGEND Communications System supports Centrex service with loop-start lines only. The system does *not* support a timed switchhook flash with ground-start trunks or ground-start emulation on DS1 facilities in any mode of operation (Hybrid/PBX, Key, or Behind Switch).
3. The MERLIN LEGEND Communications System does not support timed switchhook flash with NI-1 BRI lines. Pressing the Recall button on a MERLIN LEGEND telephone will be ignored. If the Recall button is stored as part of an Auto Dial string, it will not be sent out over an NI-1 BRI line, or stored for Last Number Dial or Saved Number Dial when calling on an NI-1 BRI line.
4. The MERLIN LEGEND Communications System does not support BRI features such as Local Area Signaling Services (LASS), CO Transfer, and other Centrex offerings.
5. Trunks used for incoming caller line identification (ICLID) service should not have any equipment other than the MERLIN LEGEND line port connected to them. Connecting other equipment (such as alarms, autodialers, and so on) may result in distorted or lost ICLID data.

LS-ID Delay Option

The LS-ID Delay option is available through the 800 GS/LS-ID module and is programmed for each trunk. It prevents applications and adjuncts from answering before the Caller ID information is processed.

Use the LS-ID Delay option only if the following conditions apply:

- If the adjunct or application cannot be programmed to answer on the second or later ring, (see the documentation for the adjunct or application).
- If the first option applies (as with headsets using Auto Answer All) and line buttons receiving Caller ID cannot be programmed for Delay Ring, for example, auto attendants.

NOTES:

1. It is recommended that trunks with the LS-ID Delay option be used as incoming trunks only.
2. If no delay is programmed, the caller may hear one or two extra bursts of ringback while the person receiving the call has not yet heard a ring.

3. If the option is programmed on a 2-way trunk, the system will not seize a trunk from the pool for an outgoing call when that trunk is receiving an incoming call.
4. Use the LS-ID Delay option if the adjunct or application does not allow line buttons to be set for Delay Ring.

Planning Form Instructions

Refer to the completed Control Unit Diagram on Form 1 to mark line/trunk jack types on Form 2c:

1. For each module with line/trunk jacks noted in the Control Unit Diagram (beginning with Slot 01), write in the type of module and its slot number in the Module Type and Slot No. column of Form 2c; after the appropriate Log. ID number, draw a line to indicate the logical IDs (and therefore, the line/trunk jacks) that correspond to that module.

If the system has 100D (DS1) modules, keep in mind that even though the module has only one physical jack, the 100D module supports up to 24 endpoints or extensions. Therefore, 24 logical IDs and associated line/trunk numbers are assigned to each module.

Likewise, the 800 NI-BRI module supports up to 16 endpoints or extensions, therefore 16 logical IDs and associated line/trunk numbers are assigned to each 800 NI-BRI module even though the module has only eight physical jacks.

2. In the Jack Type column of Form 2c, for all modules except 100D modules, write the jack type for each logical ID. Use the codes shown in Table 3-2.

Table 3-2. Codes for Line/Trunk Jacks

Jack Type Code	Line/Trunk Type
LS	Loop-start
GS/LS	Ground-start/loop-start
DID	DID
Tie	Tie
T1-GS	DS1 connectivity used to emulate GS
T1-LS	DS1 connectivity used to emulate LS
T1-Tie *	DS1 connectivity used to emulate tie or for digital data service
T1-DID	DS1 connectivity used to emulate DID
T1-S56	DS1 connectivity used for digital data
PRI	DS1 connectivity used for PRI service
BRI	NI-1 BRI

* T1 Switched 56 digital data is also available using T1-Tie trunks. See the "Tie Trunks" section later in this chapter.

3. For systems that include a 100D module, do *one* of the following in the Jack Type column:
 - If the module will emulate trunks or will be used for digital data transmission, write the appropriate jack type code (see Table 3–2) for the channels being used (for example, **T1-LS**, **T1-TIE**, or **T1-S56**), or write **T1** if the channels are not being used at this time.
 - If the module will connect services (for example, Megacom, Megacom 800, and so on), write **PRI** for all 24 logical IDs of PRI-type modules.

You are now ready to match incoming trunks to these available jacks as described in the next section.

Incoming Line/Trunk Type

Use the procedure in this section to match incoming trunks to the continuous sequence of line/trunk jacks on the control unit, beginning with the first line/trunk jack (logical ID 1).

NOTE:

(Key mode only) If the system is registered with the FCC registration number of AS59CM-7914-KF-E, and the processor module has been modified for Permanent Key mode, you can connect loop-start trunks to the GS/LS type line/trunk jacks. With the KF registration number, ground-start trunks are allowed only when the system includes DS1 connectivity dedicated as a T1 type and the channels are used to emulate ground-start trunks.

This procedure also includes instructions for assigning a label to identify the line/trunk being used.

Planning Form Instructions

1. In the Incoming Line/Trunk Type column of Form 2c, write the type of line/trunk you plan to connect to each line/trunk jack, T1 channel or BRI channel: Main No., personal line, FX (Foreign Exchange), WATS (include band), DID, or Tie. (Contact the local telephone company for line/trunk information.) Use the following guidelines:
 - Group trunks together according to type: basic loop-start or ground-start trunks, and special-purpose loop-start or ground-start trunks. (DID, PRI, T1, BRI and tie trunks are automatically grouped according to type since they require specific types of modules.) The local telephone company supplies the information you need to identify the specific trunks connected to each line/trunk jack on each DID and tie trunk module and each channel on each 100D or 800 NI-BRI module.
 - Use line/trunk jacks at the beginning of the sequence for basic ground-start and/or basic loop-start trunks. Use jacks later in the sequence for special-purpose trunks such as WATS or FX.

- If a line/trunk such as WATS is only inbound or only outbound (not two-way), include that information along with the line/trunk type.
2. If the jack type shown in the Jack Type column is GS/LS, then write either **GS** or **LS** to indicate the line/trunk type in the Incoming Line/Trunk Type column. For a T1 or NI-1 BRI trunk not used at this time, write **unequipped**. For other T1 or PRI facilities, the kind of service connected (such as Megacom 800) will be filled in later.

NOTE:

In the next step, be sure the line/trunk type associated with each telephone number matches the jack type. Also, if you have 800 NI-BRI modules or have dedicated 100D module channels to emulate loop-start, ground-start, and/or tie trunks, the local telephone company will supply the telephone number associated with each of the channels on the BRI or DS1 facility.

3. In the Telephone Number or Equipment column, write the telephone number for each incoming line/trunk (as supplied by the local telephone company) on the row with the logical ID for its line/trunk jack. If you do not know the telephone number, leave the column blank and enter the information later.
4. In the Label column, write the label for each line/trunk on the appropriate line. The labels can contain up to seven characters, including capital letters, numbers, ampersand (&), dash (-), space, colon (:), asterisk (*), and pound sign (#).

The remaining entries on this form are covered in "Selecting Line/Trunk Options," later in this chapter. If the system does not have auxiliary equipment (for example, Music On Hold or a loudspeaker paging system), skip to "Selecting Line/Trunk Options" in this chapter.

Figure 3–1 shows an example of a partially completed Form 2c.

Module Type and Slot No.	Log. ID	Jack Type (LS, GS, DID, Tie, etc.)	Trunk No.	Pool Dial Out Code†‡	Re number To	Incoming Trunk Type (Main No., Personal Line, WATS, FX, etc.)	Telephone Number or Equipment	Label
008 GS/LS 01	1	GS	801			Basic GS	555-1200	1, LOCAL
	2	GS	802			Basic GS	555-1201	2, LOCAL
	3	GS	803			Basic GS	555-1202	3, LOCAL
	4	GS	804			Basic GS	555-1203	4, LOCAL
	5	GS	805			Basic GS	555-1204	5, LOCAL
	6	GS	806			Basic GS	555-1205	6, LOCAL
	7	GS	807			Basic GS	555-1206	7, LOCAL
	8	GS	808			Basic GS	555-1207	
008 GS/LS 02	9	GS	809			Basic GS	555-1208	
	10	GS	810			Basic GS	555-1209	
	11	GS	811			Basic GS	555-1210	
	12	GS	812			Basic GS	555-1211	
	13	GS	813			Basic GS	555-1212	
	14	GS	814			Basic GS	555-1213	
	15	GS	815			Basic GS	555-1214	
	16	GS	816			Basic GS	555-1215	

Figure 3-1. Partially Completed System Form 2c

Jacks for Auxiliary Equipment

Use these instructions only if the system has auxiliary equipment: Music On Hold, MERLIN Identifier, a loudspeaker paging system, or Maintenance Alarm. Otherwise, skip to the next section, "Function Information."

NOTE:

MERLIN Identifier does not require new wiring and is compatible with all system releases.

Only connect auxiliary equipment to loop-start or ground-start/loop-start jack types. You cannot use a line/trunk jack for auxiliary equipment on an 800 DID, 100D, 800 NI-BRI, or 400EM module.

To make it easier to add incoming trunks in the future, connect auxiliary equipment to the last line/trunk jack(s) on the rightmost module with either LS or GS/LS line/trunk jacks.

Planning Form Instructions

1. Review the floor plan and Equipment List (if available) to confirm the auxiliary equipment to be connected.
2. At the top of Form 2c, fill in the line/trunk numbers for each type of auxiliary equipment planned:
 - For Music On Hold, write the line/trunk number of the line/trunk jack designated for this equipment, and identify the music source (tape player, radio, stereo system, or Music On Hold) on the Music On Hold line.

NOTE:

If the system uses equipment that rebroadcasts music or other copyrighted materials, the customer may be required to obtain a copyright license from, and pay license fees to, a third party such as the American Society of Composers, Artists, and Producers (ASCAP) or Broadcast Music Incorporated (BMI). The Magic on Hold® system, which does not require such a license, can be purchased from an AT&T representative.

- For Loudspeaker Paging, on the appropriate row, write the line/trunk numbers (maximum of 3) of the line/trunk jack(s) designated for the paging equipment.
- For Maintenance Alarm, on the appropriate row, write the line/trunk number of the line/trunk jack designated for the Maintenance Alarm external alert.

NOTE:

The last item, Loop-Start Reliable Disconnect, refers to a line/trunk option and is completed later in this chapter.

Function Information

If the system has AUDIX Voice Power/Fax Attendant System™, you can use the Function column to indicate which service is available for those jacks. You can also use this column to indicate whether a jack connects a personal line and, therefore, has an owner.

Planning Form Instructions

In the Function column of Form 2c, do *one* of the following:

- If a jack is used for a special purpose, note the purpose. For example, if the system has AUDIX Voice Power/Fax Attendant System, indicate the service by writing one of the following for the appropriate jack:
 - For Automated Attendant, write **AA**.
 - For Call Answer, write **CA**.
 - For Information Service, write **IS**.
 - For Message Drop, write **MD**.
 - For Voice Mail, write **VM**.
 - For Fax Response, write **FR**.
- If a jack is used for a personal line, write the extension number of the telephone.

Proceed to the next section, "Selecting Line/Trunk Options."

Selecting Line/Trunk Options

You can select the following options for the incoming trunks connected to the system:

- Loop-Start Reliable Disconnect
- Outmode Signaling
- Toll-Call Prefix Dialing Requirements (Toll Type)
- Hold Disconnect Interval
- QCC Operator to Receive Calls (Hybrid/PBX mode only)
- QCC Queue Priority (Hybrid/PBX mode only)
- Pools
- Remote Access
- DS1 Connectivity
- Tie Trunks
- DID trunks
- NI-1 BRI Connectivity

This section contains instructions for selecting line/trunk options for incoming trunks. In addition, because some systems outside of the U.S. have slow dial tones from their local telephone companies, this section also includes instructions for compensating for slow dial tone.

Forms Needed

- Form 1, System Planning
- Form 2c, System Numbering: Line/Trunk Jacks
- Form 3a, Incoming Trunks: Remote Access
- Form 3b, Incoming Trunks: DS1 Connectivity (100D Module)
- Form 3c, Incoming Trunks: Tie
- Form 3d, Incoming Trunks: DID
- Form 3i, Incoming Trunks: BRI Options (800 NI-BRI module)

Loop-Start Reliable Disconnect

Disconnect signals on incoming calls on loop-start trunks are classified as one of the following:

- **Reliable.** A disconnect signal is sent to the system by the local telephone company shortly after a caller hangs up. Loop-start trunks must be reliable for remote call forwarding and trunk-to-trunk transfer. Also, reliable disconnect is strongly recommended for remote call transfers, and VMSs such as MERLIN MAIL VMS.

NOTE:

If the local telephone company uses a short hold disconnect interval, do not specify a reliable disconnect signal. Also, to ensure proper operation of AUDIX Voice Power, the system must have ground-start or loop-start trunks with reliable disconnect.

- **Unreliable.** A disconnect signal is *not* sent by the local telephone company on every call.



SECURITY ALERT:

Toll fraud can occur when loop-start lines/trunks are used with unreliable disconnect. If the calling party stays on the line after the called party hangs up, the central office will return a dial tone at the conclusion of the call enabling the caller to place another call as if it were being placed from your company.

Since the disconnect signal on most loop-start trunks is unreliable, the factory setting for the disconnect signal is Unreliable.

Before you change the setting, check with the telephone company to determine whether the disconnect signals for the loop-start trunks are reliable and to obtain the length of the hold disconnect interval.

If you select Reliable disconnect, you can set the interval after which the line/trunk is released as described in "Hold Disconnect Interval" later in this section.

Trunk-to-trunk transfer is administered on a per-extension basis and may be disabled even if the loop-start trunk has reliable disconnect. See the "Trunk-to-Trunk Transfer" section in Chapter 4 of this manual.

Planning Form Instructions

At the top of Form 2c, under the Loop-Start Reliable Disconnect heading, choose one of the following:

- If the loop-start trunks have an unreliable disconnect signal, check the No box (the factory setting).
- If the loop-start trunks have a reliable disconnect signal, check Yes.

NOTE:

If the system has AUDIX Voice Power/Fax Attendant System, Integrated Administration automatically sets Loop-Start Reliable Disconnect to Yes.

Outmode Signaling

The system is factory-set to generate touch-tone signals when users dial outside calls. Identify any rotary-dial trunks that are connected to the system so that rotary-dial signals can be used for these trunks.

NOTE:

Touch-tone, single-line telephone users cannot make calls using rotary-dial trunks unless their phones allow them to switch between touch tones and rotary dial pulses. Check with the local or long-distance telephone company to determine which, if any, trunks connected to the system are rotary-dial trunks.

Planning Form Instructions

In the Outmode Signaling column on Form 2c, do *one* of the following:

- For touch-tone trunks (factory setting), put a check in the TT column.
- For rotary-dial trunks, put a check in the R column.

Toll Type Prefix Required

Toll Type allows the system to classify calls as either local or toll, based on the number dialed by the user. Normally, people have to dial a toll-call prefix (1 or 0) before dialing the area code and telephone number for a toll call. In some areas this is not necessary; dialing a prefix depends on local telephone company requirements and the type of line/trunk used.

Find out from the local telephone company which trunks require a toll-call prefix. This information is used by the system when a toll call is placed by an extension on ground-start or loop-start trunks.

For reliable toll restriction, telephone company trunks must require 1 or 0 for toll calls. Also, the Toll Type feature does *not* apply to tie trunks.

Planning Form Instructions

On Form 2c, in the Toll Type Prefix Required for LD column, check Yes next to any trunks on which people need to dial a prefix when placing toll calls.

Hold Disconnect Interval

This option allows you to set the number of milliseconds (ms) before the line/trunk is released when a caller on hold hangs up and abandons the call. Local telephone companies use either a long (450 ms) or short (50 ms) interval. The factory setting for the system is the long interval, since it is the interval used by most telephone companies.

Check with the local telephone company for the disconnect interval used. If the local telephone company uses the short interval, you must change the factory setting. If you don't change the setting, when a caller waiting on hold hangs up, the line/trunk is not released.

Planning Form Instructions

In the Hold Disc. Interval column on Form 2c, do *one* of the following:

- To change to a short hold disconnect interval (50 ms), put a check in the Short column.

NOTE:

If the local telephone company uses a short hold disconnect interval, be sure you have checked No for Loop-Start Reliable Disconnect, as described earlier in this section.

- To keep the factory setting, a long hold disconnect interval (450 ms), put a check in the Long column.

QCC Operator to Receive Calls (Hybrid/PBX)

Use these instructions only if the system has one or more QCCs. Otherwise, skip to "Remote Access."

Assigning the QCC operator to receive calls on a line/trunk determines whether incoming calls on the line/trunk ring into the QCC queue and which QCC operator position answers the calls. This applies to Hybrid/PBX mode only.

NOTE:

If an operator presses the programmed Backup On (or Position Busy) button on the console, any incoming calls are directed to other operator positions (regardless of whether they normally receive such calls) or to the programmed backup extension number. For more information, see "Position-Busy Backup" in the "Queued Call Console (Hybrid/PBX Mode Only)" section of Chapter 4.

Planning Form Instructions

For each ground-start, loop-start, and automatic-in tie line/trunk on Form 2c, write *one* of the following in the QCC Operator to Receive Calls column:

- If you do not want the calls received on the line/trunk to ring into the QCC queue, write **No** (factory setting).
- If you want all QCC operators to receive incoming calls on a line/trunk, write **All**.
- If you want to specify one or more QCC operators to receive incoming calls on a line/trunk, write any combination of the extension numbers for up to four operator positions.

If you wrote **All** or specified extension numbers in this procedure, then proceed to the next section, "QCC Queue Priority Level." Otherwise, skip to the following section, "Pools (Hybrid/PBX Mode Only)."

QCC Queue Priority Level

The QCC queue priority determines the order in which calls on each line/trunk are sent to QCC operator positions. You set the priority for each individual line/trunk.

Considerations to be used in deciding the priority level are discussed in the description of Queued Call Console in the *Feature Reference*.

Since incoming calls on DID and non-automatic-in tie trunks route to specific extension numbers, you cannot assign a QCC queue priority for these types of trunks.

Planning Form Instructions

On Form 2c, for each line/trunk with **All** or an extension number in the QCC Operator to Receive Calls column, write the priority level (1 to 7) in the QCC Queue Priority Level column for each line/trunk used for incoming calls. (A value of 1 indicates the highest priority; a value of 7 indicates the lowest. The factory-set priority for calls received on all trunks programmed to ring in the queue is 4.)

Pools (Hybrid/PBX Mode Only)

The system can have up to 11 pools with factory-set dial-out codes of 70 and 890 through 899. When the system is set up, pools are assigned automatically (see the *Feature Reference*). If you want any lines/trunks grouped in a pool, you must manually assign each line/trunk to the pool of your choice. Use the instructions in this section.

Decide whether to change the dial-out codes. Apply the same considerations as you do for reassigning extension numbers.

Planning Form Instructions

1. Use the following guidelines to determine which trunks to group into pools:
 - Each pool should contain trunks of the same type (basic, WATS, FX, or tie). Ground-start and loop-start trunks of the same type (for example, WATS or FX) can be mixed in the same pool.
 - Do not mix different calling areas of WATS or FX trunks to different cities or include both inbound-only or outbound-only trunks within a pool. DID trunks and/or trunks used for auxiliary equipment cannot be grouped in pools. T1 Switched 56 data lines should not be mixed with trunks used for voice calls. If you plan to assign **Pool** buttons on telephones, do not group dial-in-only tie trunks in pools.
 - In typical pooled systems, all the trunks are grouped in pools except those mentioned previously, single special-purpose trunks, and any basic trunks that are needed as personal lines assigned to a button on a telephone.
 - Group the trunks for the main pool first. This should be the local trunks capable of accepting 411, 911, and so on. If your system includes ground-start basic trunks, reassign them from the dial-890 extension pool to the main pool. After these trunks are assigned to the main pool, decide how to arrange the rest of the trunks in the remaining pools.
2. Indicate the dial-out code in the Pool/Dial-Out Code column on Form 2c by doing *one* of the following:
 - To keep the factory set dial-out code, write the code.
 - To change the factory-set dial-out code:
 - a. Write the new number in the Renumber to column.
 - b. On Form 2d, System Numbering: Special Renumbers, write the new number in the Renumber to column of the Pools section of the form.
3. On Form 2c, use the Function column to identify different calling areas of WATS trunks and different destinations for FX trunks.

Proceed to the next section, "Remote Access."

Remote Access



SECURITY ALERT:

The Remote Access feature of your system, if you choose to use it, permits off-premises callers to access the system from a remote telephone by using an 800 number or a 7- or 10-digit telephone number. The system returns an acknowledgment signaling the user to enter his or her barrier code, which is selected and programmed by the system manager. After the barrier code is accepted, the system returns dial tone to the user. If you do not program specific egress restrictions, the user will be able to place any call normally dialed from a telephone associated with the system. Such an off-premises network call is originated at, and will be billed from, the system location.

The Remote Access feature, as designed, helps the customer, through proper programming, to minimize the ability of unauthorized persons to gain access to the network. Most commonly, phone numbers and codes are compromised when overheard in a public location, through theft of a wallet or purse containing access information, or through carelessness (writing codes on a piece of paper and improperly discarding it). Additionally, hackers may use a computer to dial an access code and then publish the information to other hackers.

(See Appendix A, "Customer Support Information," for more information about security.)

Use these instructions only if remote users need access to the system. Otherwise, skip to the next section, "DS1 Connectivity (100D Module)."

The Remote Access feature allows people to use the system from a remote location. It also allows remote system programming and maintenance by a qualified technician.

You can assign remote access to any incoming line/trunk connected to the system except T1 Switched 56 data facilities, and DID and dial-in tie trunks. (For DID, the routing digits supplied by the central office must match the remote access code.)

This section contains instructions for:

- Renumbering the remote access code from the factory setting
- Allowing access to the Automatic Callback feature
- Designating trunks for remote access
- Specifying shared or dedicated access
- Assigning barrier codes and class of restriction for security

For detailed information about these options, see the *Feature Reference*.

You may want to assign remote access to only a few trunks and increase the number later if more are needed.

NOTE:

If you want to allow remote access on DID trunks, the routing digits supplied by the central office must match the factory-set remote access code (889) or the remote access code assigned to the system in the following procedure.



SECURITY ALERT:

The use of DID trunks for remote access is not recommended.

Planning Form Instructions

1. See "Numbering the System" in Chapter 2. Review the numbers available in the numbering plan you have selected. Before you begin planning remote access, check the Control Unit Diagram on Form 1 to verify that one or more of the following types of modules are present: 400, 400 GS/LS/TTR, 008 OPT, 800 DID (Hybrid/PBX mode only), 800 GS/LS-ID, 012, or 016 modules.
2. Under the DID and Tie Trunks heading at the top of Form 3a, Incoming Trunks: Remote Access, do *one* of the following:
 - To keep the factory-set access code, check Remote Access Code: 889 and proceed to Step 3.
 - To change the factory-set access code:
 - a. Check Renumber to and write the new number on the line provided.
 - b. On Form 2d, System Numbering: Special Renumbers, write the new number in the Renumber to column of the Remote Access Code section at the bottom of the form. Proceed to Step 3.
3. Under the Automatic Callback heading at the top of Form 3a, check *one* of the following:
 - If you do not want remote callers to use the Automatic Callback feature, check Disable (factory setting).
 - To allow remote callers to use this feature, check Enable.

4. Under the Barrier Required for Tie Trunks heading, check *one* of the following:
 - If you plan to assign barrier codes to these trunks, check Yes.
 - If no barrier codes are planned for these trunks, check No.



SECURITY ALERT:

To help prevent toll fraud, barrier codes should always be assigned. The barrier codes should also be the maximum length allowed.

5. Under the Barrier Codes Required for Non-Tie Trunks heading, check *one* of the following:
 - If you plan to assign barrier codes to these trunks, check Yes.
 - If no barrier codes are planned for these trunks, check No.



SECURITY ALERT:

To help prevent toll fraud, barrier codes should always be assigned. The barrier codes should also be the maximum length allowed.

6. Remote access should not be assigned to DID trunks and tie trunks that are used for incoming customer calls. However, for all trunks to which you are assigning remote access:
 - a. Transfer the information from Form 2c, System Numbering: Line/Trunk Jacks to Form 3a:
 - (1) Write the logical ID and line/trunk number in the applicable columns.
 - (2) Check either the DID or Tie Trunk column or the Non-Tie Trunk column.
 - (3) Complete the Line/Trunk Type and Description column. Include the different calling areas of WATS trunks and different destinations for FX trunks.
 - b. For each line/trunk, check the Dedicated column (to indicate that it is always used for remote access) or the Shared column (to indicate that it is used for remote access when the system is in Night Service operation)

7. For Class of Restriction without Barrier Codes on Form 3a (page 3), complete the DID and Tie Trunks and Non-Tie Trunks sections as follows:
 - a. For Restriction, check one of the following three boxes: Unrestricted, Outward Restrict (to keep the factory setting), or Toll Restrict.



SECURITY ALERT:

It is recommended that Outward Restrict be set at all times, otherwise toll fraud can occur.

- b. Under the Allowed List Access and Disallowed List Access headings, check the boxes if you plan to assign these lists.

NOTE:

Instructions for filling in the ARS Restriction Level and Allowed and Disallowed List numbers are included in Chapter 4, "Features."

8. Form 3a (page 4) identifies programming information for four barrier codes. If more barrier codes are planned, make the appropriate number of copies of Form 3a, page 4. A maximum of 16 barrier codes is allowed.



SECURITY ALERT:

Barrier codes of at least 11-digits should be assigned to help prevent toll fraud.

For Class of Restriction with Barrier Codes on Form 3a (page 4), do the following for each barrier code:

- a. Write the barrier code number in the space provided, numbering them sequentially beginning with 1.
 - b. Write the 4- to 11-digit barrier code in the Digits space. The star is added to the end of the barrier code. For security reasons, you may want to record the code elsewhere.
 - c. For Restriction, check one of the following three boxes: Unrestricted, Outward Restrict (to keep the factory setting), or Toll Restrict.
 - d. Under the Allowed List Access and Disallowed List Access headings, check the boxes if you plan to assign these lists.

NOTE:

Instructions for filling in the ARS Restriction Level and Allowed and Disallowed List numbers are included in Chapter 4, "Features."

Proceed to the next section, "DS1 Connectivity (100D Module)."

DS1 Connectivity (100D Module)

Use these instructions only if the system has a 100D module. Otherwise, skip to "Tie Trunks."

DS1 (Digital Signal 1) connectivity involves the transmission of digital signals in DS1 format. The interface enabling the system to allow DS1 connections is the 100D module. The system can have up to three 100D modules. Each 100D module supports up to 24 logical endpoints (IDs) or ports (one for each channel), even though the module has only one jack.

The 100D module can be configured to operate with either of the following types of service:

- **T1** (factory setting). To transmit and receive voice and analog data and, with T1 Switched 56 service, digital data.
- **PRI** (Primary Rate Interface). To transmit and receive voice, analog, and digital data.

To ensure proper protocol between both ends of the DS1 connection, the following options should be set for both types of service:

- Type of Service
- Frame Format
- Suppression (Line Code)
- Signaling mode
- Line Compensation
- Clock Synchronization
- Channel Service Unit (CSU) setting

Additional settings must be entered for both services, especially for PRI and T1 Switched 56 service. Appropriate settings are determined by the transmission facility to which the module is connected and/or is supplied by the service provider. This section contains instructions for both T1 and PRI services.

NOTE:

PRI service for Release 2.0 and later systems requires that the service provider's switching equipment be either a 4ESS™ Generic 13 through 16, 5ESS® Generic 6, or a 5ESS serving the FTS2000 (federal government only) network. PRI service for a Release 1.0 or Release 1.1 system requires that the switching equipment be a 4ESS Generic 13 through Generic 16 switch.

Because of the complexity of DS1 connectivity planning, you must review the information in the *Equipment and Operations Reference* before you begin this section and as you work through these instructions.

Planning Form Instructions

On Form 2c, System Numbering: Line/Trunk Jacks:

1. For all trunks listed as "PRI" in the Jack Type column:

NOTE:

You cannot use Channel 24 for services.

- a. Write the kind of service to be connected to each channel in the Incoming Line/Trunk Type column.
 - b. Write **unequipped** in the Incoming Line/Trunk Type column for any channel not used at this time.
2. For all trunks listed as T1-Tie that do not show an **unequipped** entry in the Incoming Line/Trunk Type column, write the kind of service connected to each channel in the Incoming Line/Trunk Type column.

NOTE:

If you use common-channel signaling, you cannot use Channel 24 and program the module for tie-trunk emulation.

3. Do *one* of the following:
 - To select settings for T1 and T1 Switched 56, continue to the next section, "T1 Service." For T1 Switched 56 service, you must also complete the "T1 Switched 56" section.
 - To select settings for PRI, skip to "PRI Service."

T1 Service

T1 service allows the emulation of different analog lines. You can also order services, such as Megacom 800, over the channels. The capacity, however, is limited to voice calls and data calls using a modem. In addition, with Release 4.0 of the MERLIN LEGEND Communications System, T1 supports ACCUNET Switched Digital Service (or other circuit-switched data service) at 56-kbps when the T1 channel or T1-Tie trunk is configured as T1 Switched 56.

The planning form instructions below apply to both T1 and T1 Switched 56 service except where noted. If you are configuring channels for T1 Switched 56 service, complete these instructions then proceed to the "T1 Switched 56 – Network" section that immediately follows. If configuring T1-Tie trunks for T1 Switched 56 service, proceed to the "Tie Trunks" section after completing these instructions.

Planning Form Instructions

On Form 3b (page 1), Incoming Trunks: DS1 Connectivity (100D Module), for each 100D module in the system:

1. In the Module Slot No. space, write the number of the control unit slot that contains the module (see the Control Unit Diagram on Form 1).

NOTE:

If more than one 100D module is used, complete the first box, Module 1, to show the options assigned to the 100D module in the lowest number control unit slot. Use the second box for the second lowest-numbered slot, and the last box for the highest-numbered slot.

2. Under Type of Service, check T1 (the factory-setting).

NOTE:

For T1 or T1 Switched 56 service, the T1 box must be checked on the form. (If you leave this blank, and T1 is not specified during programming, the 100D module will not be programmed.)

NOTE:

Steps 3, 4, 5, and 6 must match the service provider settings. Check with the provider if necessary. See "Obtaining Telephone Company Information," in Chapter 1, for more information.

3. In the table under the T1 Trunks heading, write the channel number(s) for each trunk type and/or, for Tie or All Tie, check the Tie-PBX, Toll, or S56 boxes.
4. Under the Frame Format heading, do *one* of the following:
 - To retain the factory setting, check D4 Compatible.
 - To change the factory setting, check Extended Superframe (ESF).
5. Under the Suppression (Line Code) heading, do *one* of the following:
 - To retain the factory setting, check AMI-ZCS.
 - To change the factory setting, check B8ZS.
6. Under the Signaling Mode heading, for all boxes that describe T1 modules, do *one* of the following:
 - To retain the factory setting of robbed-bit signaling, check Robbed-Bit Signaling (RBS).
 - To change the factory setting to common-channel signaling, check Common-Channel Signaling (CCS).
7. Under the Line Compensation heading:
 - a. Fill in the approximate distance (number of cable feet) between the 100D module and its channel service unit (CSU) or other far-end connection in the space provided next to Cable Feet.
 - b. Use Table 3–3 to select the Line Compensation setting needed. (The factory setting is a value of 1.)

Table 3-3. Line Compensation Settings

Setting	dB Loss	Cable Feet*
1 (factory setting)	-0.6	0–133
2	-1.2	133–266
3	-1.8	266–399
4	-2.4	399–533
5	-3.0	533–655

* Based on 22-gauge cable.

8. If the system includes both 800 NI-BRI and 100D modules, clock synchronization planning should be completed at the same time. There is only one primary/secondary/tertiary clock for both 800 NI-BRI modules and 100D modules, with the same system programming screens used for both types.

Plan your clock source administration to minimize the need for clock switching, which is known to cause noise on active calls.

Under Priority in the Clock Synchronization section, do *one* of the following:

- If installing only one 100D module:
 - To keep the factory setting, check Primary (that is, this module provides synchronization for the system.)
 - If the synchronization source is other than through the 100D module, check None.
- If installing more than one 100D module, decide which module, if any, provides the primary synchronization:
 - If Module 1 provides clock synchronization, check Primary in the first box (the factory setting).
 - If Module 2 (or Module 3) provides clock synchronization, check Primary in the box that describes that 100D module.
 - If the synchronization source is other than through a 100D module, check None.

9. If assigning backup synchronization:
 - a. In the box that describes the 100D module providing secondary synchronization, check Secondary.
 - b. In the box that describes the 100D module providing tertiary back up, check Tertiary.
10. Under the Source subheading in each box, do *one* of the following:
 - To retain the factory setting, check Loop (that is, the system uses the clock of the far-end connection).
 - To change the setting, check Local (that is, the clock is free-running).

NOTE:

The MERLIN LEGEND system must be set to Loop if the clock Source is coming from the network. The Local setting is generated from the MERLIN LEGEND system and must be used whenever connecting two MERLIN LEGEND systems or a MERLIN LEGEND system and a DEFINITY system (Tie trunk). In a Tie trunk configuration, one system *MUST* have the clock Source set to Local and the other *MUST* be set to Loop.

11. Under the Activation subheading in each box, do *one* of the following:
 - If loop clock synchronization is taking place, check Active (factory setting).
 - If the clock is free-running, check Not Active.

NOTE:

Normally, the primary synchronization source is set to Active and other modules are set to "Not Active."

12. If incoming ground-start or loop-start trunks are to be emulated, then record the CSU setting under the Channel Service Unit heading by doing *one* of the following :
 - To retain the factory setting, check Foreign Exchange.
 - To change the factory setting, check Special Access.

To set up T1 channels for T1 Switched 56 service, continue with the next section. To set up T1 Switched 56 service on T1-Tie trunks, proceed to the section entitled "Tie Trunks." To set up a 100D module for PRI service, proceed to the section entitled "PRI Service."

T1 Switched 56 – Network

Use these instructions only if channels on a 100D module are to be programmed as T1 Switched 56 channels. The instructions provided in the “T1 Service” section must be completed first.

T1 Switched 56 service provides high speed digital data services (up to 56-kbps per channel) to the network as well as digital Tie trunk services. This allows you to use your T1 facilities for basic digital data and file transfer needs as well as more sophisticated personal and/or group video conferencing.

NOTES:

1. T1 Switched 56 service is supported only in Hybrid/PBX or Key mode.
2. Incoming data calls that attempt to route to busy data endpoints, unassigned Dial Plan numbers, or ports that are not equipped with data endpoints will not be connected.

This section contains instructions for configuring those T1 Switched 56 options that apply to the T1 network interface. For information specific to the digital Tie trunk planning, refer to the “Tie Trunks” section of this chapter.

The following options are covered in this section:

- Incoming Routing
 - Line Appearance Routing (incoming services)
 - Dial Plan routing (incoming services; Hybrid/PBX mode only)
- Signaling

After completing the procedure for filling in the module information on Form 3b, pages 1 and 2, continue to the next section to fill in T1 Switched 56 options.

Planning Form Instructions

1. Select an Incoming Routing Method. This also assigns the Incoming Signaling Type.
 - **Line Appearance Routing** (default). When selected, incoming data calls are typically terminated at a data extension/endpoint that has a DFT or DPT appearance. The call may also terminate at a data extension/endpoint in a DGC group. This option sets the incoming signaling type to Auto.
 - **Dial Plan Routing**. When selected, incoming data calls are routed by Dial Plan and may terminate to an SA button on any data extension within the system. When routing by dial plan, the incoming signaling type options are Wink Start and Delay Start.

2. If Dial Plan Routing was selected, you may have to manipulate the incoming digits by absorbing, deleting, or adding digits. This is because, in many cases, the digits that are sent by the service provider may not match the administered Dial Plan. Enter the following information:
 - **Expected Number of Digits.** Enter the expected number of digits (1–4). The factory setting is 3.
 - **Number of Digits to Delete.** Enter the number of digits to delete (0–4) in order to match the Dial Plan. The factory setting is 0.
 - **Number of Digits to Add.** Enter the number of digits to add (0–9999) to the collected digits in order to determine a routing pattern. The factory setting is 0.
3. Select the Channel Direction.
 - Select either Incoming, Outgoing, or Two Way.
4. Select and Outgoing Signaling Type.
 - Select either Wink, Auto, or Delay. The factory setting is Wink.
5. Select both the Incoming and Outgoing Signaling Mode.
 - Select either Touch Tone or Rotary. The factory setting is Rotary.

PRI Service

Use these instructions only if the type of service on a 100D module is PRI. Otherwise, skip to the next section, "Tie Trunks."

PRI is a standard access arrangement of Integrated Services Digital Network (ISDN) service that may be used to connect the system to another switch over a DS1 facility.

This section contains instructions for recording decisions about the following options for each PRI facility:

- B-channel groups
- PRI services (incoming and outgoing) according to B-channel group
- Line Appearance Routing (incoming services)
- Dial Plan Routing (incoming services; Hybrid/PBX mode only)
- Outgoing Tables (Network Selection Table, Special Services Table, and Call-by-Call Service Table)
- Telephone Number to Send station identification or automatic numbering information (SID-ANI) information

- Test Telephone Number(s)
- Timers and Counters
- Terminal Equipment Identifier (TEI)

After completing the procedure for filling in the module information on Form 3b, pages 1 and 2, continue to the next section to fill in PRI options.

NOTES:

1. The PRI service type must be selected before entering the PRI information during system programming. For detailed information, see the *Equipment and Operations Reference*.
2. Because of the complexity of the timer, counter, and terminal equipment identifier information, the factory settings should rarely be changed. Incorrect settings can have an adverse affect on the operation of PRI facilities.
3. If there is more than one 100D module set up for PRI service or you have more than eight B-channel groups assigned to a module, make copies of Form 3b (page 4) as necessary.

Module Information

Use the procedure in this section to fill in module information on pages 1 and 2 of Form 3b, Incoming Trunks: DS1 Connectivity (100D Module). Then proceed to the next section, "PRI Options."

Planning Form Instructions

On Form 3b (page 1), Incoming Trunks: DS1 Connectivity (100D Module), for each 100D module with PRI service:

1. In the module Slot No. space, write the number of the control unit slot that contains the module (see the Control Unit Diagram on Form 1).

NOTE:

If more than one 100D module is used, complete the first box, Module 1, to show the options assigned to the 100D module in the lowest-numbered control unit slot. Use the second box for the second lowest-numbered slot and the last box for the highest-numbered slot.

2. Under the Type of Service heading, check PRI. (During programming, PRI must be selected here *before* the PRI options information is entered. When it is selected, the system restarts.)
3. Under the Frame Format heading, change the factory setting by checking the Extended Superframe (ESF) box.
4. Under the Suppression (Line Code) heading, change the factory setting by checking the B8ZS box.

5. Under the Signaling Mode heading, check Common-Channel Signaling (CCS).

NOTE:

Common-Channel Signaling (CCS) is automatically assigned when PRI is selected. Also, Channel 24 cannot be used for voice or data transmissions.

6. Under the Line Compensation heading:
 - a. Fill in the approximate distance (number of cable feet) between the 100D module and its CSU or other far-end connection in the space before Cable Feet.
 - b. Use Table 3–4 to select the line compensation setting needed. (The factory setting is a value of 1.)

Table 3–4. Line Compensation Settings (Based on 22-Gauge Cable)

Setting	dB Loss	Cable Feet*
1 (factory setting)	-0.6	0–133
2	-1.2	133–266
3	-1.8	266–399
4	-2.4	399–533
5	-3.0	533–655

* Based on 22-gauge cable.

7. If the system includes both 800 NI-BRI and 100D modules, clock synchronization planning should be completed at the same time. There is only one primary/secondary/tertiary clock for both 800 NI-BRI modules and 100D modules, with the same system programming screens used for both types.

Plan your clock source administration to minimize the need for clock switching, which is known to cause noise on active calls.

Under Priority, in the Clock Synchronization section, do *one* of the following:

- If installing only one 100D module:
 - To keep the factory setting, check Primary (that is, this module provides synchronization for the system).
 - If the synchronization source is other than through the 100D module, check None.
 - If installing more than one 100D module, decide which module, if any, provides the primary synchronization:
 - If Module 1 provides clock synchronization, check Primary in the first box (the factory setting).
 - If Module 2 (or Module 3) provides clock synchronization, check Primary in the box that describes that 100D module.
 - If the synchronization source is other than through a 100D module, check None.
8. If assigning backup synchronization:
- a. In the box that describes the 100D module providing secondary synchronization, check Secondary.
 - b. In the box that describes the 100D module providing tertiary back up, check Tertiary.
9. Under the Source subheading in each box, do *one* of the following:
- To retain the factory setting (that is, the system uses the clock of the far-end connection), check Loop.
 - To change the setting (the clock is free-running), check Local.
10. The typical setup for the primary synchronization source is Active, and other modules are set to Not Active. Under the Activation subheading in each box, do *one* of the following:
- If loop clock synchronization is taking place, check Active (factory setting).
 - If the clock is free-running, check Not Active.
11. Under the Channel Service Unit heading, check Foreign Exchange.

PRI Options

After you have completed the module information on pages 1 and 2 of Form 3b, Incoming Trunks: DS1 Connectivity (100D Module), use the instructions in this section to record PRI options:

- Assigning B-channels to groups
- Associating outgoing and incoming services to the groups

- For groups with incoming services, selecting an incoming routing method (Dial Plan Routing or Line Appearance) and providing routing information
- For groups with outgoing services, completing the Network Selection, Special Services, and Call-by-Call Service tables
- Identifying the trunk and telephone numbers sent to the network for caller identification
- Assigning a test number used for maintenance by the service provider, changing timers and counters from the defaults, and assigning the Terminal Equipment Identifier (TEI)

All channels assigned to a group must be on the same 100D module. Also, the order of the B-channel groups is not important. However, the order in which channels are assigned within a group should be the exact opposite of the order in which the telephone company's switch hunts through for a channel. Consult with the service provider to determine what the correct order should be.

When programmed for PRI, the single DS1 jack on the 100D module supports 23 B-channels (the Channel 24 superframe transmits signaling mode information).

Planning Form Instructions

1. To assign B-channels to groups, determine which channels to group together and then record each group on Form 3b (page 3), under the B-Channel Groups heading:
 - a. Write the group number (1–80) under the B-Channel Group No. heading (start with 1 and number sequentially).
 - b. Write the slot and port number of each B-channel assigned to the group (see Form 2c, System Numbering: Line/Trunk Jacks). To determine the port number, assume that port 1 is at the bottom of the module to which you are assigning B-channels.
 - c. For all channels you plan to associate with the group, write the trunk number (see Form 2c, System Numbering: Line/Trunk Jacks).
2. To assign service to each B-channel group, complete Form 3b (page 4) as follows: If there is more than one 100D module set up for PRI service or you have more than eight B-channel groups assigned to a module, make copies of Form 3b (page 4) as necessary.
 - a. In the Module Slot No. space, write the number of the control unit slot that contains the module as noted on pages 1 and 2 of this form.
 - b. Under the B-Channel Group No. heading, copy the B-Channel group numbers from Form 3b (page 3).

- c. Write the services to be associated with each group under the Outgoing Services and Incoming Services headings. Select from the following services:
 - **AT&T Toll.** Megacom WATS, Megacom 800, ACCUNET SDS, Software Defined Network (SDN), MultiQuest, and Long Distance.
 - **Local.** OUTWATS, 56/64 Digital, Virtual Private Network, and INWATS.
 - **Other.** Call-by-Call, Other.

NOTE:
If a B-channel group has more than one outgoing service, then enter Call-by-Call on Form 3b, page 4, under the Outgoing column instead of itemizing the services. Form 3b, page 8, is where you enter specific services with specific dial-out patterns.
- d. If the group has incoming services assigned, do *one* of the following:
 - If the routing will be Dial Plan Routing (Hybrid/PBX mode only), check Dial Plan Routing.
 - If the routing will be by line appearance, check Line Appearance.
3. For all B-channel groups that are programmed to route calls by line appearance, assign a telephone number to each line in the B-channel group. Record the information on Form 3b (page 5):
 - a. Write the B-channel group numbers and the trunk number(s) from Form 3b (page 3).
 - b. In the Telephone Number column, write the unique inbound routing telephone number (the "directory number") of up to 12 digits, furnished by the PRI service provider.

NOTE:
The factory does not preassign a telephone number. The telephone number you assign should be the same sent to the system by the network. The number should also be unique within the same B-channel group and must be different from the associated test telephone number. (Test telephone numbers are assigned later in this procedure.)
4. For all B-channel groups you plan to assign to Dial Plan Routing, you must program the Dial Plan Routing table to direct the system to properly route calls. Record table entries (maximum: 16 entries) on Form 3b (page 6):
 - a. For the entry to be activated, a service must be entered. In the Service cell, write *one* of the following:
 - **AT&T Toll.** Megacom WATS, Megacom 800, ACCUNET SDS, SDN, MultiQuest, or Long Distance.

- **Local.** OUTWATS, 56/64 Digital, Virtual Private Network, or INWATS.
 - **Other.** All services, Other, or No service.
- b. In the Pattern to Match cell, write the exact pattern to match if you have more than 1 block of incoming numbers. If you want to match any pattern, leave it blank.
 - c. In the Total Digits in Dialed Number cell, write the total number of digits (0–14) expected in the dialed number; 0 is a wildcard, that is, match any number. (Contact the service provider for the appropriate number.)
 - d. After the match has been made, do *one* of the following to enable the system to determine where to direct the call:
 - To delete digits, write the number of digits to delete (0–14). (The system deletes from the first digit onward.)
 - To add digits, write the exact digits to enter (up to four digits) as a prefix, for example, 7128. The factory setting is blank. (The system adds the digits to the beginning of the number.)
5. In the Network Selection Table of the outgoing tables on Form 3b (page 7), the dial pattern represents the dial code for specifying a long-distance common carrier; the asterisks represent the digits in the common carrier identification. If the telephone company has directed you to change this information, obtain the correct entry from them. But note that the dial pattern must come first. Entry 1 represents current national standards for specifying long-distance carriers (asterisks represent the common carrier code wildcard so that anything will match). Entry 0 represents the coming national standards. The remaining entries are reserved for future use.

NOTE:

The Network Selection Table and the Special Services Table contain factory settings that reflect U.S. standards for public telephone network access. These factory settings can be modified to conform to other standards. However, you should not change them unless the telephone company explicitly instructs you to do so.

6. In the Special Services Table:
- a. In the Pattern to Match cell, write the exact dial pattern to match. (No wildcards are permitted.)
 - b. In the Operator cell, indicate Local Operator (OP), Presubscribed Operator (P), or No Operator service (none) associated with the pattern.
 - c. In the Type of No. cell, indicate whether the pattern is for calling National (N) or International (I).

- d. To delete digits, write the number of digits to delete (0–4). (The system deletes from the first digit forward.)
- 7. For all call-by-call B-channel groups, to route all outgoing calls over a call-by-call B-channel group, you must program the Call-by-Call Service Table to direct the system to properly route calls. Record table entries (maximum: 10) on Form 3b (page 8):
 - a. In the Pattern to Match cell, write the dial pattern to match (up to 8 digits). No wildcards are permitted.
 - b. In the Call Type cell, indicate the type(s) of calls that will be associated with the pattern by doing *one* of the following:
 - If all outgoing calls will be voice calls (for example, Megacom WATS), write **Voice**.
 - If all outgoing calls will be data only (for example, ACCUNET), write **Data**.
 - If outgoing calls may be either voice or data (for example, SDN), write **Both**.

NOTE:

If you indicate Both, make sure the service can support both voice and data calls.

- c. In the Service cell, write *one* of the following:
 - **AT&T Toll.** Megacom WATS, ACCUNET SDS, SDN, or Long Distance.
 - **Local.** OUTWATS, 56/64 Digital, or Virtual Private Network.
 - **Other.** Other, or No service.
- d. If the system will need to delete digits, write the number of digits to delete (0–8). (The system deletes from the first digit onward.)
- 8. On Form 3b, check the appropriate box for the information that will be sent to the network for outgoing PRI calls. Check Extension Only, Base Number with Extension, or Line Telephone Number.

If you check Line Telephone Number, do the following:

- Identify the trunk number.
- Write the up to 12-digit telephone number that identifies the company as the caller in the Telephone Number to Send column.

NOTE:

There is no factory-assigned telephone number. If you assign a number, it does not have to be unique. Also, the availability of caller identification information may be limited by your local-serving jurisdiction, availability, or central office equipment.

9. If available, assign a test telephone number that is used for maintenance by the service provider. For each 100D module with a PRI service type, write the test telephone number (up to 12 digits) used for maintenance next to the module number under the Test Telephone Numbers heading on Form 3b (page 10).

NOTE:

The factory does not assign a test telephone number. You must assign the same number as that furnished by the PRI service provider. It must be different from the numbers assigned to other channels associated with the same B-channel group.

10. Under the Timers and Counters heading do *one* of the following:
 - To keep the factory setting, leave the Change to column blank.
 - To change the factory setting for any timer or counter, write the new threshold on the appropriate line in the Change to column.
11. Under the Terminal Equipment Identifier (TEI) heading, do *one* of the following:
 - To keep the factory-set TEI, check 0.
 - To change the factory-set TEI, write a value from 1 to 63 in the space provided.

NOTE:

If the system includes DS1 connectivity, all local offerings of DS1 configurations must be reviewed by AT&T National Technical Marketing (NTM) personnel to ensure compatibility. For more information, see Appendix D, "T1/PRI Review." Also, information required by the facilities vendor is discussed in Appendix E, "DS1 Connectivity Ordering."

Tie Trunks

Use these instructions only if the system has tie trunks, including tie trunks emulated through a DS1 connection. Otherwise, skip to the next section, "DID Trunks (Hybrid/PBX Mode Only)."

If configuring T1-Tie trunks, including those with Switched 56 digital data service, complete the instructions in the "T1 Service" section first.

Tie trunks must be configured to match central office requirements or the configuration of the system to which they tie. Review tie trunk operations and make the following decisions about the way each tie trunk operates:

- Direction
- Signaling type
- E & M Signaling
- Dial mode

- Dial tone
- Answer supervision time
- Disconnect time

This section contains instructions for each of these options. For detailed information about DID trunks, see the *Equipment and Operations Reference*.

Planning Form Instructions

1. Transfer the trunk identification from Form 2c, System Numbering: Line/Trunk Jacks, to Form 3c, Incoming Trunks: Tie. Write the logical ID and trunk number for each tie trunk connected to the system.
2. Under the Direction heading on Form 3c, check the direction for each tie trunk next to its trunk number:
 - If the tie trunk is two-way, check the Two Way (factory-setting) column.
 - If the trunk is one-way, check either the Outgoing column or the Incoming column.
3. Under the Signaling Type (Intype/Outtype) heading, check the appropriate column for either In or Out under the Wink, Delay, Immediate, or Automatic columns for each tie trunk. For T1 facilities used for services (for example, Megacom), consider the direction of the tie trunk and how trunk assignments will be made. Then select from the following:

NOTES:

1. Check the same signaling type used by the system to which you are connecting. For incoming-only or two-way tie trunks, the incoming type must be the same as the outgoing type of the remote system. For outgoing-only or two-way tie trunks, the outgoing type must be the same as the incoming type of the remote system.
2. Wink is the factory setting and is the preferred type, followed by Delay then Immediate. Immediate does not work with touch-tone dial mode.
3. Immediate Dial incoming signaling is required if the CO switch is an AT&T 5ESS or Northern Telecom DMS-100 and incoming calls are administered to route by Line Appearance. Immediate Dial outgoing signaling should not be used for digital emulated Tie trunks using T1 Switched 56 service due to the lack of trunk integrity checking.
 - **One-way, Outgoing Tie Trunks.** All outgoing calls are placed using Automatic Route Selection, and tie trunks are not assigned to personal line or **Pool** buttons on telephones. Select wink signaling.

- **One-way, Outgoing Tie Trunks.** Tie trunks are assigned to personal line or **Pool** buttons on telephones. Select immediate signaling.
 - **One-way, Incoming Tie Trunks.** Dialed Number Identification Service (DNIS) is included. Select wink signaling.
4. Under the E&M Signal heading, select *one* of the following signaling types to be used on the tie trunks:

NOTE:

E&M Signaling does not apply to digital emulated Tie trunks using T1 Switched 56 service and should not be set during administration of those trunks.

- If the tie trunks are connected to the other system through the local telephone company, check 1S (the factory setting).
- If the tie trunks are connected directly to a system that uses type 1S signaling and is located near this system, check 1C.

NOTE:

The 1C option assumes that the two systems are connected together without any provisioned facility, and without any signaling treatment equipment.

- If the tie trunks are connected directly to a system that uses type 5 signaling and is located near this system, check 5.
5. To select dial mode:
- a. Under the Inmode heading, check either the Touch-Tone column or Rotary column (factory setting) for each incoming-only and each two-way tie trunk.

NOTES:

- 1. If you have checked the Incoming or two-way column for a tie-trunk's direction and Immediate for its incoming signaling type, you cannot use the Touch-Tone setting for Inmode.
 - 2. Touch-Tone outmode can be used with Outtype Immediate trunks, but Touch-Tone Inmode cannot be used with Intype Immediate Trunks.
- b. Under the Outmode heading, check either the Touch-Tone column or the Rotary column (factory setting) for each outgoing-only and each two-way tie trunk.
6. To indicate whether the system provides a dial tone for people calling in on a tie trunk, check *one* of the following for each tie trunk under the Dial Tone heading:
- If the system provides a dial tone, check Remote (factory setting).
 - If the system does *not* provide a dial tone, check Local.

7. For Answer Supv. Time, do *one* of the following:
 - To keep the factory setting, check the 300 column.
 - To change to a new value, write the new value (20 to 4800 ms) in the Other column. (Use 20-ms increments.)
8. Under the Disconnect Time heading, do *one* of the following:
 - To keep the factory setting, check the 300 column.
 - To change to a new value, write the new value (140 to 2400 ms) in the other column. (Use 10-ms increments).

Proceed to the next section, "DID Trunks (Hybrid/PBX Mode Only)."

DID Trunks (Hybrid/PBX Mode Only)

Use these instructions only if Direct Inward Dial (DID) trunks are connected to the system. Otherwise, skip to the next section, "Assigning Trunks."



SECURITY ALERT:

DID numbers that correspond to the remote access code can be used to make calls on the system's trunks, leading to toll abuse and/or fraud. (See Appendix A, "Customer Support Information," for more information about security.

This section contains instructions for setting the following options for DID trunks:

- Type of DID Trunks
- Expected Digits
- Delete Digits
- Add Digits
- Signaling
- Invalid Destination
- Trunks Included in Blocks

These options are assigned to blocks of trunks. A maximum of two blocks is permitted.

If you want to allow Remote Access on DID trunks, one of the telephone numbers assigned by the telephone company must match the remote access dial code. The factory setting is 889.

If two-way DID service is available from the local telephone company, it is typically set up as Tie Trunks service.

For detailed information about DID trunks and these options, see the *Equipment and Operations Reference*.

NOTE:

If the system will have two blocks, make a copy of Form 3d and write the block number in the Block Number space. Check with the local telephone company to determine the number of digits sent.

Planning Form Instructions

1. On Form 3d, under the Type heading, do *one* of the following:
 - To keep the factory setting, check the Wink-Start box.
 - To change the type, check the Immediate-Start box.
2. Under the Expected Digits heading on Form 3d, do *one* of the following:
 - To show that the telephone company sends the factory-set number of digits, check the box labeled 3.
 - To show the number of digits sent by the telephone company, check one of the boxes labeled 1, 2, or 4.
3. Compare the number of digits sent by the local telephone company to the number of digits in the system numbering plan, and do *one* of the following:
 - If the system's numbering plan matches the number of digits sent by the telephone company, check 0 (the factory setting) under the Delete Digits and Add Digits headings.
 - If the number of digits sent by the local telephone company is *more* than the number of digits in the system numbering plan, specify that one to four digits be deleted from the telephone company digits by checking the appropriate number (1, 2, 3, or 4) under the Delete Digits heading.
 - If the number of digits sent by the local telephone company is *fewer* than the number of digits in the system's numbering plan, specify the specific digits (1–9999) to be added to the digits sent; check the Add these digits box under the Add Digits heading and then write the specific digits to be added in the space provided.
4. Under the Signaling heading, do *one* of the following:
 - To keep the factory-set signal, check Rotary.
 - To change the setting, check Touch-Tone. (You cannot have touch-tone if you selected Immediate-Start.)

5. Under the Invalid Destination heading, do *one* of the following. (The Invalid Destination setting applies to both blocks. You cannot specify a different setting for each block.)
 - To indicate that calls to unassigned extension numbers go to the backup position (usually the primary operator), check Send to backup position.
 - To indicate that calls to unassigned extension numbers should receive a fast busy signal, check Return to fast busy.
6. Group DID trunks into each block by assigning the DID trunks according to how incoming calls must be routed to reach the proper extension numbers, and transfer the information from Form 2c, System Numbering: Line/Trunk Jacks to the Trunks included in Block section of Form 3d. Write the logical ID, trunk number, and telephone number in the applicable columns.
7. Select the disconnect time for each DID trunk by doing *one* of the following under the Disconnect Time heading:
 - To keep the factory setting, check 500 ms.
 - To change the disconnect time, write the new value (10 to 2550) in the Other column.

If this system is installed outside of the U.S., continue to the next section. Otherwise, skip to the following section, "Assigning Lines/Trunks."

NI-1 BRI Connectivity

To ensure proper operation of the BRI line features, the following options must be set on the MERLIN LEGEND system during system programming:

- Service Profile Identifier (SPID) for each BRI line B-channel
- Directory Number (DN) for each BRI line B-channel
- Clock Synchronization for the system
- Timers for each BRI module (system provides defaults)

The following affect the operation of the MERLIN LEGEND system, however they are administered on the Central Office (CO) switch:

- Service Configuration of the BRI lines (IOC "S", Multi-Line Hunt)
- Hunting pattern for a Multi-Line Hunt configuration

Service Profile

A Service Profile (SP) defines the interface on a BRI line between a CO and an ISDN terminal. It specifies the parameters and their values necessary to provide services to the terminal. There are standardized capability packages called ISDN Ordering Codes (IOCs) that are configured on the CO at subscription time. The IOC contains information necessary for the CO to provide service to the system.

The MERLIN LEGEND system supports the IOC "S" capability package, which provides alternate voice/circuit-switched data on two B-channels with no packet data capability or supplementary voice features, except for the Calling Party Number/Billing Number (CPN/BN) feature if available.

In addition to the IOC "S" capability package, the MERLIN LEGEND system supports Multi-Line Hunt (MLH) service for *alternate voice and data* hunting if the CO is an AT&T 5ESS or Northern Telecom DMS-100 switch. For a Siemens SSC EWSD switch, MLH service must be provisioned as *either voice or data* hunting. MLH service is provided through the *Multi-Line Hunt Group (MLHG)* feature on Northern Telecom DMS-100 switches, and through the *Series Completion* feature on the AT&T 5ESS and Siemens SSC EWSD switches.

NOTE:

The MLHG feature on the AT&T 5ESS and Siemens SSC EWSD switches is **not** recommended for use with the MERLIN LEGEND system.

MLH service may be configured in either a linear or circular pattern. Current testing of the MERLIN LEGEND system with the CO switches supports linear hunting on an AT&T 5ESS switch, and circular hunting on the Northern Telecom DMS-100 and Siemens SSC EWSD switches. Other configurations are possible, but they are not guaranteed to work with the MERLIN LEGEND system.

The Service Profile consists of the following:

- A Service Profile Identifier (SPID), which is a unique identifier used by the CO to associate an ISDN terminal with a Service Profile.
- A Directory Number (DN) for each BRI line B-channel. This DN is usually the local phone number that was assigned by the service provider.

If MLH service *is not* subscribed, only one call to a particular DN will be accepted at any given time, and any station with the line appearance of the BRI line will alert. If MLH *is* subscribed, the CO will automatically hunt for the next available B-channel within the hunt group and deliver multiple calls to the same DN. If all B-channels are in use, subsequent calls to the same DN will receive standard CO treatment (such as busy tone).

- Optional features:
 - Calling Party Number/Billing Number (CPN/BN) can also be ordered at subscription time.

The local telephone company normally provides two SPIDs and DNs for each BRI line, also called a Digital Subscriber Line (DSL), ordered. The SPID consists of a string of digits 0 through 9 not more than 20 digits in length. The DN consists of a string of digits 0 through 9 not more than 10 digits in length. Each DSL will use two lines on Form 3i, Incoming Trunks: BRI Options (800 NI-BRI Module).

Planning Form Instructions

1. Transfer the following information from 2c, System Numbering—Trunk Jacks to Form 3i, Incoming Trunks: BRI Options (800 NI-BRI Module):
 - Write the logical ID in the “Logical ID” column. Skip a line between each entry.
 - Write the line number in the “Line Number” column.

NOTE:

Refer to the information provided by the local telephone company to enter the information below.

2. Write the two DNs for each BRI line in the “Directory Number” column.
3. Write the two SPIDs assigned to each BRI line in the “Service Profile Identifier” column.

Refer to the NI-1 BRI Planner form for the information needed to complete the next sections.

4. Indicate the Service Configuration of the Central Office switch:
 - If configured with IOC package “S”, place a check in the IOC “S” column under the “Service Configuration” heading.
 - If configured with MLH service, indicate the type of hunt group provisioned by entering a **V** (voice only hunt group), **D** (data only hunt group), or **V/D** (voice/data hunt group) in either the “MLHG” or “Series Comp.” column under the “Service Configuration” heading as appropriate.

NOTES:

1. IOC package “S” is available on the AT&T 5ESS, Northern Telecom DMS-100, and Siemens SSC EWSD switches.
2. If configured with MLH service, the MLHG feature must be used if the CO is a Northern Telecom DMS-100 switch. The Series Completion feature must be used if the CO is an AT&T 5ESS or Siemens SSC EWSD switch.
3. The MERLIN LEGEND system does not support Voice/Data hunt groups with the Siemens SSC EWSD central office switch.

5. If configured with MLH (using either the MLHG or Series Completion feature), indicate whether the hunt pattern is linear or circular by placing a check in the appropriate column under the "Hunt Pattern" heading.
6. Indicate the features available on each BRI line:
 - If CPN/BN is available, place a check in the "CPN/BN" column as appropriate.

Clock Synchronization

If the system includes both 800 NI-BRI and 100D modules, clock synchronization planning should be completed at the same time. There is only one primary/secondary/tertiary clock for both 800 NI-BRI modules and 100D modules, with the same system programming screens used for both types.

Plan your clock source administration to minimize the need for clock switching, which is known to cause noise on active calls.

The primary, secondary and tertiary clock sources, all three of which should be administered if possible, should be set in the following order:

1. The loop clock sources on BRI ports with DSLs in service. If at all possible, all three clock sources should be on the same 800 NI-BRI module.
2. The loop clock source on any 100D module connected to the CO and in service.
3. The loop clock source on any 100D module in T1 mode operating in a tie-trunk configuration.
4. The local clock source on any 100D module.

If no administration has been performed, upon Frigid Start (system start-up), the first 100D or NI-1 BRI port that is in service will be the default primary loop clock source.

NOTE:

Extra BRI DSLs which are not in service should never be administered as clock sources.

Planning Form Instructions

Refer to Form 1, System Planning, Control Unit Diagram. Complete the following information on Form 3i, Incoming Trunks: BRI Options (800 NI-BRI Module), page 2:

1. To keep the factory setting (the first slot and port found in the system provides synchronization for the system) or if assigning a different module to provide primary clock synchronization:

- Enter the slot and/or DSL number (BRI only) under "Primary Clock Synchronization."
- Under the "Source" subheading, check "Loop" to indicate that the system uses the clock of the far-end connection (factory setting) or "Local" to indicate the clock is free-running (100D modules only).

NOTE:

The only option for a 800 NI-BRI module is loop, which is automatically assigned and is not administrable.

2. If assigning secondary or tertiary backup synchronization:

- Enter the slot and DSL number (BRI only) under "Secondary Clock Synchronization" and/or "Tertiary Clock Synchronization."
- Under the "Source" subheading in each column, check "Loop" to indicate that the system uses the clock of the far-end connection (factory setting) or "Local" to indicate the clock is free-running (100D modules only).

NOTE:

The only option for a 800 NI-BRI module is loop, which is automatically assigned and is not administrable.

Timers

Timers ensure that the system takes the appropriate corrective action when the expected response is not received from the network during normal operation.



CAUTION:

Since incorrect settings can hinder the operation of BRI facilities, consult with an AT&T representative or authorized dealer before making changes. The factory-set thresholds are standard settings and should rarely be changed.

The timers, descriptions, factory settings, and allowable thresholds are shown in Table 3-5.

Planning Form Instructions

On Form 3i, Incoming Trunks: BRI Options (800 NI-BRI Module), under the "Timers and Counters" heading on page 2:

1. For each timer:
 - To keep the factory setting, check the first box under the timer name.
 - To change the factory setting, check the second box under the timer name and write the new threshold in the space provided.

Table 3-5. NI-1 BRI Timers

Name	Description	Factory Setting	Allowable Threshold
T200	The minimum time which Layer 2 must wait for an acknowledgment of a link establishment frame, an information frame, or a polling supervisory frame, before initiating retransmission procedures.	1,000 ms	500–5,000 ms in increments of 500 ms
T203	The maximum time for which the Layer 2 link can remain inactive.	33 seconds	10–255 seconds in increments of 1 second
T303	The delay in CO response after the system has sent a SETUP message to initiate an outgoing call.	4 seconds	2–10 seconds in increments of 1 second
T305	The delay in response from the CO after the system has initiated a DISConnect message for call clearing.	30 seconds	2–60 seconds in increments of 1 second
T308	The delay in response from the CO after the system has sent a RELease message for call clearing.	4 seconds	2–10 seconds in increments of 1 second

Compensating for Slow Dial Tone (International)

If this system is being installed *outside of the U.S.*, problems can arise because of slow dial tone from local telephone companies due to the limitations of their switching equipment. If this is the case, be aware of the following:

- Users should be instructed to wait for dial tone before they dial. (Due to changes made to internal timers, the system will allow the delay.)
- The following features cannot be used:
 - Automatic Route Selection
 - Remote Call Forwarding
 - Remote Access (outgoing)
 - Tie trunks (configuration-dependent)
 - Delay option on rotary lines
 - Autodial, Last Number Dial, Saved Number Dial, and Callback queue

Also, the slow dial tone may cause problems with transferring a call, joining a call, and end-to-end signaling.

- Additional touch-tone receiver (TTR) boards may be needed for the system. The number of TTRs can be increased by adding 400 GS/LS or 016 modules, each of which provides four TTRs or by adding 008 OPT, 012, 800 GS/LS-ID, or 800 DID modules, each of which provides two TTRs.

To determine the number of TTRs needed, perform a traffic study on the number of outgoing single-line telephone calls/busy hour, and the number of incoming calls/busy hour routed to applications such as MERLIN MAIL. Then use Table 3-5 to determine the number of TTRs required.

Table 3-6. Total Number of TTRs Required

Calls per Hour	Dial-Tone Delay					
	0 sec	15 sec	30 sec	45 sec	60 sec	75 sec
110	4	4	6	6	8	8
180	6	6	8	10	10	10
350	8	10	10	10	14	14
420	8	10	12	14	14	16
610	10	12	14	16	18	20
710	10	14	16	18	20	22

Assigning Lines/Trunks

This section contains instructions for assigning lines/trunks to telephones and Direct-Line Consoles.

NOTE:

To assign lines/trunks to data-only stations, follow the instructions in Chapter 5, "Data Communications."

Forms Needed

- Form 2a, System Numbering: Extension Jacks
- Form 2b, System Numbering: Digital Adjuncts
- Use the following forms as appropriate for telephones and consoles in the system. Make one copy of the appropriate form for each extension.
 - Form 4b, Analog Multiline Telephone
 - Form 4d, MLX Telephone
 - Form 4e, MFM Adjunct: MLX Telephone
 - Form 4f, Tip/Ring Equipment
 - Form 5a, Direct-Line Console (DLC): Analog
 - Form 5b, Direct-Line Console (DLC): Digital
 - Form 5c, MFM Adjunct: DLC

Planning Form Instructions

1. On page 1 of Forms 4b, 4d, 5a, and 5b, transfer the following user information from Form 2a, System Numbering: Extension Jacks to each copy of each of these telephone forms:
 - a. Write the logical ID in the Logical ID space.
 - b. Write the extension number in the Extension No. space.
 - c. Write the name of the person or the location of the equipment in the Person or Location space.

2. For any **voice/voice** or **voice/data** entries in the Person or Location column of Form 2a, indicate the type of extension jack pairs under the Extension Jack Pair heading on Forms 4b and 5a by doing *one* of the following:
 - Check the Voice Announce to Busy (voice/voice) box and enter the logical ID and extension number under the Even-numbered jack heading.
 - Check the Simultaneous Voice and Data (voice/data) box and enter the logical ID and extension number under the Even-numbered jack heading.
3. For any adjuncts connected to an MLX telephone using an MFM, fill in the following user information from Form 2b, System Numbering: Digital Adjuncts on Forms 4e and 5c in the Connected to MLX extension No. space:
 - a. Write the extension number in the Extension No. space.
 - b. Write the name of the person or the location of the equipment in the Person or Location space.
4. Identify the equipment at each extension (see the floor plan):
 - a. Check the box that describes the telephone, console model, or type of tip/ring equipment.
 - b. Check the box under Adjuncts that describes the adjuncts at the extension. (Checking the Data terminal box is informational only.)

Assigning Telephone Buttons

This section contains instructions for assigning buttons to:

- Telephones in Hybrid/PBX mode
- Telephones in Key and Behind Switch mode
- DLCs

Forms Needed

- Form 4b, Analog Multiline Telephone
- Form 4d, MLX Telephone
- Form 4e, MFM Adjunct: MLX Telephone
- Form 4f, Tip/Ring Equipment
- Form 5a, Direct-Line Console (DLC): Analog
- Form 5b, Direct-Line Console (DLC): Digital
- Form 5c, MFM Adjunct: DLC

Telephones in Hybrid/PBX Mode

This section contains instructions for assigning the following kinds of buttons to telephones or to adjuncts connected to an MLX telephone using an MFM (excluding QCC operator positions):

- System Access Ring (**SA Ring**) button
- System Access Voice (**SA Voice**) button
- System Access Originate Only (**SA Orig Only**) Button
- Shared System Access (**SSA**) button
- Personal line button
- **Pool** button
- Loudspeaker Paging button

The system automatically assigns certain kinds of line buttons depending on the type of equipment. For nonoperator multiline telephones, the system assigns **SA Ring**, **SA Voice**, and **SA Orig Only** buttons (see Figures 3–2 and 3–3).

For detailed information about telephones and their buttons, see the *Equipment and Operations Reference*.

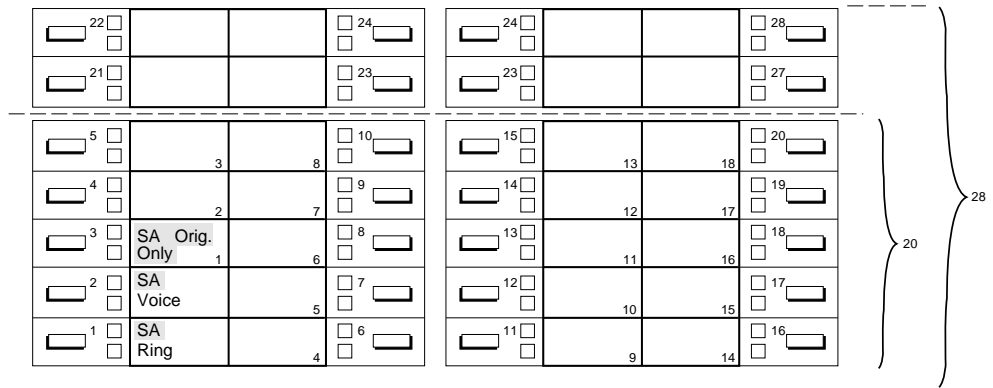

Figure 3–2. Factory-Set Assignment, MLX Telephones (Hybrid/PBX Mode)

Although equipment such as single-line telephones, answering machines, and fax machines do not have buttons, the system treats these as multiline telephones with 34 buttons.

The system assigns one **SA Ring**, one **SA Voice**, and one **SA Orig Only** button to every adjunct connected through an MFM to an MLX telephone. For equipment connected to an 012, 016, or 008 OPT module, the system assigns two **SA Ring** buttons and one **SA Orig Only** button.

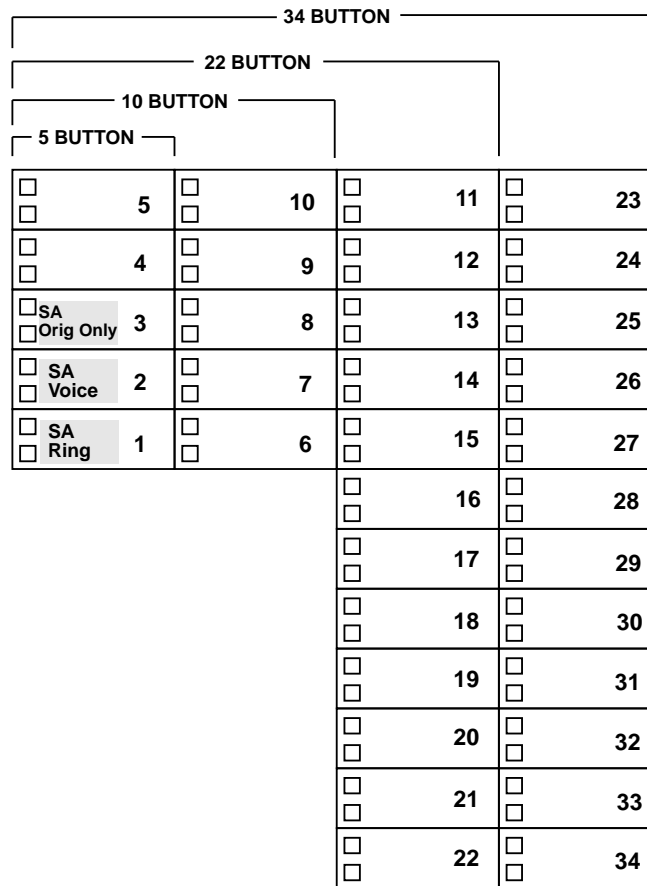

Figure 3-3. Factory-Set Assignment, Analog Multiline Telephones (Hybrid/PBX Mode)

Guidelines for Button Assignments

Use the following guidelines for assigning buttons to telephones or to adjuncts connected to an MLX telephone.

NOTE:

When assigning buttons to telephones or adjuncts, keep in mind that BRI lines are not automatically assigned to telephones or DLCs.

For multiline telephone users:

- You can assign **SA Voice**, **SA Ring**, and **SA Orig Only** buttons and up to 27 **SSA/SA** buttons to each telephone. However, use the factory setting of 3 to ensure that when each user is busy on a call at least one additional button is available to receive a call and another is available to make a call. This leaves the rest of the buttons on multiline telephones free for customizing.

NOTE:

On a DLC, there can be 10 System Access buttons (including **SA Orig Only**), but no **SSA** buttons. On a QCC, no buttons can be programmed, however, if the QCC Voice Announce feature has been enabled, the **Call5** button becomes a **VA** (Voice Announce) button.

- If you plan to use Automatic Route Selection (ARS), consider keeping the factory-set button assignments. Since ARS picks the appropriate route, there is no need for **Pool** buttons.
- Consider assigning **SSA** buttons to small groups of users who need to answer and distribute each other's calls easily or to join conversations. Each **SSA** button you assign corresponds to an **SA Ring** or **SA Voice** button on another telephone. Therefore, to provide complete coverage within the group, you must be sure that each **SA Ring** and **SA Voice** button assigned to a telephone is also assigned to other members of the group. Each **SA Ring** or **SA Voice** button on a telephone can be assigned as an **SSA** button on up to 16 other telephones.
- Assign a **Pool** button when a specific trunk pool (for example, BRI, WATS or FX) is used frequently. Also consider assigning **Pool** buttons if you do not plan to use ARS and the system includes only one or two pools.
- Assign personal line buttons when an exclusive private number is needed, for example, for a company executive. Any line/trunk connected to the system can be used as a personal line as long as it is not in a trunk pool.

For single-line telephones, answering machines, fax machines, or any other device connected to an 012, 016, or 008 OPT module:

- The settings for **SA** buttons can be changed (see below); however, factory settings should be adequate to meet most user needs, since **SA** buttons can be used to make and receive both inside and outside calls.

- Single-line telephones cannot have additional **SA** or **SSA** buttons. However, single-line telephones connected through an 012, 016, or 008 OPT module can have **SA** buttons removed from them. Removing all but one **SA** button from Single-line telephones will disable features such as Transfer, Conference, and any other feature that requires more than one **SA** button.
- If you want the extension to receive outside calls on a specific line/trunk, assign a personal line button; if you want the extensions to receive outside calls on a line/trunk included in a pool, assign a **Pool** button. See *System Programming* for instructions.

For adjuncts connected using an MFM, it is recommended that you change the Button 2 assignment to **SA Orig Only** and remove the Button 3 assignment.

Planning Form Instructions

1. Using the guidelines above, select the types of buttons to assign to each telephone.
2. Complete the Button Diagram page of each copy of Forms 4b, 4c, 4d, 4e, and 4f.

NOTE:

The button diagrams for DLCs (Forms 5a and 5b) will be completed later.

- a. On buttons 1 through 27, indicate the types of System Access buttons by circling **SA** for **SA Voice**, **SA Ring**, or **SA Orig Only**, and writing **Ring** or **Voice** or **SA Orig Only** buttons and writing **Shared SA**, **Pool**, or **Personal line**. Then do the following as appropriate:
 - For an **SSA** button, include the number of the extension with the associated **SA** button (see Form 2a), and the button number on that telephone.
 - For a **Pool** button, include the pool's extension number (see Form 2c).
 - For a personal line button, include the telephone number and record the line/trunk numbers (see Form 2c).
 - Indicate whether all but one **SA** button will be removed from Single-line telephones on Form 4f.
- b. Assign Loudspeaker Page buttons by selecting the button and writing **Page** on it.

If the system includes one or more DLCs, proceed to "Direct-Line Consoles" later in this section. Otherwise, proceed to Chapter 4, "Features," to record feature assignments on these forms for each extension.

Telephones in Key and Behind Switch Mode

The line buttons you assign to the telephones or the adjuncts connected through an MLX telephone using an MFM are the following:

- Intercom Ring (**ICOM Ring**) button
- Intercom Voice (**ICOM Voice**) button
- Intercom Originate Only (**ICOM Orig Only**) button
- Loudspeaker Paging button
- Personal line button (Key mode only)
- Prime line button (Behind Switch mode only)

NOTE:

In the Behind Switch operating mode, the system automatically assigns two prime lines to each port on an MLX module—one for the MLX telephone and one for the device connected to the Multi-Function Module (MFM). If an MFM is not connected to an MLX telephone or the MLX port is not used, the prime line for the MFM can be removed. The prime line can then be assigned to other users.

Factory Assignments

The system automatically assigns certain kinds of line buttons depending on the type of equipment and the mode of operation:

- In Key mode, the system assigns an **ICOM Ring** button and an **ICOM Voice** button; the first eight outside lines connected to the control unit are assigned to each nonoperator multiline telephone beginning with Button 3.
- In the Behind Switch mode, the system assigns an **ICOM Voice** button, an **ICOM Ring** button, and one prime line button (Button 3) to every nonoperator multiline telephone.
- For either mode, the line/trunk assignment is the same for both analog multiline and MLX telephones.

Figure 3-4 illustrates the factory-set button assignments for MLX telephones and Figure 3-5 illustrates the factory-set button assignments for analog multiline telephones.

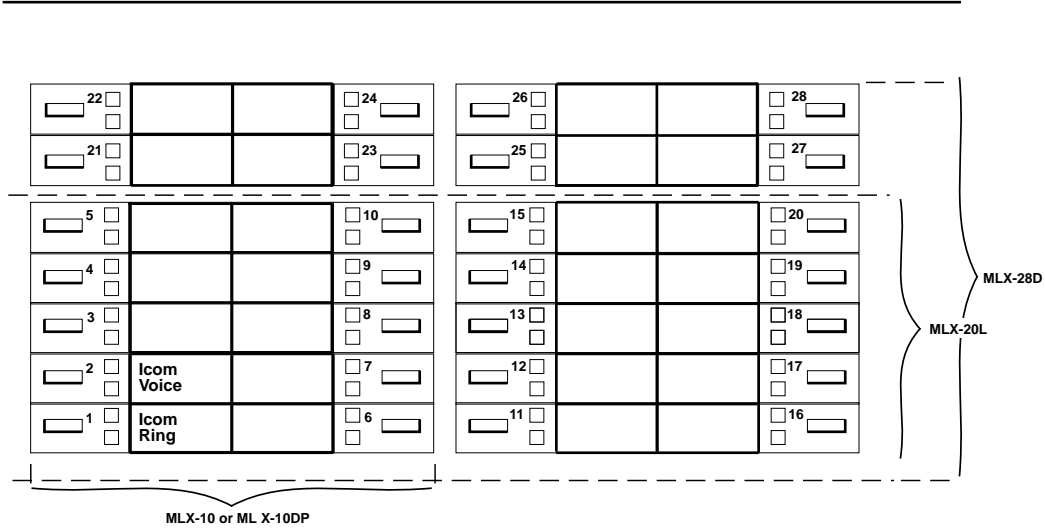

Figure 3-4. Factory-Set Assignment, MLX Telephones (Key and Behind Switch Modes)

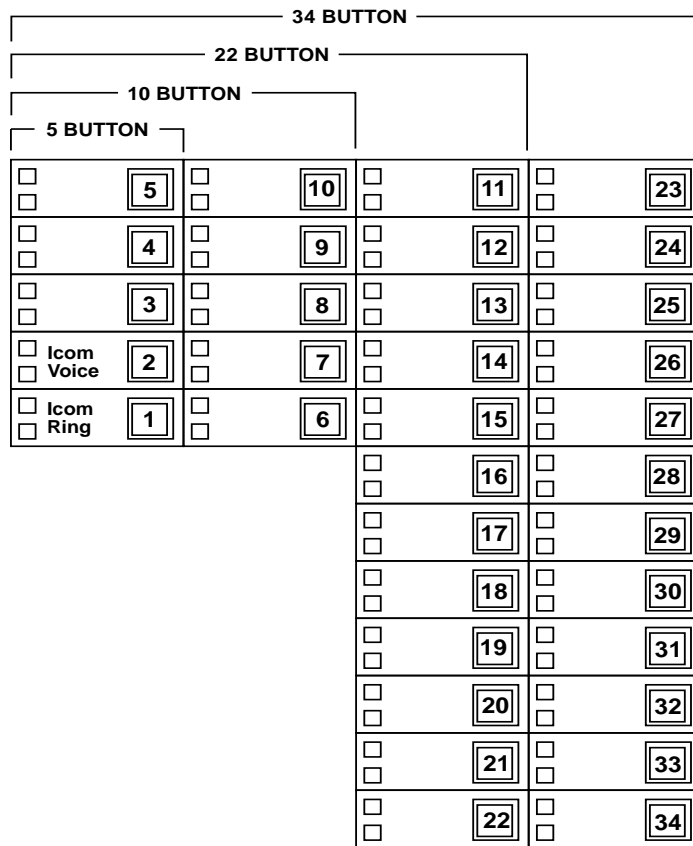

Figure 3-5. Factory-Set Assignment, Analog Multiline Telephones (Key and Behind Switch Modes)

Although equipment such as single-line telephones, answering machines, and fax machines do not have buttons, the system treats these as multiline telephones with 34 buttons. In both Key and Behind Switch modes, the system assigns no outside lines to this type of equipment. The system assigns two **ICOM Ring** buttons to every adjunct connected through an MFM to an MLX multiline telephone and to equipment connected to an 012, 016, or 008 OPT module.

Guidelines for Button Assignments

This section contains guidelines for assigning buttons in Key or Behind Switch mode.

Key Mode

Use the following guidelines to assign buttons for a system in Key mode.

NOTE:

When assigning buttons in Key mode, keep in mind that BRI lines are not automatically assigned to telephones or DLCs.

For Key mode with multiline telephone users:

- You can assign **ICOM Voice**, **ICOM Ring**, or **ICOM Orig Only** buttons to each extension.
- Assign additional **ICOM Ring**, **ICOM Voice**, or an **ICOM Orig Only** button for people who frequently receive or make transferred calls. The **ICOM Orig Only** button ensures that if all intercom buttons are busy, at least one is still available to make a call or to transfer the current call.
- Assign additional outside lines, including special-purpose lines such as WATS or FX.
- Remove or rearrange the eight factory-set line assignments, if desired.
- For all types of telephones for which you want the extension user to receive outside calls on a specific line, assign a personal line to a button on the telephone or adjunct.
- Consider assigning a Loudspeaker Paging button to make announcements over an optional loudspeaker connected to the control unit. To make an announcement, users press the button and speak into the handset. They do not need to dial the extension of the loudspeaker paging system.

For Key mode with single-line telephone users, answering machines, fax machines, or any other device connected to an 012, 016, or 008 OPT module or an MFM:

- You can assign a combination of up to 10 **ICOM Voice**, **ICOM Ring**, or **ICOM Orig Only** buttons to each extension. (At least one intercom button must be assigned to each single-line telephone or adjunct connected to an MLX telephone using an MFM.)
- If you want the extension user to receive outside calls on a specific line, assign a personal line to a button on the telephone or adjunct. The extension user is automatically connected to the intercom line when the receiver is lifted, and the user can select an outside line by dialing the dial-out code (usually a **7**).

Behind Switch Mode

Use the following guidelines to assign buttons for a system in Behind Switch mode.

NOTE:

For adjuncts connected using an MFM, you should change the Button 2 assignment to **ICOM Orig Only** and remove the Button 3 assignment.

For Behind Switch mode with multiline telephones:

- You can assign additional lines and any outside lines connected directly to the control unit, including special-purpose lines.
- If a loudspeaker paging system is to be connected to the control unit, include a programmed Loudspeaker Paging button to make announcements over the loudspeaker system. To make an announcement, users press the button and speak into the handset. They do not need to dial the extension of the loudspeaker paging system.

For Behind Switch mode with single-line telephones, answering machines, fax machines, or any other devices connected to an 012, 016, or 008 OPT module or an MFM, you can assign additional lines and any outside lines connected directly to the control unit, including special-purpose lines.

Planning Form Instructions

1. Using the guidelines above for Key and Behind Switch modes, select the types of buttons to assign to each telephone.
2. Complete the Button Diagram page of each copy of Forms 4b, 4d, 4e, 4f, and 5c by doing *one* of the following:
 - To keep the factory-set assignments, proceed to Step 3.
 - To change the factory-set assignments, skip to Step 4.
3. To keep the factory-set assignments:
 - For multiline telephones in Key mode, fill in the telephone number on Buttons 3 through 10. Record the line numbers (see Form 2c).
 - For multiline telephones in Behind Switch mode, fill in the extension number of the prime line on Button 3.

4. To change the factory-set assignments:
 - a. On Buttons 1 through 10, indicate the type of intercom button by circling **ICOM** for **ICOM Voice**, **ICOM Ring**, or **ICOM Orig Only**, and writing **Ring**, **Voice**, or **Orig Only**.
 - b. Fill in the telephone numbers (or prime-line extension numbers) to be assigned or changed. Start with Button 3 and record the line numbers on the diagram (see Form 3b).
 - c. Assign programmed Loudspeaker Paging buttons by selecting the button and writing **Page** on it.

Direct-Line Consoles

Use these instructions only if the system has one or more DLCs. Otherwise, proceed to Chapter 4, "Features," to record feature assignments on the forms for each extension.

NOTE:

For more information on DLCs, see the *Feature Reference*.

The number of line, Direct Station Selector (DSS), and programmed feature buttons assigned to a DLC depends on the type of telephone and the number of lines/trunks connected to the system. The factory setting for DLCs is that, in addition to an **SA Voice** and an **SA Ring** button or **ICOM** buttons, as many lines/trunks as possible are assigned to each console. Each line/trunk appears on a separate button, which means that the number of lines/trunks assigned is limited to the number of buttons on the console (up to a maximum of 32 buttons on the 34-button analog DLC).

If a DSS is present, the system assigns a DSS button for each extension number associated with an extension and special-feature buttons that are used by the DLC operator for call-handling functions.

Figures 3–6 and 3–7 show initial line/trunk and feature assignments for MLX and analog DLC consoles. Refer to the appropriate figure as you select line/trunk assignments for DLCs.

NOTE:

System Access buttons appear on DLCs in Hybrid/PBX mode. Intercom buttons appear on DLCs in Key or Behind Switch mode.

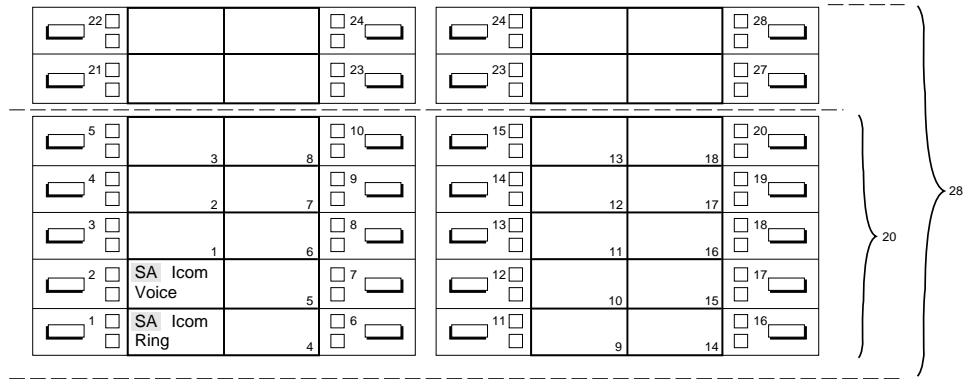

Figure 3-6. MLX Direct-Line Console

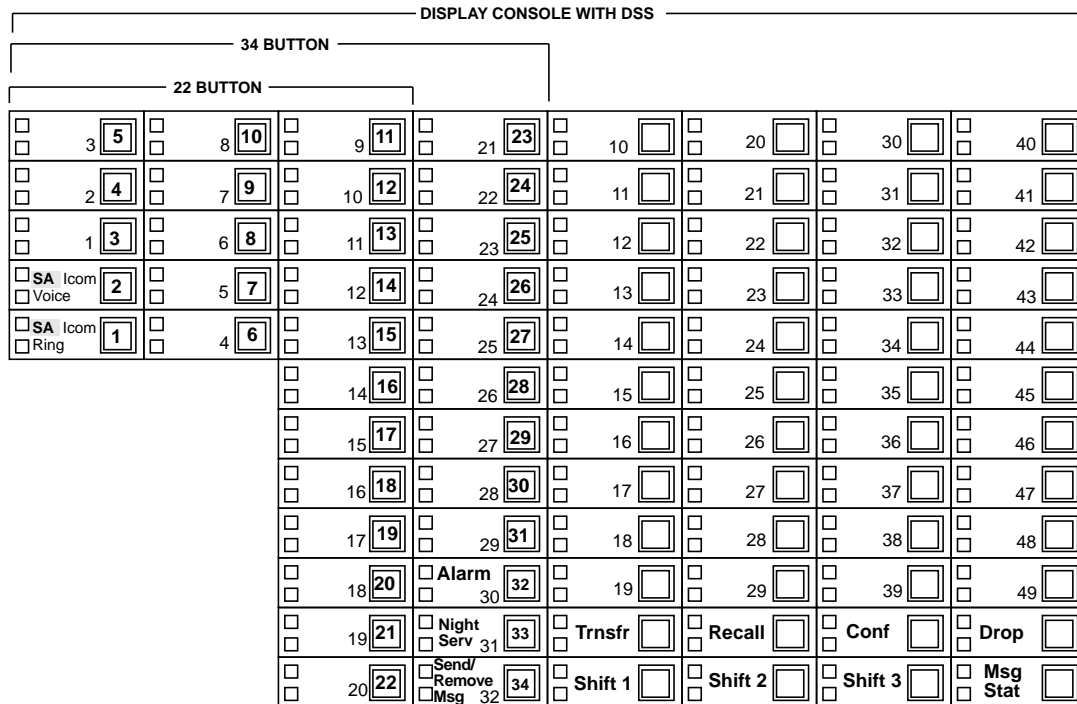

Figure 3-7. Analog Direct-Line Console

NOTE:

If the system has more than 29 lines, Alarm, Night Service, and Send/Remove Message are replaced with lines 30, 31, and 32.

The system assigns lines/trunks to buttons on DLCs in the order in which the lines/trunks are connected to the control unit. You can change the factory-set assignments by removing, adding, or changing the order in which lines/trunks are assigned to buttons for each DLC operator.

If the system has more than the number of factory-assigned lines/trunks to operator consoles, be sure to change the line/trunk assignment so that all lines/trunks you want answered by a DLC operator appear on at least one operator position.

Decide which lines/trunks should appear on each DLC operator console based on each operator's call-handling responsibilities. All operators may not need the same assignments. DLC operators who are responsible for answering calls for specific groups usually need only the lines/trunks used by group members.

If the system includes a loudspeaker paging system, consider assigning a programmed Loudspeaker Paging button to DLC positions for one-touch access to the paging equipment. If the system has fewer than 30 lines, the operator-only features (Alarm, Night Service, and Send/Remove Messages) are factory-assigned as shown in Figure 3–6. The factory assignments can be changed through centralized telephone programming or by a DLC operator.

Planning Form Instructions

Complete the Button Diagram page on each copy of Form 5a and Form 5b:

1. For the Ring and Voice buttons, circle SA or Icom.
2. Write the telephone number of the line/trunk you want to assign in the space on the Button Diagram page. Record each line/trunk number (see Form 2c).
3. Assign **Alarm**, **Night Service**, or **Send/Remove Message** buttons by labeling the appropriate button **Alarm**, **Nite Svc**, or **Snd/Rem Msg**.
4. Assign programmed Loudspeaker Paging buttons by selecting the button and writing **Page** on it.

Proceed to Chapter 4, "Features," to complete the remaining sections of these forms.

Features

4

Contents

Telephone and Extension Features	4-2
■ Queued Call Console (Hybrid/PBX Only)	4-3
■ Pool Dial-Out Code Restriction (Hybrid/PBX Only)	4-4
■ Calling Restrictions	4-4
■ Forced Account Code Entry	4-5
■ Microphone Operation	4-5
■ Remote Call Forwarding	4-6
■ Fax Message-Waiting Receiver	4-7
■ Trunk-to-Trunk Transfer	4-8
■ Extension Copy	4-8
Operator Features	4-12
■ Direct-Line Console	4-12
Operator Hold Timer	4-12
DLC Automatic Hold	4-12
■ Queued Call Console (Hybrid/PBX Mode Only)	4-13
Hold Return	4-13
Automatic Hold or Release	4-14
Queue Over Threshold	4-14
Elevate Priority	4-15
Calls-in-Queue Alert	4-15
Message Center	4-16
Directed Call Completion	4-16
Return Ring	4-17
Position-Busy Backup	4-17
Operator Hold Timer	4-17
Call Types	4-18
Voice Announce	4-18

Contents

■ Direct Station Selector	4-19
Page Buttons	4-19
Park Zones	4-19
Group-Assigned Features	4-20
■ Call Pickup Groups	4-21
■ Group Paging	4-21
■ Coverage	4-22
Individual Coverage	4-23
Group Coverage	4-24
■ Group Calling	4-25
Calling Group Options	4-28
System Features	4-31
■ Transfer Options	4-32
■ Camp-On Return Time	4-33
■ Call Park Return Time	4-33
■ Automatic Callback	4-34
■ Extension Status	4-34
■ SMDR (Station Message Detail Recording)	4-35
■ Inside Dial Tone	4-36
■ Reminder Service Cancel	4-36
■ Calls to Unassigned Extensions	4-36
■ Recall Timer	4-37
■ Rotary	4-38
■ Allowed Lists	4-38
■ Disallowed Lists	4-40
■ Call Restriction Summary	4-42
■ Night Service	4-42
Night Service with Group Assignment	4-42
Night Service with Outward Restriction	4-43
Night Service with Time Set	4-44
■ Labeling	4-45
Posted Message	4-45
System Speed Dial	4-46
■ Automatic Route Selection (Hybrid/PBX Only)	4-47
ARS Worksheet	4-47
Automatic Route Selection Tables	4-51
Subpatterns	4-55

The system offers many optional features. This chapter contains instructions for assigning features in the following categories:

- **Telephone and Extension Features.** Individual telephones, consoles, or adjuncts are assigned these features. Some features may be assigned to other equipment at an extension.
- **Operator Features.** All operator consoles are assigned these features.
- **Group-Assigned Features.** These features are used by functional groups of users (such as separate departments).
- **System Features.** All or most of the users on the system use these features.

Detailed information about all features (including the considerations, constraints, and feature interactions that may impact their use) is contained in the *Feature Reference*. You should be familiar with this information before you attempt to perform the procedures in this chapter.

Since these features are optional, you can simply skip those sections that do not apply to the system.

Each individual telephone form is a complete record for that specific telephone for planning, programming, and subsequent reference by the system manager. Some features noted on the individual telephone forms are not described in this book, for example, Abbreviated Ring, Call Waiting, and Automatic Line Selection. For more information about these features, see the *Feature Reference*.

NOTE:

Except for some telephone-specific features, for example, microphone operation, many of the features described in this chapter can be assigned to other equipment, such as a data terminal or fax machine. Therefore, throughout this chapter, the more general term “extension” is often used instead of or in addition to “telephone.”

Telephone and Extension Features

This section contains instructions for assigning some optional features to extensions. These features may be used by both system operators and general users:

- Pool Dial-Out Code Restriction (Hybrid/PBX mode only)
- Calling restrictions
- Forced Account Code Entry
- Microphone operation
- Remote Call Forwarding
- Fax Message-Waiting Receiver and Threshold
- Trunk-to-Trunk Transfer

The system programmer assigns these features.

There are additional extension features noted on the forms but not covered in this book. Individuals normally program these features at their telephones, although the system manager may also program these features using centralized telephone programming. You may, however, want to complete the information on the forms so they can serve as a complete summary of features for each extension. Detailed information about these and all features is contained in the *Feature Reference*. Instructions for using centralized telephone programming are in *System Programming*. For users who want to program features on their own telephones, information and procedures are contained in the user and operator guides.

You may choose the Extension Copy feature to create a template that can then be copied to other like extensions whose users require the same features. This feature is also described in this section.

Forms Needed

- Form 2a, System Numbering: Extension Jacks
- Form 4b, Analog Multiline Telephone
- Form 4d, MLX Telephone
- Form 4e, MFM Adjunct: MLX Telephone
- Form 4f, Tip/Ring Equipment
- Form 5a, Direct-Line Console (DLC): Analog
- Form 5b, Direct-Line Console (DLC): Digital
- Form 5c, MFM Adjunct: DLC
- Form 5d, Queued Call Console (QCC)
- Form 6b, Optional Extension Features
- Form 6g, Call Restriction Assignments and Lists
- Form 6h, Authorization Codes
- Form 6i, Pool Dial-Out Code Restrictions
- Floor plan

Queued Call Console (Hybrid/PBX Only)

Use these instructions if the system includes one or more QCCs. Otherwise, skip to the next section, "Pool Dial-Out Code Restriction (Hybrid/PBX Only)."

Planning Form Instructions

1. Transfer the user information from Form 2a, System Numbering: Extension Jacks to each copy of Form 5d by filling in the Logical ID, Extension No., and Person or Location spaces. Use the Button Diagram on Form 5d, as a guide for labeling the operator console buttons. You cannot change the button assignments shown. However, if the QCC Voice Announce feature is enabled, the **Call 5** button becomes a **VA** (Voice Announce) button. Refer to the "Operator Features" section later in this chapter.
2. Check the box under the Adjuncts heading that applies to the equipment at the extension (see the floor plan).
3. Under Message Center Operator, check No if the QCC will not be a message center or Yes if it will be a message center.

Proceed to the next section, "Pool Dial-Out Code Restriction (Hybrid/PBX Only)."

Pool Dial-Out Code Restriction (Hybrid/PBX Only)

This section contains instructions to tailor the use of dial-out access codes by restricting extensions from making calls on specific trunk pools (for example, those consisting of special-purpose lines/trunks such as WATS or FX) or to reserve trunk pools for data communications only.

Planning Form Instructions

Use Form 6i to identify those extensions that are restricted from using some dial-out access codes. The factory setting is for *all* extensions to be restricted from using *all* dial-out access codes. This form only identifies extensions that are to remain restricted. Extensions that are not listed on this form must have their restrictions removed through system administration.

Calling Restrictions

This section contains instructions to restrict selected extensions from making outside calls—for example, for telephones in a reception area and to control toll-call abuse—but still allow local and intercom calls.



SECURITY ALERT:

Calling restrictions [for example, Disallowed Lists, toll restriction, Facility Restriction (FRL) Levels] should be programmed, as appropriate, to minimize toll fraud abuse. Refer to the “Calling Restrictions” section in the Feature Reference for additional information on programming calling restrictions.

Planning Form Instructions

If these restrictions are too limited, use “Allowed Lists” and “Disallowed Lists,” as described later in this chapter.

Use Form 6h to identify Authorization Codes for use by the users of certain extensions. After Form 6h is filled in, remove it from the forms set and keep it in a secure place.

Use Form 6g, Call Restriction Assignments and Lists, to identify the extensions with calling restriction assignments. List the extensions with calling restrictions in the Ext. No. column and the type of restriction in the Restriction Type column. The factory setting is Restricted.

NOTE:

Setting this option to Outward Restrict or Toll Restrict does *not* allow reliable toll restriction on telephone company lines/trunks that do not require 1 or 0 for toll calls. The Toll Type setting of 1 or 0 allows the system to classify calls as either local or toll, based on the number a user dials. Dialing a prefix depends on local telephone company requirements and the type of trunk being used. The system must be programmed to designate whether or not to restrict users from dialing calls to certain areas. The Toll Type feature does *not* apply to tie trunks or DID trunks.

To restrict the extension from making outside calls so only intercom calls can be made, check the Outward Restriction column.

To restrict the extension from making toll calls so only intercom and local calls can be made, check the Toll Restriction column.

Forced Account Code Entry

This section contains instructions for setting up the system to associate calls with corresponding accounts, clients, or projects for billing and accounting purposes.

Planning Form Instructions

Use Form 6b to identify extensions requiring forced Account Code Entry. Under the Forced Account Code Entry heading on Form 6b, do *one* of the following:

- To allow users to make calls without entering an account code, check the No (factory setting) box.
- To require users to enter an account code, check the Yes box.

Microphone Operation

This section contains instructions to disable the microphones on MLX telephones when they are used in areas where use of the speakerphone is disruptive.

NOTE:

The microphones on analog multiline telephones cannot be disabled.

Planning Form Instructions

Under the Microphone heading on Form 6b, do *one* of the following:

- To allow speakerphone use (factory setting), check Enable.
- To prevent speakerphone use, check Disable.

Remote Call Forwarding

This section contains instructions to allow users to forward calls to outside numbers, and to allow users to “screen” their calls through use of the Forwarding Delay option. With the Forwarding Delay option activated, incoming calls ring at the called station a specified number of times (from 1 to 9 rings) before the call is forwarded.



SECURITY ALERT:

Remote Call Forwarding can only be used securely when used on ground-start line/trunks or loop-start lines/trunks with “reliable disconnect” (sometimes referred to as forward disconnect or disconnect supervision). Toll fraud can occur when loop-start lines/trunks are used with unreliable disconnect. If the calling party stays on the line after the called party hangs up, the central office will return a dial tone at the conclusion of the call enabling the caller to place another call as if it were being placed from your company.

Remote Call Forwarding and the Forwarding Delay option are programmed for each extension. Assign these features to selected extensions, for example, for people who often work away from the office. Remote Call Forwarding cannot be assigned to QCCs. If there is a personal line assigned to a telephone, you can specify that calls on that line be forwarded to an outside number if the extension is the principal user of the personal line.

When a principal user is assigned, calls received on the personal line are also sent to Individual or Group Coverage receivers unless the personal line button is set for No Ring. Calls are not sent to coverage if Remote Call Forwarding is activated.

Planning Form Instructions

1. Under the Remote Call Forwarding heading on Form 6b, do *one* of the following:
 - To prevent users from forwarding calls to outside numbers (factory setting), check the Not Allowed column and proceed to the next section, “Fax Message-Waiting Receiver.”
 - To provide Remote Call Forwarding, check the Allowed column, then proceed to Step 2.
2. If you want a user to be able to forward the incoming calls on a specific line or lines to another number, write the extension number in the spaces provided on Form 6c, Principal User of Personal Line. There can be more than one user (see Form 2c, System Numbering: Line/Trunk Jacks).

3. If Remote Call Forwarding is enabled, do *one* of the following:
 - If you wish to disable the Forwarding Delay option, enter **0** in the Delay (0-9) column under the Remote Call Forwarding heading on Form 6b. This causes incoming calls to be forwarded immediately.
 - If wish to enable the Forwarding Delay option for an extension, enter the number of times an incoming call should ring at the called extension (1–9 rings) before the incoming call is forwarded.

NOTES:

1. If Do Not Disturb (DND) and Forwarding Delay are both active, DND overrides the Forwarding Delay and the call is forwarded immediately.
2. Due to the timing of when the ringing signal is applied to a Single-line telephone, and the interval of that ringing signal, Single-line telephones may appear to have their calls forwarded one ring less than the administered number.

Fax Message-Waiting Receiver

Use these instructions only when the system has fax machines connected directly to the control unit by way of an 008 OPT, 016, or 012 module or connected to an MLX telephone using a Multi-Function Module (MFM). Otherwise, skip to the next section, "Operator Features."

Fax machines cannot use General-Purpose Adapters (GPAs) because they cannot auto dial through the GPA.

This section contains instructions to designate from one to four telephones to receive message-waiting indications when a fax is received on a specific fax machine, and to specify the length of time before the system assumes a fax has arrived and sends the message-waiting indication.

Planning Form Instructions

Use Form 6d to identify up to 16 fax machine extension numbers and up to four receiver extension numbers for each fax number.

The System Notification Threshold setting can be left at the factory default of 10 seconds or be changed and identified on the line at the top of the form for up to 30 seconds.

NOTE:

You will fill in the rest of the optional telephone features later.

Trunk-to-Trunk Transfer

This section contains instructions to allow or disallow trunk-to-trunk transfer at each extension.

Trunk-to-trunk transfer may only be performed on ground-start trunks and loop-start trunks with reliable disconnect.

Trunk-to-trunk transfer may be disabled for a specific extension. Single-line telephones are restricted from completing a trunk-to-trunk transfer.

Planning Form Instructions

Use Form 6b to identify extensions permitted to perform trunk-to-trunk transfers. Under the Trunk-to-Trunk Transfer heading on Form 6b, do *one* of the following:

- To block an extension from completing a trunk-to-trunk transfer, check the No (factory setting) box.
- To allow an extension to complete trunk-to-trunk transfers, check the Yes box.

Extension Copy

The Extension Copy feature enables you to copy an extension's programmed buttons (with some exceptions) to one or more extensions. The features are individually programmed on one extension to create a template that can then be copied to other extensions in the system. You can make additional copies of these forms and have several templates for different groups of users.

Only similar types of extensions can be copied to each other (that is, analog to analog and MLX to MLX) because both extension types have different button layouts. For a system that has both telephone types, you would need at least two templates, one for analog and one for MLX.

NOTE:

A Multi-Function Module (MFM) extension can be copied to or from another MFM extension. An analog DLC extension can only be copied to another analog DLC extension. An MLX DLC extension can only be copied to another MLX DLC extension. Single-line telephones and QCCs *cannot* use the Extension Copy feature.

Table 4–1 contains a list of the features that can be copied and whether the features apply to analog telephones, MLX telephones, or both. Following the table is a list of operator features that can be copied.

Table 4-1. Features That Can Be Copied

Feature	Analog and MLX	Analog Only	MLX Only
Account Code Entry	✓		
Authorization Code	✓		
Auto Answer All		✓	
Auto Answer Intercom		✓	
Auto Dial Inside	✓		
Auto Dial Outside	✓		
Barge-In	✓		
Camp-on	✓		
Conference*	✓		
Coverage Off	✓		
Coverage VMS Off	✓		
Data Status	✓		
Direct Voice Mail	✓		
Do Not Disturb	✓		
Drop*	✓		
Extension Status 2 (Non-operator)	✓		
Extension Status 1 (Non-operator)	✓		
Feature Button		✓	
Forward	✓		
Group Calling	✓		
Group Paging	✓		
Headset Auto Answer			✓
Headset Hang Up			✓
Headset Status			✓
Headset/Handset Mute			✓
Last Number Dial [†]	✓		

* Behind Switch mode only.

Continued on next page

Table 4-1, Continued

Feature	Analog and MLX	Analog Only	MLX Only
Messaging:			
Delete Message		✓	
Leave Message	✓		
Message Light Off	✓		
Next Message		✓	
Posted Message	✓		
Return Call		✓	
Scroll		✓	
Park	✓		
Pickup:			
Group	✓		
General	✓		
Extension	✓		
Line	✓		
Privacy	✓		
Recall	✓		
Reminder Service			
Set	✓		
Cancel	✓		
Saved Number Dial†	✓		
Selective Callback	✓		
Signaling	✓		
System Access‡			
SA Originate Only	✓		
Voice Attribute on Button	✓		
Ring Attribute on Button	✓		
System Speed Dial	✓		
Transfer*	✓		

† Number is *not* copied.

‡ Ringing options (No, Delay, and Immediate Ring) are copied with the button.

* Behind Switch mode only.

The following are operator features that can be copied:

- Alarm
- Extension Status Off
- Extension Status 1
- Extension Status 2
- Missed Reminder
- Night Service
- Operator Park
- Send/Remove Message

Planning Form Instructions

1. On page 1 of Form 4a and/or Form 4c, write the extension number of the Master Extension and the extensions to which this template will be copied.
2. Complete the Button Diagram on page 2 of Form 4a and/or Form 4c, assigning features to the buttons.
3. On the individual telephone forms (Forms 4b, 4d, 4e, 5a, 5b and 5c) do the following:
 - a. By the extension information at the top of each page, check Copied from Master Extension No. and write the extension number of the Master Extension.
 - b. Under every form's Button Diagram heading, check the See Master Extension box.

Operator Features

Operator features apply only to DLCs, QCCs, and any Direct Station Selectors (DSSs) connected to them.

Forms Needed

- Form 2a, System Numbering: Extension Jacks
- Form 2d, System Numbering: Special Renumbers
- Form 5d, Queued Call Console (QCC)
- Form 6a, Optional Operator Features

Direct-Line Console

Use these instructions only if the system has one or more DLCs. Otherwise, skip to the next section, "Queued Call Console (Hybrid/PBX Mode Only)." This section contains instructions for the Operator Hold Timer and DLC Automatic Hold features.

Operator Hold Timer

This section contains instructions to set the operator hold timer to track the number of seconds callers are on hold for an operator. When a caller is on hold longer than the number of seconds programmed for the timer, the operator is reminded of the call by a single ring.

Planning Form Instructions

Under the Operator Hold Timer heading on Form 6a, do *one* of the following:

- To keep the factory setting, check 60 Seconds.
- To change the factory setting, check the second box and write the number of seconds (10 to 255 seconds) in the space provided.

DLC Automatic Hold

This section contains instructions to set DLC Automatic Hold to place calls on hold automatically when the operator presses another line button.

Planning Form Instructions

Under the DLC Automatic Hold heading on Form 6a, do *one* of the following:

- To keep the factory setting (no DLC Automatic Hold), check Disable.
- To automatically put calls on hold when another line button is pressed, check Enable.

If the system includes one or more QCCs, proceed to the next section. Otherwise, skip to the following section, "Direct Station Selector (DSS)."

Queued Call Console (Hybrid/PBX Mode Only)

Use these instructions only if the system has one or more QCCs. Otherwise, skip to the next section, "Direct Station Selector (DSS)."

This section contains instructions to set the following QCC operator features:

- Hold Return
- Automatic Hold or Release
- Queue Over Threshold
- Elevate Priority
- Calls-in-Queue Alert
- Message Center Operation
- Automatic or Manual Directed Call Completion
- Return Ring
- Position-Busy Backup
- Operator Hold Timer
- Call Types
- Voice Announce

Hold Return

This section contains instructions to specify whether calls put on hold by a QCC operator stay on hold indefinitely or are returned to the QCC queue after the Hold Timer has expired twice.

Planning Form Instructions

Under the Hold Return heading on Form 6a, do *one* of the following:

- To indicate that calls stay on hold after the hold timer has expired twice, check the Remain on hold (factory setting) box.
- To indicate that calls on hold return to the QCC queue after the hold timer has expired twice, check the Return to queue box.

Automatic Hold or Release

This section contains instructions to specify whether a call that is in progress on a **Call** button is automatically put on hold (Automatic Hold) or disconnected (Automatic Release) when the operator presses another **Call** button.

Planning Form Instructions

Under the Automatic Hold or Release heading on Form 6a, do *one* of the following:

- To specify that calls are automatically disconnected, check the Automatic Release box (factory setting).
- To specify that calls are automatically put on hold when another **Call** button is pressed, check the Automatic Hold box.

Queue Over Threshold

This section contains instructions to specify the maximum number of calls allowed in the QCC queue before operators are notified (with a tone through the receiver or headset) that calls are waiting.

Planning Form Instructions

Under the Queue Over Threshold heading on Form 6a, do *one* of the following:

- To keep the factory setting (operators are not notified), check the 0 calls box.
- To indicate that operators are notified when calls are waiting in the queue, check the second box and write the maximum number of calls in the queue before notification (any number from 1 through 99) in the space provided.

Elevate Priority

This section contains instructions to arrange the QCC queue so that important business calls are answered first.

NOTE:

During high-volume calling periods this means that only high-priority calls are delivered to a QCC within a reasonable amount of time, and low-priority calls go unanswered. To review call priority assignments, see "QCC Queue Priority Level" in Chapter 3, "Lines/Trunks."

The setting for the Elevate Priority option determines the length of time (in seconds) before the calls waiting in the QCC queue are automatically assigned a higher level of priority. Although the priority of every call in the queue is then increased to a higher level, a call is never increased to highest priority (1) because priority 1 calls are those that must reach the operator as quickly as possible.

Planning Form Instructions

Under the Elevate Priority heading on Form 6a, do *one* of the following:

- To indicate that the order of priority is not changed, check the 0 Seconds box (the factory setting).
- To indicate that call priority is reordered, check the second box and write the number of seconds in the space provided. (Select any number from 5 through 30 depending on the number of priority levels assigned to calls ringing into the queue and the volume of incoming calls. The recommendation for typical systems is 8 seconds.)

Calls-in-Queue Alert

This section contains instructions for setting the Calls-in-Queue Alert option to notify QCC operators (with a single beep) when a new call enters the QCC queue.

Planning Form Instructions

Under the Calls-in-Queue Alert heading on Form 6a, do *one* of the following:

- To keep the factory setting (QCC operators are *not* notified when calls are waiting in queue), check the Disable box.
- To specify that particular QCC operators are notified (with a single beep) when a call enters the queue, check the Enable box and, in the space provided, write the extension number of each QCC position that receives the notification (see Form 2a or Form 5d).

Message Center

This section contains instructions to assign this feature when there is more than one QCC operator position and the customer wants one centralized location where employees retrieve messages. Usually only one message center position is necessary, but there can be several QCCs in one room sharing messaging duties. The Message Center option allows you to designate a QCC as a message center with the following options automatically set:

- The only incoming calls that go to the message center QCC are calls to the extension number of the QCC and calls sent to the QCC using Forward or Follow Me.
- Returning calls (such as those sent to an extension, operator-parked, and camp-on calls) go to the message center QCC. This means that the message center position is different from that of the system operator who originally answered the call.
- Group Coverage calls go to the QCC message center.
- DID calls to invalid destinations (unassigned extension numbers) go to the QCC message center.

Planning Form Instructions

Under the Message Center heading on Form 6a, do *one* of the following:

- To indicate that no message center operator is assigned, check the No box.
- To assign a message center, check the second box and write the extension of the QCC operator position in the space provided (see Form 2a or 5d).

Directed Call Completion

Use these instructions only if the system has a QCC with a Direct Station Selector (DSS). Otherwise, skip to the next section, "Return Ring."

This section contains instructions for changing the factory setting for Directed Call Completion from Automatic to Manual (that is, the QCC operator must press the **Release** button when using a DSS button to direct a call).

Planning Form Instructions

Under the Extended Call Completion heading on Form 6a, do *one* of the following:

- To keep the factory setting, check the Automatic completion box.
- To require the operator to use the **Release** button to direct calls, check the Manual completion box.

Return Ring

This section contains instructions to specify the number of rings before an unanswered call is returned from the extension where it was sent to the QCC queue (or QCC message center position).

If the system includes a voice mail system, you should increase this number to ensure that the voice mail system gets the call before it is returned.

Planning Form Instructions

Under the Return Ring heading on Form 6a, do *one* of the following:

- To keep the factory setting, check the 4 Rings box.
- To change the factory setting, check the second box and write the number of rings you want to assign in the space provided (1 through 15 rings).

Position-Busy Backup

This section contains instructions to assign another telephone to receive calls when all QCC operator consoles are in a position-busy state. Only a calling group can be assigned as a backup for a QCC operator position. If a backup is not designated, the system does not allow the last available operator position to go into the position-busy state.

Planning Form Instructions

Under the Backup On heading on Form 6a, do *one* of the following:

- To indicate that no backup is assigned, check the No box (factory setting).
- To designate a backup, check the second box (the extension number of the backup calling group will be completed later).

Operator Hold Timer

This section contains instructions to set the system to track the number of seconds that callers are on hold at an operator console. When a caller is on hold longer than the number of seconds programmed for the timer, the operator is reminded by a single ring.

Planning Form Instructions

Under the Operator Hold Timer heading on Form 6a, do *one* of the following:

- To keep the factory setting, check the 60 Seconds box (factory setting).
- To change the factory setting, check the second box and write the number of seconds (from 10 to 255 seconds) in the space provided.

Call Types

This section contains instructions to assign a QCC operator to receive certain types of calls and to set the QCC queue priority level.

Planning Form Instructions

The Group Coverage Calls section on the back of Form 6a will be completed later in this chapter.

Under the Call Types heading on Form 6a (page 2):

1. In the QCC Operator to Receive Calls column, for each call type, do *one* of the following:
 - If QCC operators are not to receive the call type, write **None**.
 - If one or more QCC operators are to receive the call type, write any combination of the extension number(s). See Form 2a or 5d.

NOTE:

You cannot assign an operator to either Follow Me calls or calls to QCC operator extensions.

2. In the QCC Queue Priority Level column, write the level for each call type. Assign a value of 1 (high priority) through 7 (low priority). The factory setting is 4.

Voice Announce

This section contains instructions to enable a QCC operator to originate Voice Announce (VA) calls. When enabled, the **Call 5** button on the QCC can originate Voice Announce calls.

NOTE:

QCCs cannot receive Voice Announce calls.

Planning Form Instructions

Under the Voice Announce heading on Form 6a, do *one* of the following:

- To prevent QCC operators from originating Voice Announce calls, check the Disable box (factory setting).
- To allow QCC operators to originate Voice Announce calls, check the Enable box.

Direct Station Selector

Use these instructions only if the system has Direct Station Selectors (DSSs) connected to MLX operator consoles. Otherwise, skip to the next section, "Group Assigned Features."

This section contains instructions for recording the range of extensions assigned to the **Page** buttons, and for renumbering the extensions for Park so that the extensions fall within the **Page** button ranges.

Page Buttons

This section contains instructions for recording the range of extensions assigned to each of three **Page** buttons. The three **Page** buttons should be set to reach ranges of numbers that include the extension numbers in the extension numbering plan and reflect the number of extensions available:

- If one DSS is connected to an operator console, set each **Page** button for a range of 50 numbers (matching the 50 available extensions).
- If two DSSs are connected, set each **Page** button for a range of 100 numbers. The **Page** buttons then control 100 extensions, 50 on each DSS.

NOTE:

If two DSSs are used, the **Page** buttons on the second selector are not active.

Planning Form Instructions

In the Page Buttons table under the Direct Station Selector heading of Form 6a (page 1), write the beginning extension for the range of the 50 or 100 extension numbers for each **Page** button. Assign the lowest extension numbers in the plan to the first **Page** button, the middle range of numbers to the second **Page** button, and the highest extension numbers to the third **Page** button. (Use the information from Form 2a, System Numbering: Extension Jacks to assign the range of extensions for each **Page** button.) Also, record this information on Form 2d under the DSS Page Buttons heading.

Park Zones

This section contains instructions to enable operators with a DSS to have one-touch use of Park, that is, to put calls into a special type of hold so that the calls can be picked up from any telephone in the system. The system automatically reserves eight extensions (881–888) for system operator park zones; only system operators can use these park zone extensions to park calls. Consider changing these factory-set extensions to numbers that fall within the **Page** button ranges. The same considerations apply as those used during reassignment of extension numbers.

Planning Form Instructions

In the Call Park Codes table under the Direct Station Selector heading on Form 6a:

- Write the new Zone numbers assigned in the Renumber to columns.
- On Form 2d, System Numbering: Special Renumbers, write the new numbers in the Renumber to column of the Park Zone section of that form.

Group-Assigned Features

The system offers the following features to facilitate the call-handling responsibilities of groups of users:

- Call Pickup Groups
- Group Paging
- Coverage
- Group Calling

This section contains instructions for recording information about these features.

To determine whether any of the group-assigned features are appropriate for system users, see the analysis of the Employee Communication Survey.

Forms Needed

- Form 2a, System Numbering: Extension Jacks
- Form 2d, System Numbering: Special Renumbers
- Form 4b, Analog Multiline Telephone
- Form 4d, MLX Telephone
- Form 5a, Direct-Line Console (DLC): Analog
- Form 5b, Direct-Line Console (DLC): Digital
- Form 6a, Optional Operator Features
- Form 7a, Call Pickup Groups
- Form 7b, Group Paging
- Form 7c, Group Coverage
- Form 7d, Group Calling

Call Pickup Groups

This section contains instructions for assigning this feature to employees who work in a common area and who do not have a support person for coverage. You can assign up to 30 call pickup groups with up to 15 telephones for each group. Each telephone can be assigned to only one group.

NOTE:

This feature is similar to the Coverage feature presented later in this chapter. Compare these features before choosing the appropriate feature for the system.

Planning Form Instructions

1. Form 7a holds the programming information for eight Call Pickup groups. Make additional copies of the form if more groups are planned. Review the analysis of question 10 on the Employee Communication Survey, and determine the number of call pickup groups needed (maximum of 30).
2. For each group, write the group number in the Group Number space. Start with 1 and number the groups sequentially.
3. Write the name of a group, such as Customer Service in the Group ID space (see the survey analysis).
4. Write the extension number for each group member in the Ext. No. column (see Form 2a).
5. Write each group member's name or location in the Person or Location column (see Form 2a).

Group Paging

This section contains instructions for setting the system to allow users to make voice announcements that are heard by a particular group of employees with speakerphones or by everyone who has a speakerphone.

You can assign six paging groups of selected employees, such as secretarial pools, committee members, or departments, who need to hear announcements. Each group can have as many as 10 extension numbers.

The seventh paging group is factory-set to page all extension numbers. This group is useful if the system does not have a loudspeaker paging system.

The system automatically reserves extension numbers 793 through 799 for paging groups. Extension 799 is the Page All group. Decide whether to keep or to reassign the factory-set extension numbers. Keep in mind that you can provide one-touch use of Group Paging to operators with DSSs if you renumber to extensions within the Page 1, 2, or 3 button ranges or set the **Page 1, 2, or 3** buttons so the operators can access them.

Planning Form Instructions

1. Determine the number of paging groups needed.
2. For each group, write the name of the group, such as **Sales**, in the Group ID space on Form 7b.
3. To change the factory-set extension numbers:
 - a. Write the new numbers in the Renumber to space.
 - b. On Form 2d, System Numbering: Special Renumbers, write the new numbers in the Renumber to column of the Group Paging section of that form.
4. Write the extension number for each group member in the Ext. No. column (see Form 2a).
5. Write each group member's name or location in the Person or Location column (see Form 2a).

Coverage

Coverage allows calls to extensions (called *senders*) to be covered by one or more other extensions (called *receivers*). Coverage can be individual or group-assigned. This section contains instructions for both types (see "Call Restriction" earlier in this chapter for more information).

Forms Needed

- Form 2a, System Numbering: Extension Jacks
- Form 4b, Analog Multiline Telephone
- Form 4d, MLX Telephone
- Form 5a, Direct-Line Console (DLC): Analog
- Form 5b, Direct-Line Console (DLC): Digital
- Form 6a, Optional Operator Features
- Form 8a, System Features

Individual Coverage

This section contains instructions to allow an arrangement in which calls from one sender are covered by one or more receivers. A receiver can provide primary Individual Coverage or secondary Individual Coverage.

A sender can have calls covered by up to eight receivers, and a receiver (such as a secretary) can provide Individual Coverage for more than one sender (up to eight buttons on one receiver telephone). Any type of telephone can be a sender; only a multiline telephone with programmable buttons available can be a receiver. The receiver must have a programmed Cover button for each sender whose calls are being covered.

NOTE:

See "Coverage" in the *Feature Reference* for additional information regarding Coverage.

Calls on lines programmed for No Ring are not covered.

If a principal user is assigned, calls that would be sent to Group Coverage are sent only to the principal's Group Coverage receivers. If the principal user has Remote Call Forwarding on, calls are sent to an outside number rather than to the coverage receivers.

Planning Form Instructions

1. Review the Employee Communication Survey analysis and determine which users (senders) need Individual Coverage.

NOTE:

Single-line telephones cannot be receivers, and QCCs cannot be senders or receivers.

2. On the appropriate form for each receiver telephone (Form 4b, 4d, 4f, 5a, or 5b), locate an available button on the Button Diagram and write **Ind Cover** and the sender's extension number. Write **P** to indicate primary or **S** to indicate secondary Individual Coverage.

Group Coverage

In Group Coverage, senders are organized into groups, and calls received by any member of the group are sent to a receiver.

Any type of telephone (excluding QCCs) can be a member of a coverage group; however, no individual sender can be a member of more than one group. A maximum of 32 coverage groups can be set up, and there is no limit to the number of senders in each group. Three types of receivers can be programmed: calling groups, or the QCC queue and/or multiline telephones.

NOTE:

Group Coverage can be used alone or can be set up to work with either primary or secondary Individual Coverage, or both. This allows callers to get personal attention from the primary and/or secondary Individual Coverage receiver and backup from Group Coverage. For example, a receiver such as a secretary can have a Primary Cover button to provide Individual Coverage for a sender who is also a member of a coverage group.

Planning Form Instructions

1. Form 7c holds information for eight coverage groups. Make additional copies of the form if more groups are planned. Review the Employee Communication Survey analysis and determine the senders to be grouped.
2. Form 8a is used to identify system features. Under the Coverage Delay Interval heading at the top of Form 8a, do *one* of the following:
 - To keep the factory-set interval, check the 3 rings box.
 - To change the factory-set interval, check the second box and write the number of rings (1 to 9) in the space provided.
3. Under the Delay Ring Interval heading, do *one* of the following:
 - To keep the factory-set interval, check the 2 rings box.
 - To change the factory-set interval, check the second box and write the number of rings (1 to 6) in the space provided.
4. On Form 7c:
 - a. Write the group number in the Group No. space. Start with 1 and number the groups sequentially.

NOTE:

If a group is the coverage group for AUDIX Voice Power (the factory setting is Group No. 30 but can be changed), write **AUDIX** by the group number and list the extensions of AUDIX Voice Power subscribers (see Form 2a).

- b. List the extension numbers of all senders in the group in the upper block (see Form 2a).
- c. List the receivers for the group in the lower block by doing one of the following:

NOTES:

- 1. If you have not yet created calling groups, you must defer naming them as receivers until later.
- 2. If the system includes a voice mail system, see that system's documentation for completing the receivers.
 - Designate a calling group as a receiver by checking the Calling Group box (see Form 7d).
 - Designate the QCC queue as a receiver (Hybrid/PBX mode only) by checking the QCC Queue box and/or listing the extension numbers of all receivers (maximum of eight).
- 5. On each copy of Forms 4b, 4d, 5a and 5b that describes a specific receiver:
 - a. Locate an available button on the Button Diagram.
 - b. Write **Group Cover** and the coverage group number in the space available.
- 6. If designating the QCC Queue as a receiver (Hybrid/PBX mode only), on the Group Coverage Calls table on Form 6a (page 2):
 - a. Write the extension(s) for the QCC operator position(s) to receive the calls in the QCC Operator to Receive Calls column (see Form 2a).
 - b. Write the level for each coverage group's calls in the QCC Queue Priority Level column. Assign a value of 1 (highest) through 7 (lowest); the factory setting is 4.

Group Calling

This section contains instructions to group the telephones of people (such as ticketing agents) who handle the same type of call. Through the Group Calling feature, all telephones in the group are assigned to a single extension number that is used by both inside and outside callers to reach the group. The individual extension numbers of the telephones are still used by callers who need to reach a specific member of the calling group.

NOTE:

The Extension Status feature must be set for the Group Calling/CMS configuration in order for calling groups to be available. See the "Extension Status" instructions later in this chapter for details.

The system automatically reserves extension numbers 770 through 791 and 7920 through 7929 for calling groups (these may be changed). If operators with DSSs need one-touch Group Calling, renumber the extensions that fall within the **Page** button ranges.

If the system has AUDIX Voice Power/Fax Attendant System, certain extension numbers are reserved as follows:

7924	Fax Response
7925	Voice Mail
7926	Call Answer
7927	Information Service
7928	Message Drop
770	Automated Attendant

Calling groups can be part of the group assignment for Night Service as described later in this chapter.

Planning Form Instructions

1. Review the Employee Communication Survey analysis and determine the number of calling groups needed using the following guidelines:
 - Assign up to 32 calling groups with up to 20 members for each group. Each telephone user can be a member of only one calling group.
 - Designate particular lines/trunks to ring directly into a calling group. Incoming calls on a given line/trunk can be directed to only one calling group.
 - If the AT&T Attendant or another VMS is being used, reserve one or more calling groups for that feature.
2. For each calling group, make a copy of both sides of Form 7d, Group Calling.
3. For each group, on the front of Form 7d, list the extensions and lines/trunks assigned to the group:
 - a. Write the group number in the Group No. space. Start with 1 and number sequentially.
 - b. Write the name of the group in the Group Name space (see the survey analysis).

NOTE:

If the system has AUDIX Voice Power/Fax Attendant System, fill in only the group number and group name here, then fill in the rest of the Group Calling information on Forms B and C of the AUDIX Voice Power planning forms.

c. Do *one* of the following:

- To use a factory-set extension number, write the number in the space provided (**770** for group 1, **771** for group 2, and so on).
- To change a factory-set extension number, write the new number in the Renumber to space, and then on Form 2d, System Renumbering: Special Renumbers, write the group name in the Group ID Label column (maximum: 7 characters) and the new number in the Renumber to column of the Group Calling section of that form.

NOTE:

Before you complete the extension number and name entries in Step 4, read Step 2 of the instructions in the next section, "Calling Group Options."

4. In the Extensions section of Form 7d, write the extension number of each member of the group in the Ext. No. column and the name of the person or location in the Person or Location column (see Form 2a).
5. In the Trunks/Pool table of Form 7d, for each line/trunk that is to ring directly into the calling group, write the line/trunk or pool number (see Form 2c).

NOTE:

If a line/trunk is in a pool, the whole pool should be assigned. Also, before adding to a calling group, you must first remove lines/trunks from the QCC.

6. If assigning a calling group as backup for a QCC, under the Position Busy Backup heading in the Queued Call Console section of Form 6a, Optional Operator Features, check yes and write the extension number of the calling group.
7. To record information for another calling group, repeat this procedure beginning with Step 3; use a blank Form 7d for each group.

Calling Group Options

This section contains instructions for following calling group options:

- Hunt Type
- Delay Announcement
- Message-Waiting Receiver
- Calls-in-Queue Alarm Threshold
- External Alert for Calls-in-Queue Alarm
- Overflow Coverage
- Overflow Threshold
- Overflow Threshold Time
- Group Type

Only one announcement device can be designated for each calling group; however, more than one calling group can use the same announcement device. The announcement device should not be assigned as a group member, and it must be outward-restricted to prevent unauthorized calls.

Each calling group can have only one telephone assigned as its message-waiting receiver. The same telephone can be assigned as the message-waiting receiver for more than one calling group.

The external alert designated as a calls-in-queue alarm can be any alerting device connected through an MFM in the External Alert mode for MLX telephones. Only one external alert can be designated for each calling group. Since the signal is continuous, you should only use lighted external alerting devices. An alert connected to a Supplemental Alert Adapter for an analog multiline telephone should not be used as a calls-in-queue alarm.

The Overflow Threshold determines the maximum number of calls waiting in the calling group queue before being sent to the Overflow receiver. The Overflow Threshold Time determines the maximum amount of time that any call waits in the queue before being sent to the Overflow receiver. The Overflow Threshold should be set to a number larger than the Calls-in-Queue Alarm Threshold to ensure that the Calls-in-Queue Alarm will alert before calls are sent to the Overflow receiver. If the Overflow Threshold Time is the primary source for overflow, set the Overflow Threshold to a large number of calls (for example, 99 calls). If you want calls to overflow based on the number of calls in the queue, disable the Overflow Threshold Time by setting it to 0 seconds.

Planning Form Instructions

NOTE:

If the system has AUDIX Voice Power/Fax Attendant, you do not need to fill in this information; settings are automatically set by Integrated Administration to factory settings assumed by the AUDIX Voice Power system (and not necessarily those listed for the communications system on Form 7d). Changing the assumed factory settings could affect how the AUDIX Voice Power system works. If you change these values, *do so with caution*, and record the settings on Form 7d. For more information, see the AUDIX Voice Power documentation.

For each calling group:

1. On Form 7d (page 2), copy the Group No., ID, and extension number from the front of the form.

2. Select the Hunt Type by doing *one* of the following:

- To keep the factory-set hunting pattern, check the Circular box.

NOTE:

If you choose a linear hunt, be sure you have listed the extension numbers and names in the Extensions section on Form 7d (page 1), in the order that you want the group searched. If you have not done this, go back and correct the front of the form so that the extensions are in the right order.

- To change the factory-set hunting pattern, check the Linear box.
3. Under the Delay Announcement heading, do *one* of the following:
 - If there is no announcement device, check the No box and proceed to Step 4.
 - To designate an announcement device, check the second box and write the extension number for the device in the space provided (see Form 2a or 2b).
 4. To designate a telephone to receive message-waiting indications for the group, do *one* of the following under the Message-Waiting Receiver heading on Form 7d (page 2):
 - To assign no receiver, check the No box.
 - To assign a receiver, check the second box and write the extension number of the message-waiting receiver (see Form 2a).
 5. Under the Calls-in-Queue Alarm Threshold heading, do *one* of the following:
 - To keep the factory setting, check the 1 Call box.
 - To change the factory-set number of calls allowed in the queue before members are notified, check the second box and write the number of calls (up to 99) in the space provided.

6. Under the External Alert for Calls-in-Queue Alarm heading, do *one* of the following:
 - For no external alert for Calls-in-Queue Alarm, check the No box.
 - To designate an external alert, check the second box and write the extension number for the alert in the space provided (see Form 2b).
7. Under the Overflow Coverage heading, do *one* of the following:
 - For no overflow coverage, check the No box.
 - To designate overflow coverage by another calling group, check the second box and write the calling group number of the overflow calling group in the space provided.
 - To designate that overflow coverage will be provided by QCC operators, check the third box and write the QCC LDN (queue) extension number in the space provided.
8. Under the Overflow Threshold heading, do *one* of the following:
 - To retain the factory setting, check the 1 call box.
 - To change the threshold, check the second box and write the number of calls (up to 99) in the space provided.
9. Under the Overflow Threshold Time heading, do one of the following:
 - To retain the factory setting and disable the Overflow Threshold Time, check the 0 seconds box.
 - To change the threshold, check the second box and write the maximum number of seconds (from 1 to 900) calls wait in the queue in the space provided.
10. Under the Group Type heading, do *one* of the following:
 - To keep the factory setting of no automatic login, check the Auto Logout box.
 - To change the factory setting from Auto Logout, do *one* of the following:
 - Check the Auto Login box to indicate automatic login for an extension that should never be logged out, such as a data extension.
 - Check the Integrated VMI box to indicate automatic login for a VMS that requires special signaling for integrated operation.
 - Check the Generic VMI box to indicate automatic login for a VMS that does not require special signaling.

Proceed to the next section, "System Features."

System Features

System features affect all users and all or most telephones. For more information on system features, see the *Feature Reference*.

This section contains instructions for assigning the following system features:

- Transfer of calls
- Camp-On Return Time
- Call Park Return Time
- Automatic Callback
- Extension Status
- Station Message Detail Recording (SMDR)
- Inside Dial Tone
- Reminder Service Cancel
- Redirect Calls to Unassigned Extension Numbers
- Recall Timer
- Rotary-Dial Delay
- Allowed Lists
- Disallowed Lists
- Night Service
- Labeling
- Automatic Route Selection

Forms Needed

- Form 3e, Automatic Route Selection Worksheet
- Form 3f, Automatic Route Selection Tables
- Form 3g, Automatic Route Selection Default and Special Numbers Tables
- Form 6e, Allowed Lists
- Form 6f, Disallowed Lists
- Form 6g, Call Restriction Assignments and Lists
- Form 8a, System Features
- Form 9a, Night Service: Group Assignment
- Form 9b, Night Service: Outward Restriction
- Form 9c, Night Service: Time Set

- Form 10a, Label Form: Posted Message
- Form 10b, System Speed Dial

Transfer Options

This section contains instructions for setting the following Transfer feature options to allow users to transfer outside or inside calls to another telephone:

- Transfer Return Interval
- One-Touch Transfer
- Transfer Audible
- Type of Transfer

NOTE:

Transfer features, and any other feature that requires more than one **SA** button, can be disabled on Single-line telephones by removing all but one **SA** button through centralized programming. Refer to Form 4f, Tip/Ring Equipment.

Planning Form Instructions

NOTE:

If the system includes AUDIX Voice Power/Fax Attendant System, Integrated Administration automatically sets the Return Time Interval to 6. If the system does not include integrated administration, but does have a voice mail system, the interval should be set to a value greater than 4 so that the voice mail system will get the call first.

1. Under the Return Time Interval heading in the Transfer Options section of Form 8a, do *one* of the following:
 - To keep the factory setting, check the 4 rings box.
 - To indicate no return for transferred calls, check the 0 rings box.
 - To change the factory-set number of rings, check the third box and write the number of rings (1 through 9) in the space provided.
2. Under the One-Touch Call Handling heading, do *one* of the following:
 - To keep the factory setting, check the One-Touch Transfer box and do *one* of the following:
 - Check the Automatic Completion box to keep the factory-set automatic completion of transfers.
 - Check the Manual Completion box to change the factory setting to manual completion.
 - To change from One-Touch Transfer to One-Touch Hold, check the One-Touch Hold box.

3. Under the Transfer Audible heading, do *one* of the following:

NOTE:

If programmed for Music On Hold and a music source is provided, outside callers who are transferred to a calling group, are waiting in the queue, or outside callers who are parked or camped-on, will hear music while they are waiting.

- If the system should play music while callers are on hold for transfer, check the Music On Hold box.
- If the system will not provide music, check the Ringback box.

4. Under the Type of Transfer heading, do *one* of the following:

- For the system to select a Ring button for transferred calls, check the Ring button box (factory setting).
- For the system to select a Voice button for transferred calls, check the Voice button box.

Camp-On Return Time

This section contains instructions for designating the number of seconds a caller waits when transferred to a busy extension by way of the Camp-On feature. If the telephone is still busy at the end of the programmed interval, the call returns to the person who transferred the call.

Planning Form Instructions

Under the Camp-On Return Time heading on Form 8a, do *one* of the following:

- To keep the factory-set interval, check the 90 seconds box.
- To change the factory-set interval, check the second box and write the number of seconds (30 through 300) in the space provided.

Call Park Return Time

This section contains instructions for designating the number of seconds a caller waits when a person uses the Call Park feature to put a call on hold. If the call is not picked up at the end of the programmed interval, the call returns to the person who parked the call.

Planning Form Instructions

Under the Call Park Return Time heading on Form 8a, do *one* of the following:

- To keep the factory-set interval, check the 180 seconds box.
- To change the factory-set interval, check the second box and write the number of seconds (30 through 300) in the space provided.

Automatic Callback

This section contains instructions for setting the number of rings the system should use to alert a caller about a callback attempt. After the specified number of rings, the system abandons the callback attempt.

Planning Form Instructions

Under the Automatic Callback Interval heading on Form 8a, do *one* of the following:

- To keep the factory-set interval, check the 3 rings box.
- To change the factory-set interval, check the second box and write the number of rings (1 through 6) in the space provided.

Extension Status

This section contains instructions to set Extension Status to allow an operator, a calling group supervisor, or a Call Management System (CMS) supervisor to determine the status of a telephone at a glance. The lights next to the buttons on a DSS or next to Auto Dial buttons programmed with extension numbers indicate the status of the telephone.

Decide on the configuration and assign operator positions to monitor extension status.

Planning Form Instructions

Under the Extension Status heading on Form 8a:

1. Check the Assign to operator positions box and write the extension number for each operator position in the space provided (see the appropriate copy of Form 5a, 5b, or 5d).
2. Do *one* of the following:
 - To keep the factory-set configuration, check the Group Calling/CMS box.
 - To change the configuration, check the Hotel box.

SMDR (Station Message Detail Recording)

Use these instructions only if connecting a Station Message Detail Recording (SMDR) device. Otherwise, skip to the next section, "Inside Dial Tone."

This section contains instructions for setting up SMDR to keep track of telephone usage. SMDR works in conjunction with the Call Accounting System (IS CAS, CAS Plus V3, and CAS for Windows) or a serial printer connected to the SMDR port on the control unit. The SMDR port is the upper RS-232 jack on the processor module.

Two SMDR report formats are available: the factory-set Basic format or the ISDN format. The ISDN format is used when the business subscribes to the AT&T INFO2 automatic number identification service (ANI). When the system is set for ISDN format, the actual number dialed by the caller appears on the report. The rest of the fields are identical to the Basic format.

NOTES:

1. For accurate reports, the system date must be set to the current date when the system is installed. Be sure you checked the Yes box on Form 1 under Set System Date.
2. For systems where the majority of lines are PRI facilities, the SMDR Call Length should be programmed for one second.

Planning Form Instructions

In the SMDR Options section of Form 8a:

1. Under the Call Format heading, do *one* of the following:
 - To keep the factory-set format, check the Basic box.
 - To change the report format, check the ISDN box.
2. Under the Call Length heading, do *one* of the following:
 - To keep the factory-set call length, check the 40 seconds box.
 - To change the factory-set call length, check the second box and write the number of seconds (0 through 255) in the space provided.
3. Under the Calls Reported heading, do *one* of the following:
 - To keep the factory setting, check the Incoming and outgoing box.
 - To change the factory setting, check the Outgoing only box.

Inside Dial Tone

This section contains instructions for specifying whether the system uses an inside dial tone that is different from or the same as outside line/trunk dial tone. The factory setting is for a different inside dial tone. How you set the system for dial tone is a matter of preference.

NOTE:

Regardless of how you set this option, VMSs receive outside dial tones. Some modems may require outside dial tone to dial out.

Planning Form Instructions

Under the Inside Dial Tone heading on Form 8a, do *one* of the following:

- To keep the factory-set system inside dial tone, check the Inside box.
- To change the dial tone to match the outside dial tone, check the Outside box.

Reminder Service Cancel

This section contains instructions for assigning a preset time when the system cancels all reminders.

Although all users can set and cancel reminder calls for their own telephones, and DLC system operators can set and cancel reminder calls for any telephone in the system, Reminder Service Cancel automatically cancels all reminder calls at the preset time, for example, at the end of the business day when all users have gone home and are not available to receive reminders.

Planning Form Instructions

Under the Reminder Service Cancel heading on Form 8a, do *one* of the following:

- To set no reminder service cancel time, check the No box.
- To set a time to cancel all reminders in the system, check the second box and write the time of day in the space provided.

Calls to Unassigned Extensions

This section contains instructions for designating that calls made to unassigned extension numbers by remote access users or on DID or dial-in tie trunks are redirected to another extension number, the QCC queue, or a calling group instead of to the primary operator.



SECURITY ALERT:

DID numbers that correspond to pool dial-out codes (or facility access codes) can be used to avoid toll restriction, leading to toll abuse and/or fraud. (See Appendix A, "Customer Support Information" for more information about security.)

Planning Form Instructions

Under the Calls to Unassigned Extensions heading on Form 8a, do *one* of the following:

- To keep the factory setting, check the Extension box.
- To change from the factory-set redirect to the primary operator, check *one* of the following:
 - To redirect calls to a QCC operator (Hybrid/PBX only), check the QCC queue box and write the extension number in the space provided (see Form 2a).
 - To redirect calls to another telephone, check the Extension box and write the extension number in the space provided (see Form 2a).
 - To redirect calls to a calling group, check the Calling Group box and write the calling group extension number in the space provided (see Form 7d).

Recall Timer

This section contains instructions for designating the length of the switchhook flash sent when Recall is used to disconnect a call and get a new dial tone without hanging up. The interval of the switchhook flash and how Recall works depends on the type of telephone being used.

For multiline telephones, the factory setting is 450 ms. If users experience difficulty with Recall, the interval can be changed to a longer or shorter interval. The single-line telephone **Flash** or **Recall** button transmits a timed switchhook flash of about half a second.

Planning Form Instructions

Under the Recall Timer heading on Form 8a, check *one* of the following:

- 350 ms
- 450 ms (factory setting)
- 650 ms
- 1 sec

Rotary

This section contains instructions for designating whether dialed digits on rotary-dial lines/trunks are sent one by one as they are dialed or are stored and sent when dialing is completed.

Planning Form Instructions

Under the Rotary heading on Form 8a, check *one* of the following:

- To store digits and send them when dialing is completed, check the Delay (factory setting) box.
- To send digits out as they are dialed, check the No Delay box.

Allowed Lists



SECURITY ALERT:

If you assign a 0 (zero) as the first digit for any entry in an Allowed List, any toll restrictions assigned for calls to numbers that can be placed by local or toll operators are removed.

Use the instructions in this section and the next ("Disallowed Lists") only if calling restrictions are assigned to any telephones. Otherwise, skip to the section, "Night Service."

This section contains instructions to designate an Allowed List of telephone numbers that a restricted telephone can dial.

You can design up to 8 lists, each with a maximum of 10 numbers. Each number can have up to 6 digits, for example, an area code followed by an exchange. If a toll-call prefix is required, you can include a leading 1, which the system doesn't count as one of the 6 digits. Star codes (such as *67) may also be included in the list to allow users to access special services offered by the Central Office (CO). Once you have designed the lists, decide which restricted telephones have access to the lists. Each restricted telephone can have up to 8 lists.



SECURITY ALERT:

In some instances, after dialing a star code the CO responds with a second dial tone as a prompt to enter additional digits. If a caller begins dialing additional digits before the second dial tone, system restrictions may be bypassed and a restricted call may be routed. Careful administration of the Second Dial Tone Timer prevents the caller from bypassing call restrictions in this manner. Refer to the Planning Form Instructions that follow for information.

If foreign exchange (FX) or tie trunks are connected to the system, you can enter the exchange in the Allowed List to allow people with restricted telephones to dial numbers to the area code for the FX or tie trunk. As you design each list, consider which numbers need to be called by specific groups of restricted users.

Planning Form Instructions

On Form 6e:

1. Write the name of the list in the space next to the list number.
2. Write the allowed area codes, exchanges, and/or star codes in the spaces provided (a maximum of 10 entries for each list).
3. If star codes are included in the Allowed List, the Second Dial Tone Timer must also be administered. This timer induces a time delay before the user may dial additional digits after a star code, and is activated once a star code has been accepted. The dialing of any digits before this timer expires is treated as if normal restrictions have been violated and the call is not completed. The timer may be set from 0 to 5000 ms in increments of 200 ms. The system default is 0. On Form 1 (page 2), System Planning, write the desired setting for the Second Dial Tone Timer.
4. Write the extension numbers of the telephones that need access to the list in the Allow to Ext. Nos. column (see Form 2a).
5. If you planned Remote Access with restrictions and want to permit Allowed List numbers to be called by remote access users, then do the following:

NOTE:

Allowed List Class of Restriction assignments apply to all remote access users and cannot be assigned on an individual basis.

- a. On Form 3a (page 3), Incoming Trunks: Remote Access, in the Class of Restrictions without Barrier Codes section, write the list numbers under the Allowed List Access heading for either or both tie and non-tie trunks.
- b. On all copies of Form 3a (page 4), Class of Restriction with Barrier Codes, write the list numbers under the Allowed List Access heading for each barrier code assigned.

Disallowed Lists

This section contains instructions for using Disallowed Lists to prevent people from making calls to specific numbers, whether or not restrictions are specified for an extension. You can use this feature instead of restricting telephones totally from making toll or local calls.



SECURITY ALERT:

Be sure to review the toll fraud information with regard to Disallowed Lists in Appendix A, "Customer Support Information."

Use a "wild card" character to indicate that you want calls to an exchange restricted in every area code. During system programming, a Pause (entered using the **Hold** button) indicates a wild card character; therefore, use the letter "p" to indicate on the form that a wild card character should be programmed.

You can design up to 8 lists with a maximum of 10 numbers. Each number can have up to 11 digits, for example, a leading 1 (if a toll-call prefix is required for dialing) followed by the area code and telephone number. Star codes (such as *67) may also be included in the list to block users from accessing special services offered by the Central Office. Once you have designed the lists, decide which telephones to restrict. You can assign up to eight lists for each telephone.

Disallowed List #7 is the system default list and includes the numbers most frequently associated with fraud. The table below lists the default entries for Disallowed List #7.

Table 4-2. Disallowed List #7 Default Entries

0
10
11
1809
1700
1900
976
1ppp976
★

NOTE:

Users cannot dial a number on an Allowed List if it matches a number on a Disallowed List assigned to the telephone.

Planning Form Instructions

On Form 6f:

1. Write the name of the list in the space next to the list number.
2. Write the disallowed area codes, exchanges, and/or star codes in the spaces provided (a maximum of 10 entries for each list). Use the wild card character ("p") to restrict an exchange from being dialed in any area code. For example, to prevent users from directly dialing the 976 exchange in any area code, write **1 p p p 9 7 6**.

NOTE:

On Form 6f (page 3), Disallowed List #7 contains default entries (as shown in Table 4-2 above) and is the system default disallowed list. To change the entries in this list, cross out the default entry and write the new values in the space provided.

3. Write the extension numbers of the telephones that you want to assign to the list in the Disallow to Ext. Nos. column (see Form 2a).
4. Disallowed List Class of Restriction assignments apply to all remote access users and cannot be assigned on an individual basis. Use Form 3a, Incoming Trunks: Remote Access, if you planned Remote Access and want to restrict callers through Disallowed Lists:
 - a. On Form 3a (page 3), in the Class of Restriction without Barrier Codes section, write the list numbers under the Disallowed List Access heading for either or both tie and non-tie trunks.



SECURITY ALERT:

To help prevent toll fraud, barrier codes should always be assigned and should also be the maximum length allowed.

- b. On all copies of Form 3a (page 4), Class of Restriction with Barrier Codes, write the list numbers under the Disallowed List Access heading for each barrier code.

Call Restriction Summary

After the individual telephone forms have been completed, Form 6g, Call Restriction Assignments and Lists, can be used as a summary and telephone programming aid for telephone calling restrictions as designated in this chapter.

Planning Form Instructions

On Form 6g:

1. In the Ext. No. column, do *one* of the following:
 - Transfer the extension number from the individual telephone forms.
 - If copying from another extension, write the new extension number and then, in the Copy From column, write the extension from which calling restrictions for this extension will be copied.
2. In the Restriction Type column, check the appropriate column: Out. for Outward Restriction, Toll for Toll Restriction, or No Rest. for No Restriction.
3. In the Allowed List No. and Disallowed List No. columns, write the appropriate list numbers from Forms 6e and 6f, respectively.
4. In the ARS Restriction Levels (FRL) column, write the Facility Restriction Level (FRL) value noted in the ARS Restriction Level heading on Form 6g.

Night Service

Use these instructions only if Night Service is used for after-hours telephone operation. Otherwise, skip to the next section, "Labeling." This section contains instructions for selecting any combination of the following options for Night Service:

- Night Service with Group Assignment
- Night Service with Outward Restriction
- Night Service with Time Set

Night Service with Group Assignment

This section contains instructions for setting Night Service so that any call that comes to the operator console while Night Service is in effect rings immediately at each available telephone in a defined group and/or at a designated calling group. Calls ring immediately even on lines/trunks set for Delay Ring or No Ring.

You can create up to eight Night Service groups and/or Night Service calling groups, one for each operator. There is no limit to the number of telephones assigned to each Night Service group, and each telephone can be assigned to more than one Night Service group.

A calling group can be the Night Service group for more than one operator, but only one calling group is allowed for each operator.

A DID call directed to a calling group will not receive Night Service treatment.

Planning Form Instructions

In each column on Form 9a, Night Service: Group Assignment, do the following:

NOTE:

If the system includes AUDIX Voice Power/Fax Attendant System with Integrated Administration, fill in the extension number for each operator who will use Night Service with it; fill in the calling group number for Automated Attendant. The information will be programmed using Integrated Administration.

1. In the Operator Ext. No. space, write the extension number for the operator whose calls are being answered (see Form 2a).
2. In the Ext. or Calling Group No. column, write the extension number for each member of the Night Service group or for a Calling Group (see Form 2a).
3. In the User or Calling Group Name column, write each Night Service group member's name or the name of the Calling Group (see Form 2a).

Night Service with Outward Restriction

This section contains instructions for setting Night Service so that only authorized users can place non-emergency calls when Night Service is in effect. This prevents unauthorized after-hours use of telephones.

Calls to non-emergency numbers do not go through unless a password is entered first. You can include up to 10 telephone numbers on the Night Service Emergency List. Each number can have a maximum of 12 digits.

Once you specify that a password is required, the password applies to all telephones in the system when Night Service is activated at any operator position.

If users need to make after-hours calls and prefer not to enter a password, you can set up an Exclusion List that exempts those people's extensions from the password requirement. Extensions assigned to the Exclusion List keep the normal calling restrictions, if any are assigned, when Night Service is in effect. However, these extensions are not protected in any other way from unauthorized after-hours use.

Planning Form Instructions

On Form 9b, Night Service: Outward Restriction:

1. The password must be 4 digits and can include the numbers 0 to 9 in any combination. To keep the password private, record it on a separate paper and not on the form.



SECURITY ALERT:

Additional steps must be taken to maintain security on ports (such as Disallowed Lists, Outward Restriction, and so on). Refer to Appendix A, "Customer Support Information" for more information.

2. Write the numbers to be included in the Telephone No. list in the Emergency Allowed List section.

NOTE:

All AUDIX Voice Power and Fax Attendant System extensions are automatically included in the Exclusion List by Integrated Administration. However, to keep a record of these, you may choose to review Form 2a and, for all extensions listed for these systems, copy the extension number to this list.

3. To exclude users from the password requirement, complete the Exclusion List section.
 - a. In the Ext. No. column, write the extension number for each telephone (see Form 2a).
 - b. In the Name column, write each user's name (see Form 2a).

Night Service with Time Set

This section contains instructions for setting the system to automatically turn Night Service on and off at the times and on the days of the week you specify. This ensures that after-hours calls are handled properly even if an operator forgets to turn on Night Service. Operators can still override the timer and turn Night Service on or off manually. The feature can also be deactivated through system programming for special conditions, such as a midweek holiday.

Planning Form Instructions

On Form 9c, Night Service: Time Set, write the time of day you want Night Service turned on (Start Time) and off (Stop Time) for each day of the week. Use 24-hour numbering, called military time; for example, 5:30 p.m. is 1730 in 24-hour numbering.

If Night Service is to remain on throughout the day, for example on Sunday, do not enter on and off times.

Labeling

Labeling enhances the capability of display telephones used with the system. The following types of labels appear on display telephones:

- Extensions and calling groups
- Posted Messages
- System Directory/System Speed Dial

Labels for extensions are described in Chapter 2, "Control Unit Configuration," labels for lines/trunks are described in Chapter 4, "Features," and labels for calling groups are described earlier in this chapter.

This section contains instructions for assigning labels for Posted Message and System Directory/System Speed Dial.

Posted Message

This section contains instructions for allowing users to post a message telling callers who have display telephones why they cannot answer.

There can be as many as 20 messages. Messages 1 through 10, shown on Form 10a, are already programmed in the system, and 10 more can be added, for a total of 20. In a Release 2.0 or later system, Messages 2 through 9 can be changed. In a Release 1.0 or 1.1 system, all 10 of the preprogrammed messages can be changed.

Planning Form Instructions

Posted messages can contain as many as 16 characters, including capital letters, numbers, ampersand (&), dash (-), space, colon (:), asterisk (*), and pound sign (#).

On Form 10a, Label Form: Posted Message, do *one* of the following:

- To add posted messages for Messages 11 through 20 (for example, CUSTM MSG 11) write each new message next to its message number (11 through 20) in the Revised Message column.
- To change existing messages, cross out the message and write the new message in the Revised Message column.

NOTE:

In Release 2.0 and later, Message 1, DO NOT DISTURB, cannot be changed.

System Speed Dial

This section contains instructions for designating systemwide, frequently used numbers. You can assign and store up to 130 three-digit System Speed Dial codes. To call one of these numbers, a caller presses the **Feature** button and dials a three-digit code.

Assign System Speed Dial codes to telephone numbers that shouldn't be displayed on telephones, such as access codes. Entries that do not display are referred to as Marked System Speed Dial entries. You can also assign labels to the System Speed Dial codes. These labels are listed in the System Directory so that MLX telephone users can search for them and dial System Speed Dial numbers with the touch of a button.

Planning Form Instructions

As a visual aid to distinguish lines during programming, every fourth line on the form is shaded.

1. Review the analysis of question 9 on the Employee Communication Survey.
2. On Form 10b, System Speed Dial:
 - a. Write the label (maximum: 11 characters) to be displayed for the number in the Name column.
 - b. Write each telephone number (maximum: 40 digits) in the Telephone Number column.
 - c. To display no number (Marked System Speed Dial entry), check the No box in the Display column (the factory setting is Yes).

NOTE:

Marked System Speed Dial entries (entries that do not display) are not affected by the Second Dial Tone Timer setting. If the Central Office does not immediately supply dial tone when a star code is entered and a Marked System Speed Dial entry uses star codes, then the appropriate number of pauses (each 1.5 seconds) must be programmed in the entry following each star code.

Automatic Route Selection (Hybrid/PBX Only)



SECURITY ALERT:

ARS should always be used for the best security protection.

This section contains instructions for using Automatic Route Selection (ARS) to allow the most cost-effective use of lines/trunks connected to the system, which can mean significant savings for the customer's business. Routing calls efficiently is especially important when the business has several different types of lines/trunks, such as local, WATS, FX, or tie, or uses more than one long-distance company. If the system is pooled, you can use ARS to specify which trunk pool should be used for each call, based on the telephone number the caller dials.

With ARS, users must dial a 1 before dialing any 10-digit toll number, even if the local telephone company does not require a toll-call prefix.

You can define up to 16 ARS tables, each divided into two *subpatterns* based on the time of day. Four additional tables are factory set and are designed to save programming time.

In this section, you define a set of ARS tables. This set includes a list of area codes and exchanges associated with each table, the preferred and alternate routes (if any) for each subpattern, and the Facility Restriction Level (FRL) for each route. As the system manager becomes more familiar with the calling patterns of the company and with the intricacies of ARS, he or she may want to change these patterns to suit the particular installation.

ARS Worksheet

This section contains instructions for completing the ARS worksheet (Form 3e) to decide how to best route calls.

For each trunk pool, you identify the trunk pool number, type of trunk (local, FX, regional WATS, and so on), whether the calls are toll or local calls, and the number of area codes or exchanges the pool should serve.

When placing a toll call using ARS, callers dial one of the following:

- **11 Digits.** 1 + 3 (area code) + 3 (exchange) + 4 (last 4 digits of the number)
- **8 Digits.** 1 + 3 (exchange) + 4 (last 4 digits of the number)
- **7 Digits.** 3 (exchange) + 4 (last 4 digits of the number)

Keep in mind that for 10-digit toll calls, callers must dial 1 before dialing the area code, even if they don't normally need to dial a prefix to make a toll call.

Figure 4–1 provides a sample of a completed ARS worksheet.

Planning Form Instructions

1. Review Form 2c, System Numbering: Line/Trunk Jacks, for the types of lines/trunks available.
2. Record the number of exchanges in the local calling area in the blank at the top of Form 3e, Automatic Route Selection Worksheet. If you are not sure how many exchanges there are, consult the telephone directory.
3. Enter the number of each of the trunk pools (factory setting is 70 or 890–899) in the Trunk Pool No. column.

Some trunk pools, such as in-state WATS trunk pools, can be used for both toll and local calls. (Note that with ARS a local call is any call that doesn't require dialing a 1.)

If you expect people to use a particular trunk pool for both toll and local calls, enter the number of that trunk pool in the worksheet twice, and note the reason.

4. For each trunk pool number entered:
 - a. In the Trunk Type column, record the type of trunk (local, FX, regional WATS, and so on) that is in the pool.
 - b. Under the Type of Dial heading, check the appropriate column (Toll or Local) for the type of call that should be dialed on each trunk pool:
 - **Toll.** Any call that has a series of digits beginning with a 1, followed by an exchange or area code.
 - **Local.** Any call that is not a toll call. This includes the seven-digit dialed numbers required in most areas.
 - c. Enter the total number of different area codes or exchanges that the pool should serve in the Number of Area Codes or Exchanges for which Trunk Pool Is Used column.

If you do not know the exact number of exchanges or area codes, write a note such as **All area codes in the U.S. except the 15 served by the regional WATS lines/trunks.** Keep in mind that you're recording how many different area codes or exchanges the pool should access, not the area codes or exchanges themselves. This step helps identify the preferred trunk pools for toll and local calls. (*Preferred pools* are the trunk pools in which the system places each call unless a different route has been specified for that particular type of call.)

5. Under the Preferred Trunk Pools heading:
 - a. Determine which of the toll trunk pools is used for calls to the greatest number of different area codes. Write the number of that trunk pool in the space next to For toll calls (Table 17).
 - b. Determine which of the local trunk pools is used for calls to the greatest number of different exchanges. Write the number of that trunk pool in the space next to For local calls (Table 18).

NOTE:

Tables 17 and 18 are explained later.

Figure 4-1 shows the completed Automatic Route Selection Worksheet for the fictitious company, McHale and Associates of Denver, Colorado (area code: 303). McHale has a local trunk pool, an in-state WATS pool, and a cross-country WATS pool. Because Colorado has two area codes (303 and 719), the in-state WATS line/trunk can be used for both toll and local calls. Therefore, there are two entries for Pool 890 on the worksheet.

The cross-country WATS trunk pool serves the greatest number of different area codes, every area code in the country except the two in Colorado. Therefore, it is the preferred trunk pool for toll calls.

The in-state WATS trunk pool serves the greatest number of different exchanges. It is the preferred trunk pool for calls to every exchange in area code 303, except the 20 exchanges in the local calling area. Therefore, it is the preferred trunk pool for local calls and some of these are toll calls.

Automatic Route Selection Tables

This section contains instructions for using the information you recorded on the worksheet to prepare the ARS tables. The system can have as many as 20 ARS tables—16 are programmed and 4 are factory set (Dial 0, Special Number, Default Local, and Default Toll tables). Of the 16 programmable tables, each may contain one of the following types of information:

- **6-Digit Tables.** If the cost of calls to another area code varies according to the exchange, this table can be used to route calls on different trunk pools, depending on both the area code and the exchange. An area code is the first entry, and the remaining 99 entries are exchanges within the area code. The system scans the first 6 digits of the user-dialed number (area code and exchange) to route the call.
- **Area Code Tables.** These tables are lists of 3-digit area codes. Area code tables are useful if just one type of line/trunk is used for all calls to each area code on the list.
- **Local Exchange Tables.** These tables list 3-digit exchanges within the local area code. They can be used to route calls over in-state WATS.
- **1+7 Tables.** These tables contain a list of exchanges within the local area code that require dialing a **1** but not an area code before the 7 digits.

Because ARS routing requires care and planning, the instructions for filling out the planning forms are presented a few steps at a time with examples of completed forms shown after each group of steps. The instructions begin with the programmable tables (1 through 16) and introduce the factory-set tables midway through the process.

Planning Form Instructions

Complete Form 3f for each trunk pool listed on the ARS worksheet (Form 3e).

NOTE:

The digits before the blank lines in the Area Code/Exchanges section represent the table entry number used during programming.

On each copy of Form 3f:

1. Write the table number in the Table No. space (maximum 16). Start with the number 1 and proceed sequentially.
2. Check the appropriate box under the Type of Table heading: 6-Digit, Area Code, Exchange, or 1+7.

3. Do *one* of the following:
 - If this is *not* a 1+7 table, skip to Step 4.
 - If this is a 1+7 table, do *one* of the following:
 - If users do *not* need to dial a 1 to reach numbers within their own area code, check the not within area code box (factory setting).
 - If users need to dial a 1 to reach numbers within their own area code, check the within area code box.
4. Complete the Area Code/Exchanges section by doing *one* of the following:
 - If this is a 6-digit table, write the area code on the blank line next to entry 001. Then write each exchange to be called in that area code. Use the numbered lines, beginning with entry 002.

Up to 99 exchanges can be listed in any order. If you need to list another area code with exchanges, prepare another 6-digit table.
 - If this is an Area Code, Exchange, or 1+7 table, write the area codes or exchanges on the numbered lines, beginning with entry 001.

Up to 100 area codes or exchanges can be listed in any order, but area codes and exchanges cannot be on the same table.

Example 1. If a business plans to use Table 1 to route calls to exchanges 333, 444, and 523 in area code 816, the upper section of the completed Form 3f will look similar to Figure 4–2.

Example 2. If the business plans to use Table 7 to route calls to the northeastern (band 1) WATS lines/trunks as entries 001 through 015, the upper section of the completed form will look similar to the one shown in Figure 4–3.

Form 3f

Automatic Route Selection Tables*

Maximum: 16 Tables. (Make a copy for each table.)

Table No. 4

Type of Table

- 6-Digit
- Area Code
- Exchange
- 1 + 7, dialing from
 - within area code
 - not within area code ♦

Area Code/Exchanges

001 <u>901</u>	021 _____	041 _____	061 _____	081 _____
002 <u>686</u>	022 _____	042 _____	062 _____	082 _____
003 _____	023 _____	043 _____	063 _____	083 _____
004 _____	024 _____	044 _____	064 _____	084 _____
005 _____	025 _____	045 _____	065 _____	
006 _____	026 _____	046 _____		095 _____
007 _____	027 _____		076 _____	096 _____
008 _____	028 _____	057 _____	077 _____	097 _____
009 _____		058 _____	078 _____	098 _____
010 _____	039 _____	059 _____	079 _____	099 _____
	040 _____	060 _____	080 _____	100 _____

Subpattern A Time of Day					Subpattern B Time of Day				
Pool	FRL (3 ♦)	Other Digits	Absorb	Call Type [†]	Pool	FRL (3 ♦)	Other Digits	Absorb	Call Type [†]
1 <u>893</u>	_____	_____	1 <u>4</u>	<u>V</u>	1 _____	_____	_____	1 _____	_____
2 _____	_____	_____	2 _____	_____	2 _____	_____	_____	2 _____	_____
3 _____	_____	_____	3 _____	_____	3 _____	_____	_____	3 _____	_____
4 _____	_____	_____	4 _____	_____	4 _____	_____	_____	4 _____	_____
5 _____	_____	_____	5 _____	_____	5 _____	_____	_____	5 _____	_____
6 _____	_____	_____	6 _____	_____	6 _____	_____	_____	6 _____	_____

♦ Factory Setting
 * Hybrid/PBX mode only
[†] Select Voice only, Data only, or Both.

Figure 4-2. Example 1: Form 3f, 6-Digit Table

Automatic Route Selection Tables*

Maximum: 16 Tables. (Make a copy for each table.)

Table No. 7

Type of Table

- 6-Digit
- Area Code
- Exchange
- 1 + 7, dialing from
 - within area code
 - not within area code ◆

Area Code/Exchanges

001 <u>413</u>	021 _____	041 _____	061 _____	081 _____
002 <u>617</u>	022 _____	042 _____	062 _____	082 _____
003 <u>203</u>	023 _____	043 _____	063 _____	083 _____
004 <u>508</u>	024 _____	044 _____	064 _____	084 _____
005 <u>401</u>	025 _____	045 _____	065 _____	085 _____
006 <u>516</u>	026 _____	046 _____	066 _____	086 _____
007 <u>518</u>	027 _____	047 _____	067 _____	087 _____
008 <u>914</u>	028 _____	048 _____	068 _____	088 _____
009 <u>717</u>	029 _____	049 _____	069 _____	089 _____
010 <u>201</u>	030 _____	050 _____	070 _____	090 _____
011 <u>603</u>	031 _____	051 _____	071 _____	091 _____
012 <u>207</u>	032 _____	052 _____	072 _____	092 _____
013 <u>215</u>	033 _____	053 _____	073 _____	093 _____
014 <u>802</u>	034 _____	054 _____	074 _____	
015 <u>609</u>	035 _____	055 _____		
016 _____	036 _____			
017 _____	037 _____			
018 _____				
019 _____				

Figure 4-3. Example 2: Form 3f, Area Code Table

Subpatterns

For each table (1 through 16, and factory-set Tables 17 and 18), you can select two subpatterns (A and B) that specify routes to be used at different times. You can specify up to six routes for each subpattern. For example, you may want calls to certain area codes routed over WATS lines/trunks during the day; after 11 p.m., when toll rates are less expensive on basic lines/trunks, you may want the calls routed over the main pool.

For each of the 12 routes (six for each subpattern), you can specify a Facility Restriction Level (FRL). The FRL is used to refine the route selection process still further. Each route is assigned an FRL from 0 through 6 (6 is the most restricted). Each telephone is also assigned an FRL from 0 through 6 (0 is the most restricted). Callers (extension or remote access barrier code/trunk) can use the route only if their FRL is equal to or greater than that specified for the route. You assign a value of 0 to the route if you want all users to access the route, or 1 through 6 to restrict calling for the route to specific users only.

The form for a typical Area Code Table, illustrated in Figure 4–4, shows a table to route calls to the 13 area codes served by the northeastern (band 1) WATS lines beginning at 8 a.m. with no restrictions. The number of the northeastern WATS pool, 891, is on the first line in the Subpattern A section. The time, 8:00 a.m., is in the Time of Day space, and an FRL of 0 indicates no restrictions. The 11 p.m. in the Time of Day space for Subpattern B and Pool 70 in the Pool column indicates that calls to these area codes are to be routed over the main pool after 11 p.m.

Planning Form Instructions

In the Subpattern sections on Form 3f and Form 3g:

1. To direct calls differently according to time of day, write a starting time for each subpattern in the Time of Day space (for example, 8 a.m.).
2. To complete the Pool column for each subpattern, write the number of the preferred trunk pool next to the number 1. This is the pool to which calls to the area codes or exchanges listed in the Area Code/Exchanges section of this form should be directed.

If you want to designate a backup pool in case all the lines/trunks in the first choice pool are busy, write the number of the backup trunk pool next to the number 2, and so on.

3. To complete the FRL column, enter a value of 0 through 6. Assign a value of 0 if you want all users to access the route, or 1 through 6 to restrict calling for the route to specific users only. For all except the Default Local Table, the factory setting is 3. The Default Local Table factory setting is 2.

4. If extra digits at the beginning of the dialed number may be required for the system to place a call on a particular pool, enter the digits (0 through 9) in the same row as the pool number, in the column under the Other Digits heading. (See the Other Digits example below, in Figure 4-5.)

These special access or account codes can range from a single digit, such as 9, to a maximum of 20 digits.

Because calls to the 15 area codes shown on Figure 4-4 should be placed on the cross-country WATS lines/trunks when all the northeastern WATS lines/trunks are busy, the number of the cross-country WATS pool, 890, is used in both cases. An FRL of 4 is assigned to restrict some users from using cross-country WATS lines/trunks.

Example. If a business uses a different long-distance company for calls to nine area codes in Canada, accessing the alternate long-distance company lines requires getting a local line and dialing seven digits. The completed form for the Area Code Table that routes these calls to the alternate long-distance company lines is shown in Figure 4-5.

Form 3f
Automatic Route Selection Tables*

Maximum: 16 Tables. (Make a copy for each table.)

Table No. 2

Type of Table

- 6-Digit
- Area Code
- Exchange
- 1 + 7, dialing from
 - within area code
 - not within area code ◆

Area Code/Exchanges

001 <u>413</u>	021 _____	041 _____	061 _____	081 _____
002 <u>617</u>	022 _____	042 _____	062 _____	082 _____
003 <u>203</u>	023 _____	043 _____	063 _____	083 _____
004 <u>508</u>	024 _____	044 _____	064 _____	084 _____
005 <u>401</u>	025 _____	045 _____	065 _____	085 _____
006 <u>516</u>	026 _____	046 _____	066 _____	095 _____
007 <u>518</u>	027 _____	047 _____	076 _____	096 _____
008 <u>914</u>	028 _____	057 _____	077 _____	097 _____
009 <u>717</u>	029 _____	058 _____	078 _____	098 _____
010 <u>201</u>	039 _____	059 _____	079 _____	099 _____
011 <u>603</u>	040 _____	060 _____	080 _____	100 _____

Subpattern A Time of Day <u>8:00 am</u>					Subpattern B Time of Day <u>11:00 pm</u>				
Pool	FRL (3 ◆)	Other Digits	Absorb	Call Type ¹	Pool	FRL (3 ◆)	Other Digits	Absorb	Call Type ¹
1 <u>891</u>	<u>0</u>	_____	1 _____	<u>V</u>	1 <u>70</u>	<u>0</u>	_____	1 _____	<u>V</u>
2 <u>890</u>	<u>4</u>	_____	2 _____	<u>V</u>	2 <u>890</u>	<u>4</u>	_____	2 _____	<u>V</u>
3 _____	_____	_____	3 _____	_____	3 _____	_____	_____	3 _____	_____
4 _____	_____	_____	4 _____	_____	4 _____	_____	_____	4 _____	_____
5 _____	_____	_____	5 _____	_____	5 _____	_____	_____	5 _____	_____
6 _____	_____	_____	6 _____	_____	6 _____	_____	_____	6 _____	_____

◆ Factory Setting
 * Hybrid/PBX mode only
¹ Select Voice only, Data only, or Both.

Figure 4-4. Subpattern Example

Form 3f

Automatic Route Selection Tables*

Maximum: 16 Tables. (Make a copy for each table.)

Table No. 3

Type of Table

- 6-Digit
- Area Code
- Exchange
- 1 + 7, dialing from
 - within area code
 - not within area code ♦

Area Code/Exchanges

001 <u>604</u>	021 _____	041 _____	061 _____	081 _____
002 <u>403</u>	022 _____	042 _____	062 _____	082 _____
003 <u>306</u>	023 _____	043 _____	063 _____	083 _____
004 <u>204</u>	024 _____	044 _____	064 _____	084 _____
005 <u>807</u>	025 _____	045 _____	065 _____	
006 <u>705</u>	026 _____	046 _____		
007 <u>519</u>	027 _____			
008 <u>416</u>	028 _____			
009 <u>613</u>		057 _____	076 _____	095 _____
010 _____		058 _____	077 _____	096 _____
	039 _____	059 _____	078 _____	097 _____
	040 _____	060 _____	079 _____	098 _____
			080 _____	099 _____
				100 _____

Subpattern A Time of Day _____					Subpattern B Time of Day _____				
Pool	FRL (3 ♦)	Other Digits	Absorb	Call Type [†]	Pool	FRL (3 ♦)	Other Digits	Absorb	Call Type [†]
1	<u>70</u>	<u>905012</u>	1 _____	<u>V</u>	1	_____	_____	1 _____	_____
2	_____	_____	2 _____	_____	2	_____	_____	2 _____	_____
3	_____	_____	3 _____	_____	3	_____	_____	3 _____	_____
4	_____	_____	4 _____	_____	4	_____	_____	4 _____	_____
5	_____	_____	5 _____	_____	5	_____	_____	5 _____	_____
6	_____	_____	6 _____	_____	6	_____	_____	6 _____	_____

♦ Factory Setting
 * Hybrid/PBX mode only
[†] Select Voice only, Data only, or Both.

Figure 4-5. Other Digits Example

5. If the system must absorb certain leading digits dialed by users to place calls on a particular pool, enter a number in the same row as the pool number, in the Absorb column.

Use the number 0 if you do not want absorption. Assign a value of 1 through 11 according to the number of digits you want absorbed, starting with the first digit dialed.

Example. If a company has FX lines/trunks for the 686 exchange in the 901 area code and wants to allow people to dial those calls the same way they dial toll calls to other area codes, an absorption number of 4 is assigned to the FX trunk pool, Pool 893. The completed form for the 6-Digit Table that routes calls to the FX trunk pool is shown in Figure 4–6.

After ARS is programmed, people in the Figure 4–6 company dial 1-901-686-XXXX to make these calls. The system absorbs the leading 1 and the area code and dials only the seven-digit number to place these calls on one of the FX lines/trunks.

Form 3f

Automatic Route Selection Tables*

Maximum: 16 Tables. (Make a copy for each table.)

Table No. 4

Type of Table

- 6-Digit
- Area Code
- Exchange
- 1 + 7, dialing from
 - within area code
 - not within area code ♦

Area Code/Exchanges

001 <u>901</u>	021 _____	041 _____	061 _____	081 _____
002 <u>686</u>	022 _____	042 _____	062 _____	082 _____
003 _____	023 _____	043 _____	063 _____	083 _____
004 _____	024 _____	044 _____	064 _____	084 _____
005 _____	025 _____	045 _____	065 _____	_____
006 _____	026 _____	046 _____	_____	095 _____
007 _____	027 _____	_____	076 _____	096 _____
008 _____	028 _____	057 _____	077 _____	097 _____
009 _____	_____	058 _____	078 _____	098 _____
010 _____	039 _____	059 _____	079 _____	099 _____
_____	040 _____	060 _____	080 _____	100 _____

Subpattern A Time of Day					Subpattern B Time of Day				
Pool	FRL (3 ♦)	Other Digits	Absorb	Call Type [†]	Pool	FRL (3 ♦)	Other Digits	Absorb	Call Type [†]
1 <u>893</u>	_____	_____	1 <u>4</u>	<u>V</u>	1 _____	_____	_____	1 _____	_____
2 _____	_____	_____	2 _____	_____	2 _____	_____	_____	2 _____	_____
3 _____	_____	_____	3 _____	_____	3 _____	_____	_____	3 _____	_____
4 _____	_____	_____	4 _____	_____	4 _____	_____	_____	4 _____	_____
5 _____	_____	_____	5 _____	_____	5 _____	_____	_____	5 _____	_____
6 _____	_____	_____	6 _____	_____	6 _____	_____	_____	6 _____	_____

♦ Factory Setting

* Hybrid/PBX mode only

[†] Select Voice only, Data only, or Both.

Figure 4-6. Digit Absorption Example

6. To complete the Call Type column, enter *one* of the following:
 - For voice only calls, write **V**.
 - For data only calls, write **D**.
 - For both voice and data calls, write **V/D**.
7. If you have worked on only one of your planned non-default tables, complete all copies of Form 3f. Repeat Steps 1 through 6 for each table (Tables 1 through 16) that you need.
8. If you have not completed the factory-set tables, do so now:
 - a. For Tables 17 (Default Toll) and 18 (Default Local), repeat Steps 1 through 6 to complete the subpattern and pool routing sections.
 - b. For the Dial 0 table (Table 19) complete the Pool routing, Facility Restriction Level (FRL) and Other Digits entries following Steps 2 through 4.



WARNING:

In the next step, assigning a restrictive FRL could impair the ability to dial 911.

- c. If users need to dial an access code to call the special numbers 411, 611, 811, and 911, record that code on the Special Number Table (20), under the Other Digits heading. Assign the FRL as shown in Step 3.
9. If restricting extensions and remote access users from specific routes, locate Form 6g, Call Restriction Assignments and Lists:
 - a. Under the ARS Restriction Level heading on each telephone form, write the value (0 to 6) you want to assign.
 - b. Under the ARS Restriction Level heading on pages 3 and 4 of Form 3a, check the value (0 to 6) you want to assign.

Extension and Remote Access FRL values must be equal to or greater than the FRL value assigned to routes in order for users to access those routes. A value of 0 is the most restrictive, and a value of 6 is the least restrictive. The factory-set FRL value assigned to extensions is 3.

To restrict an extension from specific routes, assign an FRL value to the extension that is lower than the route's value.

For example, if you want to limit a user from making calls on pools with special-use lines/trunks such as WATS, assign a value of 0. If you want a telephone used by a top executive to have unlimited use of any ARS route, assign a value of 6.

Contents

Terminology	5-2
About Data and Video Communications	5-4
■ Connectivity	5-4
■ Data Stations	5-5
Modem Data Stations	5-6
Analog Voice and Modem Data	5-7
Modem Data-Only	5-8
MLX Voice and Modem Data	5-9
ISDN Terminal Adapter Data Stations	5-10
MLX Voice and ISDN Terminal Adapter Data	5-11
ISDN Terminal Adapter Data-Only	5-12
■ Summary of Data Station Configurations	5-13
■ Other Supported Data Terminals	5-14
■ Other Resource Groups	5-14
■ Data Hunt Groups	5-15
Data Hunt Group Configurations	5-15
■ Video Systems	5-15
Personal Videoconferencing	5-16
Passive Bus Configuration	5-16
Group Videoconferencing	5-17
Planning Overview	5-19
Assigning Extension Jacks	5-21
■ Guidelines for Digital Extension Jacks	5-22
■ Modem Data-Only Stations	5-23
■ ISDN Terminal Adapter Data-Only Stations	5-23
■ Local Host Computer Data Stations	5-23
■ LAN Workstations	5-24
■ Video Systems	5-25

Contents

Assigning Lines/Trunks to Data and Video Stations	5-26
■ Assigning Line Buttons in Hybrid/PBX Mode	5-30
■ Assigning Pools and Lines/Trunks (Hybrid/PBX Mode)	5-32
■ Assigning Line Buttons in Key Mode	5-33
Assigning Features to Data Stations	5-34
■ Pool Dial-Out Code (Hybrid/PBX Only)	5-36
■ Calling Restrictions	5-37
■ Forced Account Code Entry	5-37
■ ARS Facility Restriction Level	5-38
■ System Speed Dial Codes	5-38
Creating Data Hunt Groups	5-39
■ Guidelines	5-39
Digital Data/Video Stations	5-41

In addition to voice communications capabilities, the system also supports data and video communications to enable users to send or receive data, or establish group or personal video conferences.

Planning for data and video communications consists of the following tasks:

1. Planning how the data and/or video equipment connects to extension jacks on the control unit. This depends on the type of data stations or video systems.
2. Creating modem/ISDN terminal adapter pools (pairs of modems and ISDN terminal adapters) to enable calls between the two types of data stations: modem data stations and ISDN terminal adapter data stations.
3. Assigning lines/trunks to data stations and video systems.
4. Assigning features to data stations.
5. Creating data hunt groups (DHGs), that is, data calling groups, if there are modem/ISDN terminal adapter pools with more than one data communications equipment pair (a modem and an ISDN terminal adapter), or to designate a group of either modems or ISDN terminal adapters to receive calls to communicate with a local host computer or LAN workstation.

NOTE:

Modem/ISDN terminal adapter pools are not described in this book. For information see application note, *MERLIN LEGEND Communications System Modem Pooling*.

6. Configuring MLX jacks for 2B Data (2 B-channel) connectivity. This allows video systems to use both B-channels on a single MLX jack to establish high-speed full-motion video connections at data rates of up to 128-kbps.

NOTE:

For additional information on 2B Data/Video and for information on connecting video systems to the MERLIN LEGEND system, refer to the *Data and Video Reference*.

For information on ordering desktop video equipment, refer to Marketing Announcement Letter *GBCS-96-05-001 Multi-Vendor Desktop Videoconferencing Offer*.

When using the 008 MLX or 408 GS/LS-MLX module for data or video, you must use Version 28 of the module.

Following an explanation of the terminology used in this chapter and an overview of data communications, this chapter contains instructions for planning data and video communications. Some procedures involve making additional entries on the forms already completed earlier in this guide; others involve filling out data forms as described in "Planning Overview," later in this chapter.

For detailed information about the system's data communications capabilities, see the *Equipment and Operations Reference*. Instructions for using the data and video communications capabilities are contained in *Data and Video Reference*.

Terminology

The following terms are used in this chapter:

- **Data Station.** A hardware configuration used to send and receive data (and sometimes voice signals, depending on the equipment). The configuration includes data terminal equipment (DTE) for input and output of data, and data communications equipment (DCE) to enable the transmission of data over digital or analog telephone lines and trunks. There are two types of data stations:
 - **Modem Data Stations.** Connect to the control unit through an analog extension jack or a T/R jack and require a modem. Analog data stations can support analog data and analog voice, analog data only, or analog data and MLX voice.
 - **ISDN Terminal Adapter Data Stations.** Connect to the control unit through an MLX extension jack and require an ISDN terminal adapter (such as the ExpressRoute 1000 or ISDN 7500B data module). ISDN terminal adapter data stations can support ISDN terminal adapter data and MLX voice or ISDN terminal adapter data only.
- **Data Terminal Equipment (DTE).** Data station equipment, for example, a PC, host computer, or LAN workstation, from which data is input and/or output. DTE, which can also be referred to as a data terminal, uses data communications equipment (DCE) to transmit and receive the digital signals it requires.

- **Data Communications Equipment (DCE).** Data station equipment that enables the transmission of data over digital or analog telephone lines and trunks. DTE requires DCE as follows:
 - **Modem.** A type of data communications equipment that converts the DTE's outgoing digital signals into analog signals for transmission over regular (analog) telephone company lines. Another modem at the receiving data station converts the analog signals back into digital signals for reception by the DTE (for example, a PC). An analog data station uses a modem as its DCE.
 - **ISDN Terminal Adapter.** A type of data communications equipment that transmits digital signals over digital telephone company facilities, for example, PRI. A digital data station uses an ISDN terminal adapter (such as the ExpressRoute 1000 or 7500B data module) as its DCE.
- **Data Terminal.** Data station equipment (for example, a PC, host computer, LAN workstation, Group IV fax machine, or a group video conferencing installation) from which data is input and/or output. A data terminal uses data communications equipment (DCE) to transmit and receive the digital signals it requires.
- **Modem/ISDN Terminal Adapter Pool.** A special type of hardware configuration that combines one or more pairs of DCEs to enable communication between modem and ISDN terminal adapter data stations. A pair consists of one modem and one ISDN terminal adapter. Modem/ISDN terminal adapter pools are set up in one of two ways depending on the type of data station being used to *send* data: analog-to-digital or digital-to-analog. For more information about these pools, see application note, *MERLIN LEGEND Communications System Modem Pooling*.
- **Data Hunt Group (DHG).** A data calling group typically used to distribute calls to modem/ISDN terminal adapter pools that have more than one pair of DCEs. For more information about DHGs, see the application note, *MERLIN LEGEND Communications System Modem Pooling*.
- **Video System.** Equipment that allows desktop or group video conferencing. This equipment connects either directly or through an ISDN terminal adapter to an MLX jack on the MERLIN LEGEND system. If the MLX port is administered as a 2B Data port, the video systems can use both of the B-channels assigned to the MLX port to provide full-motion video. Many video applications also support data sharing and/or transfer. In some configurations, an MLX telephone may be connected in a passive bus arrangement.

NOTE:

If the video system is connected to the MLX jack through an ISDN terminal adapter, unless the ISDN terminal adapter itself supports 2B Data communications, it is recommended that the MLX port *NOT* be administered as a 2B Data port.

About Data and Video Communications

This section provides a high-level overview of the system's data and video communications capabilities, followed by more detailed information about some of the equipment and concepts introduced in this overview.

Connectivity

Data communications connectivity enables the system to share resources, as well as to establish and manage connections between computers and other data devices.

Video communications connectivity enables users to conduct personal or group video conferences and to share data and applications (also known as Video Collaboration).

The system control unit (hardware and software) in conjunction with other external hardware devices provides data and video connectivity for the following:

- On-premises analog data stations
- Connection to off-premises data stations by way of an analog line/trunk (GS, LS, Tie, or DID), by way of a dedicated analog line/trunk, or by way of a DS1 Digital Service Link providing emulated GS, LS, Tie or DID trunks
- On-premises ISDN terminal adapter data stations
- Connection to off-premises digital data stations by way of a PRI, NI-1 BRI, or T1 Switched 56 facility (including T1-Tie trunks using T1 Switched 56 service).
- Connections between two similar types of data stations
- Connection between a digital data station (on a B-channel) and an analog data station by way of 2-stage dialing through a modem/ISDN terminal adapter pool. This configuration is not described in this book; see application note, *MERLIN LEGEND Communications System Modem Pooling*.
- On-premises host computer access
- Local area network (LAN) access by way of a modem or ISDN terminal adapter connected to an RS-232 port on a workstation on the LAN
- On- and Off-premises personal or group video systems by way of a digital PRI, NI-1 BRI, or T1 Switched 56 facility (including T1-Tie trunks using T1 Switched 56 service).

Data Stations

A data station is a hardware configuration used to send and receive data (and/or voice, depending on the equipment). The configuration must include two main components: data terminal equipment (DTE) for input or output of data, along with data communication equipment (DCE) to enable the transmission of data over analog or digital lines/trunks. Depending on the station configuration, it may or may not include a telephone, either analog or an MLX telephone.

The DTE is usually a PC, but can be a host computer, a LAN workstation, a printer, an optical scanner, or a video system or other equipment used for data input and/or output.

The DCE, which is either a modem or an ISDN terminal adapter (such as the ExpressRoute 1000 or 7500B data module), allows data from the DTE to be transmitted over digital or analog telephone lines/trunks. The DCE, which has capabilities similar to a telephone, also may make the data call, maintain the connection, and terminate the data call.

NOTE:

The DCE and DTE may have hardware and/or software options that can be set for transferring and receiving data, such as parity and bit rate. For more information, refer to the DTE and DCE documentation for configuration compatibility requirements, options, and guidelines for changing options.

There are two types of data stations:

- **Modem Data Station.** This type of data station sends and receives analog data. It includes a modem as its DCE and is connected to an analog extension jack or T/R jack on the control unit.
- **ISDN Terminal Adapter Data Station.** This type of data station sends and receives digital data. It includes an ISDN terminal adapter as its DCE and is connected to a digital extension jack (MLX port) on the control unit.

Within each type, there are several configurations, depending on the station's capabilities (for example, voice and data or data only) and, therefore, what equipment is involved and what type of module they connect to on the control unit.

This section describes each type of data station and the configurations supported within each type. For more information, refer to the *Equipment and Operations Reference*.

Modem Data Stations

A modem data station uses a modem as its DCE to send and receive data.

The modem converts digital signals from the DTE at the originating station into analog signals so the data can be transmitted over analog telephone lines/trunks. At the receiving station, the modem converts the analog signals back to digital signals so the DTE at that end can accept them. A modem may provide dialing and answering capabilities for a modem data station; if not, a telephone can be connected to dial out.

NOTE:

If an analog multiline telephone is connected to the modem data station, the telephone and data station can be used at the same time. A voice call can be made or received while a data call is in progress. A data call cannot be made or received while a voice call is in progress.

A modem data station can be used to make analog data calls either over the telephone company network or to a data station inside the system.

The interface for a modem data station is the tip/ring (T/R) interface provided by one of the following:

- A General-Purpose Adapter (GPA), connected to an analog multiline telephone
- A port on a T/R module (012, 016, or 008 OPT)
- A Multi-Function Module (MFM) adjunct on an MLX telephone

There are different types of modem data stations, depending on the data station capabilities:

- Modem voice and analog data (analog voice-and-data)
- Modem data only
- Modem data and MLX voice

Each of these use different equipment as described in this section.

Analog Voice and Modem Data

This type of modem data station includes an analog multiline telephone, a modem, and a DTE (a data terminal or PC) (see Figure 5-1). The modem connects to the control unit through the T/R interface of a General-Purpose Adapter (GPA). The telephone connects to the system through an analog port on the control unit.

The port configuration requires two adjacent odd/even extension jacks on a 408, 408 GS/LS, or 008 module in the control unit. The even jack is for voice and the odd jack is for data. The bridging adapter joins the odd/even jack pair for connection to the analog multiline telephone. The telephone provides the dialing capability for the data station.

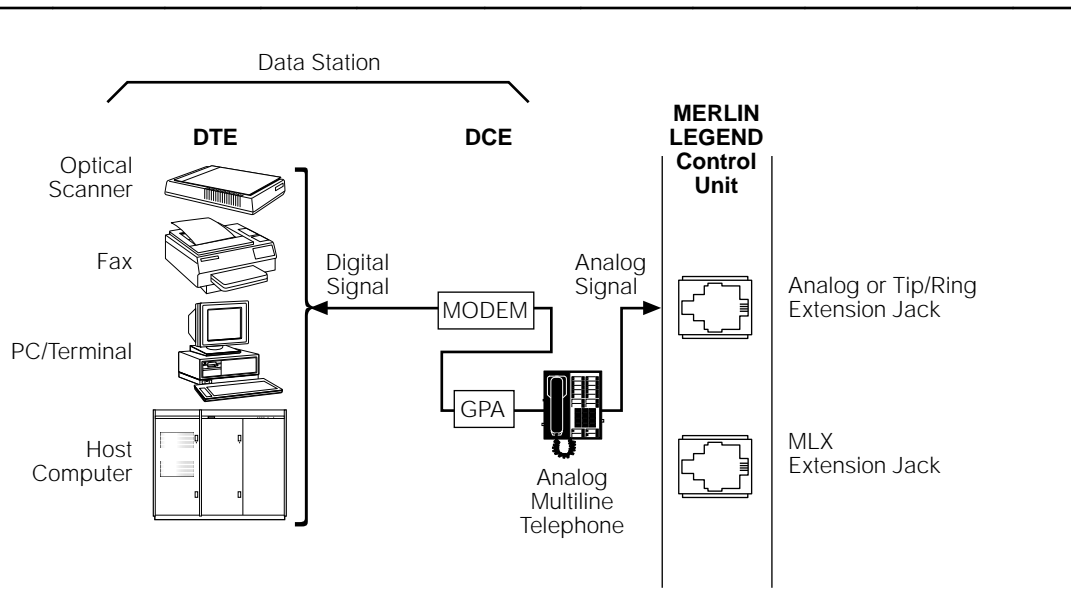

Figure 5-1. Analog Voice and Modem Data

Modem Data-Only

This type of modem data station includes only DTE and a modem (see Figure 5-2). The modem connects to the control unit through an analog port on a T/R module. If the modem does not provide dialing capability, a single-line telephone can be connected to it to provide dial-out capability; however, the data station and the telephone cannot be used simultaneously.

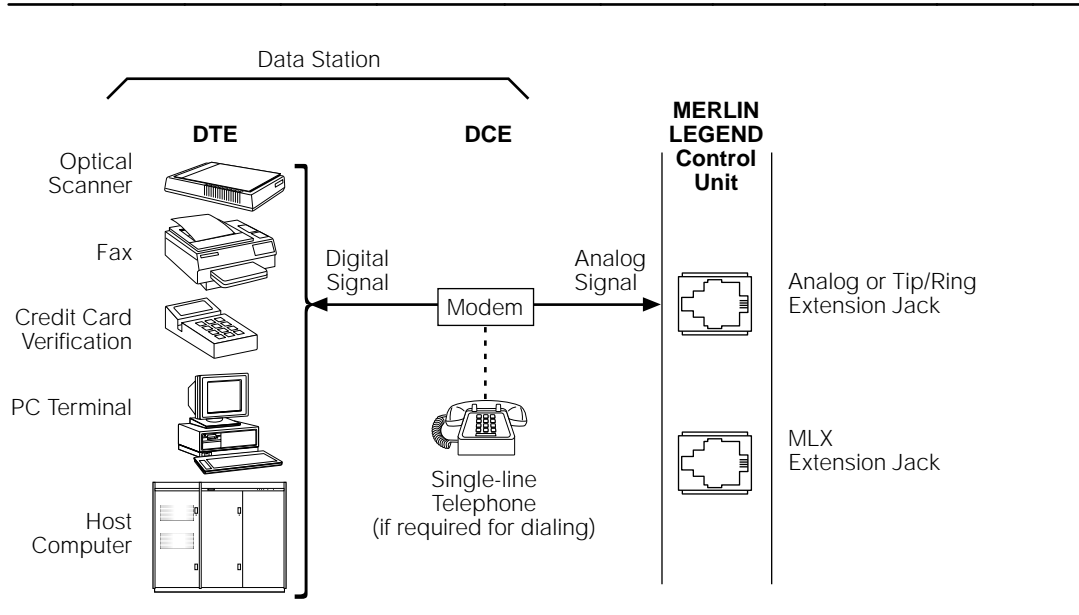

Figure 5-2. Modem Data-Only

MLX Voice and Modem Data

This type of analog data station includes an MLX telephone in addition to the DTE and modem (see Figure 5-3). The modem connects to the MLX telephone through the T/R interface of the Multi-Function Module (MFM), which is installed in the MLX telephone. The telephone connects to the control unit through an MLX extension jack. The communication capabilities of the MLX telephone and data station can be used simultaneously.

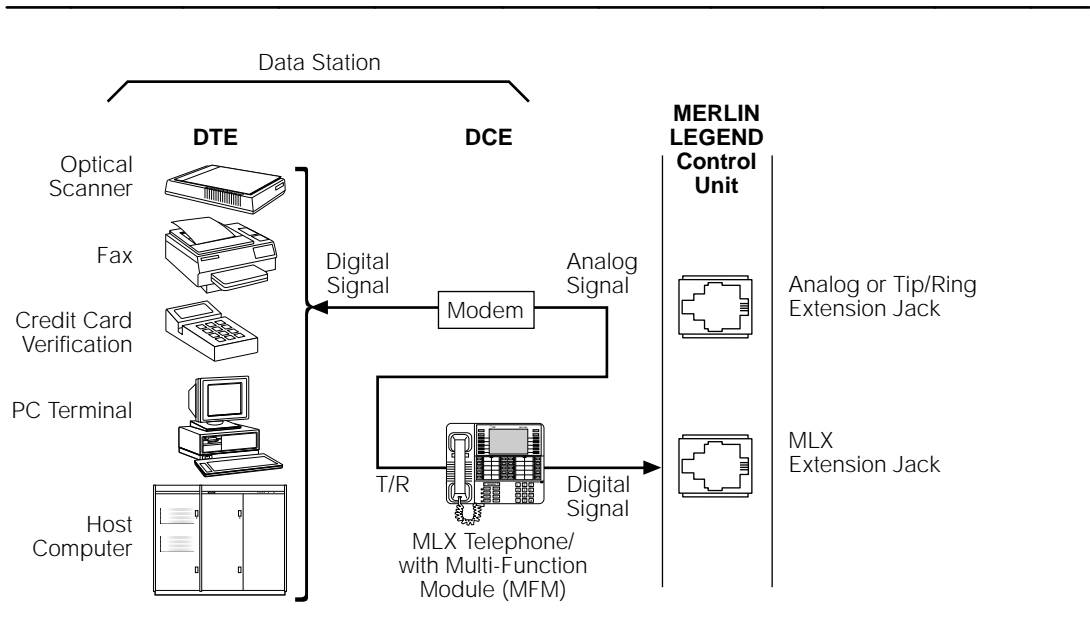

Figure 5-3. MLX Voice and Modem Data

ISDN Terminal Adapter Data Stations

An ISDN terminal adapter data station uses an ISDN terminal adapter as its DCE to send and receive data and connects to a digital extension jack (MLX port) on the control unit. If PRI, NI-1 BRI, or T1 Switched 56 facilities (including T1-Tie trunks using T1 Switched 56 service) are assigned to the MLX port, that port may be configured as a 1B Data or 2B Data port. In a 1B configuration, only one of the assigned B-channels is used by the ISDN terminal adapter data station. The 2B configuration allows the simultaneous use of both B-channels.

The ISDN terminal adapter adapts the DTE to the MLX environment. Instead of converting digital signals to analog signals as a modem does, the ISDN terminal adapter maintains a digital data format that allows transmission to another inside ISDN terminal adapter station or over the PRI, NI-1 BRI, or T1 Switched 56 telephone network.

The ISDN terminal adapter can provide dialing and answering capabilities to the data station, and can share the MLX extension jack with an MLX telephone.

An ISDN terminal adapter data station can be used to make data calls either over digital telephone facilities (PRI, NI-1 BRI, or T1 Switched 56 facilities) or to an ISDN terminal adapter data station inside the system.

There are different types of ISDN terminal adapter data stations depending on the data station's capabilities:

- MLX voice and ISDN terminal adapter data (digital voice-and-data)
- ISDN terminal adapter data-only

MLX Voice and ISDN Terminal Adapter Data

This type of ISDN terminal adapter data station includes an MLX telephone in addition to the DTE and ISDN terminal adapter (see Figure 5-4). The ISDN terminal adapter connects to the control unit through an MLX port. The MLX port is shared by both the telephone and the data station but they operate independently of each other and can be used simultaneously.

NOTE:

In an MLX voice and ISDN terminal adapter data station, the MLX telephone cannot contain an MFM.

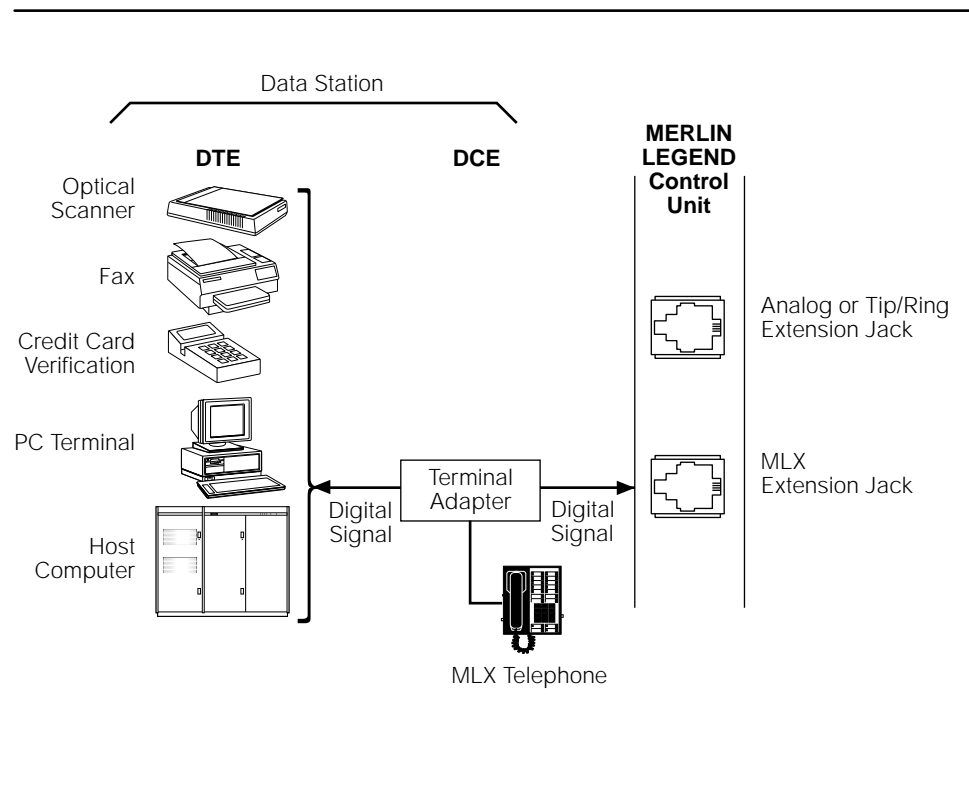

Figure 5-4. MLX Voice and ISDN Terminal Adapter Data

ISDN Terminal Adapter Data-Only

This type of digital data station includes only the DTE and ISDN terminal adapter. The ISDN terminal adapter connects the DTE to the system through an MLX extension jack on the control unit (see Figure 5-5). Since the configuration does not include an MLX telephone, if a 7500B data module is used as the ISDN terminal adapter, a 440A4 terminating resistor adapter is required.

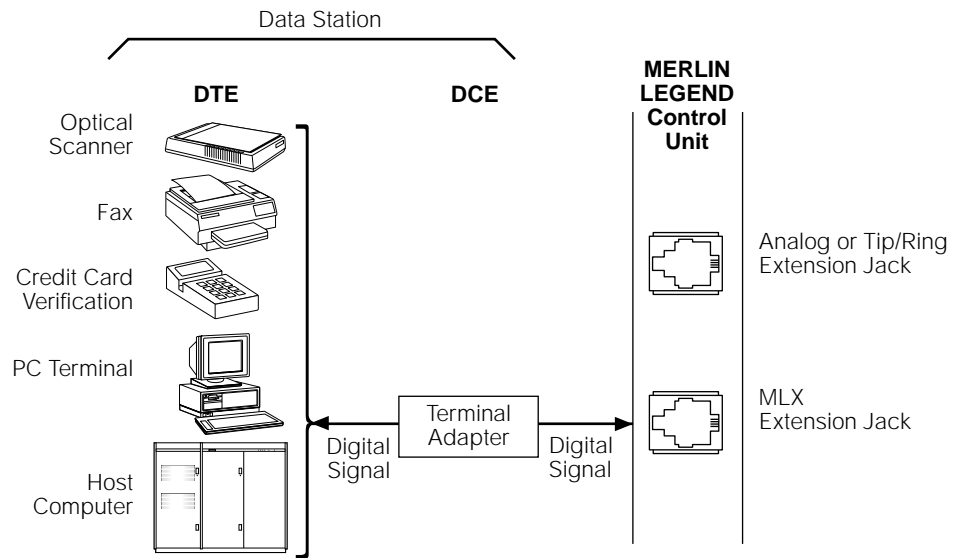

Figure 5-5. ISDN Terminal Adapter Data-Only

Summary of Data Station Configurations

Table 5–1 describes the extension jacks and equipment required for each data station configuration.

Table 5–1. Data Station Configurations

Type of Data Station	Module and Jack Type	Telephone (for voice)	GPA or MFM	Modem or ISDN Terminal Adapter	Data Terminal
Analog voice and Modem data	2 adjacent extension jacks on one of the following analog modules: 408, 408 GS/LS, or 008	Analog multiline telephone (and a BR-241-B1 bridging adapter)	GPA	Modem	PC
Modem data-only	1 extension jack on an 008 OPT, 016 or 012 module	None*	None	Modem	PC, LAN workstation, or local host
MLX voice and Modem data	1 extension jack on an 008 MLX or 408 GS/LS-MLX module	MLX telephone*	MFM	Modem	PC
MLX voice and ISDN terminal adapter data	1 extension jack on an 008 MLX or 408 GS/LS-MLX module	MLX telephone	None	ISDN terminal adapter	PC, LAN workstation, local host, or video conferencing
ISDN terminal adapter data-only	1 extension jack on an 008 MLX or 408 GS/LS-MLX module	None	None	ISDN terminal adapter (if using a 7500B data module, a 440A4 terminating resistor adapter is also required)	PC, LAN workstation, local host, or video conferencing
Digital Data/Video	1 extension jack on an 008 MLX or 408 GS/LS-MLX module set as a 2B Data port, or 2 jacks set as 1B Data ports†	MLX telephone may be connected in a passive bus arrangement when connected to some desktop video systems	None	None if station is connected by a BRI interface. One ISDN terminal adapter if the TA supports 2B Data. Two ISDN terminal adapters if the TAs support only 1B Data.	G4 FAX, video conferencing

* An analog telephone may be connected.

† A digital data/video station that connects directly to an MLX port using either a BRI interface or a v.35 interface and an ISDN terminal adapter that supports 2B Data, requires only one MLX port administered as a 2B Data port. A digital data/video station that connects to an MLX port using a v.35 interface and an ISDN terminal adapter that does not support 2B Data, requires two 1B Data MLX ports. When using the 008 MLX or 408 GS/LS-MLX module for digital data or video, you must use Version 28 of the module.

Other Supported Data Terminals

Other data equipment that may be connected to the system include analog data terminals using modem connections, such as the following:

- A local host computer
- Group III (G3) fax machine
- An output-only device
- An input-only device

A PC containing an internal modem card can also be connected to a T/R interface.

Other digital data terminals may be connected using ISDN terminal adapters, including the following:

- Group video conferencing system
- Group IV (G4) fax machine

For more information, including detailed hardware configuration illustrations, refer to the *Equipment and Operations Reference*.

Other Resource Groups

You can create the following types of special groups:

- **Modem-Only Group.** Provides access to multipoint data equipment, for example, a caller at a data station calling an online database system at an outside number, over analog lines/trunks.
- **ISDN Terminal Adapter-Only Group.** Provides access to multipoint equipment, for example, a host computer, by assigning the MLX ports interfacing with the ISDN terminal adapters in the pool to a DHG.

Data Hunt Groups

A data hunt group (DHG) is the same as a voice-extension calling group, except that the group in this case is a group of modems or a group of ISDN terminal adapters (not both). The group can be used to communicate with a local host computer or workstation (gateway) on a LAN.

All modems or ISDN terminal adapters in a DHG are assigned to a single extension number that is used both by inside and outside callers to reach the group. Users are given the DHG number that corresponds to the pool they need to reach.

Calls to the group are distributed among group members in a circular pattern. The system hunts for the first available modem or ISDN terminal adapter, starting with the one that received the last call. If all group members are unavailable, the caller hears a busy tone.

Guidelines for creating DHGs are contained in "Creating Data Hunt Groups," later in this chapter.

Data Hunt Group Configurations

The following DHG configurations work on the system:

- **ISDN Terminal Adapters.** Allows communications with the local host computer or a workstation (gateway) to a LAN.
- **Modems.** Allows communications with the local host computer or a workstation (gateway) to a LAN.

Video Systems

A video system is a hardware configuration that provides full-motion video teleconferencing. The video systems use both B-channels (2B Data) associated with an MLX port to achieve data rates of up to 128-kbps when using PRI or NI-1 BRI facilities, and 112-kbps when using T1 Switched 56 facilities.

There are two basic types of video teleconferencing:

- **Personal Video Conferencing.** This type, also referred to as Desktop Video Conferencing, typically is a single user communicating with another individual using their PC.
- **Group Video Conferencing.** This type, as the name implies, allows larger groups of people to communicate with another group at a different location.

Personal Videoconferencing

A personal videoconferencing system typically consists of a video camera and an audio unit connected to a PC. The PC connects directly to any available MLX port on a 408 MLX or 008 MLX module by way of a BRI interface card.

NOTE:

When using the 008 MLX or 408 GS/LS-MLX module for data or video, you must use Version 28 of the module.

The MLX port must be configured as a 2B Data port in order to provide the necessary high-speed data connection needed to support full-motion video applications. The network facilities used by the endpoint connected to the MLX port may be PRI, T1 Switched 56 (both provided by the 100D module), or NI-1 BRI (provided by the 800 NI-BRI module) facilities.

NOTE:

Some applications also provide data and application sharing and transfer capabilities (video collaboration) in addition to full-motion video conferencing.

This configuration, in which the personal video system is the only device connected to the MLX port, is called the *Standalone* configuration. Some personal video systems also offer the capability to support a *Passive Bus* configuration. See Figure 5-6 for a sample connection diagram.

Passive Bus Configuration

In the passive bus configuration, one MLX port serves both the personal video system and an MLX telephone. The MLX telephone is connected to a second jack on the personal video system interface card, or to a special connector, rather than being connected directly to the MLX module.

This configuration allows the user to make and receive voice calls on the MLX telephone and video calls with the personal video system.

NOTE:

When connected in the passive bus configuration, the possibility of contention between the MLX telephone and the personal video system for the available MLX B-channels exists. If the personal video system is active on a 2B Data call, the MLX telephone cannot be used to make or receive voice calls. Conversely, if the MLX telephone is active on a voice call, the personal video system cannot make or receive a 2B Data call, only a 1B Data call (using only one B-channel) can be established.

Group Videoconferencing

A group videoconferencing system consists of a video camera, an audio unit, and a display screen (such as a television) that connect to a CODEC. The CODEC converts the analog voice and video signals into digital form for transmission, and converts the digital signals received back into analog form.

The CODEC may use either a BRI interface to connect directly to an available MLX port on a 408 MLX or 008 MLX module, or a v.35 interface to connect to an ISDN terminal adapter (such as the ExpressRoute 1000 or 7500B data module) which in turn connects to an MLX port.

NOTE:

When using the 008 MLX or 408 GS/LS-MLX module for data or video, you must use Version 28 of the module.

When the group videoconferencing system uses a BRI interface, or an ISDN terminal adapter that supports 2B Data, the video system may be connected to a single MLX port that has been configured as a 2B Data port. This allows the video system to use both B-Channels assigned to the MLX port, thereby achieving the high-speed data connection necessary to support full-motion video.

If the group videoconferencing system uses a v.35 interface to connect to an ISDN terminal adapter that does *not* support 2B Data, then two ISDN terminal adapters are required (each connecting to a separate MLX port that has been configured as a 1B Data port) in order to achieve a 2B Data connection.

NOTE:

Do not connect equipment, such as an ISDN terminal adapter or G4 FAX machine, that does not support 2B Data to an MLX port that has been configured as a 2B Data port. This wastes system resources and may cause other system errors.

The network facilities used by the endpoint connected to the MLX port may be any combination of PRI, T1 Switched 56 (both provided by the 100D module), and/or NI-1 BRI (provided by the 800 NI-BRI module) facilities, however it is recommended that you use two B-channels of the same type to ensure the best possible connection. See Figure 5-6 for a sample connection diagram.

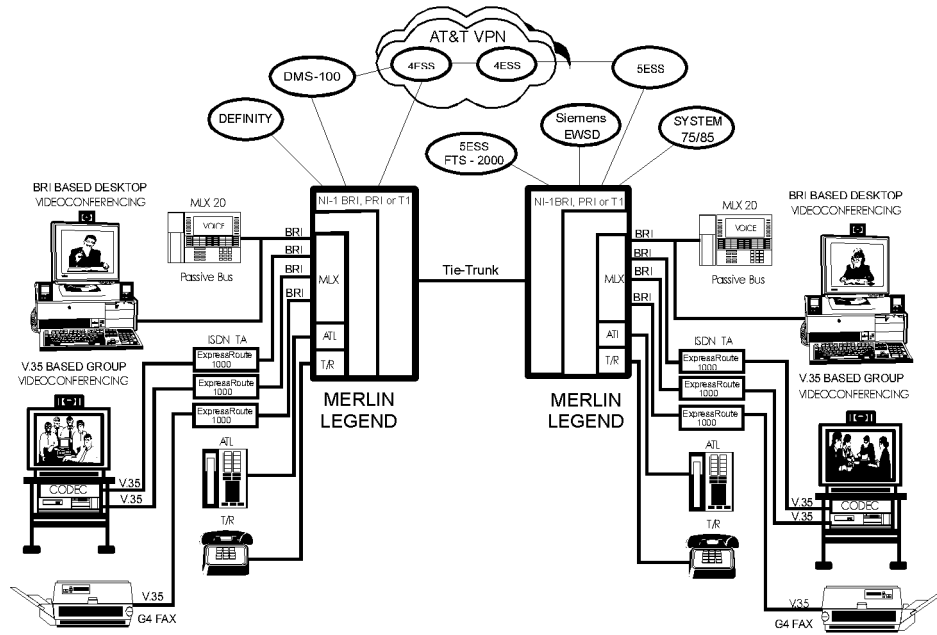

Figure 5-6. Personal and Group Video Connections

Planning Overview

By using the procedures earlier in this book, you should have already reserved the following:

- Trunk jacks for outside lines/trunks
- Extension jacks for voice telephone users
- Extension jacks for either:
 - Analog multiline telephones with a modem data station connected to a General-Purpose Adapter (GPA)
 - MLX telephones with either a modem data station connected using an MFM or a digital data station connected using an ISDN terminal adapter
 - Digital data/video equipment (such as G4 FAX, and personal or group video systems) connected either directly to an MLX port or connected to an MLX port by way of an ISDN terminal adapter

Forms Needed

Whether you are planning data options for a new system or modifying an existing system, you record data communications planning information by making additional entries on forms already completed earlier in this book, and on the appropriate data forms shown in Table 5–2. Duplicate the master data forms in Appendix C, “Data Forms,” and work on the copies. Use the forms listed in Table 5–3, as needed. See application note, *MERLIN LEGEND Communications System Modem Pooling*, for details.

NOTE:

Behind Switch mode is not included in these instructions. It works the same way as Key mode.

Table 5–2. Data Forms

To Plan New or to Modify Existing Systems	Use These Forms
Trunk assignments	1a, Modem Data Station 1b, ISDN Terminal Adapter Data Station
Feature assignments	1a, Modem Data Station 1b, ISDN Terminal Adapter Data Station
Data hunt groups	2, Data Hunt Groups
Digital data and/or video stations	3, Digital Data/Video Station

Table 5-3. System Forms

To Plan	Form Needed
Extension jack connections* modem data stations ISDN terminal adapter data stations local host computer connections LAN workstation access connections modem/ISDN terminal adapter pools* video systems (personal or group)	2a, System Numbering: Extension Jacks (for all configurations)
Line/Trunk assignments	2a, System Numbering: Extension Jacks 2b, System Numbering: Digital Adjuncts 2c, System Numbering: Line/Trunk Jacks
Feature assignment	2a, System Numbering: Extension Jacks 2b, System Numbering: Digital Adjuncts 4d, MLX Telephones 4b, Analog Multiline Telephone 4e, MFM Adjunct: MLX Telephone 5b, Direct-Line Console (DLC): Digital 5c, MFM Adjunct: DLC
Dial-out code (Hybrid/PBX only)	2c, System Numbering: Line/Trunk Jacks
ARS Facility Restriction Level (Hybrid/PBX only)	3f, Automatic Route Selection Tables 3g, Automatic Route Selection Default and Special Numbers Table
Data hunt groups	2c, System Numbering: Line/Trunk Jacks 2d, System Numbering: Special Renumbers 7d, Group Calling

* You must make an entry for extension jack connections.

Assigning Extension Jacks

Following some guidelines about digital extension jacks, this section contains procedures to plan extension jack connections for the following:

- Modem data-only stations
- ISDN terminal adapter data-only stations
- Local host computer data stations
- LAN workstations
- Video systems (personal or group)

For each type of data station, planning how the data equipment connects to extension jacks on the control unit involves the following tasks:

1. Review Form 2a, on which you entered codes (A for analog, D for digital, and B for basic telephone) and find the telephone type and the user, location, or function for each data station to be connected. Table 5–4 lists extension jack types, corresponding module types, and the equipment that can be connected.
2. Add the extension jack assignments to Form 2a.

Table 5–4. Extension Jack Types

Jack Type	Module Type	Connects
Analog	008 408 408 GS/LS	Analog multiline telephones (including analog voice-and-data stations with a modem connected through a GPA)
Digital	008 MLX 408 GS/LS-MLX	MLX telephones (including MLX voice-modem data stations) MLX telephones (including MLX voice and ISDN terminal adapter stations) ISDN terminal adapter data terminals (such as PCs) Video systems (personal or group)
Basic	012 016 008 OPT	T/R equipment: Single-line telephones Adjuncts, such as fax or answering machines Modem data-only stations Tip/ring equipment in another building or off-site

Before you assign extension jacks for ISDN terminal adapter data stations, review the guidelines in the next section, "Guidelines for Digital Extension Jacks."

Guidelines for Digital Extension Jacks

Although only one logical ID is assigned to each digital extension jack, the system automatically assigns *two* extension numbers:

- The first extension number shown on Form 2a is assigned to an MLX telephone connected to the extension jack
- The second extension number assigned to each jack is reserved for an adjunct, such as a ISDN terminal adapter data terminal or desktop video endpoint, connected to the MLX telephone.
- If a personal or group video system is connected to the MLX port, extension numbers are assigned to the video system for use in 2B Data connections.

Both extension numbers are assigned automatically, whether or not the extension includes an ISDN terminal adapter. Calls can be placed to both extension numbers independently. Note that an MLX extension cannot have both an ISDN terminal adapter and an MFM.

Also, when configuring digital data equipment connections to an MLX port, the following requirements and/or restrictions must be applied:

- If using a 7500B data module as an ISDN terminal adapter, and it is the only ISDN terminal adapter data station on the MLX port (no MLX telephone is connected), a 440A4 terminating resistor adapter must be configured to provide 100-ohm termination for each transmission pair. The 7500B data module does not provide termination.
- An MLX telephone is independent from the ISDN terminal adapter; however, the telephone may cause channel conflict between the telephone and the ISDN terminal adapter when the telephone is voice-signaled while active on a call. If a slight chance of data call blocking is unacceptable, an MLX telephone should not be connected to an ISDN terminal adapter used in a data station configuration.
- The maximum cord length from an MLX telephone to an ISDN terminal adapter is 80 feet (24 meters). This should be considered if you plan to use the voice capability of a port by connecting an MLX telephone far from the ISDN terminal adapter.
- Do not connect an ISDN terminal adapter that does not support 2B Data to an MLX port that has been administered as a 2B Data port.
- When using the 008 MLX or 408 GS/LS-MLX module for data or video, you must use Version 28 of the module.

Modem Data-Only Stations

A modem data-only station consists of a data terminal connected to the control unit using an internal or external modem. This station does not include a telephone.

Assign a basic telephone extension jack on an 012, 016, or 008 OPT module; either an on- or off-premises extension can be connected to an 008 OPT module.

Planning Form Instructions

Record the extension jack assignments for modem data stations on Form 2a, System Numbering: Extension Jacks:

1. In the Jack Type column, make sure there is a B next to the number for each basic extension jack.
2. In the Person, Location, or Function column, write **modem** and then identify each modem data station by person, location, or function.

ISDN Terminal Adapter Data-Only Stations

An ISDN terminal adapter data-only station consists of a PC or a data terminal connected to an ISDN terminal adapter. Each ISDN terminal adapter data station connects to a digital extension jack on an 008 MLX or 408 GS/LS-MLX module.

Planning Form Instructions

Record the extension jack assignments for ISDN terminal adapter data stations on Form 2a, System Numbering: Extension Jacks:

1. In the Jack Type column, make sure there is a D next to the number for each digital extension jack.
2. In the Person, Location or Function column, write **ISDN-TA** and identify each ISDN terminal adapter data station by person, location, or function.
3. Fill in Form 2b with the extension number of the ISDN terminal adapter.

Local Host Computer Data Stations

A local host computer data station consists of a local host computer, a data terminal for that computer, and one or more ISDN terminal adapters and/or modems.

Assign each ISDN terminal adapter used for access to a host computer to a digital extension jack on an 008 MLX or 408 GS/LS-MLX module. Assign each modem to a basic telephone extension jack on an 012, 016, or 008 OPT module.

If you have a limited number of ISDN terminal adapters or modems to share among many users, assign some or all of the modems or ISDN terminal adapters to a DHG. In this way, users can access all the devices in the DHG by dialing one extension number.

Users access the computer by placing a data call to the extension number for either an ISDN terminal adapter or modem (or DHG)—depending on the user's type of data station—that is assigned for communication with the local host computer.

Planning Form Instructions

Record the extension jack assignments for local host computer access extensions on Form 2a, System Numbering: Extension Jacks:

NOTE:

Before you assign extension jacks for a local host computer, review the guidelines in "Guidelines for Digital Extension Jacks," earlier in this section.

1. For each digital extension jack used to connect an ISDN terminal adapter:
 - a. In the Jack Type column, make sure there is a D next to the number for each digital extension
 - b. In the Person Location, or Function column, write **Terminal Adapter-host**.
2. For each basic telephone extension jack you plan to use to connect a modem:
 - a. In the Jack Type column, make sure there is a B next to the number
 - b. In the Person, Location or Function column, write **modem-host**.

LAN Workstations

A Local Area Network (LAN) consists of workstations (PCs) connected together to share resources. The system connects to the LAN through a workstation that functions as a gateway, providing ports for modem and ISDN terminal adapter connections.

Assign each ISDN terminal adapter used for access to a LAN workstation to a digital jack on an 008 MLX or 408 GS/LS-MLX module. Each modem must be connected to a basic telephone extension jack on an 012, 016, or 008 OPT module.

If you have a limited number of ISDN terminal adapters or modems to share among many users, assign some or all of the modems or ISDN terminal adapters to a DHG. In this way, users can access all the devices in the DHG by dialing one extension number.

Users access the computer by placing a data call to the extension number for either an ISDN terminal adapter or modem (or DHG)—depending on the user's type of data station—that is assigned for communication with the local host computer.

Planning Form Instructions

Record the extension jack assignments for access to a workstation on a LAN on Form 2a, System Numbering: Extension Jacks:

1. For each digital extension jack used to connect an ISDN terminal adapter:
 - a. In the Jack Type column, make sure there is a D next to the number for each digital extension.
 - b. In the Person Location, or Function column, write **Terminal Adapter-LAN**.
2. For each basic telephone extension jack you plan to use to connect a modem:
 - a. In the Jack Type column, make sure there is a B next to the number for each basic telephone extension jack used to connect a modem.
 - b. In the Person, Location or Function column, write **modem-LAN**.

Video Systems

Video systems may connect to an MLX port on the MERLIN LEGEND system either directly through a BRI interface, or by way of a v.35 interface and an ISDN terminal adapter.

Assign each video system that is connected directly to the MLX port, or connected to an ISDN terminal adapter that supports 2B Data, to one digital jack configured as a 2B Data port on an 008 MLX or 408 GS/LS-MLX module.

Assign each video system that is connected to an MLX port by way of an ISDN terminal adapter that does *not* support 2B Data to two separate digital jacks configured as 1B Data ports on an 008 MLX or 408 GS/LS-MLX module.

Planning Form Instructions

Record the extension jack assignments for video systems on Form 2a, System Numbering: Extension Jacks:

1. In the Jack Type column, make sure there is a D next to the number for each digital extension.
2. In the Person, Location, or Function column, enter the type of equipment connected. Also make a note to indicate whether a passive bus MLX telephone is connected if applicable.

Assigning Lines/Trunks to Data and Video Stations

The following types of outside lines/trunks are used to make and receive data calls to and from data stations outside of the system:

- **Loop-Start (LS).** This is the standard line/trunk for homes and small businesses, and can be used to communicate with outside modem data stations. Video calls are not made over loop-start lines/trunks. Loop-start lines/trunks are the least expensive lines/trunks in some areas but have the following disadvantages:
 - They do not protect against glare, a condition that occurs when an outside call is made at the same time that an incoming call arrives on the same line/trunk.
 - They *may not* provide reliable far-end disconnect for toll restriction.



SECURITY ALERT:

Toll fraud can occur when loop-start lines/trunks are used with unreliable disconnect. If the calling party stays on the line after the called party hangs up, the central office will return a dial tone at the conclusion of the call enabling the caller to place another call as if it were being placed from your company.

- **Ground-Start (GS).** This line/trunk is preferred for communication with outside modem data stations. Ground-start lines/trunks provide improved signaling and reliable far-end disconnect for secure toll restriction. Video calls are not made over ground-start lines/trunks.

The following kinds of outside ground-start or loop-start lines/trunks can be used for data communications:

- Basic lines/trunks
- Wide area telecommunications service (WATS)
- 800 service (inbound WATS)
- Foreign exchange (FX)

Ground-start/loop-start lines/trunks connect to ground-start/loop-start jacks on the following types of modules in the control unit:

- 800 GS/LS
- 400 GS/LS/TTR
- 408 (LS lines/trunks only)
- 408 GS/LS

- 400 (LS lines/trunks only)
- 800 (LS lines/trunks only)
- 408 GS/LS-MLX
- 800 GS/LS-ID

- **Analog/Digital Tie.** This trunk type “ties” two telephone switching systems together, providing access to all telephones or data equipment on each system. Analog Tie trunks are used for data communication with modem data stations connected to a system at a different location, such as a different floor of a building, a different building, or a different city or state. Analog Tie trunks connect to a jack on a 400EM module in the control unit. Video calls are not made over analog Tie lines/trunks.

Digital Tie trunks are used for digital data communications, such as G4 FAX and videoconferencing, with digital data/video stations connected to a system at a different location, such as a different floor of a building, a different building, or a different city or state. Digital Tie trunks are emulated by T1 facilities connected to a 100D module in the control unit. Video and digital data calls may be made over digital Tie lines/trunks.

- **Direct Inward Dial (DID).** Incoming calls reach specific individuals or facilities in the system without the help of a system operator. DID trunks are available only in Hybrid/PBX mode. A DID trunk is used to receive incoming calls from outside modem data stations. It is not used for outgoing calls. A DID trunk connects to a jack on an 800 DID module in the control unit. Video calls are not made over DID lines/trunks.
- **DS1 (Digital Signal 1).** This facility carries digital signals in the DS1 format. A DS1 facility can be used for communication with outside digital or modem data stations, including video systems. A DS1 facility connects to the jack on a 100D module in the control unit. Even though there is only one physical jack, the 100D module supports up to 24 logical endpoints for voice and data calls; each DS0 channel in the DS1 signal corresponds to a trunk or logical ID.

A DS1 facility provides either T1 (including T1 Switched 56 for digital data/video calls) or PRI access:

- **T1 (factory setting).** The 24 channels on a T1 facility can be programmed individually in any combination to emulate a loop-start, ground-start, E&M tie, DID, or Switched 56 digital data trunk, so a single 100D module can replace 24 outside lines/trunks. When T1 Switched 56 service is used, high-speed video connections at data rates of 56-kbps per channel (112-kbps for 2B Data) are possible.

- **PRI.** The standard format for ISDN services provided by connection to a 5ESS central office (CO) switch or a 4ESS or DEFINITY toll switch. PRI facilities provide several benefits, including increased speed of data calls to an outside destination, INFO-2 automatic call identification (ANI) service, dynamic B-channel assignment, improved toll restriction, reliable indication of far-end disconnect, and improved SMDR. Twenty-three channels can be programmed for individual services (Channel 24 is reserved for signaling purposes). PRI facilities may also be used for high-speed video calls at data rates of up to 64-kbps per B-channel (128-kbps total for 2B Data).

The 100D module supports any combination of the following AT&T Switched Network services:

- ACCUNET Switched Digital Service for 56-kbps and 64-kbps restricted and 64-kbps clear (unrestricted) circuit-switched data calls (PRI only)
 - ACCUNET Switched 56 Service for 56-kbps (restricted or unrestricted) data calls (T1 only)
 - Megacom 800 for incoming domestic toll-free voice calls
 - Megacom WATS service for outgoing domestic long-distance voice calls
 - Software-Defined Network (SDN) for circuit-switched voice and data calls at up to 56 kbps
- **NI-1 BRI.** Basic Rate Interface (BRI) is a protocol within the ISDN standard that provides digital voice, data, and video connectivity. NI-1 BRI facilities connect to a jack on the 800 NI-BRI module, with each facility providing two B-channels per jack (total of 16 NI-1 BRI channels per 800 NI-BRI module). BRI facilities provide high-speed data rates of up to 64-kbps clear (unrestricted) circuit-switched data calls per B-channel (128-kbps total for 2B Data).

To assign lines/trunks to data stations, you decide on the types of line buttons that are assigned to the data communications equipment at each data station. The data stations are:

- Analog voice and modem data stations and MLX voice and modem data stations
- MLX voice and ISDN terminal adapter data stations including telephones
- Modem data-only stations
- ISDN terminal adapter data-only stations
- Digital data/video stations

The system treats each data station, except for the analog voice and modem data stations, as an extension with a 34-button telephone.

When you choose the mode of operation (Key, Behind Switch, or Hybrid/PBX), Intercom (**ICOM**) or System Access (**SA**) buttons are assigned automatically to every extension connected to the control unit. However, you can customize the system by changing the factory-set assignments and reassigning line buttons. The number and types of buttons assigned depends on the mode chosen and the type of extension jack you are using.

For detailed information and telephone programming requirements for lines/trunks, see the *Equipment and Operations Reference*.

NOTE:

Trunks cannot be independently assigned to analog voice and modem data stations. The line/trunk assignment for the telephone also includes the modem extension; therefore, these instructions are not used for these types of data stations.

Forms Needed

- Data Form 1a, Modem Data Stations
- Data Form 1b, Data Stations
- Form 4e, MFM Adjunct: MLX Telephone
- Form 5c, MFM Adjunct: DLC

Planning Form Instructions

You should have already filled out preliminary information on Forms 4e and 5c when you planned voice communications. The lines/trunks for MLX telephones have already been assigned.

There are two different forms for data stations:

- **Data Form 1a.** Use this form for modem data-only stations and for modems used to communicate with the local host computer and to communicate with a workstation on a LAN.
- **Data Form 1b.** Use this form for ISDN terminal adapters and ISDN terminal adapter data stations used to communicate with the local host computer and to communicate with a workstation on a LAN.

Make enough copies of each data form so that you can complete one form for each data station. Complete each form:

1. From Form 2a, System Numbering: Extension Jacks, obtain the identification information for each data station.
2. Record the information on the appropriate data form (2a or 2b) for each data station and for each modem and ISDN terminal adapter used to communicate with a local host computer or with a workstation on a LAN:
 - a. In the Logical ID space, write the logical ID for each extension.
 - b. In the Extension No. space, write the extension number for each extension.
 - c. In the Person or Location space, write the name of the person or the location of the data equipment.
 - d. Under the Data Station Use heading, indicate the purpose of the data station by checking *one* of the following boxes: Individual use, Local host computer, or LAN workstation.

Assigning Line Buttons in Hybrid/PBX Mode

The line buttons you can assign to data stations are as follows:

- **System Access Ring.** Used to make and receive inside and outside data calls. To make outside calls, the user selects an outside line/trunk by dialing either the code for Automatic Route Selection (ARS) or the dial-out code for the trunk pool. Users at ISDN terminal adapter data stations and video endpoints can also dial the line/trunk number (801–880) to select an outside line/trunk.
- **Personal Line.** Used to make and receive outside data calls from a data station on a specific outside line/trunk. A personal line is an outside line/trunk assigned to a line button on one or more data or voice stations. The outside line/trunk cannot be a member of a pool.

To dedicate an outside line/trunk for data calls and have the calls automatically answered by data equipment, do not assign the same outside line/trunk to both data equipment and telephones because modems answer voice calls as data calls.

On analog voice-and modem data stations, a personal line can be used to receive incoming calls. A personal line can be used for outgoing calls by selecting the line button on the analog multiline telephone, dialing, and then activating the modem connected through a GPA.

On ISDN terminal adapter data stations, a personal line can be used to make and receive outside data calls. To select the line/trunk for an outgoing call, the caller dials the line/trunk number (801–880). To allow the user at an ISDN terminal adapter data station access to the digital network for making and receiving calls to outside digital data stations, assign PRI, NI-1 BRI, or T1 Switched 56 (including T1-Tie lines using Switched 56 service) facilities as personal lines.

- **Pool.** Used when you want the voice and data station to make and receive outside data calls on a specific trunk pool (for example, a pool with PRI facilities) without dialing a dial-out code. The **Pool** button is used to make and receive only outside calls. Automatic Line Selection should be set to the **Pool** button in order to place calls on it.

NOTES:

1. Do not assign System Access Voice (**SA Voice**) buttons to data communications equipment.
2. You must use PRI facilities with a digital data service such as ACCUNET Switched Digital Service, a Software Defined Network (SDN), T1 Switched 56 facilities, or NI-1 BRI facilities for digital data calls.
3. T1 facilities that are not using Switched 56 service can be used for modem data and analog voice calls and can be assigned to telephones to allow the voice user to make and receive voice calls using these types of facilities.

The following line button assignments are factory set for Hybrid/PBX mode and are prerecorded on the Button Diagram on Data Forms 1a and 1b:

- One System Access Originate Only (**SA Orig Only**) button and two System Access Ring (**SA Ring**) buttons are assigned to all data equipment connected to an 012, 016, or 008 OPT module.
- One System Access Originate Only (**SA Orig Only**) button, one System Access Ring (**SA Ring**) button, and a System Access Voice (**SA Voice**) button are assigned to all data equipment connected to a digital extension jack on an 008 MLX or 408 GS/LS-MLX module. Remove the **SA Voice** button (see Form 5c, page 1).

The factory settings can be changed; however, the settings should be adequate to meet most user needs, since System Access lines can be used to make both inside and outside data calls. Each data extension must have at least one **SA** button, or two **SA** buttons for making 2B Data calls. If making 2B Data calls with two DFT/DPT buttons, you must also have two **SA** buttons.

If you want an ISDN terminal adapter data station to make and receive outside data calls on a specific outside line/trunk, assign a personal line button. To make calls on a personal line, set the Automatic Line Selection to that line.

Assigning Pools and Lines/Trunks (Hybrid/PBX Mode)

If you want the voice and data station to make and receive outside calls on a specific trunk pool, assign a **Pool** button.

To dedicate a specific line/trunk or pool to receive outside data calls, assign a personal line or pool to a data station or DHG.

To dedicate specific lines/trunks for use in data communications only (such as PRI channels or other special data lines), consider grouping those lines/trunks in a pool.

If the system uses ARS, follow the instructions on ARS earlier in this book to specify routes for outgoing data calls.

To restrict non-data users from dial access to data trunk pools, use the "Pool Dial-Out Code (Hybrid/PBX Only)" instructions later in this chapter.

Forms Needed

- Form 2c, System Numbering: Line/Trunk Jacks
- Data Form 1a, Modem Data Station
- Data Form 1b, ISDN Terminal Adapter Data Station

Planning Form Instructions

Record your decisions for each data station on the Hybrid/PBX Mode Button Diagram of Data Form 1a or 1b.

1. If you want to assign personal lines to the data station, write **Personal Line** and the telephone number (from Form 2c) of the outside line on the appropriate button. For ISDN terminal adapter data stations, include the line/trunk number.
2. If you want to assign a pool to the data station, write **Pool** and the pool's extension number (from Form 2c) on the appropriate button.

NOTE:

On modem data stations from which the user does not need to make inside calls, you can assign only personal lines or pools; when going off-hook, the user or equipment gets a telephone company line/trunk by Automatic Line Selection.

Assigning Line Buttons in Key Mode

There are two kinds of line buttons you can assign to data stations used to make and receive data calls:

- **Intercom Ring.** Used to make and receive inside data calls only.
- **Outside Line/Trunk.** Used to make and receive outside data calls on a specific outside line/trunk. An outside line/trunk can be assigned to a line button on one or more data stations or voice extensions. To dedicate an outside line/trunk for data calls and have the calls automatically answered at a data station, do not assign the same outside line/trunk to data stations and to telephones, because modems answer voice calls as data calls.

For digital data stations, the outside line/trunk can be used to make and receive outside data calls. For an outgoing call, the user dials the line number (801–880) to select the line/trunk.

To allow the user at an ISDN terminal adapter data station access to the digital network for making and receiving calls to outside digital data stations, assign PRI facilities with digital data service such as ACCUNET Switched Digital Service and Software Defined Network (SDN), NI-1 BRI, or T1 Switched 56 facilities to ISDN terminal adapter data stations. If these facilities are not available, the ISDN terminal adapter data station user can make calls over the regular analog telephone network only by using a digital-to-analog modem pool, described in application note, *MERLIN LEGEND Communications System Modem Pooling*.

NOTE:

PRI and NI-1 BRI facilities are also used for analog data and voice calls and can be assigned to telephones to allow the voice user to make and receive voice calls using these types of facilities.

The following line button assignments are factory set for Key mode and are prerecorded on the Button Diagram on Data Forms 1a and 1b. Two Intercom Ring (**ICOM Ring**) buttons are assigned to the following:

- Data equipment connected to an 012 or 008 OPT module.
- All equipment connected to a digital extension jack on an 008 MLX or 408 GS/LS-MLX module.

The factory settings can be changed; however, at least one **ICOM** button must be assigned to each data station. To allow a user to make and receive outside data calls, you must assign an outside trunk to the data station.

To dedicate a specific line to receive outside data calls, assign an outside line/trunk to a data station, DHG, LAN workstation, or local host computer.

On a digital or analog data station, the user selects an outside line/trunk by dialing the Idle Line Preference code (usually **7**) on an **ICOM** button. On an ISDN terminal adapter data station, the user can also select lines/trunks assigned to the extension by dialing the line number (801–880) assigned to that outside line/trunk.

It is extremely important that the factory-set Idle Line Preference (the line to which the user is connected automatically when going off-hook) not be changed. The user must be connected to an intercom line to activate features such as Privacy or to select an available outside line/trunk by dialing the Idle Line Preference code.

Planning Form Instructions

Using Form 2c, System Numbering: Line/Trunk Jacks as reference, record your decisions for each data station on the Key mode Button Diagram of Data Form 1a or 1b. If you want to assign outside lines/trunks to the data station, write the telephone number (from Form 2c) of the outside line/trunk on the appropriate button. For ISDN terminal adapter data stations, include the line/trunk number.

Assigning Features to Data Stations

Many of the features used for voice calls (as described earlier in this guide) can also be assigned to data stations. This section describes these features and how to assign them to each ISDN terminal adapter or modem data station. This includes modem data stations with an MLX telephone using an MFM, ISDN terminal adapter data stations with a telephone, and modem and ISDN terminal adapter data-only stations (data stations with no telephone).

NOTE:

Features cannot be independently assigned to modem data stations connected to analog multiline telephones using a General-Purpose Adapter (GPA). The feature assignment for the telephone also includes the modem; therefore, the following planning instructions are not used for these types of data stations.

The following optional features can be assigned to data stations:

- **Account Code Entry.** This feature allows tracking of outgoing data calls for billing, forecasting, or budget reports.
- **Auto Answer All.** This feature allows a modem with automatic answering capability to answer data calls when the user is away from the data station. Supports analog voice and modem data stations only.
- **Automatic Route Selection (Hybrid/PBX Mode Only).** This feature routes calls over outside lines/trunks according to the number dialed and the lines/trunks available. Therefore, the system can be programmed to select the least expensive route for each data call over either PRI, NI-1 BRI, or T1 Switched 56 facilities.

- **Calling Restrictions.** These features inhibit line access, and allow companies to control and manage communications costs for outgoing data calls.
- **Data Status.** This button allows monitoring of station activity (busy, not busy) at any data station. Although this feature is similar to having an Inside Auto Dial or Signaling button because it lights the green LED to indicate extension-busy status, pressing the button has no effect. It does not dial the data extension number. Thus, the button does not interfere with a data call in progress, unlike an Auto Dial button, which dials its programmed number.
- **Personal Lines.** This feature provides direct access from an ISDN terminal adapter data station to outside lines supporting the PRI, NI-1 BRI, or T1 Switched 56 interface.
- **Idle Line Preference.** This feature automatically selects the first available line for data calls.
- **Last Number Dialed.** This feature automatically places a call to the last number dialed from that data station. Dialing sequence must include dial-out code for outside calls.
- **Personal Speed Dial.** These 2-digit numbers are programmed for quick dialing of frequently used numbers. The dialing sequence requires a dial-out code for outside calls.
- **Privacy.** This feature prevents loss of data by ensuring that data transmission is not interrupted accidentally. Privacy is automatic for data calls on ISDN terminal adapter data stations and on analog voice and modem data stations. Privacy is activated manually on modem data-only stations.
- **System Speed Dial.** This feature allows quick dialing of numbers that are used often systemwide. The dialing sequence requires a dial-out code for outside calls. The System Speed Dial feature is programmed systemwide for both voice and data stations. Follow the instructions earlier in this book to assign System Speed Dial codes to data station users.

IMPORTANT:

Certain system (voice) features interfere with data connections. System features that must be disabled are the following:

- Voice Announce
- Call Waiting
- Automatic Callback

For detailed information about these features, refer to the *Feature Reference*. For information on planning for features not described in this section, use the guidelines presented in the appropriate sections earlier in this book.

Forms Needed

- Data Form 1a, Modem Data Station
- Data Form 1b, ISDN Terminal Adapter Data Station
- Form 4e, MFM Adjunct: MLX Telephones
- Form 5c, MFM Adjunct: DLC

Pool Dial-Out Code (Hybrid/PBX Only)

Use these instructions only if the system is operating in Hybrid/PBX mode.

The factory setting is for *all* extensions, including data stations, to be restricted from using *all* dial-out access codes. You can unrestrict data stations to allow the user access to one or more trunk pools by dialing the pool dial-out code.

The dial-out code restriction places data calls only on specific trunk pools. For example, you may want to restrict users to trunk pools that are made up of special data lines such as PRI channels used for data services, or to reserve other trunk pools for voice communications only.

Planning Form Instructions

Use the Optional Features section of Data Form 1a or 1b for each data extension to record your decisions:

1. In the Optional Features section, under the Pool Dial-Out Code Restriction heading:
 - a. Check Unrestricted from following codes and list the codes in the space provided for unrestricted use.
 - b. Check Restricted from following codes and list the codes in the spaces provided for restricted use. The factory default is restricted for all codes.
2. Use Form 2c, System Numbering: Line/Trunk Jacks to locate the dial-out codes for each pool that the data station is restricted from using. Write the dial-out codes on the lines below the Yes box.

Calling Restrictions

When the system is first set up, all data stations are restricted. This means that only inside (intercom) calls may be made, local and long-distance calls may not be placed from any data station. However, you can unrestrict selected data stations to allow local and long-distance calls.

Planning Form Instructions

Use the Optional Features section of Data Form 1a or 1b for each data station to record your decisions. Under the Call Restriction heading, do *one* of the following:

- If you do *not* want calling restrictions for this data station, check the Unrestricted box.
- If you want the data station restricted from making any outside calls, check the Outward Restrict box (factory setting).
- If you want the data station restricted from making long-distance calls (intercom and local calls can be made), check the Toll Restrict box.

Forced Account Code Entry

The Forced Account Code Entry feature is used for billing or for tracking data calls by requiring data extension users to enter account codes (1 to 16 digits) for outside calls. Assign this feature to data stations so that you can associate outgoing data calls with specific client accounts.

NOTE:

Account codes cannot be used to track incoming calls to data stations.

Planning Form Instructions

To record your decisions, use the Optional Features section of Data Form 1a or 1b for each data station. Under the Forced Account Code Entry heading, do *one* of the following:

- If the user must enter an account code for outgoing calls, check the Yes box.
- If you do not want the feature assigned to the data station, check the No box (the factory setting).

ARS Facility Restriction Level

Use these instructions only if the system is operating in Hybrid/PBX mode.

If the system uses ARS for data calls, you can assign a Facility Restriction Level (FRL) to each data station. This value (from 0 to 6) corresponds to the FRL assigned to each route and is used to restrict data users from access to specific routes. Before restricting a data station, review the values assigned to each route.

To restrict a data station from specific routes, assign an FRL value lower than the route's lowest value. (Values equal to or greater than the route's values allow data extension users to access those routes.) A value of 0 is the most restrictive, and a value of 6 is the least restrictive. The factory setting is 3.

For example, to give an modem data station unlimited use of any ARS route, assign a value of 6. If you have ISDN terminal adapter data stations, assign a value of 0 to prevent users from inadvertently using ARS to select an analog line for outside data calls.

Planning Form Instructions

1. Using Form 3f, Automatic Route Selection Tables and Form 3g, Automatic Route Selection Default and Special Numbers Table, review the values assigned to the routes.
2. In the Optional Features section of Data Form 1a or 1b for each data station to record your decisions about Facility Restriction Level, do *one* of the following:
 - Check 3 to keep the factory setting.
 - Write the value (0 to 6) for the ARS Facility Restriction level you want to assign to each data station.

System Speed Dial Codes

To avoid giving the telephone number of a remote computer to modem pool users, assign a System Speed Dial code to the telephone number. Users can dial this 3-digit code to place data calls to the remote computer.

For data calls, the telephone number programmed for a System Speed Dial code must include the access code (the dial-out code or the ARS dial-out code) if required.

To specify that the remote computer's telephone number does not appear on call reports, use the System Speed Dial instructions in Chapter 4 of this book.

Creating Data Hunt Groups

Use these instructions if the system has a group of modems or ISDN terminal adapters.

DHGs are data calling groups that provide uniform call distribution among a group of modems or a group of ISDN terminal adapters (such as the ExpressRoute 1000 or 7500B data module). DHGs support the following:

- Modem pools
- Dedicated lines for data service
- A local host computer
- Workstation that functions as a gateway on a LAN

For more information, see the "Planning Overview," earlier in this chapter, or refer to *Equipment and Operations*. For information on modem pools, see application note, *MERLIN LEGEND Communications System Modem Pooling*.

Guidelines

Use the following guidelines for the procedure in this section:

- Members of a DHG must be extension jacks of the same type: all analog or all MLX.
- You can assign up to 32 DHGs or calling groups, or a combination of both types. Each DHG can have a maximum of 20 members and each data station can be a member of only one DHG.
- You can designate particular lines/trunks or pools (Hybrid/PBX mode only) to ring directly into a DHG. However, incoming calls on a given line/trunk can be directed to only one DHG.
- Extension numbers 770 through 791 and 7920 through 7929 are reserved automatically for calling groups and DHGs. If you want to change the extension numbers assigned to a DHG, see the information about reassigning extension numbers described in Chapter 2, "Control Unit Configuration." The same considerations apply to data stations and voice extensions.

Forms Needed

- Form 2a, System Numbering: Extension Jacks
- Form 2c, System Numbering: Line/Trunk Jacks
- If the system has trunk pools, Hybrid/PBX mode only, Form 2c, System Numbering: Line/Trunk Jacks
- If the system includes voice calling groups, Form 7d, Group Calling
- If you plan to renumber the factory-set extensions, Form 2d, System Numbering: Special Renumbers

Planning Form Instructions

Make enough copies of Data Form 2, Data Hunt Groups, for the number of data hunt groups you plan. For each DHG:

1. Write the group number (1–32) in the Group Number space.
2. Write the name of the group in the Group ID space.
3. Write the factory-set extension number for the DHG in the space provided.

NOTE:

Check all pages of Form 7d to be sure that you have not assigned the extension to a voice calling group.

4. If you want to reassign the factory-set extension number for the DHG, write the new number in the Renumber To space. Also write the new extension number you want to reassign in the calling group or DHG on Form 2d, System Numbering: Special Renumber.
5. Under the Purpose of Group heading, indicate the group use: local host computer access workstation, LAN access, and so forth.
6. In the Stations area, write the extension number of each member of the group in the Ext. No. column and the name of the person or location in the Person or Location column.
7. In the Trunks or Pool area, for each line/trunk or pool that you want to ring directly into the DHG, write the line/trunk number or pool extension number next to the logical ID in the Trunk or Pool column. (See Form 2b for the line/trunk numbers and Form 2c for the pool extension number.)

Digital Data/Video Stations

Use these instructions if the system has digital data/video endpoints.

Digital data/video endpoints provide access to voice, as well as high speed digital data and video services over PRI, NI-1 BRI, or T1 Switched 56 facilities. Incoming data/video calls may be received using:

- Dial Plan Routing (PRI and T1 Switched 56 Data)
- Tie Line Routing (PRI and T1 Switched 56 Data)
- DFTs

Outgoing data/video calls may be placed using:

- Pool Access
- Automatic Route Selection (ARS)
- DFTs

For more information, see the "Planning Overview," earlier in this chapter.

Forms Needed

- Form 2a, System Numbering: Extension Jacks
- Data Form 3, Digital Data/Video Stations

Planning Form Instructions

Make enough copies of Data Form 3, Digital Data/Video Stations, for the number of digital data/video stations you plan. For each:

1. From Form 2a, System Numbering: Extension Jacks, obtain the identification information for each digital data/video station.
2. Record the information on Data Form 3, Digital Data/Video Stations.
 - a. In the Logical ID space, write the logical ID for each extension.
 - b. In the Extension No. space, write the extension number for each extension.
 - c. In the Equipment, Person, Location space, write the type of data/video endpoint, the name of the person or the location of the equipment.
3. In the Data/Video Type space, place a check mark in the 1B or 2B column to indicate whether this endpoint uses one or two B-channels.

4. In the Digital Facilities space, enter the method used to access incoming and outgoing facilities.
 - a. In the Digital Facilities In space, enter one of the following for incoming data/video calls:
 1. If DFTs are used to receive data/video calls, enter the line/trunk number for each DFT. For example, **801/802**.
 2. If Dial Plan Routing is used to route incoming data/video calls (PRI and T1 Switched 56 facilities only), enter **Dial Plan Routing**.
 3. If Tie Line Routing is used to route incoming data/video calls (PRI and T1 Switched 56 facilities only), enter **Tie Line Routing**.
 - b. In the Digital Facilities Out space, enter one of the following for outgoing data/video calls:
 1. If DFTs are used to place outgoing data/video calls, enter the line/trunk number for each DFT. For example, **801/802**.
 2. If Pool Access is used to place outgoing data/video calls, enter the pool access number. For example, **890**.
 3. If Automatic Route Selection (ARS) is used to place outgoing data/video calls, enter the ARS access code. The default ARS access code is **9**.
5. If an MLX telephone is connected to a desktop video system in a Passive Bus arrangement, indicate this in the Passive Bus space. Enter the extension number of the passive bus MLX set.

Modifications

6

Contents

Preparation	6-2
Adding to the System	6-2

This chapter contains instructions for adding trunks, auxiliary equipment, or more telephones to an existing system. It includes the following:

- The actions that you must take to add to the system
- The interrelated options or features that you should consider
- The forms that must be revised or completed

To modify the system, perform the following tasks:

1. Decide what to change and identify the programming needed.
2. Complete (or revise) the appropriate planning forms.
3. Program the modification using instructions in *System Programming*.

Preparation

To prepare for modifying the system:

1. Collect the package of completed planning forms. Although you may need to revise only one or two forms, you should have all completed forms available for reference. If you need clean copies of the forms, see Appendix B of the *Equipment and Operations Reference*.
2. Review Chapter 1, "Before You Begin," for details on preparation for planning activities.
3. Before revising the forms, analyze and document the changes planned. For example:
 - If adding extensions to the system, revise the floor plan to show the location of the new telephones and the kind of equipment to be used.
 - If activating a feature such as System Speed Dial, survey employees to identify the numbers that should be programmed into the speed dial file.
4. Review security information in Appendix A, "Customer Support Information," for details on how to minimize the risk of toll fraud.

Adding to the System

Adding to the system is defined as increasing its capacity or capability. This increase may mean adding more or different kinds of lines/trunks, connecting auxiliary equipment, or installing more telephones, consoles, or T/R equipment.

Forms Needed

- Form 1, System Planning
- Form 2a, System Numbering: Extension Jacks
- Form 2c, System Numbering: Line/Trunk Jacks

Planning Form Instructions

1. Determine the specific type of line/trunk, auxiliary equipment, or telephones to be added. Use Table 6–1 to determine the type of line/trunk and/or extension module needed to support what you plan to add.

Table 6-1. Required Line/Trunk and/or Extension Modules

Module	100D	800	400	400	400	800	800	008	800	800	008	008	012	016	408	408	408
	CO-	EM	GS/	GS/	DID	OPT	GS/	GS/	MLX	MLX	MLX	MLX	MLX	MLX	MLX	MLX	MLX
	BRI		LS	LS		LS	LS-ID										
LS trunks																	
GS trunks																	
Tie trunks																	
DID trunks																	
T1 service																	
Emulated LS trunks																	
Emulated GS trunks																	
Emulated Tie trunks																	
PRI services																	
T1 Switched 56 service																	
NI-1 BRI services																	
Remote Access																	
Loudspeaker Paging																	
Maintenance Alarm																	
Music On Hold																	
MLX DLC																	
OCC																	
Analog DLC																	
MLX telephone																	
Analog multiline telephone																	
Tip/ring equipment																	
Off-premises telephone																	

NOTES:

1. DS1 connectivity configured for T1 operation provides 24 channels.
2. T1-Tie trunks may be configured to use Switched 56 service.
3. NI-1 BRI service provides 16 channels per 800 NI-BRI module.
4. If you are planning for Remote Access, at least one module with touch-tone receivers (TTRs) must be installed.
5. If analog multiline telephones require either voice and data or Voice Announce to Busy, two consecutive telephone jacks are required.
6. If you are connecting T/R equipment to the 008, 408, or 408 GS/LS modules, a GPA is required.

2. On Form 1 (page 2), System Planning, review the completed Control Unit Diagram and determine whether the module type needed is present. Do *one* of the following:
 - If the module is not in the control unit, skip to Step 4.
 - If the module type needed is already in the control unit, proceed to Step 3.
3. Determine whether there are jacks available on the module for the new line/trunk, auxiliary equipment, or telephone by referring to Form 2a, System Numbering: Extension Jacks, or Form 2c, System Numbering: Line/Trunk Jacks. Do *one* of the following:
 - If there are sufficient jacks available on an existing module, plan to connect the added line/trunk, equipment or telephone to them. Skip to Step 6.
 - If no jacks are available, proceed to Step 4.
4. Plan the placement of the new module required to support the line/trunk, auxiliary equipment, or telephone by reviewing the guidelines that follow and deciding where the new module should be placed.
 - The power supply module must be placed in the far left slot of each carrier.
 - The processor module must be installed in Slot 0 of the basic carrier.
 - Line/trunk and/or extension modules can be placed in any order in Slots 1 through 17 (with two expansion carriers), with the following conditions:
 - Install the modules in each carrier from left to right, with no empty slots between modules.
 - If the system includes a QCC, the 008 MLX module that supports it must be the first extension module in the control unit.
 - Place all older 008 OPT modules (Apparatus Codes 517A28–517C28) and 012 modules (Apparatus Codes from 517C13–517F13) in carriers with ring generators installed in the power supply module. Current versions of 008 OPT modules (Apparatus Code 517D28), 012 modules [Apparatus Code 517G13(28)], and 016 modules (Apparatus Code 517A34) have built-in ring generators and can be mixed in carriers with the older modules that already have a generator in place.

5. Do *one* of the following:

NOTE:

Placing additional modules in the control unit requires a recalculation of unit loads. For instructions, see Appendix F and the *Equipment and Operations Reference*.

- If the control unit has an available slot to the right, and the guidelines permit placement there, proceed to Step 6.
 - If you must rearrange existing modules to accommodate the new one, skip to Step 7.
6. Revise or complete the required planning form(s) according to the directions shown in Tables 6–2, 6–3, and 6–4.
 7. If you rearrange modules in the control unit, the numbering plan reverts to the factory-set 2-digit plan. You must then reprogram the system:
 - a. Obtain a blank set of planning forms; copy them from Appendix B of this book or order them using information found in Appendix B of the *Equipment and Operations Reference*.
 - b. Locate the Equipment List (if available), the local telephone company line/trunk information list, the floor plan, and the analysis of the Employee Communications Survey forms. If any of these materials have been revised, find both the original and revised versions.
 - c. Work through *System Planning*, beginning with Chapter 2, "Control Unit Configuration."

When you have completed modifying existing forms or completing new forms, program the modification(s) following the instructions in *System Programming*.

Table 6-2. Adding New Trunks

If Adding	Complete these Forms
Loop-start or ground-start trunks	All columns of Form 2c, System Numbering: Line/Trunk Jacks
DS1 trunks	All Columns of Form 2c, System Numbering: Line/Trunk Jacks and Form 3b, Incoming Trunks: DS1 Connectivity (100D Module)
NI-1 BRI trunks	All Columns of Form 2c, System Numbering: Line/Trunk Jacks and Form 3i, Incoming Trunks: BRI Options (800 NI-BRI Module)
Tie trunks	All columns of Form 2c, System Numbering: Line/Trunk Jacks and Form 3c, Incoming Trunks: Tie
DID facilities	All columns of Form 2c, System Numbering: Line/Trunk Jacks and Form 3d, Incoming Trunks: DID Consider revisions to Form 3a, Incoming Trunks: Remote Access. Consider revisions to Form 2c, System Numbering: Line/Trunk Jacks (labels) and Forms 3e through 3g for ARS. Button Diagram on copies of Forms 4a through 4f, and 5a through 5d If a personal line is assigned, consider Remote Call Forwarding.

Table 6-3. Adding Auxiliary Equipment

If Adding	Complete
Maintenance Alarm Music On Hold Loudspeaker Paging	Form 2c, System Numbering: Line/Trunk Jacks

Table 6-4. Adding New Extensions

If Adding	Complete
New Extensions	All columns of Form 2a, System Numbering: Extension Jacks Copy of appropriate telephone/operator Forms 4a through 4f, and 5a through 5d Consider revisions to: Group Assigned Features (Forms 7a through 7d) Allowed and Disallowed List assignments (Forms 6e and 6f) Night Service assignments (Forms 9a through 9c) Extension Labels (Form 2a)
Operator console	Consider revisions to: Optional Operator Features (Form 6a) Extension Status assignment (Form 8a)

Upgrading

7

Contents

Upgrading to Release 4.0	7-2
■ Upgrade Overview	7-2
■ Compatibility	7-3
Release 4.0 Forms	7-4

**WARNING:**

Installation or maintenance of this product by anyone other than qualified personnel may damage or impair the product; your limited warranty does not cover such damage. For details, see your limited warranty in Appendix A, "Customer Support Information." Hazardous electrical voltages are present inside this product.

This chapter contains information about upgrading the system to Release 4.0. You can perform the following upgrades:

- From Release 1.0 to Release 4.0
- From Release 1.1 to Release 4.0
- From Release 2.0 to Release 4.0
- From Release 2.1 to Release 4.0
- From Release 3.0 to Release 4.0

MERLIN II Communications System programming cannot be upgraded to this communications system. Any upgrades from MERLIN II must be considered a new installation to MERLIN LEGEND.

Upgrading to Release 4.0

This section contains an overview of upgrading from Releases 1.0, 1.1, 2.0, 2.1, and 3.0 to Release 4.0.

Although there are hardware modifications incorporated in Release 4.0, you can still use the SPM software, available in both DOS and UNIX System® (IS II or IS III) versions. However, once the system is upgraded to Release 4.0, SPM is no longer required for subsequent upgrades.

Upgrade Overview

You must perform the following tasks when upgrading to Release 4.0:

1. Install SPM Version 4.15 or later to back up and convert system programming information, and to restore system programming information after the Release 4.0 processor module has been installed.
2. Back up the system programming.
3. Install a Release 4.0 processor.
4. Perform a System Erase (frigid start).
5. Convert the backup file to Release 4.0 format.
6. Restore the system programming.
7. Program new features.

For more detailed information and procedures (including error conditions and recovery as well as procedures for translation conversion), see *Maintenance and Troubleshooting*, *System Programming and Maintenance* and *System Programming*.

Compatibility

It is important to understand the compatibility between files created on each of the different versions of SPM, not only for upgrading, but also for programming. Table 7–1 summarizes programming compatibility.

Table 7–1. Programming Compatibility

SPM Version	Program Backup on	Restore on				
		1.0	1.1	2.0/ 2.1	3.0	4.0
1.13	1.0	yes	no	no	no	no
1.16	1.0	yes	yes	no	no	no
2.09	1.0	yes	yes	yes*	no	no
2.16	1.0	yes	yes	yes*	no	no
3.18	1.0	yes	yes	yes*	yes*	no
4.15	1.0	yes	yes	yes*	yes*	yes*
1.16	1.1	no	yes	no	no	no
2.09	1.1	no	yes	yes*	no	no
2.16	1.1	no	yes	yes*	no	no
3.18	1.1	no	yes	yes*	yes*	no
4.15	1.1	no	yes	yes*	yes*	yes*
2.09	2.0	no	no	yes	no	no
2.16	2.0	no	no	yes	no	no
3.18	2.0	no	no	yes	yes*	no
4.15	2.0	no	no	yes	yes*	yes*
2.16	2.1	no	no	yes	no	no
3.18	2.1	no	no	yes	yes*	no
4.15	2.1	no	no	yes	yes*	yes*
3.18	3.0	no	no	no	yes	no
4.15	3.0	no	no	no	yes	yes*
4.15	4.0	no	no	no	no	yes

* The backup file must be converted before it is restored.

Release 4.0 Forms

Significant changes were made to the planning forms for Release 3.0 (as described in Release 3.0 *System Planning*) to reflect enhancements made for Release 4.0.

Table 7-2 compares the planning forms for each major release.

Table 7-2. Planning Forms

1.0	2.0	3.0	4.0	4.0 Form Title
N/A	N/A			Employee Communication Survey
1	1	1	1	System Planning
2a	2a	2a	2a	System Numbering: Extension Jacks
2b	2b	2b	2b	System Numbering: Digital Adjuncts
2c	2c	2c	2c	System Numbering: Line/Trunk Jacks
2d	2d	2d	2d	System Numbering: Special Renumbers
2e				(1.0 form Technician's Run Sheet now included on Form 2c)
3a	3a	3a	3a	Incoming Trunks: Remote Access
3b				(1.0 form Incoming Trunks—Pools now included on Form 2a)
3c	3b	3b	3b	Incoming Trunks: DS1 Connectivity (100D Module)
3d	3c	3c	3c	Incoming Trunks: Tie
3e	3d	3d	3d	Incoming Trunks: DID
		3e	3e	Automatic Route Selection Worksheet
		3f	3f	Automatic Route Selection Tables
		3g	3g	Automatic Route Selection Default and Special Numbers Tables
		3h	3h	LS-ID Delay
			3i	Incoming Trunks: BRI Options (800 NI-BRI Module)
	4a	4a	4a	Extension Copy: Analog Multiline Telephone Template
4a	4b	4b	4b	Analog Multiline Telephone
	4c	4c	4c	Extension Copy: MLX Telephone Template
4b	4d	4d	4d	MLX Telephone
4b	4e	4e	4e	MFM Adjunct: MLX Telephone
4c	4f	4f	4f	Tip/Ring Equipment
5a	5a	5a	5a	Direct-Line Console (DLC): Analog
5b	5b	5b	5b	Direct-Line Console (DLC): Digital
5b	5c	5c	5c	MFM Adjunct: DLC
5c	5d	5d	5d	Queued Call Console (QCC)
6a	6a	6a	6a	Optional Operator Features
		6b	6b	Optional Extension Features
		6c	6c	Principal User of Personal Line
		6d	6d	Message-Waiting Receivers
		6e	6e	Allowed Lists
		6f	6f	Disallowed Lists
		6g	6g	Call Restriction Assignments and Lists
		6h	6h	Authorization Codes

Continued next page

Table 7-2, Continued

1.0	2.0	3.0	4.0	4.0 Form Title
		6i	6i	Pool Dial-Out Code Restrictions
6b	6b			Call Pickup Groups
6c	6c			Group Paging
6d	6d			Group Coverage
6e	6e			Group Calling
6f	6f			System Features
6g	6g			Allowed Lists
6h	6h			Disallowed Lists
		6i		Call Restriction Assignments and Lists
7a	7a			Night Service: Group Assignment
		7a	7a	Call Pickup Groups
7b	7b			Night Service: Outward Restriction
		7b	7b	Group Paging
7c	7c			Night Service: Time Set
		7c	7c	Group Coverage
		7d	7d	Group Calling
8a				(1.0 form, Label Form—Trunks, now included on Form 2c)
		8a	8a	System Features
8b				(1.0 form, Label Form—Stations and Calling Groups, now included on Form 2a)
8c	8a			Label Form: Posted Message
8d	8b			System Speed Dial
9a	9a			Automatic Route Selection Worksheet
		9a	9a	Night Service: Group Assignment
9b	9b			Automatic Route Selection Tables
		9b	9b	Night Service: Outward Restriction
9c	9c			Automatic Route Selection Default and Special Numbers Tables
		9c	9c	Night Service: Time Set
		10a	10a	Label Form: Posted Message
		10b	10b	System Speed Dial

Customer Support Information

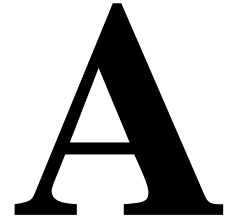

Support Telephone Number

In the U.S.A. only, AT&T provides a toll-tree customer Helpline (1 800 628-2888) 24 hours a day. If you need assistance when installing, programming, or using your system, call the Helpline, or your AT&T representative. Consultation charges may apply.

Outside the U.S.A., if you need assistance when installing, programming, or using your system, contact your AT&T representative.

Federal Communications Commission (FCC) Electromagnetic Interference Information

This equipment has been tested and found to comply with the limits for a Class A digital device, pursuant to Part 15 of the FCC Rules. These limits are designed to provide reasonable protection against harmful interference when the equipment is operated in a commercial environment. This equipment generates, uses, and can radiate radio frequency energy and, if not installed and used in accordance with the instruction manual, may cause harmful interference to radio communications. Operation of this equipment in a residential area is likely to cause harmful interference, in which case the user will be required to correct the interference at his or her own expense.

Canadian Department of Communications (DOC) Interference Information

This digital apparatus does not exceed the Class A limits for radio noise emissions set out in the radio interference regulations of the Canadian Department of Communications.

Le Présent Appareil Numérique n'émet pas de bruits radioélectriques dépassant les limites applicables aux appareils numériques de la class A prescrites dans le règlement sur le brouillage radioélectrique edicté par le ministère des Communications du Canada.

FCC Notification and Repair Information

This equipment is registered with the FCC in accordance with Part 68 of its rules. In compliance with those rules, you are advised of the following:

- **Means of Connection.** Connection of this equipment to the telephone network shall be through a standard network interface jack, USOC RJ11C, RJ14C, RJ21X. Connection to E&M tie trunks requires a USOC RJ2GX. Connection to off-premises extensions requires a USOC RJ11C or RJ14C. Connection to 1.544-Mbps digital facilities must be through a USOC RJ48C or RJ48X. Connection to DID requires a USOC RJ11C, RJ14C, or RJ21X. These USOCs must be ordered from your telephone company. Connection to 56-Kbps or 64-Kbps facilities requires a USOC RJ11C, RJ14C, or RJ21.
- **Party Lines and Coin Telephones.** This equipment may not be used with party lines or coin telephone lines.
- **Notification to the Telephone Companies.** Before connecting this equipment, you or your equipment supplier must notify your local telephone company's business office of the following:
 - The telephone number(s) you will be using with this equipment.
 - The appropriate registration number and ringer equivalence number (REN), which can be found on the back or bottom of the control unit, as follows:
 - If this equipment is to be used as a Key system, report the number AS593M-72914-KF-E.
 - If the system provides both manual and automatic selection of incoming/outgoing access to the network, report the number AS593M-72682-MF-E.

- If there are no directly terminated trunks, or if the only directly terminated facilities are personal lines, report the number AS5USA-65646-PF-E.
- The REN (Ringer Equivalence Number) for all three systems is 1.5A.
- The facility interface code (FIC) and service order code (SOC):
 - For tie line connection, the FIC is TL31M and the SOC is 9.0F.
 - For connection to off-premises stations, the FIC is OL13C and the SOC is 9.0F.
 - For equipment to be connected to DID facilities, the FIC is 02RV2-T and the SOC is AS.2.
 - For equipment to be connected to 1.544-Mbps digital service, the SOC is 6.0P and the FIC is:
 - 04DU9-BN for D4 framing format with AMI zero code suppression.
 - 04DU9-DN for D4 framing format with bipolar 8 zero code suppression (B8ZS).
 - 04DU9-IKN for extended superframe format (ESF) with AMI zero code suppression.
 - 04DU9-ISN with ESF and B8ZS.
 - For equipment to be connected to 56-Kbps or 64-Kbps digital facilities, the FIC is 02B1Q.
- The quantities and USOC numbers of the jacks required.
- For each jack, the sequence in which lines are to be connected, the line types, the FIC, and the REN by position when applicable.
- **Ringer Equivalence Number (REN).** The REN is used to determine the number of devices that may be connected to the telephone line. Excessive RENs on the line may result in the devices not ringing in response to an incoming call. In most, but not all, areas the sum of the RENs should not exceed five (5.0). To be certain of the number of devices that may be connected to the line, as determined by the total RENs, contact the local telephone company to determine the maximum REN for the calling area.
- **Disconnection.** You must also notify your local telephone company if and when this equipment is permanently disconnected from the line(s).

Installation and Operational Procedures

The manuals for your system contain information about installation and operational procedures.

- **Repair Instructions.** If you experience trouble because your equipment is malfunctioning, the FCC requires that the equipment not be used and that it be disconnected from the network until the problem has been corrected. Repairs to this equipment can be made only by the manufacturers, their authorized agents, or others who may be authorized by the FCC. In the event repairs are needed on this equipment, contact your authorized AT&T dealer or, **in the U.S.A. only**, contact the National Service Assistance Center (NSAC) at 1 800 628-2888.
- **Rights of the Local Telephone Company.** If this equipment causes harm to the telephone network, the local telephone company may discontinue your service temporarily. If possible, they will notify you in advance. But if advance notice is not practical, you will be notified as soon as possible. You will also be informed of your right to file a complaint with the FCC.
- **Changes at Local Telephone Company.** Your local telephone company may make changes in its facilities, equipment, operations, or procedures that affect the proper functioning of this equipment. If they do, you will be notified in advance to give you an opportunity to maintain uninterrupted telephone service.
- **Hearing Aid Compatibility.** The custom telephone sets for this system are compatible with inductively coupled hearing aids as prescribed by the FCC.
- **Automatic Dialers.** WHEN PROGRAMMING EMERGENCY NUMBERS AND/OR MAKING TEST CALLS TO EMERGENCY NUMBERS:
 - Remain on the line and briefly explain to the dispatcher the reason for the call.
 - Perform such activities in off-peak hours, such as early morning or late evening.
- **Direct Inward Dialing (DID).** This equipment returns answer supervision signals to the Public Switched Telephone Network when:
 - Answered by the called station
 - Answered by the attendant
 - Routed to a recorded announcement that can be administered by the customer premises equipment user
 - Routed to a dial prompt

This equipment returns answer supervision on all DID calls forwarded back to the Public Switched Telephone Network. Permissible exceptions are when:

- A call is unanswered
- A busy tone is received
- A reorder tone is received

Allowing this equipment to be operated in such a manner as not to provide proper answer supervision signaling is in violation of Part 68 rules.

New Network Area and Exchange Codes. The MERLIN LEGEND software does not restrict access to any new area codes or exchange codes established by a local telephone company. If the user has established toll restrictions on the system that could restrict access, then the user should check the lists of allowed and disallowed dial codes and modify them as needed.

Equal Access Codes. This equipment is capable of providing users access to interstate providers of operator services through the use of access codes. Modifications of this equipment by call aggregators to block access dialing codes is a violation of the Telephone Operator Consumers Act of 1990.

DOC Notification and Repair Information

NOTICE: The Canadian Department of Communications (DOC) label identifies certified equipment. This certification means that the equipment meets certain telecommunications network protective, operational, and safety requirements. The DOC does not guarantee the equipment will operate to the user's satisfaction.

Before installing this equipment, users should ensure that it is permissible to connect it to the facilities of the local telecommunications company. The equipment must also be installed using an acceptable method of connection. In some cases, the company's inside wiring for single-line individual service may be extended by means of a certified connector assembly (telephone extension cord). The customer should be aware that compliance with the above conditions may not prevent degradation of service in some situations.

Repairs to certified equipment should be made by an authorized Canadian maintenance facility designated by the supplier. Any repairs or alterations made by the user to this equipment, or any equipment malfunctions, may give the telecommunications company cause to request the user to disconnect the equipment.

Users should ensure for their own protection that the electrical ground connections of the power utility, telephone lines, and internal metallic water pipe system, if present, are connected. This precaution may be particularly important in rural areas.



CAUTION:

Users should not attempt to make such connections themselves, but should contact the appropriate electrical inspection authority or electrician, as appropriate.

To prevent overloading, the Load Number (LN) assigned to each terminal device denotes the percentage of the total load to be connected to a telephone loop used by the device. The termination on a loop may consist of any combination of devices subject only to the requirement that the total of the Load Numbers of all the devices does not exceed 100.

DOC Certification No.: 230 4095A

CSA Certification No.: LR 56260

Load No.: 6

Renseignements sur la notification du ministère des Communications du Canada et la réparation

AVIS: L'étiquette du ministère des Communications du Canada identifie le matériel homologué. Cette étiquette certifie que le matériel est conforme à certaines normes de protection, d'exploitation et de sécurité des réseaux de télécommunications. Le Ministère n'assure toutefois pas que le matériel fonctionnera à la satisfaction de l'utilisateur.

Avant d'installer ce matériel, l'utilisateur doit s'assurer qu'il est permis de le raccorder aux installations de l'entreprise locale de télécommunication. Le matériel doit également être installé en suivant une méthode acceptée de raccordement. Dans certains cas, les fils intérieurs de l'entreprise utilisés pour un service individuel à ligne unique peuvent être prolongés au moyen d'un dispositif homologué de raccordement (cordon prolongateur téléphonique interne). L'abonné ne doit pas oublier qu'il est possible que la conformité aux conditions énoncées ci-dessus n'empêchent pas la dégradation du service dans certaines situations. Actuellement, les entreprises de télécommunication ne permettent pas que l'on raccorde leur matériel à des jacks d'abonné, sauf dans les cas précis prévus par les tarifs particuliers de ces entreprises.

Les réparations de matériel homologué doivent être effectuées par un centre d'entretien canadien autorisé désigné par le fournisseur. La compagnie de télécommunications peut demander à l'utilisateur de débrancher un appareil à la suite de réparations ou de modifications effectuées par l'utilisateur ou à cause de mauvais fonctionnement.

Pour sa propre protection, l'utilisateur doit s'assurer que tous les fils de mise à la terre de la source d'énergie électrique, des lignes téléphoniques et des canalisations d'eau métalliques, s'il y en a, sont raccordés ensemble. Cette précaution est particulièrement importante dans les régions rurales.

AVERTISSEMENT: L'utilisateur ne doit pas tenter de faire ces raccordements lui-même; il doit avoir recours à un service d'inspection des installations électriques, ou à un electricien, selon le cas.

L'indice de charge (IC) assigné à chaque dispositif terminal indique, pour éviter toute surcharge, le pourcentage de la charge totale qui peut être raccordée à un circuit téléphonique bouclé utilisé par ce dispositif. La terminaison du circuit bouclé peut être constituée de n'importe quelle combinaison de dispositifs, pourvu que la somme des indices de charge de l'ensemble des dispositifs ne dépasse pas 100.

No d'homologation: 230 4095A

No de certification: CSA LR 56260

L'indice de charge: 6

**MERLIN LEGEND D.O.C.
Location Label Placement**

**Ministère des Communications
du Canada emplacement de
l'étiquette**



MERLIN LEGEND

Model 511A Control Unit



**TELEPHONE
EQUIPMENT**

LR 56260

LISTED 538E



MADE IN U.S.A.

Complies with Part 68, FCC Rules. See the System Reference Manual for proper FCC Classification.
 FCC Reg. Nos. MF: AS593M-72682-MFE
 KF: AS593M-72914-KF-E
 PF: AS593M-65646-PF-E
 REN: 1.5A

This device complies with Part 15 of the FCC Rules. Operation is subject to the following two conditions: (1) this device may not cause harmful interference, and (2) this device must accept any interference received, including interference that may cause undesired operation.

WARNING: If equipment is used for out-of-building applications, approved secondary protectors are required. See Installation Manual.

AVERTISSEMENT: Si l'équipement est utilisé pour des applications extérieures, l'installation d'un protecteur secondaire est requise. Voir le manuel d'installation.

Use only AT&T manufactured MERLIN LEGEND circuit modules, carrier assemblies, and power units, as specified in the Installation Manual, in this product. There are no user serviceable parts inside. Contact your authorized agent for service and repair.

This digital apparatus does not exceed the Class A limits for radio noise emissions set out in the radio interference regulations of the Canadian Department of Communications.

Le présent appareil numérique n'émet pas de bruits radioélectriques dépassant les limites applicables aux appareils numériques de la classe A prescrites dans le Règlement sur le brouillage radioélectrique édicté par le ministère des Communications du Canada.

CANADA

DR ID

Security of Your System: Preventing Toll Fraud

As a customer of a new telephone system, you should be aware that there is an increasing problem of telephone toll fraud. Telephone toll fraud can occur in many forms, despite the numerous efforts of telephone companies and telephone equipment manufacturers to control it. Some individuals use electronic devices to prevent or falsify records of these calls. Others charge calls to someone else's number by illegally using lost or stolen calling cards, billing innocent parties, clipping on to someone else's line, and breaking into someone else's telephone equipment physically or electronically. In certain instances, unauthorized individuals make connections to the telephone network through the use of the Remote Access features of your system.

The Remote Access features of your system, if you choose to use them, permit off-premises callers to access the system from a remote telephone by using a telephone number with or without a barrier code. The system returns an acknowledgment signaling the user to key in his or her barrier code, which is selected and administered by the system manager. After the barrier code is accepted, the system returns dial tone to the user. In Release 3.1 and later systems, barrier codes are by default restricted from making outside calls. In prior releases, if you do not program specific outward calling restrictions, the user will be able to place any call normally dialed from a telephone associated with the system. Such an off-premises network call is originated at, and will be billed from, the system location.

The Remote Access feature, as designed, helps the customer, through proper administration, to minimize the ability of unauthorized persons to gain access to the network. Most commonly, phone numbers and codes are compromised when overheard in a public location, through theft of a wallet or purse containing access information, or through carelessness (for example, writing codes on a piece of paper and improperly discarding it). Additionally, hackers may use a computer to dial an access code and then publish the information to other hackers. Enormous charges can be run up quickly. It is the customer's responsibility to take the appropriate steps to properly implement the features, evaluate and administer the various restriction levels, protect access codes, and distribute access codes only to individuals who have been fully advised of the sensitive nature of the access information.

Common carriers are required by law to collect their tariffed charges. While these charges are fraudulent charges made by persons with criminal intent, applicable tariffs state that the customer of record is responsible for payment of all long-distance or other network charges. AT&T cannot be responsible for such charges and will not make any allowance or give any credit for charges that result from unauthorized access.

To minimize the risk of unauthorized access to your communications system:

- Use a nonpublished Remote Access number.
- Assign access codes randomly to users on a need-to-have basis, keeping a log of *all* authorized users and assigning one code to one person.
- Use random-sequence access codes, which are less likely to be easily broken.
- Use the longest-length access codes the system will allow.
- Deactivate all unassigned codes promptly.
- Ensure that Remote Access users are aware of their responsibility to keep the telephone number and any access codes secure.
- When possible, restrict the off-network capability of off-premises callers, using calling restrictions, Facility Restriction Levels (Hybrid/PBX mode only), and Disallowed List capabilities. In Release 3.1 and later systems, a prepared Disallowed List (number 7) is provided and is designed to prevent the types of calls that toll-fraud abusers often make.
- When possible, block out-of-hours calling.
- Frequently monitor system call detail reports for quicker detection of any unauthorized or abnormal calling patterns.
- Limit Remote Call Forwarding to persons on a need-to-have basis.
- Change access codes every 90 days.
- Use the longest-length barrier codes possible, following the guidelines for passwords. (See "Choosing Passwords.")

Toll Fraud Prevention

Toll fraud is the unauthorized use of your telecommunications system by third parties to make long distance telephone calls. Under the law, you, the customer, are responsible for paying part or all of those unauthorized calls. Thus, the following information is of critical importance.

Unauthorized persons concentrate their activities in two areas with the MERLIN LEGEND Communications System:

- They try to transfer out of the MERLIN LEGEND Communications System to gain access to an outgoing trunk and make long distance calls.
- They try to locate unused or unprotected mailboxes and use them as drop-off points for their own messages.

The following is a discussion of how toll fraud is often perpetrated and ways to prevent unauthorized access that can lead to toll fraud.

Physical Security, Social Engineering, and General Security Measures

Criminals called *hackers* may attempt to gain unauthorized access to your communications system and voice messaging system in order to use the system features. Hackers often attempt to trick employees into providing them with access to a network facility (line/trunk) or a network operator. This is referred to as social engineering. Hackers may pose as telephone company employees and employees of AT&T or your authorized dealer. Hackers will go through a company's trash to find directories, dialing instructions, and other information that will enable them to break into the system. The more knowledgeable they appear to be about the employee names, departments, telephone numbers, and the internal procedures of your company, the more likely it is that they will be able to trick an employee into helping them.

Preventive Measures

Take the following preventive measures to limit the risk of unauthorized access by hackers:

- Provide good physical security for the room containing your telecommunications equipment and the room with administrative tools, records, and system manager information. These areas should be locked when not attended.
- Provide a secure trash disposal for all sensitive information, including telephone directories, call accounting records, or anything that may supply information about your communications system. This trash should be shredded.
- Educate employees that hackers may try to trick them into providing them with dial tone or dialing a number for them. All reports of trouble, requests for moving extensions, or any other administrative details associated with the MERLIN LEGEND Communications System should be handled by one person (the system manager) or within a specified department. Anyone claiming to be a telephone company representative should be referred to this person or department.

- No one outside of AT&T needs to use the MERLIN LEGEND Communications System to test facilities (lines/trunks). If a caller identifies him or herself as an AT&T employee, the system manager should ask for a telephone number where the caller can be reached. The system manager should be able to recognize the number as an AT&T telephone number. *Before connecting the caller to the administrative port of the MERLIN LEGEND Communications System, the system manager should feel comfortable that a good reason to do so exists.* In any event, it is not advisable to give anyone access to network facilities or operators, or to dial a number at the request of the caller.
- Any time a call appears to be suspicious, call the AT&T GBCS Fraud Intervention Center at 1 800 628-2888 (fraud intervention for System 25, PARTNER[®] and MERLIN[®] systems).
- Customers should also take advantage of AT&T monitoring services and devices, such as the NetPROTECTSM family of fraud detection services, CAS with HackerTracker[®], and CAT Terminal with Watchdog. Call 1 800 638-7233 to get more information on these AT&T fraud detection services and products.

Security Risks Associated with Transferring through voice messaging systems

Toll fraud hackers try to dial into a voice mailbox and then execute a transfer by dialing * T. The hacker then dials an access code (either 9 for Automatic Route Selection or a pooled facility code) followed by the appropriate digit string to either direct dial or access a network operator to complete the call.

NOTE:

In Release 3.1 and later systems, all extensions are initially and by default restricted from dial access to pools. In order for an extension to use a pool to access an outside line/trunk, this restriction must be removed.

Preventive Measures

Take the following preventive measures to limit the risk of unauthorized transfers by hackers:

- Outward restrict all MERLIN LEGEND voice mail port extensions. This denies access to facilities (lines/trunks). In Release 3.1 and later systems, voice mail ports are by default outward restricted.
- As an additional security step, network dialing for all extensions, including voice mail port extensions, should be processed through ARS using dial access code 9

 **Security Alert:**

The MERLIN LEGEND system ships with ARS activated with all extensions set to Facility Restriction Level 3, allowing all international calling. **To prevent toll fraud**, ARS Facility Restriction Levels (FRLs) should be established using:

- FRL 0 for restriction to internal dialing only
- FRL 2 for restriction to local network calling only
- FRL 3 for restriction to domestic long distance (excluding area code 809 for the Dominican Republic as this is part of the North American Numbering Plan, unless 809 is required)
- FRL 4 for international calling

In Release 3.1 and later systems, default local and default toll tables are factory-assigned an FRL of 2. This simplifies the task of restricting extensions: the FRL for an extension merely needs to be changed from the default of 3.

Each extension should be assigned the appropriate FRL to match its calling requirements. **All voice mail port extensions not used for Outcalling should be assigned to FRL 0 (the default setting in Release 3.1 and later).**

- Deny access to pooled facility codes by removing pool dial-out codes 70, 890-899, or any others on your system.
- Create a Disallowed List or use the pre-prepared Disallowed List number 7 (Release 3.1 and later systems only) to disallow dialing 0, 11, 10, 1700, 1809, 1900, and 976 or 1(wildcard)976. In Release 3.1 and later systems, Disallowed List number 7 does not include 800 and 1800 and 411 and 1411, but AT&T recommends that you add them. **Assign all voice mail port extensions to this Disallowed List. AT&T recommends assigning Disallowed List number 7. This is an added layer of security, in case outward restriction is inadvertently removed.** (In Release 3.1 and later systems, voice messaging ports are assigned by default to Disallowed List number 7.)

If Outcalling is required by voice messaging system extensions:

- Program an ARS Facility Restriction Level (FRL) of 2 on voice mail port extension(s) used for Outcalling.
- If 800 and 411 numbers are used, remove 1800, 800, 411, and 1411 from Disallowed List number 7.
- If Outcalling is allowed to long distance numbers, build an Allowed List for the voice mail port extension(s) used for Outcalling. This list should contain the area code and the first three digits of the local exchange telephone numbers to be allowed.

Additional general security for voice messaging systems:

- Use a secure password for the General Mailboxes.
- The default administration mailbox, 9997, must be reassigned to the system manager's mailbox/extension number and securely password protected.
- All voice messaging system users must use secure passwords known only to the user.

Security Risks Associated with the Automated Attendant Feature of voice messaging systems

Two areas of toll fraud risk associated with the Automated Attendant feature of voice messaging systems are the following:

- Pooled facility (line/trunk) access codes are translated to a menu prompt to allow Remote Access. If a hacker finds this prompt, the hacker has immediate access. (In Release 3.1 and later systems, dial access to pools is initially factory-set to restrict all extensions: to allow pool access, this restriction must be removed by the system manager.
- If the Automated Attendant prompts callers to use Remote Call Forwarding (RCF) to reach an outside telephone number, the system may be susceptible to toll fraud. An example of this application is a menu or Submenu that says, "To reach our answering service, select prompt number 5," and transfers a caller to an external telephone number.

Remote Call Forwarding can only be used securely when the central office provides "reliable disconnect" (sometimes referred to as forward disconnect or disconnect supervision), which guarantees that the central office will not return a dial tone after the called party hangs up. In most cases, the central office facility is a loop-start line/trunk which does not provide reliable disconnect. When loop-start lines/trunks are used, if the calling party stays on the line, the central office will return a dial tone at the conclusion of the call, enabling the caller to place another call as if it were being placed from your company. Ground-start trunks provide reliable disconnect and should be used whenever possible.

Preventive Measures

Take the following preventive measures to limit the risk of unauthorized use of the Automated Attendant feature by hackers:

- *Do not* use Automated Attendant prompts for Automatic Route Selection (ARS) Codes or Pooled Facility Codes.
- Assign all unused Automated Attendant Selector Codes to zero, so that attempts to dial these will be routed to the system attendant.

- If Remote Call Forwarding (RCF) is required, MERLIN LEGEND Communications System owners should coordinate with their AT&T Account Team or authorized dealer to verify the type of central office facility used for RCF. If it is a ground-start line/trunk, or if it is a loop-start line/trunk and central office reliable disconnect can be ensured, then nothing else needs to be done.

NOTE:

In most cases these will be loop-start lines/trunks without reliable disconnect. The local telephone company will need to be involved to change the facilities used for RCF to ground start lines/trunks. Usually a charge applies for this change. Also, hardware and software changes may need to be made in the MERLIN LEGEND system. The MERLIN MAIL Automated Attendant feature merely accesses the RCF feature in the MERLIN LEGEND system. Without these changes being made, this feature is highly susceptible to toll fraud. These same preventive measures must be taken if the RCF feature is active for MERLIN LEGEND system extensions whether or not it is accessed by an Automated Attendant menu.

Security Risks Associated with the Remote Access Feature

Remote Access allows the MERLIN LEGEND Communications System owner to access the system from a remote telephone and make an outgoing call or perform system administration, using the network facilities (lines/trunks) connected to the MERLIN LEGEND system. Hackers, scanning the public switched network by randomly dialing numbers with war dialers (a device that randomly dials telephone numbers, including 800 numbers, until a modem or dial tone is obtained), can find this feature, which will return a dial tone to them. They can even employ war dialers to attempt to discover barrier codes.

Preventive Measures

Take the following preventive measures to limit the risk of unauthorized use of the MERLIN LEGEND Communications System Remote Access feature by hackers:

- The Remote Access feature can be abused by criminal toll fraud hackers, if it is not properly administered. Therefore, this feature should not be used unless there is a strong business need.
- It is strongly recommended that customers invest in security adjuncts, which typically use one-time passcode algorithms. These security adjuncts discourage hackers. Since a secure use of the Remote Access feature generally offers savings over credit-card calling, the break-even period can make the investment in security adjuncts worthwhile.

- If a customer chooses to use the Remote Access feature without a security adjunct, then multiple barrier codes should be employed, with one per user if the system permits. The MERLIN LEGEND system permits a maximum of 16 barrier codes.
- The maximum length should be used for each barrier code, and should be changed periodically. Barrier codes, like passwords, should consist of a random, hard-to-guess sequence of digits. While MERLIN LEGEND Release 3.0 permits a barrier code of up to 11 digits, systems prior to Release 3.0 permit barrier codes of up to only four digits.

If Remote Access is used, an upgrade to MERLIN LEGEND Communications System Release 3.0 is encouraged to take advantage of the longer barrier code.

Other Security Hints

Make sure that the Automated Attendant Selector Codes do not permit outside line selection.

Following are a number of measures and guidelines that can help you ensure the security of your communications system and voice messaging system.

Multiple layers of security are always recommended to keep your system secure.

Educating Users

Everyone in your company who uses the telephone system is responsible for system security. Users and attendants/operators need to be aware of how to recognize and react to potential hacker activity. Informed people are more likely to cooperate with security measures that often make the system less flexible and more difficult to use.

- Never program passwords or authorization codes onto Auto Dial buttons. Display telephones reveal the programmed numbers and internal abusers can use the Auto Dial buttons to originate unauthorized calls.
- Discourage the practice of writing down barrier codes or passwords. If a barrier code or password needs to be written down, keep it in a secure place and never discard it while it is active.
- Operators or attendants should tell their system manager if they answer a series of calls where there is silence on the other end or the caller hangs up.
- Users who are assigned voice mailboxes should frequently change personal passwords and should not choose obvious passwords.
- The system manager should advise users with special telephone privileges (such as Remote Access, Outcalling, and Remote Call Forwarding) of the potential risks and responsibilities.

- Be suspicious of any caller who claims to be with the telephone company and wants to check an outside line. Ask for a callback number, hang up and confirm the caller's identity.
- Never distribute the office telephone directory to anyone outside the company; be careful when discarding it (shred the directory).
- Never accept collect telephone calls.
- Never discuss your telephone system's numbering plan with anyone outside the company.

Educating Operators

Operators or attendants need to be especially aware of how to recognize and react to potential hacker activity. To defend against toll fraud, operators should follow the guidelines below:

- Establish procedures to counter *social engineering*. Social engineering is a con game that hackers frequently use to obtain information that may help them gain access to your communications system or voice messaging system.
- When callers ask for assistance in placing outside or long-distance calls, ask for a callback extension.
- Verify the source. Ask callers claiming to be maintenance or service personnel for a callback number. Never transfer to *10 without this verification. Never transfer to extension 900.
- Remove the headset and/or handset when the console is not in use.

Detecting Toll Fraud

To detect toll fraud, users and operators should look for the following:

- Lost voice mail messages, mailbox lockout, or altered greetings
- Inability to log into voice mail
- Inability to get an outside line
- Foreign language callers
- Frequent hang-ups
- Touch-tone sounds
- Caller or employee complaints that the lines are busy
- Increases in internal requests for assistance in making outbound calls (particularly international calls or requests for dial tone)
- Outsiders trying to obtain sensitive information
- Callers claiming to be the "phone" company
- Sudden increase in wrong numbers

Establishing a Policy

As a safeguard against toll fraud, follow these guidelines for your MERLIN LEGEND Communications System and voice messaging system:

- Change passwords frequently (at least quarterly). Changing passwords routinely on a specific date (such as the first of the month) helps users to remember to do so.
- Always use the longest-length password allowed.
- Establish well-controlled procedures for resetting passwords.
- Limit the number of invalid attempts to access a voice mailbox to five or less.
- Monitor access to the MERLIN LEGEND dial-up maintenance port. Change the access password regularly and issue it only to authorized personnel. Disconnect the maintenance port when not in use. (However, this eliminates AT&T's 24-hour maintenance surveillance capability and may result in additional maintenance costs.)
- Create a communications system management policy concerning employee turnover and include these suggestions:
 - Delete all unused voice mailboxes in the voice mail system.
 - If a terminated employee had Remote Access calling privileges and a personal authorization code, remove the authorization code immediately.
 - If barrier codes and/or authorization codes were shared by the terminated employee, these should be changed immediately.
- Regularly back up your MERLIN LEGEND system files to ensure a timely recovery should it be required. Schedule regular, off-site backups.
- Keep the Remote Maintenance Device turned off when not in use by AT&T or your authorized dealer.
- Limit transfers to registered subscribers only.
- Use the Security Violations Notification options (Mailbox Lock or Warning Message) to alert you of any mailbox break-in attempts. Investigate all incidents.
- Review security policies and procedures and keep them up to date.

Choosing Passwords

Passwords should be the maximum length allowed by the system.

Passwords should be hard to guess and should **not** contain:

- All the same numbers (for example, 1111, 666666)
- Sequential characters (for example 123456)
- Numbers that can be associated with you or your business, such as your name, birthday, business name, business address, telephone number, or social security number.
- Words and commonly used names.

Passwords should be changed regularly, at least on a quarterly basis.

Recycling old passwords is not recommended. Never program passwords (or authorization codes or barrier codes) onto a speed dial button.

Physical Security

You should always limit access to the system console (or attendant console) and supporting documentation. The following are some recommendations:

- Keep the system console and supporting documentation in an office that is secured with a changeable combination lock. Provide the combination only to those individuals having a real need to enter the office.
- Keep telephone wiring closets and equipment rooms locked.
- Keep telephone logs and printed reports in locations that only authorized personnel can enter.
- Design distributed reports so they do not reveal password or trunk access code information.
- Keep the voice messaging system Remote Maintenance Device turned off.

Limiting Outcalling

When Outcalling is used to contact subscribers who are off-site, use the MERLIN LEGEND Communications System Allowed Lists and Disallowed Lists or Automatic Route Selection features to minimize toll fraud.

If the Outcalling feature will not be used, outward restrict all voice messaging system ports. If Outcalling will be used, ports not used for Outcalling should be Outward Restricted (for Merlin Mail Voice Messaging Systems, port 2 on a two-port system, port 4 on a four-port system, ports 5 and 6 on a six-port system). Use Outward Restriction, Toll Restrictions, Allowed Lists, Disallowed Lists and Facility Restrcitions Levels, as appropriate to minimize the possibility of toll fraud.

Limited Warranty and Limitation of Liability

AT&T warrants to you, the customer, that your MERLIN LEGEND Communications System will be in good working order on the date AT&T or its authorized reseller delivers or installs the system, whichever is later ("Warranty Date"). If you notify AT&T or its authorized reseller within one year of the Warranty Date that your system is not in good working order, AT&T will without charge to you repair or replace, at its option, the system components that are not in good working order. Repair or replacement parts may be new or refurbished and will be provided on an exchange basis. If AT&T determines that your system cannot be repaired or replaced, AT&T will remove the system and, at your option, refund the purchase price of your system, or apply the purchase price towards the purchase of another AT&T system.

If you purchased your system directly from AT&T, AT&T will perform warranty repair in accordance with the terms and conditions of the specific type of AT&T maintenance coverage you selected. If you purchased your system from an AT&T-authorized reseller, contact your reseller for the details of the maintenance plan applicable to your system.

This AT&T limited warranty covers damage to the system caused by power surges, including power surges due to lightning.

The following will not be deemed to impair the good working order of the system, and AT&T will not be responsible under the limited warranty for damages resulting from:

- Failure to follow AT&T's installation, operation, or maintenance instructions
- Unauthorized system modification, movement, or alteration
- Unauthorized use of common carrier communication services accessed through the system
- Abuse, misuse, or negligent acts or omissions of the customer and persons under the customer's control
- Acts of third parties and acts of God

AT&T'S OBLIGATION TO REPAIR, REPLACE, OR REFUND AS SET FORTH ABOVE IS YOUR EXCLUSIVE REMEDY.

EXCEPT AS SPECIFICALLY SET FORTH ABOVE, AT&T, ITS AFFILIATES, SUPPLIERS, AND AUTHORIZED RESELLERS MAKE NO WARRANTIES, EXPRESS OR IMPLIED, AND SPECIFICALLY DISCLAIM ANY WARRANTIES OF MERCHANTABILITY OR FITNESS FOR A PARTICULAR PURPOSE.

Limitation of Liability

Except as provided below, the liability of AT&T and its affiliates and suppliers for any claims, losses, damages, or expenses from any cause whatsoever (including acts or omissions of third parties), regardless of the form of action, whether in contract, tort, or otherwise, shall not exceed the lesser of: (1) the direct damages proven; or (2) the repair cost, replacement cost, license fee, annual rental charge, or purchase price, as the case may be, of the equipment that gives rise to the claim. Except as provided below, AT&T and its affiliates and suppliers shall not be liable for any incidental, special, reliance, consequential, or indirect loss or damage incurred in connection with the equipment. As used in this paragraph, consequential damages include, but are not limited to, the following: lost profits, lost revenues, and losses arising out of unauthorized use (or charges for such use) of common carrier telecommunications services or facilities accessed through or connected to the equipment. For personal injury caused by AT&T's negligence, AT&T's liability shall be limited to proven damages to person. **No action or proceeding against AT&T or its affiliates or suppliers may be commenced more than twenty-four (24) months after the cause of action accrues.** THIS PARAGRAPH SHALL SURVIVE FAILURE OF AN EXCLUSIVE REMEDY.

Remote Administration and Maintenance

The Remote Administration and Maintenance feature of your telecommunications system, if you choose to use it, permits users to change the system features and capabilities from a remote location.

The Remote Administration and Maintenance feature, through proper administration, can help you reduce the risk of unauthorized persons gaining access to the network. However, telephone numbers and access codes can be compromised when overheard in a public location, are lost through theft of a wallet or purse containing access information, or through carelessness (for example, writing codes on a piece of paper and improperly discarding them). Additionally, hackers may use a computer to dial an access code and then publish the information to other hackers. Substantial charges can accumulate quickly. It is your responsibility to take appropriate steps to implement the features properly, evaluate and administer the various restriction levels, and protect and carefully distribute access codes.

Under applicable tariffs, you will be responsible for payment of toll charges. AT&T cannot be responsible for such charges and will not make any allowance or give any credit resulting from unauthorized access.

To reduce the risk of unauthorized access through Remote Administration and Maintenance, please observe the following procedures:

- The System Administration and Maintenance capability of a Hybrid/PBX or Key system is protected by a password.
 - Change the default password immediately.
 - Continue to change the password regularly.
 - Only give the password to people who need it and impress upon them the need to keep it secret.
 - If anyone who knows the password leaves the company, change the password immediately.
- If you have a special telephone line connected to your Hybrid/PBX or Key system for Remote Administration and Maintenance, you should do one of the following:
 - Unplug the line when it is not being used.
 - Install a switch in the line to turn it off when it is not being used.
 - Keep the Remote Administration and Maintenance telephone number secret. Only give it to people who need to know it, and impress upon them the need to keep it a secret. Do not write the telephone number on the Hybrid/PBX or Key system, the connecting equipment, or anywhere else in the system room.

- If your Remote Administration and Maintenance feature requires that someone in your office transfer the caller to the Remote Administration and Maintenance extension, you should impress upon your employees the importance of only transferring authorized individuals to that extension.

System Forms

B

This appendix contains one copy of each system planning form. The forms are in numerical order and organized according to planning purpose as shown in Table B-1. You should make copies of these forms and use the copies, keeping the originals for future use. Planning forms for data communications are contained in Appendix C. The T1/PRI Planner is contained in Appendix D. The NI-1 BRI Planner is contained in Appendix G.

Table B-1. Forms

Used for Planning	Form No.	Form Title
Features and Calling Privileges	N/A	Employee Communication Survey
Control Unit Assembly and Operating Conditions	1	System Planning
System Component Numbering	2a	System Numbering: Extension Jacks
	2b	System Numbering: Digital Adjuncts
	2c	System Numbering: Line/Trunk Jacks
	2d	System Numbering: Special Renumbers

Continued next page

Table B-1, Continued

Used for Planning	Form No.	Form Title
Incoming Line/Trunk Connections	3a	Incoming Trunks: Remote Access
	3b	Incoming Trunks: DS1 Connectivity (100D Module)
	3c	Incoming Trunks: Tie
	3d	Incoming Trunks: DID
	3e	Automatic Route Selection Worksheet
	3f	Automatic Route Selection Tables
	3g	Automatic Route Selection Default and Special Numbers Tables
	3h	LS-ID Delay
	3i	Incoming Trunks: BRI Options
	4a	Extension Copy: Analog Multiline Telephone Template
	4b	Analog Multiline Telephone
	4c	Extension Copy: MLX Telephone Template
	4d	MLX Telephone
	4e	MFM Adjunct: MLX Telephone
4f	Tip/Ring Equipment	
Direct-Line Console (DLC): Analog	5a	Direct-Line Console (DLC): Analog
	5b	Direct-Line Console (DLC): Digital
	5c	MFM Adjunct: DLC
	5d	Queued Call Console (QCC)
Features for Operators	6a	Optional Operator Features
Features for User Groups	6b	Optional Extension Features
	6c	Principal User of Personal Line
Features for Systemwide Use	6d	Message-Waiting Receivers
	6e	Allowed Lists
	6f	Disallowed Lists
	6g	Call Restriction Assignments and Lists
	6h	Authorization Codes
	6i	Pool Dial-Out Code Restrictions
	7a	Call Pickup Groups
	7b	Group Paging
	7c	Group Coverage
	7d	Group Calling
8a	System Features	
Night Service: Group Assignment	9a	Night Service: Group Assignment
	9b	Night Service: Outward Restriction
	9c	Night Service: Time Set
10a	Label Form: Posted Message	
10b	System Speed Dial	

Data Forms

C

This appendix contains one copy of each data form. The forms are listed in Table C-1. You should make copies of these forms and use the copies, keeping the originals for future use.

Table C-1. Data Forms

Form No.	Form Title
1a	Modem Data Station
1b	ISDN Terminal Adapter Data Station
2	Data Hunt Groups
3	Digital Data/Video Station

T1/PRI Review

D

To ensure compatibility with the system, all local offerings of DS1 configurations must be reviewed by AT&T National Technical Marketing (NTM) personnel. This review begins when NTM receives the "T1/PRI Planner" form. This appendix contains instructions for completing the planner, including a blank form. You should make copies of the form pages and use the copies, keeping the originals for future use.

Form Needed

T1/PRI Planner

Planning Form Instructions

1. On page 1, fill in the customer name, telephone number, and address.

NOTE:

Reference Number is filled in by NTM.

2. Fill in the Order Number.
3. Identify the personnel handling the account:
 - a. Account Executive's name and telephone number.
 - b. System Consultant's name and telephone number.
4. Identify the DS1 facility vendor by writing the vendor's name under the T1/PRI Vendor heading, along with the contact person's name and telephone number.

5. Under the Installation heading:
 - a. Write the "Due Date" on which the installation is scheduled to be complete.
 - b. Write the date the equipment is scheduled for delivery to the customer in the Materials-on-Job Date space.
6. Under the Installation Contacts heading, list the names and telephone numbers of the personnel responsible for the equipment order and its installation:
 - a. (Order) Implementor
 - b. NTM Manager
 - c. National Technical Service Center (NTSC) Engineer
 - d. Data Services Organization (DSO) Manager
7. Under the question about whether the order has been placed:
 - If the order has been placed, check the Yes box and fill in the date.
 - If the order has not been placed, check the No box.
8. On page 2, complete one box for each 100D module by transferring the options information for each module from the corresponding box on Form 3b (page 1):
 - a. Service Ordered or Planned (Type of Service)
 - b. Frame Format
 - c. Line Coding (Suppression)
 - d. Line Signaling Mode
 - e. Synchronization Timing (Clock Synchronization: Source).
9. To ensure that the synchronization integrity of the network—both this communications system and its far-end connections—is protected, prepare the Network Planning Map on page 3 for review by NTM. Describe the entire network of DS1 facilities by summarizing the following for each 100D module:
 - a. Fill in the control unit slot number(s) of the 100D modules connected to the CSU(s).
 - b. Write the approximate number of cable feet between each module and its CSU or far-end connection (refer to the Line Compensation entry on Form 3b, Page 1).

- c. For the model number(s) of the CSU(s), do *one* of the following:
 - If the CSU is the ACCULINK 3150, check the box for the ACCULINK 3150.
 - If the CSU is not the ACCULINK 3150, check the Other box and write the manufacturer's name and model number in the space provided at the bottom of the page.
 - If no CSU is needed, check None.
 - d. In the connection block(s), describe the DS1's far-end connection by doing *one* of the following:
 - If connected to the telephone company central office, check CO.
 - If connected to another communications system, check PBX.
 - If connected to the PRI network, check PRI.
 - If the facility's type of service is T1, check the type(s) of emulated trunks. Also, check the Services box if the facility includes services such as MultiQuest with DNIS.
 - e. Describe the clock synchronization sources according to the key at the lower left of the map.
 - i. Draw a circle and line from the clock source to the appropriate 100D module.
 - ii. Label the circle **P** for primary, **S** for secondary, or **T** for tertiary.
10. Make a copy of the T1/PRI Planner for your records and forward the original to NTM.

As an example, the system described in Figure D–1 shows a processor module system with two 100D modules.

The communications system in Figure D–1 is configured as follows:

- Module 1 in slot 04 is connected to an ACCULINK 3150 CSU that is approximately 100 cable feet from the control unit. (The DS1 facility is connected to the PRI network.)
- Module 2 in slot 05 is connected to an ACCULINK 3150 CSU that is approximately 160 cable feet from the control unit. (The far end is another communications system.)
- The primary clock synchronization source is the PRI network connected to Module 1. Its path is shown by a line and the letter **P**.
- The secondary clock synchronization path, shown by a line and the letter **S**, is the system internal clock.

Network Planning Map

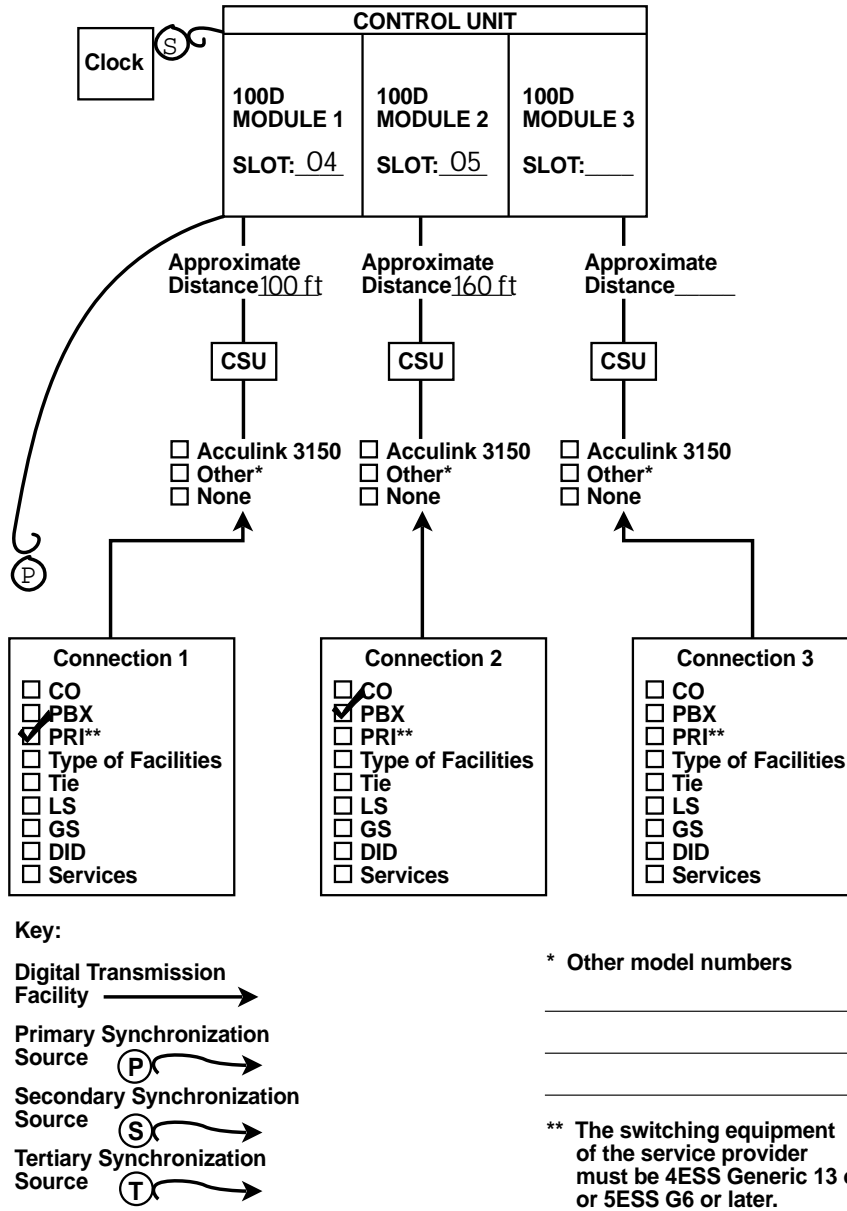

Figure D-1. Sample Network Planning Map

NTM also evaluates the complexity of the facility configuration requested. Examples of complex configurations are connections into PBX networking applications, connections to multiplexing arrangements, or applications that involve customer engineering or design. NTM then does one of the following:

- If an order is considered complex, NTM directs you to the Business Communications System (BCS) National Engineering Center (NEC).
- If NTM notifies you that the order's configuration is not complex, Tier III General Business System (GBS) National Technical Service Center (NTSC) is authorized to approve the configuration.

The NTSC group's preauthorization review is based, in part, on information you provide to them. Specifically, you must send them the following:

- A copy of the planner
- A completed "Non-Complex Configuration" sheet (pages 5 through 7 of the Planner) for each 100D module you plan to install

Complete one Non-Complex Configuration page (pages 5 through 7) for each 100D module. Label the top right corner of the copies "Page 1 of _" (1, 2, or 3). On each page:

1. Write the module number (1, 2, or 3). Indicate the total number of 100D modules (maximum of 3 for each system).
2. Fill in the control unit slot number (refer to page 1 of Form 3b).
3. In the Services section:
 - a. Check the box next to each emulated trunk or service that will be connected. Check only those services allowed on the type of service (T1 or PRI) selected for the module.
 - b. Circle the channel(s) to which each emulated trunk or service will be assigned.

NOTE:

No channel should show more than one trunk or service, and the 24th channel cannot be used if the signaling type is common channel.

4. If the type of service is PRI, complete the PRI Identification Service section by doing *one* of the following:
 - If you are not planning to use the number identification service, check the No box and proceed to Step 5.
 - If you are planning to use the identification services, check the Yes box and check the service planned:
 - For incoming calls, check one of the following boxes: ANI, SID, or Both. If both automatic and extension identification service are planned, indicate the order in which the information should be displayed (ANI then SID or SID then ANI).
 - For outgoing calls, check either ANI, SID/ANI Privacy, SID—Extension Based, or SID—Line Based to indicate the service planned.

NOTE:

The availability of the caller identification information may be limited by local-serving (caller's) jurisdiction, availability, or central office equipment.

5. In the Channel Service Unit section:
 - a. Check the box that describes the channel service unit used. If you are not using the model listed, check the second box and write in the manufacturer information that describes the unit.
 - b. Forward all copies of this page along with a copy of the Planner to Tier III, General Business Systems, National Technical Service Center.

DS1 Connectivity Ordering

E

After the contract is signed, the sales representative or authorized dealer contacts the DS1 connectivity vendor to discuss the T1/PRI service order. The vendor needs information about the communications system as well as customer identification. Table E-1 describes the kind of information the vendor requires. This table should be reviewed with the customer's network representative or dealer so the information will be available when needed.

Table E-1. Guide to DS1 Connectivity Ordering

Communications System

Manufacturer	AT&T
Model	MERLIN LEGEND
Type (Mode)	digital PBX
Jack Type	RJ48C or RJ48X
Facility Interface Code	Digital D4 Framing Digital ESF Framing Digital ESF and B8ZS

Digital PBX

- Has the EIA standard CISA transmission path
- Is senderized
- Is the equipment that must be timed
- Has an internal stratum clock level of 4
- Provides automatic call distribution through Group Calling feature
- Provides loopback (keep signal alive) through CSU.

Channel Service Unit

Manufacturer AT&T Other _____
Model 3150 _____
Reg. Number AW2USA-74673-DD-E _____

Facility Interface Codes: Digital D4 Framing
 Digital ESF Framing
 Digital ESF and B8ZS

Standard CSU jacks and test point provided

Audible Ringing Source

Digital PBX Channel Service

Testing Service

AT&T _____

If a CSU other than those listed above is used, AT&T will not accept the responsibility for its installation, connection, or testing.

Echo Control Device — not used

Unit Load Calculation

F

A unit load is a measure of power (1.9 watts) used to determine the electrical load that the following components have on *each carrier's* power supply:

- **Telephones and Adjuncts.** Only the telephones and adjuncts that connect to the analog and digital ports on the control unit require unit load calculation. Do not include any equipment with its own power supply in the unit load calculation.
- **Direct Inward Dial (DID) modules**

Unit load and power requirements for a new system are computed automatically when the equipment for the system is initially ordered. These calculations are based on the assumption that each module is fully utilized, that is, all jacks are used.

It may be useful to obtain more accurate calculations, for example, if the modules are not fully utilized, if there is a change in the equipment, or if you suspect that a particular carrier has more unit loads than the power supply can handle. You can calculate the actual unit load using the worksheet and instructions in this appendix.

Unit Load Rules

A general rule to follow is that if you can distribute the DID modules and telephone modules equally across the carriers, you will prevent unnecessary drain on any one carrier.

Also, depending on the system's mode, the rules vary. This section provides the rules for calculating unit loads in various modes.

Unit Loads for the Hybrid/PBX Mode

The 391A1 and 391A2 power supplies have a maximum rating of 54 unit loads and generally can support six modules of any type in a system in Hybrid/PBX mode—without exceeding the 54-unit maximum. If, however, both of the following conditions are true, the unit loads on a carrier can exceed the 54-unit maximum:

- All six carrier slots are occupied by MLX or analog multiline telephone modules
- The carrier has a total of more than 45 MLX-20L telephones or 34-button analog multiline telephones installed

The 391A3 power supply has a maximum rating of 75 unit loads. If your system contains a 391A1 or 391A2 power supply module, and the unit loads for that carrier will exceed 54, a 391A3 power supply should be installed in the system. Auxiliary Power Units cannot be used with the 391A3 power supply.

Unit Loads for Key or Behind Switch Mode

In a Key or Behind Switch system with four or fewer modules, no calculation is needed. The power supply generally supports four modules of any type in Key or Behind Switch mode.

Calculating Unit Loads

Use the worksheet and instructions in the remainder of this appendix to calculate unit loads for each carrier. Make a copy of all pages of the worksheet for each carrier.

Unit Load Worksheet

1. Number of modules in carrier (excluding power supply and processor): _____
 - If fewer than 5, no further calculation is required.
 - If 5 or 6, continue to Step 2.

2. Key or Behind Switch mode only: Key
Indicate configuration of lines; then go to Step 5. Modified

3. Hybrid/PBX mode only: Yes
Do all modules in the carrier have MLX and/or No
analog multiline telephone jacks?
 - If no, no further calculation is required.
 - If yes, continue to Step 4.

4. Hybrid/PBX mode only:
 Calculate the total number of MLX and analog multiline telephones.
 Number of MLX-20L telephones connected to modules in the carrier: _____
 Number of MLX-28D telephones connected to modules in the carrier: _____
 Number of 34-button analog multiline telephones connected to modules in the carrier: _____
 Total of MLX-20L, MLX-28D, and 34-button analog telephones _____
- If total is less than 45, no further calculation is required.
 - If total is 45 or more, continue to Step 5.

5. Calculate the estimated unit loads.

Module	Qty x	Unit Load	= Total
008		12.0	
008 MLX		13.25	
008 OPT		8.0	
012		8.4	
016		12.8	
100D		0.0	
400		0.0	
400 EM		8.0	
400 GS/LS/TTR		0.0	
408		12.0	
408 GS/LS		12.0	
408 GS/LS-MLX		13.5	
800		0.0	
800 GS/LS		0.0	
800 DID		8.0	
800 GS/LS-ID		8.0	
800 NI-BRI		0.0	

- Total Estimated Unit Load
- If total is less than 54 (for the 391A1 or 391A2 power supplies) or 75 (for the 391A3 power supply), no further calculation is required.
 - If total is 54 (391A1 or 391A2 power supplies) or 75 (391A3 power supply) or more, continue to Step 6.

6. Calculate the actual carrier unit load.
- If the total actual unit load is less than or equal to 54 (391A1 or 391A2 power supplies) or less than or equal to 75 (391A3 power supply), no further calculation is required.
 - If the total actual unit load is more than 54 (391A1 or 391A2 power supplies) or more than 75 (391A3 power supply), continue to Step 7.

Module	Qty x	Unit Load	= Total
Equipment		Hybrid/PBX or Modified	Key
Network Access Lines*			
DID		1.0	1.0
DS1		0.0	0.0
NI-1 BRI		0.0	0.0
GS/LS		0.0	0.0
Tie		1.4	1.4
Telephones			
MLX-10		0.9	1.2
MLX-10D		0.9	1.2
MLX-10DP		0.9	1.2
MLX-28D		1.2	1.7
MLX-20L		1.1	1.6
BIS-10		0.9	1.1
BIS-22		1.0	1.3
BIS-22D		1.0	1.3
BIS-34		1.1	1.5
BIS-34D		1.1	1.5
MLC-5		0.0	0.0
MDC 9000		0.0	0.0
MDW 9000		0.0	0.0
10-Button Basic		0.9	1.1
10-Button HFAI		1.0	1.2
34-Button Basic		0.9	1.1
34-Button DLX		1.2	1.7
34-Button BIS		1.2	1.4
34-Button BIS/DIS		1.2	1.4
Single-Line Telephone		0.6	0.7
Optional Equipment†			
Direct Station Selector‡		0.7	0.9
General-Purpose Adapter		0.8	1.0
Hands-Free Unit		0.8	1.0
Headset Adapter		0.8	1.0
		Total Actual Unit	

* Unit loads are computed for each trunk for trunk-type network access lines.

† The MFM has its own wall power unit located at the telephone and therefore is not added to the unit load calculation.

‡ Up to two DSSs (one DSS for each MLX-28D or MLX-20L) can be powered from each control unit carrier. For example, a three-carrier system can have six system operator positions, each with one DSS powered from the control unit.

7. Try to exchange modules between carriers to reduce the unit loads to 54 (if a 391A1 or 391A2 power supply is installed) or 75 (if a 391A3 power supply is installed). (Remember that the 100D, 800 NI-BRI, 400, 400 GS/LS, 800, and 800 GS/LS modules have unit loads of 0.0.) Repeat Steps 1 through 6 to recalculate unit loads for the new configuration.

NOTES:

Empty slots are not permitted between modules.

- If the exchange reduces the unit load to below the rated maximum for your power supply module, no further calculation is required.
- If the exchange does not reduce the unit load to 54, replace the 391A1 or 391A2 power supply with a 391A3 power supply. If your system has a 391A3 power supply and the exchange does not reduce the unit load to 75, continue to Step 8.

8. Calculate the unit load for slots 5 and 6 of the carrier.

- If the unit load for slots 5 and 6 is less than or equal to 27, power is sufficient for the carrier.
- If the unit load for slots 5 and 6 is more than 27, continue to Step 9.

Module	Qty x	Unit Load	= Total
		Hybrid/PBX or Modified	Key
Equipment			
Network Access Lines*			
DID		1.0	1.0
DS1		0.0	0.0
NI-1 BRI		0.0	0.0
GS/LS		0.0	0.0
Tie		1.4	1.4
Telephones			
MLX-10		0.9	1.2
MLX-10D		0.9	1.2
MLX-10DP		0.9	1.2
MLX-28D		1.2	1.7
MLX-20L		1.1	1.6
BIS-10		0.9	1.1
BIS-22		1.0	1.3
BIS-22D		1.0	1.3
BIS-34		1.1	1.5
BIS-34D		1.1	1.5
MLC-5		0.0	0.0

* Unit loads are computed for each trunk for trunk-type network access lines.

Continued on next page

Continued from previous page

Module	Qty x	Unit Load	= Total
Equipment		Hybrid/PBX or Modified	Key
MDC 9000		0.0	0.0
MDW 9000		0.0	0.0
10-Button Basic		0.9	1.1
Optional Equipment†			
10-Button HFAI		1.0	1.2
34-Button Basic		0.9	1.1
34-Button DLX		1.2	1.7
34-Button BIS		1.2	1.4
34-Button BIS/DIS		1.2	1.4
Single-Line Telephone		0.6	0.7
Direct Station Selector‡		0.7	0.9
General-Purpose Adapter		0.8	1.0
Hands-Free Unit		0.8	1.0
Headset Adapter		0.8	1.0
Total Actual Unit Load			

† The MFM has its own wall power unit located at the telephone and, therefore, is not added to the unit load calculation.

‡ Up to two DSSs (one DSS for each MLX-28D or MLX-20L) can be powered from each control unit carrier. For example, a three-carrier system can have six system operator positions, each with one DSS powered from the control unit.

9. Try to exchange modules between carriers to reduce the unit loads for slots 5 and 6 through 27. (Remember that the 100D, 800 NI-BRI, 400, 400 GS/LS, 800, and 800 GS/LS modules have unit loads of 0.0.) Repeat Steps 1 through 8 to recalculate unit loads for each new configuration.

NOTES:

Empty slots are not permitted between modules.

- If the unit load for slots 5 and 6 is less than or equal to 27, power is sufficient for the carrier.
- If the exchange does not reduce the unit load for slots 5 and 6 to 27, install wall power units for the appropriate number of telephones to reduce the unit load to 27.

NI-1 BRI Review



This appendix contains instructions for completing the NI-1 BRI Planner Form. If you have questions while completing the form prior to the sale, contact the AT&T National Technical Marketing (NTM) engineers. Once the contract has been signed and the forms are completed, make a photocopy of the forms for your records and forward the forms to the technician who will do the installation. The technician will then fax a copy to the National Service Assistance Center (NSAC) if any questions or problems occur at the customer site.

The NI-1 BRI Planner form should be used in conjunction with System Form 3i, Incoming Trunks: BRI Options (800 NI-BRI Module).

Form Needed

NI-1 BRI Planner

Planning Form Instructions

NOTE:

Prior to completing any of the steps below, you should first verify that the customer's local service provider offers National ISDN-1 BRI service with ISDN Ordering Code (IOC) standardized capability package "S" and a separate Multi-Line Hunt (MLH) service, depending on the customer's requirements. If the Central Office uses an AT&T 5ESS or Siemens SSC EWSD switch, MLH is available through the Series Completion feature. The Multi-Line Hunt Group (MLHG) feature on these CO switches is not recommended for use with MERLIN LEGEND. The Northern Telecom DMS-100 provides MLH service through the MLHG feature. A customer may want to order several BRI lines, some assigned as IOC package "S" and the others as MLH.

To properly order and administer NI-1 BRI service, it may be necessary to contact the local service provider to determine what services are available and the type of switching equipment used. See Appendix H, "NI-1 BRI Provisioning" for detailed information that the local service provider may require in order to supply the necessary connections.

1. On page 1, fill in the customer name, telephone number, and address.

NOTE:

Reference Number is filled in by NTM.

2. Fill in the Order Number.
3. Identify the personnel handling the account:
 - a. Account Executive's name and telephone number.
 - b. System Consultant's name and telephone number.
4. Identify the NI-1 BRI facility vendor by writing the vendor's name under the NI-1 BRI Vendor heading, along with the contact person's name and telephone number.
5. Under the Installation heading:
 - a. Write the "Due Date" on which the installation is scheduled to be complete.
 - b. Write the date the equipment is scheduled for delivery to the customer in the Materials-on-Job Date space.
6. Under the Installation Contacts heading, list the names and telephone numbers of the personnel responsible for the equipment order and its installation:
 - a. (Order) Implementor
 - b. NTM Manager
 - c. National Technical Service Center (NTSC) Engineer
 - d. Data Services Organization (DSO) Manager
7. Under the question about whether the order has been placed:
 - If the order has been placed, check the Yes box and fill in the expected service turn on date.
 - If the order has not been placed, check the No box.
8. On page 2, enter the type of BRI service to be ordered. Since MERLIN LEGEND Release 4.0 supports only National ISDN-1 BRI (2B+D) service, enter **NI-1 BRI** in the space provided under the Type of Service heading.

9. Contact the local service provider and determine what type of CO switch serves your area (such as, AT&T 5ESS, Northern Telecom DMS-100, or Siemens SSC EWSD). Enter this information under the Type of CO Switch heading on page 2 of the form.
10. Determine which type of configuration is best suited for your system. Some guidelines for selecting the service configuration are shown below:

- **IOC capability package “S”**

Each BRI line, also called a Digital Subscriber Line (DSL), consists of two B-channels, both of which support voice and data calls. In order to have two simultaneous voice or digital data calls, each DSL must be assigned two Directory Numbers (DNs) and two Service Profile Identifiers (SPIDs) by the CO. Basic call handling is supported along with the Calling Party Number/Billing Number (CPN/BN) identification feature. No packet data capabilities or hunting features are provided.

NOTE:

On the AT&T 5ESS switch, the Calling Party Number identification feature is assigned using the standard BRCS preconstructed features **/LICNDA** and **/CPCOFA**. If it is possible, request **/CPCPFA** for the Calling Number Identification feature from your local service provider as it provides a clearer display of the CPN information.

IOC package “S” supports a maximum of one call per telephone number (DN) at any given time. If another call comes in on that line, the caller gets a busy signal.

For Canada and those areas of the United States where IOC package “S” is not available, the capability package that is ordered must provide alternate voice/circuit-switched data on both B-channels with no packet data capability or supplementary voice features except for the CPN/BN feature if available. See Appendix H, “NI-1 BRI Provisioning” for detailed information.

- **Multi-Line Hunt (MLH)**

This feature is not part of the IOC package “S” and must be provisioned separately.

One or more BRI lines (and their associated DN) are grouped together with one (main) telephone number. When an incoming call arrives at the main number, the CO searches through the DN until an available line is found.

NOTE:

Each DN in the MLH group can be dialed directly, but hunting may not be initiated (depending on the CO switch).

For the Siemens SSD EWSD switch, each MLH group must be assigned as either voice or data; alternate voice/data is not supported as mixing the two types in one group could create call interference. This constraint does not apply to the AT&T 5ESS or the Northern Telecom DMS-100 switches.

The administration for Multi-Line Hunt is CO switch dependent. The AT&T 5ESS and Siemens SSC EWSD switches provide hunting through the Series Completion feature. The Northern Telecom DMS-100 switch provides hunting through the Multi-Line Hunt Group (MLHG) feature. Contact the local service provider to determine what type of switching equipment is in use and check the appropriate box under the MLH subheading of the Service Configurations section on page 2 of the form.

The MERLIN LEGEND has currently been tested with each switch type in the following configurations:

- AT&T 5ESS in a linear hunt group
- Northern Telecom DMS-100 in a circular hunt group
- Siemens SSC EWSD in a circular hunt group

Other configurations are possible, but are not guaranteed to work.

Appendix H, "NI-1 BRI Provisioning" provides sample LEC administration screens of the Series Completion and MLHG features. These screens show the fields and parameters for the CO switch and may be forwarded to the local service provider if necessary.

11. Once you have determined your Service Configuration, do *one* of the following:
 - If your Service Configuration will be IOC "S", check the box beside the IOC "S" selection under the Service Configuration heading, then enter the number of BRI lines that will be provisioned using this package.
 - If your Service Configuration will be MLH, check the box beside the MLH selection under the Service Configurations heading.
 - Indicate the type of MLH configuration by checking the box for MLHG (Northern Telecom DMS-100) or Series Completion (AT&T 5ESS or Siemens SSC EWSD).
 - Enter the total number of BRI lines provisioned using MLH, the number of BRI lines provisioned as voice only hunt groups, the number of BRI lines provisioned as data only hunt groups, and the number of BRI lines provisioned as voice/data hunt groups in the spaces provided.

NOTE:

MERLIN LEGEND Release 4.0 does not support voice/data hunt groups with the Siemens SSC EWSD CO switch.

12. Specify the total number of BRI lines under the Number of BRI Lines Ordered heading.
13. If CPN/BN is available with the BRI lines ordered, check the CPN/BN box under the Additional Features heading.
14. Make a copy of the NI-1 BRI Planner for your records and forward the original to the technician who will perform the installation.

NI-1 BRI Provisioning

H

This appendix provides detailed information concerning the features and translations that make up the ISDN Ordering Code (IOC) standardized capability package "S", as well as the Multi-Line Hunt (MLH) feature. The MLH feature is provisioned using either the Multi-Line Hunt Group or Series Completion feature, depending on the CO switch type.

Specific translations are provided for the following switches:

- AT&T 5ESS
- Northern Telecom DMS-100
- Siemens SSC EWSD

After determining that the local service provider offers National ISDN-1 service, the information contained in this appendix should be given to the local service provider if necessary.

NOTE:

The administrative screens shown in this appendix are representative samples only. The local service provider will need to enter applicable data (such as the telephone numbers) where necessary. Also note that the administration covered in this appendix *does not* take place on the MERLIN LEGEND Communications System. All administration is performed by the local service provider on the CO switch.

AT&T 5ESS Switch Translations

For the AT&T 5ESS switch, Capability Package "S" includes alternate voice/circuit-switched data on two B-channels. It also supports Calling Number Identification on data and voice connections. Please note that in order to have simultaneous calls on the two B-channels, two Directory Numbers (DNs) must be assigned with this package.

The AT&T 5ESS switch also allows alternate voice and data hunting on one DN using the Series Completion feature.

ISDN Capability Package "S"

The information listed below provides the DN translations that define Capability Package "S", and the screens and fields that must be programmed.

The information provided shows the translations for one Digital Subscriber Line (DSL) and two DNs. For multiple DSLs/DNs, duplicate these screens and enter the applicable DSL and DN values as needed.

ISDN Ordering Code: Capability S

VIEW 23.2

DN1 Translations

Fields that must be programmed on Screens 1, 2, 3 and 4:

1.	DSL TN	<C plus Telephone number>
9.	ASSOC	<U>
11.	OE	<enter OE and type>
14.	D ISCN	<enter value>
15.	DSERV	<SX>
16.	B1SERV	<DMD>
17.	B2SERV	<DMD>
18.	NT1 TYPE	<enter NT1 type>
20.	DSL CLS	<STD>
21.	RSTR MP	<N>
22.	MDPKT	<0>
23.	MTERM	<2>
42.	USPID	<enter value>
43.	MAXBCHL	<2>
44.	ACT USER	<Y>

Fields that must be populated on Screens 4, 5, and 6:

48.	CKT TN	<enter TN>
49.	CKT LCC	<enter LCC>
50.	CKT RAX	<enter RAX value>
55.	TERMTYP	<TYPEA>
56.	DISPLAY	<Y>
60.	CSV	<1>
61.	CSV CHL	<ANY>
63.	CSV LIMIT	<1>
69.	CSD	<2>
70.	CSD CHL	<ANY>
72.	CSD LIMIT	<2>
126.	CPN SCRN	<Y>
140.	PIC	<enter PIC>

The Calling Number Identification feature is assigned using the standard BRCS preconstructed features **/LICNDA** and **/CPCOFA**. If it is possible, request **/CPCPFA** for the Calling Number Identification feature as it provides a clearer display of the CPN information.

The Redirecting Number Delivery (RND) feature is assigned using the preconstructed RND feature, **/RND**. These features are assigned to the user in View 23.8, Field 109.

DN2 Translations (Note: DSL information was built with DN1)

Fields that must be populated on Screens 1, 2, 3 and 4:

- 1. DSL TN <C plus second *Telephone number*>
- 9. ASSOC <U>
- 11. OE <enter *OE and type*>
- 42. USPID <enter *value*>
- 43. MAXBCHL <2>
- 44. ACT USER <Y>

Fields that must be populated on Screens 4, 5, and 6:

- 48. CKT TN <enter *TN*>
- 49. CKT LCC <enter *LCC*>
- 50. CKT RAX <enter *RAX value*>
- 55. TERMTYP <TYPEA>
- 56. DISPLAY <Y>
- 60. CSV <1>
- 61. CSV CHL <ANY>
- 63. CSV LIMIT <1>
- 69. CSD <2>
- 70. CSD CHL <ANY>
- 72. CSD LIMIT <2>
- 126. CPN SCRN <Y>
- 140. PIC <enter *PIC*>

The Calling Number Identification feature is assigned using the standard BRCS preconstructed features **/LICNDA** and **/CPCOFA**. If it is possible, request **/CPCPFA** for the Calling Number Identification feature as it provides a clearer display of the CPN information.

The Redirecting Number Delivery (RND) feature is assigned using the preconstructed RND feature, **/RND**. These features are assigned to the user in View 23.8, Field 109.

Series Completion Feature Translations

The sample screens shown below illustrate the translations for alternate voice and data hunting on one main DSL and three DNs forming a linear series completion group. Voice hunting is provided using Series Completion (Field 87, **SERHLN**). Data hunting is provided with Call Forward Data Busy Line (**/CFDBLAC**).

The 5ESS limits the number of members of a series completion group to 16 DNs, and the number of lines forwarded using **/CFDBLAC** to the value specified on Screen 9, Field 176 (**SIMINTRA**). This value is currently set to 99 series completion groups, but can be changed.

```

5ESS SWITCH LABNSC1
SCREEN 1 OF 14
                                RECENT CHANGE 23.8
                                DSL/BRCS ASSIGNMENT

(*)1. DSL TN C 2228700          SERVICES AND FEATURES          SCREENS
(*)4. MLHG _____          -----
(*)5. TERM _____          BRCS FEATURE LIST              6
(*)6. DSL OE _ _____      BRCS FEATURE PARAMETERS       7 to 9
(*)9. ASSOC U _____          CKT                            4 & 5
                                DELFEAT LIST                    14
                                DPKT                            10
                                DSL INFO                          2
                                ODB                              11
                                PPB1                             12
                                PPB2                             13
                                USER INFO                        3
    
```

```

5ESS SWITCH LABNSC1
SCREEN 2 OF 14
                                RECENT CHANGE 23.8
                                DSL/BRCS ASSIGNMENT (DSL INFO)

>11. OE I 00101209           25. CUT DGTS 2228
14. D ISCN 007096           26. ACSR GRP _____
15. D SERV SX                27. DFLT SRV _____
16. B1 SERV DMD
17. B2 SERV DMD
18. NT1 TYPE AULC
19. PM GRP PMDEF
20. DSL CLS STD
21. RSTR MP N
22. ACSR INH Y
23. MDPKT 8
24. MTERM 2
    
```

SCREEN 3 OF 14

5ESS SWITCH LABNSC1
RECENT CHANGE 23.8
DSL/BRCS ASSIGNMENT (USER INFO)

>28. USPID 0122287000
29. MAXB CHL 1
30. ACT USRY
31. PPB1 USRN
32. PPB2 USRN
33. AGI _

SCREEN 4 OF 14

5ESS SWITCH LABNSC1
RECENT CHANGE 23.8
DSL/BRCS ASSIGNMENT (CKT)

		CIRCUIT VOICE (CSV)		CIRCUIT DATA (CSD)	
>34. CKT TN	2228700	46. CSV	1	55. CSD	1
35. CKT LCC	DSL	47. CSV CHL	ANY	56. CSD CHL	ANY
36. CKT RAX	1	48. CSV ACO		57. CSD ACO	
37. CKT MLHG		49. CSV LIMIT	1	58. CSD LIMIT	1
38. CKT TERM		50. CSV NBLIMIT		59. CSD NBLIMIT	
39. NEW TN		51. SP DNA		60. K56 DNA	
40. CONFIG GRP	NI17507B	52. SP DNA QTY		61. K56 DNA QTY	
41. TERMTYP	TYPEA	53. AU DNA		62. K64 DNA	
42. DISPLAY	Y	54. AU DNA QTY		63. K64 DNA QTY	
43. EKTS					
44. CA					
45. CA QTY					

SCREEN 5 OF 14

5ESS SWITCH LABNSC1
RECENT CHANGE 23.8
DSL/BRCS ASSIGNMENT (CKT)

>64. TKS	N	72. SAR QTY		82. BUSY MONITOR	N
65. TAUTO	N	73. SAR ORIG	N	83. ATT MLHG	
66. SHARED	N	74. SAR TERM	N	84. RBV TGN	
67. SAUTO	N	75. INCOMING	N	85. ERCO ASGN	N
68. PRIVACY	N	76. INTERCOM	N	86. ERCO ACT	N
69. ICP	N	77. ORIG CW	N	87. SERHLN	2228701
70. SUSO	N	78. PP	N	88. BCK LNK	N
71. SUST	N	79. CA PREF	I	89. ACD POS NUM	
		80. AUTO HOLD	N	90. CIDIAL	ALLOW
		81. ONE TOUCH	N	91. PIC	
				92. PTC	
				95. E911 PSAP	N

```

                    5ESS SWITCH LABNSC1
SCREEN 6 OF 14      RECENT CHANGE 23.8
                    DSL/BRCS ASSIGNMENT

>106. BFGN _____ 109. FEATURE LIST (FL)
                    A
ROW FEATURE A P C R   FEATURE A P C R   FEATURE A P C R   FEATURE A P C R
1 /LIDLXA Y _ N N 10 _____ 19 _____ 28 _____
2 /CPCPFA Y _ N N 11 _____ 20 _____ 29 _____
3 /CFDBLAC Y _ N N 12 _____ 21 _____ 30 _____
4 _____ 13 _____ 22 _____ 31 _____
5 _____ 14 _____ 23 _____ 32 _____
6 _____ 15 _____ 24 _____ 33 _____
7 _____ 16 _____ 25 _____ 34 _____
8 _____ 17 _____ 26 _____ 35 _____
9 _____ 18 _____ 27 _____ 36 _____
    
```

```

                    5ESS SWITCH LABNSC1
SCREEN 7 OF 14      RECENT CHANGE 23.8
                    DSL/BRCS ASSIGNMENT (HIGH RUNNER FEATURE PARAMETERS)

>134. TG:GRPID      0      146. ACSR GRPNM _____ 158. QALWD      _
135. MOH ALW        _      147. EDS:GRPNM _____ 159. PRIORITY Q _
136. IDP NAME       _____ 148. BCLID GRP _____ 160. ARSSI      _
137. DPAT CAT      0      149. PFA:VGRPNM _____ 161. DIALPLN   _
138. ICR SFG       0      150. PFA:DGRPNM _____ 162. ALWMDR    _
139. SC1NAME       _____ 151. ATH:VGRPNM _____ 163. ACSR PINREQ _
140. SC1S          _      152. ATH:DGRPNM _____ 164. DRING     _
141. SC2NAME       _____ 153. MDR:GRPNM _____ 165. DCW DRING _
142. SC2S          _      154. ACCT:GRPNM _____ 166. CWO DRING _
143. CPUO:SELQ1    0      155. ARS:VGRPNM _____ 167. MWY DRING _
144. CPUO:SELQ2    0      156. ARS:DGRPNM _____
145. CPUT:TPREDQ   0      157. FRL      _____
    
```

```

                    5ESS SWITCH LABNSC1
SCREEN 8 OF 14      RECENT CHANGE 23.8
                    DSL/BRCS ASSIGNMENT (HIGH RUNNER FEATURE PARAMETERS)

>172. MESSAGE SERVICE (MSS)      175. MW:DCNDN _____

ROW   FEATURE   GRPNM
 1   _____
 2   _____
 3   _____
 4   _____
    
```

```

                    5ESS SWITCH LABNSC1
                    RECENT CHANGE 23.8
SCREEN 9 OF 14      DSL/BRCS ASSIGNMENT (HIGH RUNNER FEATURE PARAMETERS)

>176. CALL FORWARDING FEATURE PARAMETERS (CF)

```

ROW	FEATURE	FWD TO DN	TIMEOUT	BSRING	SIMINTER	SIMINTRA
1	/CFDBLAC	2228701	0	N	1	99
2	_____	_____	0	-	0	0
3	_____	_____	0	-	0	0
4	_____	_____	0	-	0	0
5	_____	_____	0	-	0	0
6	_____	_____	0	-	0	0

```

                    5ESS SWITCH LABNSC1
                    RECENT CHANGE 23.8
SCREEN 10 OF 14   DSL/BRCS ASSIGNMENT (DPKT)

```

>183. DPKT TN	_____	192. IECP DNIC	_____	198. H PVC LCN	_____
184. LCC	_____	193. PB GRP	_____	199. L IN LCN	_____
185. RAX	-	194. NOTIF	NO	200. H IN LCN	_____
186. MLHG	_____	195. ICP	N	201. L 2W LCN	_____
187. TERM	_____	196. HUNT NOTIF	_____	202. H 2W LCN	_____
188. LNR HNT TN	_____	197. TCID	_____	203. L OUT LCN	_____
189. HUNT DEACT	-			204. H OUT LCN	_____
190. CHL SEL	N			205. BUSY LIMIT	_____
191. NEW TN	_____			206. PMDR GRP	_____
				207. PMDR ACT	_____
				208. DNA	_____
				209. DNA QTY	_____

```

                    5ESS SWITCH LABNSC1
                    RECENT CHANGE 23.8
SCREEN 11 OF 14  DSL/BRCS ASSIGNMENT (ODB)

```

>210. ODB TN	_____	222. RATE	_____	234. L IN LCN	_____
211. LCC	_____	223. N2	_____	235. H IN LCN	_____
212. RAX	0	224. T1	_____	236. L 2W LCN	_____
213. MLHG	_____	225. T3	_____	237. H 2W LCN	_____
214. TERM	_____	226. WNDZ	_____	238. L OUT LCN	_____
215. LNR HNT TN	_____	227. NEW TN	_____	239. H OUT LCN	_____
216. HUNT DEACT	-	228. IECP DNIC	_____	240. BUSY LIMIT	_____
217. CHL SEL	N	229. PB GRP	_____	241. PMDR GRP	_____
218. ISCN1	_____	230. NOTIF	_____	242. PMDR ACT	_____
219. ISCN2	_____	231. T3XX	0	243. DNA	_____
220. BAND	0	232. ICP	N	244. DNA QTY	_____
221. ODB	-	233. HUNT NOTIF	_____		

```

                    5ESS SWITCH LABNSC1
                    RECENT CHANGE 23.8
                    DSL/BRCS ASSIGNMENT (PPB1)

SCREEN 12 OF 14

>245. PPB1 TN      _____  254. RATE           _____  264. H PVC LCN    ____
246. LCC          _____  255. N2            _____  265. L IN LCN    ____
247. RAX          0          _____  256. T1            _____  266. H IN LCN    ____
248. MLHG         _____  257. T3            _____  267. L 2W LCN    ____
249. TERM         _____  258. WNDZ         _____  268. H 2W LCN    ____
250. LNR HNT TN  _____  259. NEW TN       _____  269. L OUT LCN   ____
251. HUNT DEACT  _          _____  260. IECP DNIC    _____  270. H OUT LCN   ____
252. CHL SEL     N          _____  261. PB GRP       _____  271. BUSY LIMIT  ____
253. ISCN        _____  262. ICP          N          _____  272. PMDR GRP    _____
                    _____  263. HUNT NOTIF  _____  273. PMDR ACT    _
    
```

```

                    5ESS SWITCH LABNSC1
                    RECENT CHANGE 23.8
                    DSL/BRCS ASSIGNMENT (PPB2)

SCREEN 13 OF 14

>274. PPB2 TN      _____  283. RATE           _____  293. H PVC LCN    ____
275. LCC          _____  284. N2            _____  294. L IN LCN    ____
276. RAX          0          _____  285. T1            _____  295. H IN LCN    ____
277. MLHG         _____  286. T3            _____  296. L 2W LCN    ____
278. TERM         _____  287. WNDZ         _____  297. H 2W LCN    ____
279. LNR HNT TN  _____  288. NEW TN       _____  298. L OUT LCN   ____
280. HUNT DEACT  _          _____  289. IECP DNIC    _____  299. H OUT LCN   ____
281. CHL SEL     N          _____  290. PB GRP       _____  300. BUSY LIMIT  ____
282. ISCN        _____  291. ICP          N          _____  301. PMDR GRP    _____
                    _____  292. HUNT NOTIF  _____  302. PMDR ACT    _
    
```

```

                    5ESS SWITCH LABNSC1
                    RECENT CHANGE 23.8
                    DSL/BRCS ASSIGNMENT

SCREEN 14 OF 14

WARNING: These fields delete features currently on the view or in a BFG.
         Deletion of a feature in BFG may invoke BFG reselection.
    
```

```

303. DELFEAT

ROW  FEATURE
  1  _____
  2  _____
  3  _____
    
```

No Messages

5ESS SWITCH LABNSC1
 SCREEN 1 OF 14

RECENT CHANGE 23.8
 DSL/BRCS ASSIGNMENT

(*)	SERVICES AND FEATURES	SCREENS
1. DSL TN C 2228701		
4. MLHG	-----	-----
5. TERM	BRCS FEATURE LIST	6
6. DSL OE	BRCS FEATURE PARAMETERS	7 to 9
9. ASSOC U	CKT	4 & 5
	DELFEAT LIST	14
	DPKT	10
	DSL INFO	2
	ODB	11
	PPB1	12
	PPB2	13
	USER INFO	3

5ESS SWITCH LABNSC1
 SCREEN 2 OF 14

RECENT CHANGE 23.8
 DSL/BRCS ASSIGNMENT (DSL INFO)

>11. OE	I 00101209	25. CUT DGTS	2228
14. D ISCN	007096	26. ACSR GRP	_____
15. D SERV	SX	27. DFLT SRV	_____
16. B1 SERV	DMD		
17. B2 SERV	DMD		
18. NT1 TYPE	AULC		
19. PM GRP	PMDEF		
20. DSL CLS	STD		
21. RSTR MP	N		
22. ACSR INH	Y		
23. MDPKT	8		
24. MTERM	2		

SCREEN 3 OF 14

5ESS SWITCH LABNSC1
 RECENT CHANGE 23.8
 DSL/BRCS ASSIGNMENT (USER INFO)

>28. USPID 0122287010
 29. MAXB CHL 1
 30. ACT USER Y
 31. PPB1 USRN
 32. PPB2 USRN
 33. AGI _

5ESS SWITCH LABNSC1
RECENT CHANGE 23.8
DSL/BRCS ASSIGNMENT (CKT)

SCREEN 4 OF 14

```

>34. CKT TN      2228701      CIRCUIT VOICE (CSV)      CIRCUIT DATA (CSD)
35. CKT LCC    DSL          46. CSV                1                55. CSD                1
36. CKT RAX    1            47. CSV CHL            ANY            56. CSD CHL            ANY
37. CKT MLHG    _____    48. CSV ACO            _____    57. CSD ACO            _____
38. CKT TERM    _____    49. CSV LIMIT          1                58. CSD LIMIT          1
39. NEW TN      _____    50. CSV NBLIMIT        _____    59. CSD NBLIMIT        _____
40. CONFIG GRP NI17507A    51. SP DNA              _____    60. K56 DNA              _____
41. TERMTYP    TYPEA          52. SP DNA QTY          _____    61. K56 DNA QTY          _____
42. DISPLAY    Y              53. AU DNA              _____    62. K64 DNA              _____
43. EKTS       _____    54. AU DNA QTY          _____    63. K64 DNA QTY          _____
44. CA         _____
45. CA QTY     _____
    
```

5ESS SWITCH LABNSC1
RECENT CHANGE 23.8
DSL/BRCS ASSIGNMENT (CKT)

SCREEN 5 OF 14

```

>64. TKS      N      72. SAR QTY      _____    82. BUSY MONITOR N
65. TAUTO     N      73. SAR ORIG    N      83. ATT MLHG      _____
66. SHARED    N      74. SAR TERM    N      84. RBV TGN       _____
67. SAUTO     N      75. INCOMING   N      85. ERCO ASGN     N
68. PRIVACY   N      76. INTERCOM   N      86. ERCO ACT       N
69. ICP       N      77. ORIG CW     N      87. SERHLN        2228703
70. SUSO      N      78. PP          N      88. BCK LNK        Y
71. SUST      N      79. CA PREF     I      89. ACD POS NUM    _____
                        80. AUTO HOLD   N      90. CIDIAL         ALLOW
                        81. ONE TOUCH  N      91. PIC            _____
                        92. PTC          _____
                        95. E911 PSAP   N
    
```

5ESS SWITCH LABNSC1
RECENT CHANGE 23.8
DSL/BRCS ASSIGNMENT

SCREEN 6 OF 14

```

>106. BFGN    _____    109. FEATURE LIST (FL)
      A                A                A                A
ROW FEATURE A P C R  FEATURE A P C R  FEATURE A P C R  FEATURE A P C R
1 /CPCPFA  Y _ N N 10 _____ - - - - 19 _____ - - - - 28 _____ - - - -
2 /LIDLXA  Y _ N N 11 _____ - - - - 20 _____ - - - - 29 _____ - - - -
3 /CFDBLAC Y _ N N 12 _____ - - - - 21 _____ - - - - 30 _____ - - - -
4 _____ - - - - 13 _____ - - - - 22 _____ - - - - 31 _____ - - - -
5 _____ - - - - 14 _____ - - - - 23 _____ - - - - 32 _____ - - - -
6 _____ - - - - 15 _____ - - - - 24 _____ - - - - 33 _____ - - - -
7 _____ - - - - 16 _____ - - - - 25 _____ - - - - 34 _____ - - - -
8 _____ - - - - 17 _____ - - - - 26 _____ - - - - 35 _____ - - - -
9 _____ - - - - 18 _____ - - - - 27 _____ - - - - 36 _____ - - - -
    
```

```

                    5ESS SWITCH LABNSC1
                    RECENT CHANGE 23.8
SCREEN 7 OF 14      DSL/BRCS ASSIGNMENT (HIGH RUNNER FEATURE PARAMETERS)

>134. TG:GRPID      0          146. ACSR GRPNM _____ 158. QALWD          _
135. MOH ALW       _          147. EDS:GRPNM _____ 159. PRIORITY Q   _
136. IDP NAME      _____ 148. BCLID GRP _____ 160. ARSSI        _
137. DPAT CAT      0          149. PFA:VGRPNM _____ 161. DIALPLN     _
138. ICR SFG       0          150. PFA:DGRPNM _____ 162. ALWMDR      _
139. SC1NAME       _____ 151. ATH:VGRPNM _____ 163. ACSR PINREQ _
140. SC1S          _          152. ATH:DGRPNM _____ 164. DRING        _
141. SC2NAME       _____ 153. MDR:GRPNM _____ 165. DCW DRING   _
142. SC2S          _          154. ACCT:GRPNM _____ 166. CWO DRING   _
143. CPUO:SELQ1    0          155. ARS:VGRPNM _____ 167. MWY DRING   _
144. CPUO:SELQ2    0          156. ARS:DGRPNM _____
145. CPUT:TPREDQ   0          157. FRL          _____
    
```

```

                    5ESS SWITCH LABNSC1
                    RECENT CHANGE 23.8
SCREEN 8 OF 14      DSL/BRCS ASSIGNMENT (HIGH RUNNER FEATURE PARAMETERS)

>172. MESSAGE SERVICE (MSS)      175. MW:DCNDN _____

ROW   FEATURE   GRPNM
 1   _____
 2   _____
 3   _____
 4   _____
    
```

```

                    5ESS SWITCH LABNSC1
                    RECENT CHANGE 23.8
SCREEN 9 OF 14      DSL/BRCS ASSIGNMENT (HIGH RUNNER FEATURE PARAMETERS)

>176. CALL FORWARDING FEATURE PARAMETERS (CF)

ROW   FEATURE   FWD TO DN   TIMEOUT BSRING   SIMINTER   SIMINTRA
 1   /CFDBLAC   2228703     0         N           1           99
 2   _____   _____   0         -           0           0
 3   _____   _____   0         -           0           0
 4   _____   _____   0         -           0           0
 5   _____   _____   0         -           0           0
 6   _____   _____   0         -           0           0
    
```

5ESS SWITCH LABNSC1
SCREEN 1 OF 14

RECENT CHANGE 23.8
DSL/BRCS ASSIGNMENT

(*)1. DSL TN C 2228703	SERVICES AND FEATURES	SCREENS
(*)4. MLHG _____	-----	-----
(*)5. TERM _____	BRCS FEATURE LIST	6
(*)6. DSL OE _____	BRCS FEATURE PARAMETERS	7 to 9
(*)9. ASSOC U _____	CKT	4 & 5
	DELFEAT LIST	14
	DPKT	10
	DSL INFO	2
	ODB	11
	PPB1	12
	PPB2	13
	USER INFO	3

5ESS SWITCH LABNSC1
SCREEN 2 OF 14

RECENT CHANGE 23.8
DSL/BRCS ASSIGNMENT (DSL INFO)

>11. OE I 00101221	25. CUT DGTS 2228
14. D ISCN 007105	26. ACSR GRP _____
15. D SERV SX	27. DFLT SRV _____
16. B1 SERV DMD	
17. B2 SERV DMD	
18. NT1 TYPE TLC	
19. PM GRP _____	
20. DSL CLS STD	
21. RSTR MP N	
22. ACSR INH Y	
23. MDPKT 8	
24. MTERM 2	

SCREEN 3 OF 14

5ESS SWITCH LABNSC1
RECENT CHANGE 23.8
DSL/BRCS ASSIGNMENT (USER INFO)

>28. USPID 0122287030
29. MAXB CHL 1
30. ACT USER Y
31. PPB1 USRN
32. PPB2 USRN
33. AGI _____

```

                    5ESS SWITCH LABNSC1
                    RECENT CHANGE 23.8
SCREEN 4 OF 14          DSL/BRCS ASSIGNMENT (CKT)

>34. CKT TN      2228703      CIRCUIT VOICE (CSV)      CIRCUIT DATA (CSD)
35. CKT LCC     DSL          46. CSV                1                55. CSD                1
36. CKT RAX     1            47. CSV CHL            ANY            56. CSD CHL            ANY
37. CKT MLHG     _____  48. CSV ACO            _____  57. CSD ACO            _____
38. CKT TERM     _____  49. CSV LIMIT          1                58. CSD LIMIT          1
39. NEW TN       _____  50. CSV NBLIMIT        _____  59. CSD NBLIMIT        _____
40. CONFIG GRP  _____  51. SP DNA              _____  60. K56 DNA              _____
41. TERMTYP     TYPEA          52. SP DNA QTY         _____  61. K56 DNA QTY         _____
42. DISPLAY     Y            53. AU DNA              _____  62. K64 DNA              _____
43. EKTS        _____  54. AU DNA QTY         _____  63. K64 DNA QTY         _____
44. CA          _____
45. CA QTY      _____
    
```

```

                    5ESS SWITCH LABNSC1
                    RECENT CHANGE 23.8
SCREEN 5 OF 14          DSL/BRCS ASSIGNMENT (CKT)

>64. TKS        N      72. SAR QTY          _____  82. BUSY MONITOR N
65. TAUTO       N      73. SAR ORIG         N      83. ATT MLHG          _____
66. SHARED      N      74. SAR TERM         N      84. RBV TGN           _____
67. SAUTO       N      75. INCOMING         N      85. ERCO ASGN         N
68. PRIVACY     N      76. INTERCOM         N      86. ERCO ACT          N
69. ICP         N      77. ORIG CW          N      87. SERHLN            2228704
70. SUSO        N      78. PP                N      88. BCK LNK           Y
71. SUST        N      79. CA PREF          I      89. ACD POS NUM       _____
                        80. AUTO HOLD         N      90. CIDIAL            ALLOW
                        81. ONE TOUCH         N      91. PIC                _____
                        92. PTC                _____
                        95. E911 PSAP         N
    
```

```

                    5ESS SWITCH LABNSC1
                    RECENT CHANGE 23.8
SCREEN 6 OF 14          DSL/BRCS ASSIGNMENT

>106. BFGN      _____  109. FEATURE LIST (FL)
                        A          A          A          A
ROW FEATURE A P C R  FEATURE A P C R  FEATURE A P C R  FEATURE A P C R
1 /LIDLXA Y _ N N 10 _____ - - - - 19 _____ - - - - 28 _____ - - - -
2 /CPCPFA Y _ N N 11 _____ - - - - 20 _____ - - - - 29 _____ - - - -
3 /CFDBLAC Y _ N N 12 _____ - - - - 21 _____ - - - - 30 _____ - - - -
4 _____ - - - - 13 _____ - - - - 22 _____ - - - - 31 _____ - - - -
5 _____ - - - - 14 _____ - - - - 23 _____ - - - - 32 _____ - - - -
6 _____ - - - - 15 _____ - - - - 24 _____ - - - - 33 _____ - - - -
7 _____ - - - - 16 _____ - - - - 25 _____ - - - - 34 _____ - - - -
8 _____ - - - - 17 _____ - - - - 26 _____ - - - - 35 _____ - - - -
9 _____ - - - - 18 _____ - - - - 27 _____ - - - - 36 _____ - - - -
    
```

```

                    5ESS SWITCH LABNSC1
                    RECENT CHANGE 23.8
SCREEN 7 OF 14      DSL/BRCS ASSIGNMENT (HIGH RUNNER FEATURE PARAMETERS)

>134. TG:GRPID      0          146. ACSR GRPNM _____ 158. QALWD          -
135. MOH ALW       -          147. EDS:GRPNM _____ 159. PRIORITY Q   -
136. IDP NAME      _____ 148. BCLID GRP _____ 160. ARSSI        -
137. DPAT CAT      0          149. PFA:VGRPNM _____ 161. DIALPLN     -
138. ICR SFG       0          150. PFA:DGRPNM _____ 162. ALWMDR      -
139. SC1NAME       _____ 151. ATH:VGRPNM _____ 163. ACSR PINREQ -
140. SC1S          -          152. ATH:DGRPNM _____ 164. DRING        -
141. SC2NAME       _____ 153. MDR:GRPNM _____ 165. DCW DRING   -
142. SC2S          -          154. ACCT:GRPNM _____ 166. CWO DRING   -
143. CPUO:SELQ1    0          155. ARS:VGRPNM _____ 167. MWY DRING   -
144. CPUO:SELQ2    0          156. ARS:DGRPNM _____
145. CPUT:TPREDQ   0          157. FRL          _____
    
```

```

                    5ESS SWITCH LABNSC1
                    RECENT CHANGE 23.8
SCREEN 8 OF 14      DSL/BRCS ASSIGNMENT (HIGH RUNNER FEATURE PARAMETERS)

>172. MESSAGE SERVICE (MSS)      175. MW:DCNDN _____

ROW   FEATURE   GRPNM
 1   _____
 2   _____
 3   _____
 4   _____
    
```

```

                    5ESS SWITCH LABNSC1
                    RECENT CHANGE 23.8
SCREEN 9 OF 14      DSL/BRCS ASSIGNMENT (HIGH RUNNER FEATURE PARAMETERS)

>176. CALL FORWARDING FEATURE PARAMETERS (CF)

ROW   FEATURE   FWD TO DN   TIMEOUT BSRING   SIMINTER   SIMINTRA
 1   /CFDBLAC   2228704     0         Y           1           99
 2   _____   _____   0         -           0           0
 3   _____   _____   0         -           0           0
 4   _____   _____   0         -           0           0
 5   _____   _____   0         -           0           0
 6   _____   _____   0         -           0           0
    
```

5ESS SWITCH LABNSC1
SCREEN 1 OF 14

RECENT CHANGE 23.8
DSL/BRCS ASSIGNMENT

(*)	SERVICES AND FEATURES	SCREENS

1. DSL TN C 2228704		
4. MLHG _____		
5. TERM _____	BRCS FEATURE LIST	6
6. DSL OE _____	BRCS FEATURE PARAMETERS	7 to 9
9. ASSOC U _____	CKT	4 & 5
	DELFEAT LIST	14
	DPKT	10
	DSL INFO	2
	ODB	11
	PPB1	12
	PPB2	13
	USER INFO	3

5ESS SWITCH LABNSC1
SCREEN 2 OF 14

RECENT CHANGE 23.8
DSL/BRCS ASSIGNMENT (DSL INFO)

>11. OE	I 00101221	25. CUT DGTS	2228
14. D ISCN	007105	26. ACSR GRP	_____
15. D SERV	SX	27. DFLT SRV	_____
16. B1 SERV	DMD		
17. B2 SERV	DMD		
18. NT1 TYPE	TLC		
19. PM GRP	_____		
20. DSL CLS	STD		
21. RSTR MP	N		
22. ACSR INH	Y		
23. MDPKT	8		
24. MTERM	2		

SCREEN 3 OF 14

5ESS SWITCH LABNSC1
RECENT CHANGE 23.8
DSL/BRCS ASSIGNMENT (USER INFO)

>28. USPID	0122287040
29. MAXB CHL	1
30. ACT USERY	
31. PPB1 USRN	
32. PPB2 USRN	
33. AGI	_____

```

                    5ESS SWITCH LABNSC1
                    RECENT CHANGE 23.8
SCREEN 4 OF 14          DSL/BRCS ASSIGNMENT (CKT)

>34. CKT TN      2228704      CIRCUIT VOICE (CSV)      CIRCUIT DATA (CSD)
35. CKT LCC     DSL          46. CSV                1                55. CSD                1
36. CKT RAX     1            47. CSV CHL            ANY            56. CSD CHL            ANY
37. CKT MLHG     _____  48. CSV ACO            _____  57. CSD ACO            _____
38. CKT TERM     _____  49. CSV LIMIT          1                58. CSD LIMIT          1
39. NEW TN       _____  50. CSV NBLIMIT        _____  59. CSD NBLIMIT        _____
40. CONFIG GRP  _____  51. SP DNA              _____  60. K56 DNA              _____
41. TERMTYP     TYPEA        52. SP DNA QTY         _____  61. K56 DNA QTY         _____
42. DISPLAY     Y            53. AU DNA              _____  62. K64 DNA              _____
43. EKTS        _____  54. AU DNA QTY         _____  63. K64 DNA QTY         _____
44. CA          _____
45. CA QTY      _____
    
```

```

                    5ESS SWITCH LABNSC1
                    RECENT CHANGE 23.8
SCREEN 5 OF 14          DSL/BRCS ASSIGNMENT (CKT)

>64. TKS        N      72. SAR QTY          _____  82. BUSY MONITOR N
65. TAUTO       N      73. SAR ORIG        N      83. ATT MLHG          _____
66. SHARED      N      74. SAR TERM        N      84. RBV TGN           _____
67. SAUTO       N      75. INCOMING        N      85. ERCO ASGN         N
68. PRIVACY     N      76. INTERCOM        N      86. ERCO ACT          N
69. ICP         N      77. ORIG CW         N      87. SERHLN            _____
70. SUSO        N      78. PP              N      88. BCK LNK           Y
71. SUST        N      79. CA PREF         I      89. ACD POS NUM        _____
                        80. AUTO HOLD       N      90. CIDIAL             ALLOW
                        81. ONE TOUCH       N      91. PIC                _____
                        92. PTC                _____
                        95. E911 PSAP         N
    
```

```

                    5ESS SWITCH LABNSC1
                    RECENT CHANGE 23.8
SCREEN 6 OF 14          DSL/BRCS ASSIGNMENT

>106. BFGN      _____  109. FEATURE LIST (FL)
                        A          A          A          A
ROW FEATURE A P C R  FEATURE A P C R  FEATURE A P C R  FEATURE A P C R
1 /CPCPFA Y _ N N 10 _____ - - - - 19 _____ - - - - 28 _____ - - - -
2 /LIDLXA Y _ N N 11 _____ - - - - 20 _____ - - - - 29 _____ - - - -
3 _____ - - - - 12 _____ - - - - 21 _____ - - - - 30 _____ - - - -
4 _____ - - - - 13 _____ - - - - 22 _____ - - - - 31 _____ - - - -
5 _____ - - - - 14 _____ - - - - 23 _____ - - - - 32 _____ - - - -
6 _____ - - - - 15 _____ - - - - 24 _____ - - - - 33 _____ - - - -
7 _____ - - - - 16 _____ - - - - 25 _____ - - - - 34 _____ - - - -
8 _____ - - - - 17 _____ - - - - 26 _____ - - - - 35 _____ - - - -
9 _____ - - - - 18 _____ - - - - 27 _____ - - - - 36 _____ - - - -
    
```

```

                    5ESS SWITCH LABNSC1
                    RECENT CHANGE 23.8
SCREEN 7 OF 14      DSL/BRCS ASSIGNMENT (HIGH RUNNER FEATURE PARAMETERS)

>134. TG:GRPID      0          146. ACSR GRPNM _____ 158. QALWD          -
135. MOH ALW        -          147. EDS:GRPNM _____ 159. PRIORITY Q    -
136. IDP NAME       _____ 148. BCLID GRP _____ 160. ARSSI         -
137. DPAT CAT       0          149. PFA:VGRPNM _____ 161. DIALPLN       -
138. ICR SFG        0          150. PFA:DGRPNM _____ 162. ALWMDR        -
139. SC1NAME        _____ 151. ATH:VGRPNM _____ 163. ACSR PINREQ  -
140. SC1S           -          152. ATH:DGRPNM _____ 164. DRING         -
141. SC2NAME        _____ 153. MDR:GRPNM _____ 165. DCW DRING    -
142. SC2S           -          154. ACCT:GRPNM _____ 166. CWO DRING    -
143. CPUO:SELQ1     0          155. ARS:VGRPNM _____ 167. MWY DRING    -
144. CPUO:SELQ2     0          156. ARS:DGRPNM _____
145. CPUT:TPREDQ    0          157. FRL           _____
    
```

```

                    5ESS SWITCH LABNSC1
                    RECENT CHANGE 23.8
SCREEN 8 OF 14      DSL/BRCS ASSIGNMENT (HIGH RUNNER FEATURE PARAMETERS)

>172. MESSAGE SERVICE (MSS)      175. MW:DCNDN _____

ROW   FEATURE   GRPNM
 1   _____
 2   _____
 3   _____
 4   _____
    
```

```

                    5ESS SWITCH LABNSC1
                    RECENT CHANGE 23.8
SCREEN 9 OF 14      DSL/BRCS ASSIGNMENT (HIGH RUNNER FEATURE PARAMETERS)

>176. CALL FORWARDING FEATURE PARAMETERS (CF)

ROW   FEATURE           FWD TO DN   TIMEOUT BSRING   SIMINTER   SIMINTRA
 1   _____         _____   0           -           0           0
 2   _____         _____   0           -           0           0
 3   _____         _____   0           -           0           0
 4   _____         _____   0           -           0           0
 5   _____         _____   0           -           0           0
 6   _____         _____   0           -           0           0
    
```

Northern Telecom DMS-100 Switch Translations

For the Northern Telecom DMS-100 switch, Capability Package "S" includes alternate voice/circuit-switched data on two B-channels. It also supports Calling Number Identification on data and voice connections. Please note that the assignment of two DNs is required for this package.

The DMS-100 switch also allows alternate voice and data hunting on one DN through the Multi-Line Hunt Group feature.

ISDN Capability Package "S"

The information listed below provides the DN translations that define Capability Package "S", and the commands that must be executed.

ISDN Ordering Code: Capability S

Provision DN1 using the following translations

Define a new Logical Terminal Identifier (LTID) using the SLT command:

```
SONUMBER      <<cr> or $>
LTID          <enter identifier value>
FUNCTION      <ADD>
LTCLASS      <BRAFS>
CS           <Y>
PS           <N>
MAXKEYS     <64>
TEI_TYPE     <DTEI>
ABS         <NOPMD>
ABS         <$>
EKTS        <N>
SPIDSFX option
  SPID_SUFFIX <enter spid suffix value>
PVC option
  VERSION    <FUNCTIONAL>
  ISSUE      <2>
```

Associate new DN with LTID using the NEW command:

```

SONUMBER    <<cr> or $>
DN          <enter DN>
LCC         <ISDNKSET>
GROUP       <enter group name>
SUBGRP      <enter subgrp value>
NCOS        <enter ncos value>
SNPA        <enter NXX value>
KEY         <1>
RINGING     <Y>
LATANAME    <enter value>
LTG         <enter value>
LEN_OR_LTID <enter assigned value>
    
```

DMS100 normally delivers the Calling Party Number and the Redirecting Number, if available.

Attach LTIDs to LEN using the SLT command:

```

SONUMBER    <<cr> or $>
LTID        <enter value>
FUNCTION     <ATT>
LEN         <enter LEN to which LTID will be attached>
    
```

Provision DN2 using the following translations

Define a new Logical Terminal Identifier (LTID) using the SLT command:

```

SONUMBER    <<cr> or $>
LTID        <enter identifier value>
FUNCTION     <ADD>
LTCLASS     <BRAFS>
CS          <Y>
PS          <N>
MAXKEYS     <64>
TEI_TYPE    <DTEI>
ABS         <NOPMD>
    
```

ABS <\$>
 EKTS <N>
 SPIDSFX option
 SPID_SUFFIX <enter spid suffix value>
 PVC option
 VERSION <FUNCTIONAL>
 ISSUE <2>

Associate new DN with LTID using the NEW command:

SONUMBER <<cr> or \$>
 DN <enter DN>
 LCC <ISDNKSET>
 GROUP <enter group name>
 SUBGRP <enter subgrp value>
 NCOS <enter ncos value>
 SNPA <enter NXX value>
 KEY <1>
 RINGING <Y>
 LATANAME <enter value>
 LTG <enter value>
 LEN_OR_LTID <enter assigned value>

DMS100 normally delivers the Calling Party Number and the Redirecting Number, if available.

Attach LTIDs to LEN using the SLT command:

SONUMBER <<cr> or \$>
 LTID <enter value>
 FUNCTION <ATT>
 LEN <enter LEN to which LTID will be attached>

Multi-Line Hunt Group Feature Translations

The sample screens shown below illustrate the translations for alternate voice and data hunting on three Digital Subscriber Lines (DSLs) and six Directory Numbers (DNs) forming a circular hunt group. This hunting is provided using the Multi-Line Hunt Group feature.

The screens shown in this section are examples, DNs shown on these screens should be replaced with applicable data.

QDN 2257141

```

DN:      2257141
TYPE:    PILOT OF DNH HUNT GROUP
SNPA:    201  SIG:  N/A      LNATTIDX: N/A
HUNT GROUP:  22      HUNT MEMBER:  O
LTID:    PSATS      141
LTCLASS:  BRAFS
LINE CLASS CODE:    ISDNKSET
KEY:      1
CUSTGRP:           MDCSCA  SUBGRP:  O    NCOS:  O  RING:  Y
OPTIONS:
SFC
6ROUP OPTIONS:
CIR RCVD
MEMBER INFO:
  1      2257146
  2      2257145
  3      2257144
  4      2257143
  5      2257142
    
```

QLT PSATS 141

LTID: PSATS 141
 SNPA: 201
 DIRECTORY NUMBER: 2257141
 LT GROUP NO: 13
 LTCLASS: BRAFS DEFAULT LOGICAL TERMINAL: N
 EKTS: N CACH: N
 BEARER SERVICE RESTRICTIONS: NOPMD
 CS: Y PS: N
 VERSION: FUNCTIONAL ISSUE: 2
 SPID-SUFFIX: 01
 LEN: HOST 01 1 10 01 TEI: DYNAMIC
 CUSTGRP: MDCSCA SUBGRP: O NCOS: O RING: Y
 LINE CLASS CODE: ISDNKSET
 MAXKEYS: 64
 DN IS ASSIGNED AS A DNH HUNT PILOT.
 HUNT GROUP: 22 HUNT MEMBER: O
 OPTIONS:
 SFC

KEY	DN	
---	--	
1	DN	2257141

KEY	FEATURE
---	-----
	NONE

6GROUP OPTIONS:
 CIR RCVD
 MEMBER INFO:
 1 2257146
 2 2257145
 3 2257144
 4 2257143
 5 2257142

QLT PSATS 142

LTID: PSATS 142
 SNPA: 201
 DIRECTORY NUMBER: 2257142
 LT GROUP NO: 13
 LTCLASS: BRAFS DEFAULT LOGICAL TERMINAL: N
 EKTS: N CACH: N
 BEARER SERVICE RESTRICTIONS: NOPMD
 CS: Y PS: N
 VERSION: FUNCTIONAL ISSUE: 2
 SPID-SUFFIX: 01
 LEN: HOST 01 1 10 02 TEI: DYNAMIC
 CUSTGRP: MDCSCA SUBGRP: O NCOS: O RING: Y
 LINE CLASS CODE: ISDNKSET
 MAXKEYS: 64
 DN IS ASSIGNED AS A DNH HUNT MEMBER (NOT PILOT).
 HUNT GROUP: 22 HUNT MEMBER: 5
 OPTIONS:
 SFC

KEY	DN	
---	--	
1	DN	2257142

KEY	FEATURE
---	-----
	NONE

PILOT DN: 2257141
 GROUP OPTIONS:
 CIR RCVD

DN: 2257143
 TYPE: MEMBER OF DNH HUNT GROUP
 SNPA: 201 SIG: N/A LNATTIDX: N/A
 HUNT GROUP: 22 HUNT MEMBER: 4
 LTID: PSATS 143
 LTCLASS: BRAFS
 LINE CLASS CODE: ISDNKSET
 KEY: 1
 CUSTGRP: MDCSCA SUBGRP: O NCOS: O RING: Y
 OPTIONS:
 SFC
 PILOT DN: 2257141
 GROUP OPTIONS:
 CIR RCVD

```

LTID: PSATS 143
SNPA: 201
DIRECTORY NUMBER: 2257143
LT GROUP NO: 13
LTCLASS: BRAFS          DEFAULT LOGICAL TERMINAL: N
EKTS: N  CACH: N
BEARER SERVICE RESTRICTIONS:      NOPMD
CS: Y PS: N
VERSION: FUNCTIONAL ISSUE: 2
SPID-SUFFIX: 01
LEN: HOST 01 0 07 01  TEI: DYNAMIC
CUSTGRP: MDCSCA SUBGRP: O  NCOS: O  RING: Y
LINE CLASS CODE: ISDNKSET
MAXKEYS: 64
DN IS ASSIGNED AS A DNH HUNT MEMBER (NOT PILOT).
HUNT GROUP: 22          HUNT MEMBER: 4
OPTIONS:
SFC

```

```

KEY      DN
---      --
1        DN          2257143

```

```

KEY      FEATURE
---      -
NONE

```

```

PILOT DN: 2257141
GROUP OPTIONS:
CIR RCVD

```

QDN 2257144;QLT PSATS 144

```

DN: 2257144
TYPE: MEMBER OF DNH HUNT GROUP
SNPA: 201 SIG: N/A LNATTIDX: N/A
HUNT GROUP: 22 HUNT MEMBER: 3
LTID: PSATS 144
LTCLASS: BRAFS
LINE CLASS CODE: ISDNKSET
KEY: 1
CUSTGRP: MDCSCA SUBGRP: O  NCOS: O  RING: Y
OPTIONS:
SFC
PILOT DN: 2257141
GROUP OPTIONS:
CIR RCVD

```

```

LTID: PSATS      144
SNPA: 201
DIRECTORY NUMBER: 2257144
LT GROUP NO: 13
LTCLASS: BRAFS   DEFAULT LOGICAL TERMINAL: N
EKTS: N  CACH: N
BEARER SERVICE RESTRICTIONS: NOPMD
CS: Y PS: N
VERSION: FUNCTIONAL ISSUE: 2
SPID-SUFFIX: 01
LEN: HOST 01 1 10 01  TEI: DYNAMIC
CUSTGRP: MDCSCA SUBGRP: O NCOS: O RING: Y
LINE CLASS CODE: ISDNKSET
MAXKEYS: 64
DN IS ASSIGNED AS A DNH HUNT MEMBER (NOT PILOT).
HUNT GROUP: 22      HUNT MEMBER: 3
OPTIONS:
SFC

```

```

KEY      DN
---     --
1        DN      2257144

```

```

KEY      FEATURE
---     -
NONE

```

```

PILOT DN: 2257141
GROUP OPTIONS:
CIR RCVD

```

QDN 2257145;QLT PSATS 145

```

DN: 2257145
TYPE: MEMBER OF DNH HUNT GROUP
SNPA: 201 SIG: N/A LNATTIDX: N/A
HUNT GROUP: 22 HUNT HENBER: 2
LTID: PSATS 145
LTCLASS: BRAFS
LINE CLASS CODE: ISDNKSET
KEY: 1
CUSTGRP: MDCSCA SUBGRP: O NCOS: O RING: Y
OPTIONS:
SFC
PILOT DN: 2257141
GROUP OPTIONS:
CIR RCVD

```

```

LTID: PSATS      145
SNPA: 201
DIRECTORY NUMBER: 2257145
LT GROUP NO: 13
LTCLASS: BRAFS      DEFAULT LOGICAL TERMINAL: N
EKTS: N  CACH: N
BEARER SERVICE RESTRICTIONS:      NOPMD
CS: Y PS: N
VERSION: FUNCTIONAL ISSUE: 2
SPID-SUFFIX:      01
LEN: HOST 01 1 10 02      TEI: DYNAMIC
CUSTGRP:      MDCSCA  SUBGRP: O  NCOS: O  RING: Y
LINE CLASS CODE: ISDNKSET
MAXKEYS: 64
DN IS ASSIGNED AS A DNH HUNT MEMBER (NOT PILOT).
HUNT GROUP: 22      HUNT MEMBER: 2
OPTIONS:
SFC

```

```

KEY      DN
---      --
1      DN      2257145

```

```

KEY      FEATURE
---      -----
NONE

```

```

PILOT DN: 2257141
GROUP OPTIONS:
CIR RCVD

```

QDN 2257146;QLT PSATS 146

```

DN: 2257146
TYPE: MEMBER OF DNH HUNT GROUP
SNPA: 201  SIG: N/A  LNATTIDX: N/A
HUNT GROUP: 22      HUNT MEMBER: 1
LTID: PSATS      146
LTCLASS: BRAFS
LINE CLASS CODE: ISDNKSET
KEY: 1
CUSTGRP:      MDCSCA  SUBGRP: O  NCOS: O  RING: Y
OPTIONS:
SFC
PILOT DN: 2257141
GROUP OPTIONS:
CIR RCVD

```

```

LTID: PSATS 146
SNPA: 201
DIRECTORY NUMBER: 2257146
LT GROUP NO: 13
LTCLASS: BRAFS      DEFAULT LOGICAL TERMINAL: N
EKTS: N  CACH: N
BEARER SERVICE RESTRICTIONS:      NOPMD
CS: Y PS: N
VERSION: FUNCTIONAL  ISSUE: 2
SPID-SUFFIX:      01
LEN: HOST 01 0 07 01  TEI: DYNAMIC
CUSTGRP:          MDCSCA SUBGRP: O  NCOS: O  RING: Y
LINE CLASS CODE: ISDNKSET
MAXKEYS: 64
DN IS ASSIGNED AS A DNH HUNT MEMBER (NOT PILOT).
HUNT GROUP: 22      HUNT MEMBER: 1
OPTIONS:
SFC

```

```

KEY      DN
---      --
  1      DN      2257146

```

```

KEY      FEATURE
---      -
      NONE

```

```

PILOT DN: 2257141
GROUP OPTIONS:
CIR RCVD

```

```

QLEN 1 1 10 1;QLEN 1 1 10 2;QLEN 1 0 7 1

```

```

LEN:      HOST 01 1 10 01
ISG: 0 DCH: 1 ISG BRA Channel: 21
CARCODE: BX27AA      PADGRP: NPDGP
PM NODE NUMBER :      32
PM TERMINAL NUMBER:      322

```

TEI	LTID	CS	PS	BCH/ISG Bd
---	-----	--	--	-----
DYNAMIC	PSATS 141	Y	N	-
DYNAMIC	PSATS 144	Y	N	-

```

LEN:      HOST 01 1 10 02
ISG: 0 DCH: 1 ISG BRA Channel: 21
CARCODE: BX27AA      PADGRP: NPDGP
PM NODE NUMBER :    32
PM TERMINAL NUMBER:    323
    
```

TEI	LTID	CS	PS	BCH/ISG Bd
DYNAMIC	PSATS 142	Y	N	-
DYNAMIC	PSATS 145	Y	N	-

```

LEN:      HOST 01 0 07 01
ISG: 0 DCH: 1 ISG BRA Channel: 24
CARCODE: BX27AA      PADGRP: NPDGP
PM NODE NUMBER :    31
PM TERMINAL NUMBER:    226
    
```

TEI	LTID	CS	PS	BCH/ISG Bd
DYNAMIC	PSATS 143	Y	N	-
DYNAMIC	PSATS 146	Y	N	-

STOP2

Siemens SSC EWSD Switch Translations

For the Siemens SSC EWSD switch, Capability Package "S" includes alternate voice/circuit-switched data on two B-channels. It also supports Calling Number Identification on data and voice connections. Please note that the assignment of two Directory Numbers (DNs) is required for this package.

The Siemens SSC EWSD switch allows either voice or data hunting on one DN using the Series Completion feature. The same provisioning is used for either a voice or data series completion group.

ISDN Capability Package "S"

The information listed below provides the DN translations that define Capability Package "S", and the screens and fields that must be populated.

The information provided shows the translations for one DSL and two DNs. For multiple DSLs/DNs, the CO will duplicate these screens and enter the applicable DSL and DN values as needed.

ISDN Ordering Code: Capability S

DISPACCESS:EQN=20-0-5-4;	EXEC'D
ACCESS DATA	MASKNO:04328
	MASKNO:00000
EQN =20-0-5-4,	
CLOSS = 0,	
BCHEQN =2,	
BCEQN = SP & AU3 & C56 & C64,	
CPDDN = 2156855917-VI & 2156855917-CMD,	
CPVDN2 = 2156855917,	
COE = CLASS1,	
LINKOPT = DYNNOPAL,	
BAPROF = 0;	

DISPSUB:DN=6855917;	
NPA = 215 DN = 6855917 EQN = 20-0-5-4	MASKNO:03800
CAT = IBA	MASKNO:03774
BCHDN = 2	MASKNO:03798
BCDN = SP &AU3 &C56 &C64	MASKNO:04535
CT = VI	MASKNO:04396
LCC = BVCE RAX = 1	MASKNO:03785
BCHCT = 2	MASKNO:06282
IBCHCT = 2	MASKNO:06288
OBCHCT = 2	MASKNO:06291
PIC = 0288-SP	MASKNO:04398
& 0288-AU3	
CHRG = FRSA1	MASKNO:03775
COS = ICND & RND	MASKNO:03777
CRBLIM = 2	MASKNO:03798
CT = CMD	MASKNO:04396
LCC = BCMD RAX = 1	MASKNO:03785
BCHCT = 2	MASKNO:06282
IBCHCT = 2	MASKNO:06288
OBCHCT = 2	MASKNO:06291
PIC = 0288-C56	MASKNO:04398
& 0288-C64	
CHRG = FRSA1	MASKNO:03775
COS = ICND &RND	MASKNO:03777
CRBLM = 2	MASKNO:03798
DISPTSP:TSPID=215685591701	MASKNO:04383
EQN: 20-0-5-4	
USID: 5	
TSPID: 215685591701	
TERMLIM: 1	MASKNO:04386
DN: 6855917	MASKNO:04382
CT: VI	MASKNO:04385
DN: 6855917	MASKNO:04382
CT: CMD	MASKNO:04385

DISPSUB:DN=6855919;	
NPA = 215 DN = 6855919 EQN = 20-0-5-4	MASKNO:03800
CAT = IBA	MASKNO:03774
BCHDN = 2	MASKNO:03798
BCDN = SP &AU3 &C56 &C64	MASKNO:04535
CT = VI	MASKNO:04396
LCC =BVCE RAX = 1	MASKNO:03785
BCHCT = 2	MASKNO:06282
IBCHCT = 2	MASKNO:06288
OBCHCT = 2	MASKNO:06291
PIC = 0288-SP	MASKNO:04398
& 0288-AU3	
CHRG = FRSA1	MASKNO:03775
COS = ICND & RND	MASKNO:03777
CRBLIM = 2	MASKNO:03798
CT = CMD	MASKNO:04396
LCC = BCMD RAX = 1	MASKNO:03785
BCHCT = 2	MASKNO:06282
IBCHCT = 2	MASKNO:06288
OBCHCT = 2	MASKNO:06291
PIC = 0288-C56	MASKNO:04398
& 0288-C64	
CHRG = FRSA1	MASKNO:03775
COS = ICND &RND	MASKNO:03777
CRBLIM = 2	MASKNO:03798
DISPTSP:TSPID=215685591901;	MASKNO:04383
EQN: 20-0-5-4	
USID: 1	
TSPID: 215685591901	
TERMLIM: 1	MASKNO:04386
DN: 6855919	MASKNO:04382
CT: VI	MASKNO:04385
DN: 6855919	MASKNO:04382
CT: CMD	MASKNO:04385

Series Completion Feature Translations

The information listed below provides the translation for either voice or data hunting on three Digital Subscriber Lines (DSLs) and six Directory Numbers (DNs) forming a circular series completion group.

The screens shown in this section are examples, DNs shown on these screens should be replaced with applicable data.

M	NAVK1/BELLCORNJRB/APS 13.0 PS0071/000 0959 OMT-00/LEONLY 2816/04328	96-01-18	16:22:05
	DISPSDNDAT:EQN=20-0-0-1&20-0-5-0&40-0-2-4:		EXEC'D
	ISDN ACCESS DATA		MASKNO:04328 MASKNO:00000
	VIEW = EQN. EQN = 20-0-00-01. BCHEQN = 2. BCEQN = SP. BCEQN = AU3. BCEQN = C56. BCEQN = C64. CPDDN = 2156851189-VI. CPDDN = 2156851189-CMD. COE = CLASS1. LINKOPT = DYNNOPAL. NCCSL = D1--4. NCCSL = D2--4. NPCSL = P1--0. NPCSL = P2--0. NSL = 10. L2TIM = T200-10. L2TIM = T201-10. L2TIM = T203-3. L2COUNT = N200-3. L2COUNT = OIFDCC-1. L2COUNT = OIFDPC-3. CPVDN2 = 2156851189. CPVDN2 = 2156851289:		
	INTERRUPTION TEXT JOB 0959		

CONTINUATION TEXT 0001

M NAVK1/BELLCORNJRB/APS 13.0 PS0071/000 96-01-18 16:22:08
 0959 OMT-00/LEONLY 2816/04328

SUBSCRIBER

MASKNO:04328
 MASKNO:00000

VIEW = DN.
 NPA = 215.
 DN = 6851189.
 EQN = 20-0-00-01.
 BCHDN = 2.
 BCDN = SP.
 BCDN = AU3.
 BCDN = C56.
 BCDN = C64.
 BCHCT = 2-VI.
 BCHCT = 2-CMD.
 BCHCT = 0-PMD.
 IBCHCT = 2-VI.
 IBCHCT = 2-CMD.
 IBCHCT = 0-PMD.
 OBCHCT = 2-VI.
 OBCHCT = 2-CMD.
 OBCHCT = 0-PMD.
 CT = VI.
 C1 = CMD:

INTERRUPTION TEXT JOB 0959

CONTINUATION TEXT 0002

M NAVK1/BELLCORNJRB/APS 13.0 PS0071/000 96-01-18 16:22:31
 0959 OMT-00/LEONLY 2816/04328

SUBSCRIBER

MASKNO:04328
 MASKNO:00000

VIEW = DNCT.
 NPA = 215.
 DN = 6851189.
 EQN = 20-0-00-01.
 CT = VI.
 CAT = IBA.
 LCC = PKGSV.
 RAX = 1.
 COS = ICND.
 COS = RND.
 COSDAT = SERCOMP-6851289.
 PIC = 222-SP.
 PIC = 288-AU3.
 CRBLIM = 1:

INTERRUPTION TEXT JOB 0959

CONTINUATION TEXT 0003

NAVK1/BELLCORNJRB/APS 13.0 PS0071/000 96-01-18 16:22:15
M 0959 OMT-00/LEONLY 2816/04328

SUBSCRIBER

MASKNO:04328
MASKNO:00000

VIEW = DNCT.
NPA = 215.
DN = 6851189.
EQN = 20-0-00-01.
CT = CMD.
CAT = IBA.
LCC = PKGSD.
RAX = 1.
COS = ICND.
COS = RND.
COSDAT = SERCOMP-6851289.
PIC = 222-C56.
PIC = 288-C64.
CRBLIM = 1:

INTERRUPTION TEXT JOB 0959

CONTINUATION TEXT 0004

NAVK1/BELLCORNJRB/APS 13.0 PS0071/000 96-01-18 16:22:19
M 0959 OMT-00/LEONLY 2816/04328

SUBSCRIBER

MASKNO:04328
MASKNO:00000

VIEW = DN.
NPA = 215.
DN = 6851289.
EQN = 20-0-00-01.
BCHDN = 2.
BCDN = SP.
BCDN = AU3.
BCDN = C56.
BCDN = C64.
BCHCT = 2-VI.
BCHCT = 2-CMD.
BCHCT = 0-PMD.
IBCHCT = 2-VI.
IBCHCT = 2-CMD.
IBCHCT = 0-PMD.
OBCHCT = 2-VI.
OBCHCT = 2-CMD.
OBCHCT = 0-PMD.
CT = VI.
CT = CMD:

INTERRUPTION TEXT JOB 0959

CONTINUATION TEXT 0005

M NAVK1/BELLCORNJRB/APS 13.0 PS0071/000 96-01-18 16:22:22
0959 OMT-00/LEONLY 2816/04328

SUBSCRIBER MASKNO:04328
MASKNO:00000

VIEW = DNCT.
NPA = 215.
DN = 6851289.
EQN = 20-0-00-01.
CT = VI.
CAT = IBA.
LCC = PKGSV.
RAX = 1.
COS = ICND.
COS = RND.
COSDAT = SERCOMP-6852199.
PIC = 222-SP.
PIC = 288-AU3.
CRBLIM = 1:

INTERRUPTION TEXT JOB 0959

CONTINUATION TEXT 0006

M NAVK1/BELLCORNJRB/APS 13.0 PS0071/000 96-01-18 16:22:26
0959 OMT-00/LEONLY 2816/04328

SUBSCRIBER MASKNO:04328
MASKNO:00000

VIEW = DNCT.
NPA = 215.
DN = 6851289.
EQN = 20-0-00-01.
CT = CMD.
CAT = IBA.
LCC = PKGSD.
RAX = 1.
COS = ICND.
COS = RND.
COSDAT = SERCOMP-6852199.
PIC = 222-C56.
PIC = 288-C64.
CRBLIM = 1:

INTERRUPTION TEXT JOB 0959

CONTINUATION TEXT 0007
 NAVK1/BELLCORNJRB/APS 13.0 PS0071/000 96-01-18 16:22:29
 M 0959 OMT-00/LEONLY 2816/04328

TERMINAL SERVICE PROFILE DATA MASKNO:04328
 MASKNO:00000

VIEW = TSP.
 EQN = 20-0-00-01.
 USID = 1.
 TSPID = 2156851189.
 TERMLIM = 1.
 TSPCOS = CHDBCHR:

INTERRUPTION TEXT JOB 0959

CONTINUATION TEXT 0008
 NAVK1/BELLCORNJRB/APS 13.0 PS0071/000 96-01-18 16:22:32
 M 0959 OMT-00/LEONLY 2816/04328

TERMINAL SERVICE PROFILE DATA MASKNO:04328
 MASKNO:00000

VIEW = TSPDNCT.
 EQN = 20-0-00-01.
 TSPID = 2156851189.
 NPA = 215.
 DN = 6851189.
 CT= VI:

INTERRUPTION TEXT JOB 0959

CONTINUATION TEXT 0009
 NAVK1/BELLCORNJRB/APS 13.0 PS0071/000 96-01-18 16:22:35
 M 0959 OMT-00/LEONLY 2816/04328

TERMINAL SERVICE PROFILE DATA MASKNO:04328
 MASKNO:00000

VIEW = TSPDNCT.
 EQN = 20-0-00-01.
 TSPID = 2156851189.
 NPA = 215.
 DN = 6851189.
 CT= CMD:

INTERRUPTION TEXT JOB 0959

CONTINUATION TEXT 0010

	NAVK1/BELLCORNJRB/APS 13.0 PS0071/000	96-01-18	16:22:38
M	0959 OMT-00/LEONLY 2816/04328		

TERMINAL SERVICE PROFILE DATA

MASKNO:04328
 MASKNO:00000

VIEW = TSP.
 EQN = 20-0-00-01.
 USID = 2.
 TSPID = 2156851289.
 TERMLIM = 1.
 TSPCOS = CHDBCHR:

INTERRUPTION TEXT JOB 0959

CONTINUATION TEXT 0011

	NAVK1/BELLCORNJRB/APS 13.0 PS0071/000	96-01-18	16:22:40
M	0959 OMT-00/LEONLY 2816/04328		

ISDN ACCESS DATA

MASKNO:04328
 MASKNO:00000

VIEW = EQN.
 EQN = 20-0-05-01.
 BCHEQN = 2.
 BCEQN = SP.
 BCEQN = AU3.
 BCEQN = C56.
 BCEQN = C64.
 CPDDN = 2156852199-VI.
 CPDDN = 2156852199-CMD.
 COE = CLASS1.
 LINKOPT = DYNNOPAL.
 NCCSL = D1--4.
 NCCSL = D2--4.
 NPCSL = P1--0.
 NPCSL = P2--0.
 NSL = 10.
 L2TIM = T200-10.
 L2TIM = T201-10.
 L2TIM = T203-3.
 L2COUNT = N200-3.
 L2COUNT = OIFDCC-1.
 L2COUNT = OIFDPC-3.
 CPVDN2 = 2156852199.
 CPVDN2 = 2156852299:

INTERRUPTION TEXT JOB 0959

CONTINUATION TEXT 0012

NAVK1/BELLCORNJRB/APS 13.0 PS0071/000 96-01-18 16:22:44
M 0959 OMT-00/LEONLY 2816/04328

SUBSCRIBER

MASKNO:04328
MASKNO:00000

VIEW = DN.
NPA = 215.
DN = 6852199.
EQN = 20-0-05-00.
BCHDN = 2.
BCDN = SP.
BCDN = AU3.
BCDN = C56.
BCDN = C64.
BCHCT = 2-VI.
BCHCT = 2-CMD.
BCHCT = 0-PMD.
IBCHCT = 2-VI.
IBCHCT = 2-CMD.
IBCHCT = 0-PMD.
OBCHCT = 2-VI.
OBCHCT = 2-CMD.
OBCHCT = 0-PMD.
CT = VI.
CT = CMD:

INTERRUPTION TEXT JOB 0959

CONTINUATION TEXT 0013

NAVK1/BELLCORNJRB/APS 13.0 PS0071/000 96-01-18 16:22:48
M 0959 OMT-00/LEONLY 2816/04328

SUBSCRIBER

MASKNO:04328
MASKNO:00000

VIEW = DNCT.
NPA = 215.
DN = 6852199.
EQN = 20-0-05-00.
CT = VI.
CAT = IBA.
LCC = PKGSV.
RAX = 1.
COS = ICND.
COS = RND.
COSDAT = SERCOMP-6852299.
PIC = 222-SP.
PIC = 288-AU3.
CRBLIM = 1:

INTERRUPTION TEXT JOB 0959

CONTINUATION TEXT 0014

M NAVK1/BELLCORNJRB/APS 13.0 PS0071/000 96-01-18 16:22:51
0959 OMT-00/LEONLY 2816/04328

SUBSCRIBER

MASKNO:04328
MASKNO:00000

VIEW = DNCT.
NPA = 215.
DN = 6852199.
EQN = 20-0-05-00.
CT = CMD.
CAT = IBA.
LCC = PKGSD.
RAX = 1.
COS = ICND.
COS = RND.
COSDAT = SERCOMP-6852299.
PIC = 222-C56.
PIC = 288-C64.
CRBLIM = 1:

INTERRUPTION TEXT JOB 0959

CONTINUATION TEXT 0015

M NAVK1/BELLCORNJRB/APS 13.0 PS0071/000 96-01-18 16:22:55
0959 OMT-00/LEONLY 2816/04328

SUBSCRIBER

MASKNO:04328
MASKNO:00000

VIEW = DN.
NPA = 215.
DN = 6852299.
EQN = 20-0-05-00.
BCHDN = 2.
BCDN = SP.
BCDN = AU3.
BCDN = C56.
BCDN = C64.
BCHCT = 2-VI.
BCHCT = 2-CMD.
BCHCT = 0-PMD.
IBCHCT = 2-VI.
IBCHCT = 2-CMD.
IBCHCT = 0-PMD.
OBCHCT = 2-VI.
OBCHCT = 2-CMD.
OBCHCT = 0-PMD.
CT = VI.
CT = CMD:

INTERRUPTION TEXT JOB 0959

CONTINUATION TEXT 0016

	NAVK1/BELLCORNJRB/APS 13.0 PS0071/000	96-01-18	16:22:58
M	0959 OMT-00/LEONLY 2816/04328		

SUBSCRIBER	MASKNO:04328
	MASKNO:00000

VIEW = DNCT.
 NPA = 215.
 DN = 6852299.
 EQN = 20-0-05-00.
 CT = VI.
 CAT = IBA.
 LCC = PKGSV.
 RAX = 1.
 COS = ICND.
 COS = RND.
 COSDAT = SERCOMP-6853119.
 PIC = 222-SP.
 PIC = 288-AU3.
 CRBLIM = 1:

INTERRUPTION TEXT JOB 0959

CONTINUATION TEXT 0017

	NAVK1/BELLCORNJRB/APS 13.0 PS0071/000	96-01-18	16:23:01
M	0959 OMT-00/LEONLY 2816/04328		

SUBSCRIBER	MASKNO:04328
	MASKNO:00000

VIEW = DNCT.
 NPA = 215.
 DN = 6852299.
 EQN = 20-0-05-00.
 CT = CMD.
 CAT = IBA.
 LCC = PKGSD.
 RAX = 1.
 COS = ICND.
 COS = RND.
 COSDAT = SERCOMP-6853119.
 PIC = 222-C56.
 PIC = 288-C64.
 CRBLIM = 1:

INTERRUPTION TEXT JOB 0959

CONTINUATION TEXT 0018
 NAVK1/BELLCORNJRB/APS 13.0 PS0071/000 96-01-18 16:23:05
 M 0959 OMT-00/LEONLY 2816/04328

 TERMINAL SERVICE PROFILE DATA MASKNO:04328
 MASKNO:00000

 VIEW = TSP.
 EQN = 20-0-05-00.
 USID = 1.
 TSPID = 2156852199.
 TERMLIM = 1.
 TSPCOS = CHDBCHR:
 INTERRUPTION TEXT JOB 0959

CONTINUATION TEXT 0019
 NAVK1/BELLCORNJRB/APS 13.0 PS0071/000 96-01-18 16:23:07
 M 0959 OMT-00/LEONLY 2816/04328

 TERMINAL SERVICE PROFILE DATA MASKNO:04328
 MASKNO:00000

 VIEW = TSPDNCT.
 EQN = 20-0-05-00.
 TSPID = 2156852199.
 NPA = 215.
 DN = 6852199.
 CT= VI:
 INTERRUPTION TEXT JOB 0959

CONTINUATION TEXT 0020
 NAVK1/BELLCORNJRB/APS 13.0 PS0071/000 96-01-18 16:23:11
 M 0959 OMT-00/LEONLY 2816/04328

 TERMINAL SERVICE PROFILE DATA MASKNO:04328
 MASKNO:00000

 VIEW = TSPDNCT.
 EQN = 20-0-05-00.
 TSPID = 2156852199.
 NPA = 215.
 DN = 6852199.
 CT= CMD:
 INTERRUPTION TEXT JOB 0959

CONTINUATION TEXT 0021
 NAVK1/BELLCORNJRB/APS 13.0 PS0071/000 96-01-18 16:23:13
 M 0959 OMT-00/LEONLY 2816/04328

TERMINAL SERVICE PROFILE DATA MASKNO:04328
 MASKNO:00000

VIEW = TSP.
 EQN = 20-0-05-00.
 USID = 2.
 TSPID = 2156852299.
 TERMLIM = 1.
 TSPCOS = CHDBCHR:

INTERRUPTION TEXT JOB 0959

CONTINUATION TEXT 0022
 NAVK1/BELLCORNJRB/APS 13.0 PS0071/000 96-01-18 16:23:16
 M 0959 OMT-00/LEONLY 2816/04328

ISDN ACCESS DATA MASKNO:04328
 MASKNO:00000

VIEW = EQN.
 EQN = 40-0-02-04.
 BCHEQN = 2.
 BCEQN = SP.
 BCEQN = AU3.
 BCEQN = C56.
 BCEQN = C64.
 CPDDN = 2156853119-VI.
 CPDDN = 2156853119-CMD.
 COE = CLASS1.
 LINKOPT = DYNNOPAL.
 NCCSL = D1--4.
 NCCSL = D2--4.
 NPCSL = P1--0.
 NPCSL = P2--0.
 NSL = 10.
 L2TIM = T200-10.
 L2TIM = T201-10.
 L2TIM = T203-3.
 L2COUNT = N200-3.
 L2COUNT = OIFDCC-1.
 L2COUNT = OIFDPC-3.
 CPVDN2 = 2156853119.
 CPVDN2 = 2156853219:

INTERRUPTION TEXT JOB 0959

CONTINUATION TEXT 0023

NAVK1/BELLCORNJRB/APS 13.0 PS0071/000 96-01-18 16:23:20
M 0959 OMT-00/LEONLY 2816/04328

SUBSCRIBER

MASKNO:04328
MASKNO:00000

VIEW = DN.
NPA = 215.
DN = 6853119.
EQN = 40-0-02-04.
BCHDN = 2.
BCDN = SP.
BCDN = AU3.
BCDN = C56.
BCDN = C64.
BCHCT = 2-VI.
BCHCT = 2-CMD.
BCHCT = 0-PMD.
IBCHCT = 2-VI.
IBCHCT = 2-CMD.
IBCHCT = 0-PMD.
OBCHCT = 2-VI.
OBCHCT = 2-CMD.
OBCHCT = 0-PMD.
CT = VI.
CT = CMD:

INTERRUPTION TEXT JOB 0959

CONTINUATION TEXT 0024

NAVK1/BELLCORNJRB/APS 13.0 PS0071/000 96-01-18 16:23:23
M 0959 OMT-00/LEONLY 2816/04328

SUBSCRIBER

MASKNO:04328
MASKNO:00000

VIEW = DNCT.
NPA = 215.
DN = 6853119.
EQN = 40-0-02-04.
CT = VI.
CAT = IBA.
LCC = PKGSV.
RAX = 1.
COS = ICND.
COS = RND.
COSDAT = SERCOMP-6853219.
PIC = 222-SP.
PIC = 288-AU3.
CRBLIM = 1:

INTERRUPTION TEXT JOB 0959

CONTINUATION TEXT 0025

NAVK1/BELLCORNJRB/APS 13.0 PS0071/000 96-01-18 16:23:27
M 0959 OMT-00/LEONLY 2816/04328

SUBSCRIBER

MASKNO:04328
MASKNO:00000

VIEW = DNCT.
NPA = 215.
DN = 6853119.
EQN = 40-0-02-04.
CT = CMD.
CAT = IBA.
LCC = PKGSD.
RAX = 1.
COS = ICND.
COS = RND.
COSDAT = SERCOMP-6853219.
PIC = 222-C56.
PIC = 288-C64.
CRBLIM = 1:

INTERRUPTION TEXT JOB 0959

CONTINUATION TEXT 0026

NAVK1/BELLCORNJRB/APS 13.0 PS0071/000 96-01-18 16:23:30
M 0959 OMT-00/LEONLY 2816/04328

SUBSCRIBER

MASKNO:04328
MASKNO:00000

VIEW = DN.
NPA = 215.
DN = 6853219.
EQN = 40-0-02-04.
BCHDN = 2.
BCDN = SP.
BCDN = AU3.
BCDN = C56.
BCDN = C64.
BCHCT = 2-VI.
BCHCT = 2-CMD.
BCHCT = 0-PMD.
IBCHCT = 2-VI.
IBCHCT = 2-CMD.
IBCHCT = 0-PMD.
OBCHCT = 2-VI.
OBCHCT = 2-CMD.
OBCHCT = 0-PMD.
CT = VI.
CT = CMD:

INTERRUPTION TEXT JOB 0959

CONTINUATION TEXT 0027

M NAVK1/BELLCORNJRB/APS 13.0 PS0071/000 96-01-18 16:23:34
0959 OMT-00/LEONLY 2816/04328

SUBSCRIBER MASKNO:04328
MASKNO:00000

VIEW = DNCT.
NPA = 215.
DN = 6853219.
EQN = 40-0-02-04.
CT = VI.
CAT = IBA.
LCC = PKGSV.
RAX = 1.
COS = ICND.
COS = RND.
COSDAT = SERCOMP-6851189.
PIC = 222-SP.
PIC = 288-AU3.
CRBLIM = 1:

INTERRUPTION TEXT JOB 0959

CONTINUATION TEXT 0028

M NAVK1/BELLCORNJRB/APS 13.0 PS0071/000 96-01-18 16:23:37
0959 OMT-00/LEONLY 2816/04328

SUBSCRIBER MASKNO:04328
MASKNO:00000

VIEW = DNCT.
NPA = 215.
DN = 6853219.
EQN = 40-0-02-04.
CT = CMD.
CAT = IBA.
LCC = PKGSD.
RAX = 1.
COS = ICND.
COS = RND.
COSDAT = SERCOMP-6851189.
PIC = 222-C56.
PIC = 288-C64.
CRBLIM = 1:

INTERRUPTION TEXT JOB 0959

CONTINUATION TEXT 0029
 NAVK1/BELLCORNJRB/APS 13.0 PS0071/000 96-01-18 16:23:40
 M 0959 OMT-00/LEONLY 2816/04328

TERMINAL SERVICE PROFILE DATA MASKNO:04328
 MASKNO:00000

VIEW = TSP.
 EQN = 40-0-02-04.
 USID = 1.
 TSPID = 2156853119.
 TERMLIM = 1.
 TSPCOS = CHDBCHR:

INTERRUPTION TEXT JOB 0959

CONTINUATION TEXT 0030
 NAVK1/BELLCORNJRB/APS 13.0 PS0071/000 96-01-18 16:23:43
 M 0959 OMT-00/LEONLY 2816/04328

TERMINAL SERVICE PROFILE DATA MASKNO:04328
 MASKNO:00000

VIEW = TSPDNCT.
 EQN = 40-0-02-04.
 TSPID = 2156853119.
 NPA = 215.
 DN = 6853119.
 CT= VI:

INTERRUPTION TEXT JOB 0959

CONTINUATION TEXT 0031
 NAVK1/BELLCORNJRB/APS 13.0 PS0071/000 96-01-18 16:23:46
 M 0959 OMT-00/LEONLY 2816/04328

TERMINAL SERVICE PROFILE DATA MASKNO:04328
 MASKNO:00000

VIEW = TSPDNCT.
 EQN = 40-0-02-04.
 TSPID = 2156853119.
 NPA = 215.
 DN = 6853119.
 CT= CMD:

INTERRUPTION TEXT JOB 0959

CONTINUATION TEXT 0032

NAVK1/BELLCORNJRB/APS 13.0 PS0071/000 96-01-18 16:23:49
M 0959 OMT-00/LEONLY 2816/04328

TERMINAL SERVICE PROFILE DATA

MASKNO:04328
MASKNO:00000

VIEW = TSP.

EQN = 40-0-02-04.

USID = 2.

TSPID = 2156853219.

TERMLIM = 1.

TSPCOS = CHDBCHR:

END JOB 0959 EXEC'D

Glossary

#

7500B data module See *ISDN 7500B Data Module*.

A

account code Code used to associate incoming and outgoing calls with corresponding accounts, employees, projects, and clients.

ACCUNET AT&T's switched digital service for 56-kbps, 64-kbps restricted, and 64-kbps clear circuit-switched data calls.

address A coded representation of the destination of data or of the data's originating terminal, such as the dialed extension number assigned to the data terminal. Multiple terminals on one communication line must each have a unique address.

ADDS (Automated Document Delivery System) Computer-based application that stores documents in a database and automatically faxes them on request.

adjunct Optional equipment used with the communications system, such as an alerting device or *modem* that connects to a multiline telephone or to an extension jack.

ALS (Automatic Line Selection) Programmed order in which the system makes outside lines available to a user.

AMI (alternate mark inversion) Line coding format in which a binary one is represented by a positive or negative pulse, a binary zero is represented by no line signal, and subsequent binary ones must alternate in polarity; otherwise, a *bipolar violation* occurs. AMI is used in the *DS1* interface.

analog transmission Mode of transmission in which information is represented in continuously variable physical quantities such as amplitude, frequency, phase, or resistance. See also *digital transmission*.

Analog data station See *modem data station*.

ANI (automatic number identification) Process of automatically identifying a caller's billing number and transmitting that number from the caller's local central office to another point on or off the public network.

application	Software and/or hardware that adds functional capabilities to the system. For example, MERLIN Identifier is an application that provides caller identification information (if available in the local area or jurisdiction).
ARS	(Automatic Route Selection) System feature that routes calls on outside trunks according to the number dialed and trunk availability.
ASCAP	(American Society of Composers, Artists, and Producers)
ASN	(AT&T Switched Network) AT&T telecommunications services provided through an Integrated Digital Services Network Primary Rate Interface (ISDN-PRI) trunk, <i>Accunet</i> switched digital service, <i>Megacom</i> , <i>Megacom 800</i> , Software Defined Network (<i>SDN</i>), Multiquest, and Shared Access for Switch Services (<i>SASS</i>).
asynchronous data transmission	A method of transmitting a short bitstream of digital data, such as printable characters represented by a 7- or 8-bit ASCII code. Each string of data bits is preceded by a start bit and followed by a stop bit, thus permitting data to be transmitted at irregular intervals. See also <i>synchronous data transmission</i> .
AT&T Attendant	Application with equipment that connects to one or more <i>tip/ring</i> extension jacks and automatically answers incoming calls with a recorded announcement; directs calls in response to touch tones.
AT&T Switched Network	See <i>ASN</i> .
AUDIX Voice Power	A voice-processing application, part of <i>IS II/III</i> , that provides Automated Attendant, Call Answer, Information Service, Message Drop, Voice Mail, and, optionally, <i>Fax Attendant System</i> for use with the system.
Automated Attendant	<i>IS II/III</i> , <i>MERLIN MAIL</i> , and <i>MERLIN Attendant</i> application that automatically answers incoming calls with a recorded announcement and directs callers to a department, an extension, or the system operator.
Automatic Line Selection	See <i>ALS</i> .
Automatic Number Identification	See <i>ANI</i> .
automatic ringdown tie-trunk	See <i>automatic-start tie trunk</i> .

Automatic Route Selection	See <i>ARS</i> .
automatic-start tie trunk	<i>Tie trunk</i> on which incoming calls are routed to an operator or other designated destination without a start signal, as soon as the trunk is seized; the destination is specified during programming. Also called "automatic ringdown" or "auto-in" tie trunk.
auxiliary power unit	Device that provides additional power to the system.

B

B8ZS	(bipolar 8 zero substitution) Line-coding format that encodes a string of eight zeros in a unique binary sequence to detect <i>bipolar violation</i> . See also <i>bipolar signal</i> .
backup	Procedure for saving a copy of system programming onto a floppy disk or <i>memory card</i> . See also <i>restore</i> .
bandwidth	Difference, expressed in hertz, between the highest and lowest frequencies in a range that determines channel capacity.
barrier code	Password used to limit access to the <i>Remote Access</i> feature of the system.
basic carrier	Hardware that holds and connects the <i>processor</i> , <i>power supply</i> , and up to five modules in the system. See also <i>expansion carrier</i> .
baud rate	Strictly speaking, a measurement of transmission speed equal to the number of signal level changes per second. In practice, often used synonymously with <i>bit rate</i> and <i>bps</i> .
B-channel	(Bearer-channel) 64-kbps channel that carries a variety of digital information streams, such as voice at 64 kbps, data at up to 64 kbps, wideband voice encoded at 64 kbps, and voice at less than 64 kbps, alone or combined.
Bearer-channel	See <i>B-channel</i> .
Behind Switch mode	One of three modes of system operation, in which the control unit is connected to (behind) another telephone switching system, such as <i>Centrex</i> or <i>DEFINITY</i> , which provides features and services to telephone users. See also <i>Hybrid/PBX mode</i> and <i>Key mode</i> .

binary code	Electrical representation of quantities or symbols expressed in the base-2 number system, which includes zeros and ones.
bipolar 8 zero substitution	See <i>B8ZS</i> .
bipolar signal	Digital signal in which pulses (ones) alternate between positive and negative. See also <i>AMI</i> , <i>B8ZS</i> , and <i>bipolar violation</i> .
bipolar violation	Condition occurring when two positive or two negative pulses are received in succession. See also <i>AMI</i> and <i>B8ZS</i> .
BIS	(Built-In Speakerphone) Part of the model name of some analog multiline telephones.
bit	(binary digit) One unit of information in binary notation; it can have one of two values, zero or one.
bit rate	Speed at which bits are transmitted, usually expressed in <i>bps</i> . Also called "data rate." See also <i>baud rate</i> .
blocking	Condition in which end-to-end connections cannot be made on calls because of a full load on all possible services and facilities. See also <i>glare</i> .
BMI	(Broadcast Music Incorporated)
board	A <i>module</i> , for example, 100D or 408 MLX GS/LS, that allows you to connect lines/trunks and extensions to the communications system.
board assignment	<i>SPM</i> procedure for assigning <i>line/trunk and extension modules</i> to slots on the <i>control unit</i> .
board renumbering	System programming procedure for renumbering <i>line/trunk and extension</i> modules that have already been assigned to specific <i>slots</i> on the <i>control unit</i> .
BRI	(Basic Rate Interface) Standard digital <i>framing format</i> that specifies the protocol between the communication system and a terminal. BRI runs at 19.2-kbps and provides two 64-kbps voice or B-channels and on 16-kbps signaling or D-channel per port. The remaining 48-kbps are used for framing and D-channel contention.
broadband	Transmission path having a bandwidth greater than a voice-grade channel.
BTMI	(basic telephone modem interface)

bus	Multiconductor electrical path used to transfer information over a common connection from any of several sources to any of several destinations.
button	Key on the face of a telephone that is used to access a line, activate a feature, or enter a code on a communications system.
byte	Sequence of <i>bits</i> (usually eight) processed together. Also called "octet."

C

Call Accounting System	See <i>CAS</i> .
Call Accounting Terminal	See <i>CAT</i> .
Caller ID	A service provided by some local telephone companies (if local regulations allow) that supplies the calling party telephone number. In Release 3.0 and later, an 800 GS/LS-ID module on the system can capture this information and display it on the screens of MLX telephones. See also <i>ANI</i> .
Calling group	Team of individuals who answer the same types of calls.
Call Management System	See <i>CMS</i> .
campus cable	Cable that runs between buildings connected to the same communications system.
CAS	(Call Accounting System) DOS- or UNIX System-based application that monitors and manages telecommunications costs.
CAT	(Call Accounting Terminal) Stand-alone unit with a built-in microprocessor and data buffer that provides simple call accounting at a low cost.
CCITT	(International Telegraph and Telephone Consultative Committee)

CCS	(common-channel signaling) Signaling in which one <i>channel</i> of a group of channels carries signaling information for each of the remaining channels, permitting each of the remaining channels to be used to nearly full capacity. In the system's 100D module, channel 24 can be designated as the signaling channel for channels 1–23.
centralized telephone programming	Programming of features on individual telephones; performed at a central location by the <i>system manager</i> . See also <i>system programming</i> and <i>extension programming</i> .
central office	See <i>CO</i> .
Centrex	Set of system features to which a user can subscribe on telephone lines/trunks from the local telephone company.
channel	Telecommunications transmission path for voice and/or data.
channel service unit	See <i>CSU</i> .
checksum	Sum of ones in a sequence of ones and zeros used to detect or correct errors in data transmission.
circuit-switched data call	Data call made through an exclusively established and maintained connection between <i>data stations</i> .
class of restriction	See <i>COR</i> .
clear data channel	Clear data channels (also called unrestricted data channels) allow the transmission of occurrences of more than seven contiguous zero bits. If a clear data channel is requested and only restricted channels are available, the call will be rejected. See also restricted data channel.
clock synchronization	Operation of digital facilities from a common clock.
CMS	(Call Management System) DOS-based application that simulates the actions of a system operator by answering and distributing calls. Also produces reports for call analysis.
CO	(central office) Location of telephone switching equipment that provides local telephone service and access to toll facilities for long-distance calling.
coaxial cable	Cable consisting of one conductor, usually a small copper tube or wire within and insulated from another conductor of larger diameter, usually copper tubing or copper braid.

codec	(coder-decoder) Device used to convert analog signals such as speech, music, or television to digital form for transmission over a digital medium and back to the original analog form.
common channel signaling	See <i>CCS</i> .
communications system	Software-controlled processor complex that interprets dialing pulses, tones, and or keyboard characters and makes the proper interconnections both inside and outside. Consists of a computer, software, a storage device, and <i>carriers</i> with special hardware to perform the actual connections. Provides voice and/or data communications services, including access to public and private networks, for telephones and other equipment. Also referred to in this guide as "system," short for MERLIN LEGEND Communications System.
control unit	<i>Processor module, power supply modules, line/trunk and extension modules, carriers, and housing of the system.</i>
console	Refers to telephone and adjuncts (if any) at operator or system programmer extension.
CONVERSANT	Entry-level voice response application that automatically answers and routes calls and executes telephone transactions.
conversion resource	See <i>modem pool</i> .
COR	(class of restriction) Various types of restrictions that can be assigned to <i>remote access</i> trunks or barrier codes. These restrictions consist of calling restrictions, <i>ARS</i> Facility Restriction Levels (<i>FRLs</i>), Allowed Lists, Disallowed Lists, and Automatic Callback queuing.
Coverage	Set of system features that can determine how extensions' calls are covered when the person at the extension is busy or not available.
CRC	(cyclic redundancy check) An error-detection code used on <i>DS1</i> facilities with the extended superframe format (<i>ESF</i>).
CSU	(channel service unit) Equipment used on customer premises to provide <i>DS1</i> facility terminations and signaling compatibility.
cyclic redundancy check	See <i>CRC</i> .

D

D4 framing format	<i>Framing format</i> consisting of a sequence of individual frames of 24 eight-bit slots and one signal bit (193 bits) in a 12-frame superframe. See also <i>ESF</i> .
Data-channel	See <i>D-channel</i> .
data communications equipment	See <i>DCE</i> .
data hunt group	See <i>DHG</i> .
data module	See <i>ISDN terminal adapter</i> .
data rate	See <i>bps</i> .
data station	Special type of extension where data communications take place; includes <i>DTE</i> and <i>DCE</i> ; sometimes a telephone is also part of a data station.
data terminal	An input/output (<i>I/O</i>) device (often a personal computer) that can be connected to the control unit by an interface.
data terminal equipment	See <i>DTE</i> and <i>data terminal</i> .
DCE	(data communications equipment) Equipment such as <i>modems</i> or data modules used to establish, maintain, and terminate a connection between the system and data terminal equipment (<i>DTE</i>), such as printers, personal computers, host computers, or network workstations.
D-channel	(Data-channel) 64-kbps channel that carries signaling information or data on a <i>PRI</i> or 16-kpbs channel to carry signaling information on <i>BRI</i> .
DCP	(Digital Communications Protocol) AT&T proprietary protocol to transmit digitized voice and data over the same communications link.
dedicated feature buttons	The imprinted feature buttons on a multiline telephone: Conf or Conference , Drop , Feature , HFAI (Hands Free Answer on Intercom), Hold , Message , Mute or Microphone , Recall , Speaker or Speakerphone , and Transfer .
delay-dial-start tie trunk	See <i>dial-repeating tie trunk</i> .
DFT	(direct facility termination) See <i>personal line</i> .

DHG	(data hunt group) Group of analog or digital <i>data stations</i> that share a common access code. Calls are connected in a round-robin fashion to the first available data station in the group.
dial access	See <i>feature code</i> .
Dialed Number identification Service	See <i>DNIS</i> .
dial-out code	Digit (usually a 9) or digits dialed by telephone users to get an outside line.
dial plan	Numbering scheme for system extensions, lines, and trunks.
dial-repeating tie trunk	<i>Tie trunk</i> on which the originating end of the tie trunk transmits an off-hook signal to the receiving end and waits for the receiving end to send an off-hook signal followed by an on-hook signal. Also called "dial-repeating tie trunk."
DID	(Direct Inward Dialing) Service that transmits from the telephone company central office and routes incoming calls directly to the called extension, <i>calling group</i> , or outgoing trunk <i>pool</i> , bypassing the system operator.
DID trunk	Incoming trunk that receives dialed digits from the local exchange, allowing the system to connect directly to an extension without assistance from the system operator.
digital	Representation of information in discrete elements such as off and on or zero and one. See also <i>analog transmission</i> .
Digital Communications Protocol	See <i>DCP</i> .
digital data station	See <i>ISDN terminal adapter data station</i> .
Digital Signal 0	See <i>DS0</i> .
Digital Signal 1	See <i>DS1</i> .
digital switch element	See <i>DSE</i> .
digital transmission	Mode of transmission in which the information to be transmitted is first converted to digital form and then transmitted as a serial stream of pulses. See also <i>analog transmission</i> .
DIP switch	(dual in-line package) Switch on a 400EM module used to select the signaling format for tie-line transmission. Also used on other equipment for setting hardware options.

direct facility termination	(DFT) See <i>personal line</i> .
Direct Inward Dialing	See <i>DID</i> .
Direct-Line Console	See <i>DLC</i> .
Direct Station Selector	See <i>DSS</i> .
display buttons	Buttons on an MLX display telephone used to access the telephone's display.
DLC	(Direct-Line Console) Telephone used by a system operator to answer outside calls (not directed to an individual or a group) and inside calls, transfer calls, make outside calls for users with outward calling restrictions, set up conference calls, and monitor system operation.
DNIS	(Dialed Number Identification Service) Service provided by the AT&T Switched Network (<i>ASM</i>); it routes incoming 800 or 900 calls according to customer-selected parameters, such as area code, state, or time of call.
door answering unit	Device connected to a basic telephone jack and used at an unattended extension or front desk.
DOS	(disk operating system)
DS0	(Digital Signal 0) Single 64-kbps voice or data <i>channel</i> .
DS1	(Digital Signal 1) <i>Bit</i> -oriented signaling interface that multiplexes twenty-four 64-kbps channels into a single 1.544-Mbps stream.
DSS	(Direct Station Selector) 60-button <i>adjunct</i> that enhances the call-handling capabilities of an <i>MLX-20L</i> or <i>MLX-28D</i> telephone used as an operator console.
DTE	(data terminal equipment) Equipment that makes the endpoints in a connection over a data connection, for example, a data terminal, personal computer, host computer, or printer.
DTMF signaling	(dual-tone multifrequency signaling) Touch-tone signaling from telephones using the voice transmission path. DTMF signaling provides 12 distinct signals, each representing a dialed digit or character, and each composed of two voiceband frequencies.

E

E&M signaling	Trunk supervisory signaling, used between two communications systems, in which signaling information is transferred through two-state voltage conditions (on the Ear and Mouth leads) for analog applications and through two <i>bits</i> for digital applications. See also <i>tie trunk</i> .
EIA	(Electronic Industries Association)
EIA-232-D	Physical interface, specified by the <i>EIA</i> , that transmits and receives asynchronous data at speeds of up to 19.2-kbps over cable distances of 50 feet (15 m).
Electronic Switching System	See <i>ESS</i> .
endpoint	Final destination in the path of an electrical or telecommunications signal.
ESF	(extended superframe format) <i>Framing format</i> consisting of individual frames of 24 eight-bit slots and one signal bit (193 bits) in a 24-frame extended superframe. See also <i>D4 framing format</i> .
ESS	(Electronic Switching System) Class of central office (<i>CO</i>) switching systems developed by AT&T in which the control functions are performed principally by electronic data processors operating under the direction of a stored program.
expansion carrier	<i>Carrier</i> added to the control unit when the basic carrier cannot house all of the required modules. Houses a power supply and up to six additional modules.
ExpressRoute 1000	Data communications device that allows connection between an RS-232 <i>DTE</i> device and the control unit using MLX extension jacks on the 008 MLX or 408 GS/LS-MLX module.
extension	An endpoint on the internal side of the communications system. An extension can be a telephone with or without an adjunct. See also <i>data station</i> .
extension jack	An analog, digital, or <i>tip/ring</i> physical interface on a module in the control unit for connecting a telephone or other device to the system.

extension programming	Programming performed at an extension to customize telephones for personal needs; users can program features on buttons, set the telephone ringing pattern, and so on. See also <i>centralized telephone programming</i> and <i>system programming</i> .
extended superframe format	See <i>ESF</i> .

F

facility	Equipment (often a <i>trunk</i>) constituting a telecommunications path between the system and the telephone company central office (<i>CO</i>).
Facility Restriction Level	See <i>FRL</i> .
factory setting	Default state of a device or feature when an optional setting is not programmed by the user or system manager.
fax	(facsimile) Scanning and transmission of a graphic image over a telecommunications facility, or the resulting reproduced image, or the machine that does the scanning and transmitting.
Fax Attendant System	Fax handling and processing application available with <i>AUDIX Voice Power</i> .
FCC	(Federal Communications Commission)
feature	Function or service provided by the system.
feature code	Code entered on a dialpad to activate a feature.
feature module	Prior to Release 3.0, a circuit pack inserted into the <i>processor</i> module, used to provide system features and replaced when the system is upgraded.
Feature screen	Display screen on MLX display telephones; provides quick access to commonly used features.
ferrite core	Attachment to the AC power cord and ground wire of the carrier power supply for compliance with FCC, part 15 requirements.
Flash ROM	Beginning with Release 3.0, a type of read-only memory provided on the <i>processor module</i> , used to supply system features.

foil shield	Copper foil sheet (for power units) used to prevent excessive noise on the module.
forced idle	Condition of the system during certain programming or maintenance procedure; system prevents initiation of new calls.
foreign exchange	See <i>FX</i> .
frame	One of several segments of an analog or digital signal that has a repetitive characteristic. For example, a <i>DS1</i> frame consists of a framing <i>bit</i> and 24 bytes, which equals 193 bits.
framing format	Pattern of <i>frames</i> used in transmissions.
frequency generator	See <i>ring generator</i> .
FRL	(Facility Restriction Level) <i>ARS</i> calling restriction type that restricts outgoing calls to certain specified routes.
FX	(Foreign exchange) Central office (<i>CO</i>) other than the one that is providing local access to the public telephone network.

G

General-Purpose Adapter	See <i>GPA</i> .
glare	Condition that occurs when a user tries to call out on a <i>loop-start</i> trunk at the same time that another call arrives on the same trunk.
GPA	(General-Purpose Adapter) Device that connects an analog multiline telephone to optional equipment such as an answering machine.
ground-start trunk	Trunk on which the communications system, after verifying that the trunk is idle (no ground on tip lead), transmits a request for service (puts ground on ring lead) to the telephone company central office (<i>CO</i>).
Group IV (G4) fax machine	A fax unit, offering 400 by 100 dots per inch (DPI) in fine mode, that can operate at any speed for communication with a Group III (G3) fax machine or another Group IV (G4) fax machine.

H

Hands Free Answer on Intercom	See <i>HFAI</i> .
hands-free unit	See <i>HFU</i> .
headset	Lightweight earpiece, microphone, and adapter used for hands-free telephone operation.
HFAI	(Hands Free Answer on Intercom) Feature that allows a user to answer a voice-announced call.
HFU	(Hands-Free Unit) Unit for older analog multiline telephones that allows users to make and receive calls on the speakerphone without using the handset.
Home screen	Display normally shown on an MLX display telephone; shows time, date, and call information, and shows when some features are in use.
host	Telephone company or other switch providing features and services to the system users, usually when the system is operating in <i>Behind Switch mode</i> .
Hybrid/PBX mode	One of three modes of system operation, in which the system uses trunk <i>pools</i> and <i>ARS</i> in addition to <i>personal lines</i> . Provides a single interface (SA buttons) to users for both internal and external calling. See also <i>Behind Switch mode</i> and <i>Key mode</i> .

I

ICLID	(Incoming Call Line Identification) See <i>Caller ID</i> .
ICOM buttons	(intercom buttons) Telephone buttons that provide access to inside system lines for calling other extensions or receiving calls from them.
immediate-start tie trunk	<i>Tie trunk</i> on which no start signal is necessary; dialing can begin immediately after the trunk is seized.
in-band signaling	See <i>robbed-bit signaling</i> .
inside dial tone	A tone users hear when they are off-hook on an SA or ICOM button.
Inspect screen	Display screen on an MLX display telephone that allows the user to preview incoming calls and see a list of the features programmed on line buttons.

Integrated Administration	Capability of <i>IS III</i> that simplifies the programming of common information for the system, <i>AUDIX Voice Power</i> , and, if it is also installed, <i>Fax Attendant System</i> .
Integrated Services Digital Network	See <i>ISDN</i> .
Integrated Solution II/III	See <i>IS II/III</i> .
Integrated Voice Power Automated Attendant	<i>IS II</i> application that automatically answers incoming calls with a recorded announcement and directs callers to a department, an extension, or the system operator.
intercom buttons	See <i>ICOM buttons</i> .
interface	Hardware and/or software that links systems, programs, or devices.
I/O device	(input/output device) Equipment that can be attached to a computer internally or externally for managing a computer system's input and output of information.
IROB protector	(In-Range Out-of-Building protector) Surge-protection device for off-premises telephones at a location within 1000 feet (305 m) of cable distance from the control unit.
IS II/III	(Integrated Solution II or Integrated Solution III) Set of UNIX System-based applications that augments and provides additional services using the system.
ISDN	(Integrated Services Digital Network) Public or private network that provides end-to-end digital connectivity for all services to which users have access by a limited set of standard multipurpose user and <i>network interfaces</i> ; provides digital circuit-switched or packet-switched connections within the network and to other networks for national and international digital connectivity.
ISDN 7500B Data Module	Data communications device that allows connection between an RS-232 <i>DTE</i> device and the control unit by MLX extension jacks on the 008 MLX or 408 GS/LS-MLX module.
ISDN terminal adapter	A type of data communications equipment that transmits digital signals over digital telephone company facilities, for example, PRI. A digital data station uses an ISDN terminal adapter (such as the ExpressRoute 1000 or ISDN 7500B data module) as its DCE.

ISDN terminal adapter data station A type of data station that includes an ISDN terminal adapter as its DCE. It may also include an MLX telephone for simultaneous voice and data (ISDN terminal adapter data-only station). These data stations connect to MLX extension jack modules for digital transmission of data over a DS1 facility.

J

jack Physical connection point to the system for a telephone, trunk, or other device. Also called "port."

K

kbps Kilobits per second.

Key mode One of three modes of system operation, in which the system uses *personal lines* on line buttons for outside calls, with a separate interface (**ICOM buttons**) for internal calling. See also *Behind Switch mode* and *Hybrid/PBX mode*.

L

LAN (local area network) Arrangement of interconnected personal computers or terminals, sometimes accessing a host computer, and sometimes sharing resources like files and printers.

LDN (listed directory number)

LED (light-emitting diode) Semiconductor device that produces light when voltage is applied; light on a telephone.

line Connection between extensions within the communications system or loop-start communications path with *CO*; often, however, used synonymously with *trunk*.

line and trunk assignment Assignment of lines and trunks connected to the system control unit to specific buttons on each telephone.

line coding	Pattern that data assumes as it is transmitted over a communications channel.
line compensation	Adjustment for the amount of cable loss in decibels (dB), based on the length of cable between a 100D module and a channel service unit (<i>CSU</i>) or other far-end connection point.
line/trunk	Refers to inside system lines and outside trunks in general terms. See also <i>line</i> and <i>trunk</i> .
line/trunk jack	Physical interface on a module in the control unit for connecting an outside trunk to the communications system. Also called "trunk jack."
line/trunk and extension module	Module on which the jacks for connecting central office lines/trunks and/or the jacks for connecting the extensions are located.
local host computer access	A method for connecting an extension jack to an on-site computer for data-only calls through a <i>modem</i> or data module.
local loop	See <i>access line</i> .
logical ID	A number that is associated with each connection to the system. There is one set of logical IDs for extensions and one set for lines/trunks. Line/trunk logical IDs are numbered from 1 to 80. Extension module logical IDs are numbered from 1 to 200. For most modules there is a one-to-one correspondance between the jack and the logical ID. Exceptions are the 100D, 800 NI-BRI, and 008 OPT modules.
loop-start trunk	Trunk on which a closure between the tip and ring leads is used to originate or answer a call. High-voltage 20-Hz AC ringing current from the central office signals an incoming call.

M

Magic On Hold	An AT&T Music On Hold enhancement that promotes a company's products or services or provides custom music selection.
Mbps	(megabits per second)
Megacom	AT&T's tariffed digital <i>WATS</i> offering for outward calling.
Megacom 800	AT&T's tariffed digital 800 offering for inward calling.

memory card	Storage medium, similar in function to a floppy disk, that allows information to be added to or obtained from the communication system through the PCMCIA interface slot on the processor module.
MERLIN Identifier	Adjunct that allows users to receive, store, and use information provided by caller identification services provided by the local telephone company.
MERLIN Mail Voice Messaging System	Application that provides automated attendant, call answering, and voice-mail services on the system.
MFM	(Multi-Function Module) Adapter that has a <i>tip/ring</i> mode for answering machines, modems, fax machines, and tip/ring alerts, and an <i>SAA</i> mode for -48 VDC alerts. Installed inside an MLX telephone, and is used to connect optional equipment to the telephone. The optional equipment and the telephone operate simultaneously and independently.
MLX-10 or MLX-10D telephone	10-line button digital telephone offered with (MLX-10D) or without (MLX-10) a 2-line by 24-character display.
MLX-10DP	Same as an MLX-10D except it has an adjunct in the back for connecting the <i>PassageWay Direct Connect Solution</i> application.
MLX-20L telephone	20-line button digital telephone with a 7-line by 24-character display.
MLX-28D telephone	28-line button digital telephone with a 2-line by 24-character display.
mode codes	Streams of touch-tone codes used by voice messaging applications to communicate with the system's control unit.
modem	(modulator-demodulator) Device that converts digital data signals to analog signals for transmission over a telephone line, and analog signals received on a telephone line to digital signals.
modem data station	A type of data station that includes a modem as its DCE. It may also include an MLX telephone for simultaneous voice and data (MLX voice and modem data station), an analog multiline telephone (analog voice and modem data station), or a single-line telephone for dialing only (modem data-only station). These data stations connect respectively to MLX, analog, or tip/ring extension jack modules. They provide analog transmission of data.

modem pool	Pair, or group of pairs, of <i>modems</i> and data modules with interconnected RS-232 interfaces that converts digital signals to analog, or analog signals to digital, thereby allowing users with <i>ISDN terminal adapter data stations</i> to communicate with users who have analog <i>modem data stations</i> .
module	Circuit pack in the control unit that provides the physical jacks for connection of telephones and/or outside lines/trunks to the communications system. In the name of a module, the first digit indicates the number of <i>line/trunk jacks</i> it contains; the last digit indicates the number of <i>extension jacks</i> it contains. If no letters appear after the number, a line/trunk module provides <i>loop-start trunks</i> or an extension jack module provides analog or <i>tip/ring jacks</i> . For example, a 408 GS/LS MLX module contains four line/trunk jacks and eight digital (MLX) extension jacks, provides either loop-start (LS) or <i>ground-start (GS)trunks</i> . There are also modules for the processor and power supply.
Multi-Function Module	See <i>MFM</i> .
multiline telephone	An analog or digital (MLX) telephone that provides multiple line buttons for making or receiving calls or programming features.
multiplexing	The division of a transmission channel into two or more independent channels, either by splitting the frequency band into a number of narrower bands or by dividing the channel into successive time slots.
Music On Hold	Customer-provided music source or <i>Magic On Hold</i> connected to the system through a <i>loop-start</i> jack.

N

network	Configuration of communications devices and software connected for information interchange.
network interface	Hardware, software, or both that links two systems in an interconnected group of systems, for example, between the local telephone company and a PBX.

O

off-hook	A telephone is said to be off-hook when the user has lifted the handset, pressed the Speaker button to turn on the speakerphone, or used a headset to connect to the communications system or the telephone network.
off-premises telephone	See <i>OPT</i> .
ones density	Requirement for channelized <i>DS1</i> service to the public network that eight consecutive zeros cannot occur in a digital data stream.
on-hook	A telephone is said to be on-hook when the handset is hung up, the speakerphone is turned off, and the user is not using a headset to connect to the communications system or the telephone network.
OPT	(off-premises telephone) <i>Single-line telephone</i> or other <i>tip/ring</i> device connected to the system by an 008 OPT module in the control unit. Appears as an inside extension to the system, but may be physically located away from the system.
OPX	(off-premises extension)
out-of-band signaling	Signaling that uses the same path as voice-frequency transmission and in which the signaling is outside the band used for voice frequencies.

P

parity	The addition of a <i>bit</i> to a bit string so that the total number of ones is odd or even, used to detect and correct transmission errors.
PassageWay Direct Connect Solution	Set of software applications to provide an interface between a personal computer and the system.
pass-through	Connection from the internal <i>modem</i> to an attached IS II/IS III application on the system.
PBX	(private branch exchange) Local electronic telephone switch that serves local stations (for example, extensions within a business) and provides them with access to the public network.

PC	(personal computer)
PCMCIA memory card	(Personal Computer Memory Card International Association memory card) See <i>memory card</i> .
personal line	Central office trunk that terminates directly on one or more telephones. In <i>Hybrid/PBX mode</i> , a personal line cannot be part of a trunk <i>pool</i> . Also called "DFT" (direct facility termination). Also refers to lines represented on line buttons in <i>Key Mode</i> .
PFT	(Power-failure transfer) Feature that provides continuity of telephone service during a commercial power failure by switching some of the system's trunk connections to telephones connected to specially designated extension jacks.
pool	In <i>Hybrid/PBX mode</i> , a group of outside trunks that users can access with a Pool button or by dialing an access code on an SA button . Also used by the <i>ARS</i> feature when choosing the least expensive route for a call.
port	See <i>jack</i> . Also, refers to <i>extension</i> or <i>line jacks</i> before these are numbered according to the <i>dial plan</i> during programming. The lowest jack on a module is always Port 1.
Power Failure Transfer	See <i>PFT</i> .
power supply module	Device that directs electricity to modules and telephones on the system. One power supply module is needed for each carrier, and an <i>auxiliary power unit</i> is added if the module exceeds capacity.
PRI	(Primary Rate Interface) Standard interface that specifies the protocol used between two or more communications systems. As used in North America, provides 23 64-kbps <i>B-channels</i> for voice and/or data and one 64-kbps <i>D-channel</i> , which carries multiplexed signaling information for the other 23 channels.
primary system operator position	First jack on the first MLX or analog multiline extension module in the control unit, that is, the extension jack with the lowest <i>logical ID</i> in the system.
prime line	Individual extension number assigned to a telephone in a system operating in <i>Behind Switch mode</i> . Each telephone user has his or her own prime line and is automatically connected to that line when he or she lifts the handset.

processor module	Module in the second slot of the control unit (Slot 0, to the right of the <i>power supply module</i>). Includes the software and memory that runs the system.
programming port reassignment	Reassignment of the system programming jack position to any of the first five extension jacks on the first MLX module in the control unit.
protocol	Set of conventions governing the format and timing of message exchanges between devices, such as an MLX telephone and the control unit.
public network	Network that is commonly accessible for local or long-distance calling. Also called "public switched telephone network."

Q

QCC	(Queued Call Console) MLX-20L telephone used by a system operator in <i>Hybrid/PBX mode</i> only. Used to answer outside calls (directed to a system operator position) and inside calls, direct inside and outside calls to an extension or an outside telephone number, serve as a message center, make outside calls for users with outward calling restrictions, set up conference calls, and monitor system operation.
------------	---

R

RAM	(random-access memory) Computer memory in which an individual <i>byte</i> or range of bytes can be addressed and read or changed without affecting other parts of memory.
read-only memory	See <i>ROM</i> .
Remote Access	System feature that allows an outside caller to gain access to the system, almost as if at a system extension.
restore	Procedure whereby saved and archived system programming is reinstated on the system, from a floppy disk or <i>memory card</i> . See also <i>backup</i> .
restricted data channel	Restricted data channels do not allow the transmission of occurrences of more than seven contiguous zero bits. See also unrestricted data channel.

ring generator	Circuit pack added to the power supply that generates a high-voltage, 20–30 Hz signal to ring a telephone.
riser cable	Cable that runs between floors in a multistory building and connects wiring closets.
RS-232	Physical interface, specified by the Electronics Industries Association (<i>EIA</i>), that transmits and receives <i>asynchronous</i> data at distances of up to 50 feet (15 m).
robbed-bit signaling	Signaling in which the least significant <i>bit</i> of every sixth frame per channel is used for signaling in that channel.
ROM	(read-only memory) Computer memory that can be read but cannot be changed.

S

SAA	(Supplemental Alert Adapter) Device that permits -48-VDC alerting equipment to be connected to an analog multiline telephone jack so that people working in noisy or remote areas of a building can be alerted to incoming calls.
SA buttons	Telephone buttons that provide a single interface to users for both inside and outside calling.
SDN	(Software Defined Network) AT&T private networking service created by specialized software within the public network.
SID	(station identification)
simplex signaling	Transmission of signals in one direction only across a telecommunications channel.
signaling	Sending of control and status information between devices to set up, maintain, or cease a connection such as a telephone call.
single-line telephone	Industry-standard touch-tone or rotary-dial telephone that handles only one call at a time and is connected to the system by an <i>extension jack</i> on a basic 012, 016, or 008 OPT module.
slot	Position in a <i>carrier</i> for a module; numbered from 0 (<i>processor module</i>).
SMDR	(Station Message Detail Recording) Feature that captures detailed usage information on incoming and outgoing voice and data calls.

SMDR printer	Printer used to produce SMDR reports. Connected to the system by an RS-232 jack on the <i>processor</i> module.
Software Defined Network	See <i>SDN</i> .
special character	Pause, Stop, or End-of-Dialing signal in a programmed dialing sequence such as an Auto Dial or Personal Speed Dial number.
SPM	(System Programming and Maintenance) <i>DOS</i> - or UNIX System-based application for programming and maintaining the system.
square key	Configuration in <i>Key mode</i> operation in which all outside lines appear on all telephones.
station	See <i>extension</i> .
station jack	See <i>extension jack</i> .
Station Message Detail Recording	See <i>SMDR</i> .
Supplemental Alert Adapter	See <i>SAA</i> .
switchhook flash	Momentary (320 ms to 1 second) on-hook signal used as a control signal. May be directed either to the control unit or to a <i>host</i> switch outside the system. Also called "Recall" or "timed flash."
synchronous data transmission	Method of transmitting a continuous digital data stream in which the transmission of each binary <i>bit</i> is synchronized with a master clock. See also <i>asynchronous data transmission</i> .
system acceptance test	Test of all trunks, telephones, data terminals, and features after installation to ensure that they are working correctly.
System Access buttons	See <i>SA buttons</i> .
system date and time	Date and time that appear on MLX display telephones and <i>SMDR</i> reports.
system programming	Programming of system functions and features that affect most users, performed from an <i>MLX-20L telephone</i> or a <i>PC</i> using <i>SPM</i> . See also <i>extension programming</i> and <i>centralized telephone programming</i> .
System Programming and Maintenance	See <i>SPM</i> .

system renumbering

Procedure used to change the numbers assigned to telephones, adjuncts, *calling groups*, paging groups, park zones, *remote access*, and lines/trunks.

T

T1

Type of digital transmission facility that in North America transmits at the *DS1* rate of 1.544 Mbps.

TDM

(time-division multiplex) Process where the transmission channel is divided into time slots.

telephone power supply unit

Equipment that provides power to an individual telephone.

tie trunk

Private trunk directly connecting two telephone switches. See also *automatic-start tie trunk*, *delay-dial-start tie trunk*, *immediate-start tie trunk*, and *wink-start tie trunk*.

timed flash

See *switchhook flash*.

tip/ring

Contacts and associated conductors of a *single-line telephone* plug or jack.

touch-tone receiver

See *TTR*.

T/R

See *tip/ring*.

trunk

A telecommunications path between the communications system and the telephone company central office (*CO*) or another switch. Often used synonymously with *line*.

trunk jack

See *line/trunk jack*.

trunk pool

See *pool*.

TTR

(touch-tone receiver) Device used to decode *DTMF* touch-tones dialed from *single-line telephones* or *Remote Access telephones*.

U

uninterruptible power supply

See *UPS*.

unit load

Measure of the power load drain of a module, telephone, or *adjunct*.

unrestricted data channel	Unrestricted data channels (also called clear data channels) allow the transmission of occurrences of more than seven contiguous zero bits. If an unrestricted data channel is requested and only restricted channels are available, the call will be rejected. See also restricted data channel.
UPS	(uninterruptible power supply) Device that connects to the system to provide 117 VAC to the equipment when the commercial power source fails.

V

VAC	Alternating-current voltage.
VDC	Direct-current voltage.
VMI	(voice messaging interface) An enhanced <i>tip/ring</i> port.
voice-band channel	A transmission channel, generally in the 300–3400-Hz frequency band.
voice mail	Application that allows users to send messages to other extensions in the system, forward messages received with comments, and reply to messages.
voice messaging interface	See <i>VMI</i> .

W

WATS	(Wide Area Telecommunications Service) Service that allows calls to certain areas for a flat-rate charge based on expected usage.
wink-start tie trunk	<i>Tie trunk</i> on which the originating end transmits an off-hook signal and waits for the remote end to send back a signal (a wink) that it is ready for transmission.

Index

#

008 MLX module, 2-3
008 module, 6-3-6-4
008 OPT module
 AUDIX Voice Power, 2-26
 extension capacity, 2-3
 MERLIN MAIL voice messaging system, 2-26
012 module, 2-26
016 module, 2-4, 2-25
 ringing frequency, 2-25, 2-27
100D module, 3-3, 3-4, 3-21-3-22
2-digit numbering plan, 2-27-2-31, 2-28
3-digit numbering plan, 2-27-2-31, 2-28-2-29
408 GS/LS-MLX module, 6-3-6-4
 extension capacity, 2-3
 jacks, 3-3
 ports, 2-14-2-15
 Power Failure Transfer (PFT) feature, 2-5-2-6
408 module, 6-3-6-4
4ESS, 3-21
5ESS, 3-21
800 NI-BRI module, 2-5, 3-3, 3-5

A

Absorb digits, 4-59-4-60
Account Code Entry, 5-34, 5-37-5-38
ACCUNET Switched Digital Services, 3-4, 5-33
Adding to the system, 6-2
Adjuncts
 assigning buttons, 3-48-3-49
 features, 4-3
 jacks, 2-31, 2-22
 numbering, 2-23
 Queued Call Console (QCC), 4-3
Allowed Lists, 4-38-4-40
American Society of Composers, Artists, and Producers (ASCAP), 3-9
Analog multiline telephones
 assigning trunks, 3-47-3-48
 button assignments (Hybrid/PBX mode), 3-50-3-51
 button assignments (Key/Behind Switch mode), 3-55
 Extension Copy feature, 4-8-4-12

 features, 4-3
 jacks, 2-24-2-25
 optional features, 4-3
Analog voice and modem data stations
 lines/trunks, 5-29
 overview, 5-7
Answer supervision time, 3-37-3-38
Applications
 AT&T Attendant, 2-25
 AUDIX Voice Power/Fax Attendant, 2-25
 Integrated Solution II (IS II), 2-25
 Integrated Solution III (IS III), 2-25
 jacks, 2-25-2-27
 MERLIN MAIL voice messaging system, 2-25
 planning for, 2-12-2-13
AT&T Attendant, 2-25, 2-26, 4-26
AT&T National Technical Marketing (NTM), 3-35
AT&T Switched Network (ASN), 3-4, 5-28
AUDIX Voice Power/Fax Attendant System
 008 OPT module, 2-14-2-15, 2-26
 calling groups, 4-26-4-27, 4-29
 coverage group, 4-24-4-25
 functions, 3-10
 Integrated Administration, 2-25
 loop-start disconnect and, 3-13
 Night Service, 4-43, 4-44
 ports, 2-25-2-27
 renumbering, 2-27
 reserved extensions, 4-26
 return time interval default, 4-32
 services, 3-10
Auto Answer All, 5-34
Autodial, 3-46
Automatic backup, 2-11
Automatic Callback, 3-17, 3-18-3-19, 4-34, 5-35
Automatic Hold or Release, 4-14
Automatic Maintenance Busy, 2-10
Automatic Route Selection (ARS), 5-34-5-35
 absorb digits setting, 4-59-4-60
 area code/exchanges, 4-50-4-51
 button assignments, 3-51
 call types, 4-61
 data stations, 5-38
 description, 4-47
 Facility Restriction Levels (FRLs), 4-55-4-56
 other digits setting, 4-58-4-59
 pools, 4-55-4-56
 preferred trunk pools, 4-49
 slow dial tone and, 3-46

- subpatterns, 4-55–4-61
- tables, 4-51–4-55, 4-52, 4-61
- type of dialing, 4-48
- worksheet, 4-47–4-51

Automatic Route Selection (ARS) Tables, 4-51–4-55

Auxiliary equipment, 6-6

B

- B-channel groups, 3-30
- Backboard, 1-3
- Backing up system programming, 2-10
- Barrier codes, 3-17–3-18, 3-19
- Behind Switch mode
 - button assignments, 3-53
 - features, 2-8
- BRI line options
 - Service Profile Identifier (SPID)
 - planning form instructions, 3-42
- BRI line options planning, 3-40
 - clock synchronization
 - planning considerations, 3-43
 - Service Profile Identifier (SPID)
 - planning considerations, 3-41
 - timers
 - planning considerations, 3-44
 - planning form instructions, 3-44
- Broadcast Music Incorporated (BMI), 3-9
- Buttons
 - assigning, 3-48–3-49
 - assigning in Behind Switch mode, 3-57
 - assigning in Hybrid/PBX mode, 3-51–3-53
 - assigning in Key mode, 3-53, 3-56–3-57
 - assigning to data stations, 5-30–5-34
 - factory assignments, 3-53–3-56

C

- Call Management System (CMS), 2-20, 2-28
- Call-by-Call Service Selection, 3-4, 3-34
- Calling groups
 - AUDIX Voice Power/Fax Attendant System, 4-26–4-27, 4-29
 - calls-in-queue alarm threshold, 4-30
 - extension number, 4-26
 - Extension Status, 4-25, 4-34–4-35
 - external alert for, 4-30
 - Hunt type, 4-28
 - message-waiting receiver, 4-29

- names, 4-26
- options, 4-28–4-31
- overflow coverage, 4-30
- overflow threshold, 4-30
- overflow time threshold, 4-30
- overview, 4-25–4-28
- types, 4-30

Calling restrictions

- Automatic Route Selection (ARS), 5-38
- data stations, 5-35, 5-37
- overview, 4-4–4-5, 4-42

Calls-in-queue alarm threshold, 4-30

Calls-in-queue alert, 4-15–4-16

Camp-On, 4-33

Capacity

- extensions, 2-2–2-4
- lines/trunks, 2-2

Centralized programming, 4-2

Centrex, 3-4

Channel service unit (CSU), 3-25

Class of restriction (COR)

- with barrier codes, 3-20
- without barrier codes, 3-20

Clock synchronization

- 800 NI-BRI and 100D module interaction, 3-43
- NI-1 BRI service, 3-43
- planning considerations, 3-43
- Primary Rate Interface (PRI), 3-29–3-30
- T1 service, 3-24–3-25

Consoles, 2-11–2-12

Control unit

- backboard, 1-3
- configuration planning, 2-1
- diagram, 2-6–2-7
- environmental requirements, 1-2–1-3
- extension capacity, 2-2–2-4
- grounding requirements, 1-4–1-5
- line/trunk capacity, 2-2
- location, 1-2
- module placement, 2-1–2-2, 2-4–2-7
- operating conditions, 2-7
- outlet, 1-2
- radio frequency interference (RFI), 1-5
- space requirements, 1-3–1-4

Cover button, 4-23–4-24

Coverage

- AUDIX Voice Power/Fax Attendant System, 4-24–4-25
- Cover button, 4-23–4-24
- delay interval, 4-24
- group, 4-24–4-25
- Group Cover button, 4-25
- Group Coverage calls, 4-25

- Individual Coverage, 4-23–4-24
- overview, 4-22–4-23
- primary, 4-23
- receivers, 4-22, 4-23–4-24
- secondary, 4-23
- senders, 4-22

Coverage delay interval, 4-24

Coverage VMS, 4-9

D

Data communications

- assigning trunks, 5-25–5-30
- connectivity, 5-4–5-5
- data hunt groups (DHGs), 5-15
- data stations, 5-2
- DS1, 5-27–5-28
- extension jacks, 5-21–5-22
- features, 5-34–5-36
- ISDN terminal adapter data stations, 5-9–5-12
- LAN workstations, 5-25
- local host computer data stations, 5-23–5-24
- modem data stations, 5-6–5-9
- overview, 5-3–5-4
- planning, 5-19–5-21
- planning overview, 5-19–5-21
- terminology, 5-2–5-3

Data communications equipment (DCE)

- description, 5-3
- hardware configurations, 5-5
- ISDN terminal adapter, 5-3
- ISDN terminal adapter data stations, 5-10
- modem, 5-3
- modem data stations, 5-6

Data hunt groups (DHGs)

- configurations, 5-15–5-19
- creating, 5-39–5-42
- definition, 5-3–5-4
- modems in, 5-15–5-19
- overview, 5-15, 5-39–5-42

Data module, 5-3

Data stations

- Account Code Entry, 5-34
- analog voice and modem data, 5-7, 5-1
- Auto Answer All, 5-34
- Automatic Callback and, 5-35
- Automatic Route Selection (ARS), 5-34–5-35
- buttons in Hybrid/PBX mode, 5-30–5-32
- Call Waiting, 5-35
- calling restrictions, 5-35, 5-36

- configuration, 5-12–5-13
- configurations, 5-15–5-19
- Data Status, 5-35
- description, 5-5–5-6
- digital extension jacks, 5-22
- extension jacks for, 5-22–5-26, 5-1
- GPA, 5-1
- Idle Line Preference, 5-35
- ISDN terminal adapter data-only, 5-23
- LAN host computer, 5-23–5-24
- LAN workstations, 5-25–5-26
- Last Number Dial, 5-35
- line/trunk assignment, 5-28
- modem, 5-2, 5-5, 5-6–5-9
- modem data-only, 5-23
- off-premises modem data-only, 5-23
- personal lines, 5-35
- Personal Speed Dial, 5-35
- planning overview, 5-19–5-21
- Privacy, 5-35
- Speed dial features, 5-38–5-39
- System Speed Dial, 5-35
- Voice Announce and, 5-35

Data Status, 5-35

Data terminal equipment (DTE), 5-3

- description, 5-2–5-3
- ISDN terminal adapter data stations, 5-10
- modem data stations, 5-6
- types supported, 5-14

Date, 2-10–2-11

Delay option, 3-46

Delay Ring interval, 4-24

Dial tone, 3-37, 3-46

- secondary dial tone timer, 2-12

Dial-plan routing, 3-32

Dialed Number Identification Service (DNIS), 3-4

Digital adjuncts

- assigning buttons, 3-48–3-49
- assigning trunks, 3-48
- features, 4-3
- jacks, 2-22
- numbering, 2-30
- system numbering, 2-30
- user information, 3-48

Digital extension jacks, 5-22–5-23

Digital Signal 1 (DS1)

- assigning, 5-28
- configurations summary, 3-35
- data communications, 5-27–5-28
- data stations, 5-27–5-28
- ground-start emulation, 3-4
- T1, 6-3

Direct, 4-62
Direct Inward Dial (DID) trunks
 blocks and, 3-40
 data station configuration, 5-27
 dial one, 3-40-3-47
 disconnect time, 3-40
 expected digits, 3-39
 invalid destination, 3-40
 options, 3-38-3-39
 planning, 3-38-3-40
 remote access, 3-38
 remote access and, 3-18
 signaling, 3-39-3-40
 type, 3-39
Direct Station Selector (DSS)
 buttons for, 3-58
 park zones, 4-19-4-20
 ranges for, 4-18-4-19
Direct-Line Console (DLC)
 additional positions, 2-19-2-21
 analog optional features, 4-3
 assigning trunks, 3-47
 Automatic Hold, 4-12-4-13
 button assignment, 3-58-3-61
 button assignments, 3-58-3-61, 3-59
 definition, 2-11-2-12
 Extension Copy feature, 4-8-4-12
 factory-set button assignments, 3-58-3-61
 features, 4-12
 MFM adjuncts, 3-47
 optional features, 4-3
 primary operator position, 2-18-2-19
Directed call completion, 4-16-4-17
Disallowed Lists, 4-40-4-42
Disconnect signal, 3-12-3-13
Disconnect time, 3-38, 3-40

E

E&M signal, 3-37
Elevate priority, 4-15
Emergency Allowed List, 4-44
Employee Communications Survey, 1-7-1-8
Environmental requirements, 1-2-1-3
ExpressRoute 1000, 2-22
Extension Copy, 4-2-4-3

Extension jacks
 data stations, 5-22, 5-1
 identifying, 2-13
 LAN data stations, 5-23-5-26
 numbers, 2-4, 4-22
 pairs, 2-21-2-22
 types, 5-21
Extension Status, 4-25, 4-34-4-35
Extensions
 adding, 6-2, 6-6
 assigning numbers to, 2-13-2-14
 capacity, 2-2-2-3, 2-4
 identifying jacks, 2-14
 jack pairs, 2-21-2-22
 labels, 2-27
 module types, 2-14
 numbering plans, 2-27-2-31
 requirements and restrictions, 5-22-5-23
Extensions modules required, 6-2-6-3
External alert, 4-30

F

Facility Restriction Levels (FRLs), 4-55-4-56, 5-38
Fax machines
 features, 4-7
 Group III (G3), 5-14
 Group IV (G4), 5-14
 message threshold, 4-7
 message-waiting receiver, 4-7-4-8
Features
 adding, 6-2
 data stations, 5-34-5-36
 group-assigned, 4-20-4-21
 overview, 4-1-4-2
 system, 4-31-4-32
 telephone, 4-2-4-3
Federal Communications Commission (FCC)
 Key mode registration, 3-6
 requirements, 1-5-1-6
 system mode registration, 2-8
Floor plan, 1-9-1-10
Forced Account Code Entry, 4-8, 5-37-5-38
Forward Delay option, 4-6
Framing format, 3-23, 3-28
FTS2000 network, 3-21
Function, 3-10

G

- General-Purpose Adapter (GPA), 5-30–5-31
 - analog multiline telephone connection, 2-24
 - data stations, 5-7
 - feature assignment, 5-34
 - requirement for, 6-3–6-4
 - Ground-start emulation, 3-4
 - Ground-start trunks
 - data station assignment, 5-26–5-27
 - emulation, 3-4
 - Grounding
 - approved, 1-4
 - requirements, 1-4–1-5
 - Group Calling
 - options, 4-28–4-31
 - overview, 4-25–4-28
 - Group channel assignments, 3-31
 - Group Cover button, 4-25
 - Group Coverage, 4-24–4-25
 - Group ID, 4-22
 - Group Name, 4-22
 - Group Number, 4-21
 - Group Paging, 4-21–4-22
-

H

- Hold disconnect interval, 3-14
 - Hold return, 4-13–4-14
 - Hold timer, 4-12
 - Hunt type, 4-28
 - Hybrid/PBX mode
 - assigning buttons in, 3-48–3-53
 - Automatic Maintenance Busy, 2-10
 - buttons for data stations in, 5-1
 - calling restrictions, 4-4, 5-1
 - calling restrictions in, 4-47–4-61
 - setting up, 2-8–2-9
-

I

- Idle Line Preference, 5-35
- Integrated Administration
 - administering common entries, 2-25
 - loop-start disconnect and, 3-13
 - Night Service, 4-43, 4-44

- Integrated Solution II (IS II), 2-25
 - Integrated Solution III (IS III), 2-25
 - Integrated Voice Power Automated Attendant, 2-25
 - Intercom Ring, 5-33
 - ISDN 7500B Data Module, 2-22
 - ISDN terminal adapter data stations
 - data-only, 5-11–5-12, 5-23
 - MLX voice and ISDN terminal adapter data, 5-10–5-11
 - overview, 5-9–5-12
 - ISDN terminal adapters, 5-3
 - resource groups, 5-14
-

J

- Jacks, 3-8–3-10
 - additional operator positions, 2-19–2-21
 - analog multiline telephones, 2-24–2-25
 - applications, 2-25–2-27
 - assigning, 5-21–5-22
 - auxiliary equipment, 3-8–3-10
 - data communications, 5-21–5-22
 - data terminals, 2-22
 - extension, 2-21–2-22
 - extensions, 2-7
 - identifying for extensions, 2-14
 - lines/trunks, 3-2–3-3
 - MLX, 2-22–2-24
 - operator position maximum, 2-19–2-20
 - primary operator position, 2-18–2-19
 - system programming, 2-8
 - tip/ring (T/R) equipment, 2-25–2-27
 - type, 2-16
-

K

- Key mode
 - assigning buttons in, 3-53–3-61
 - data stations, 5-33–5-34
 - FCC registration, 3-6
 - Permanent, 2-8–2-9
 - setting up, 2-8

L

Labeling

- display telephones, 4-45
- extensions, 2-27
- Posted Messages, 4-45-4-46
- System Speed Dial, 4-46-4-47

Language selection, 2-9-2-10

Last Number Dial, 5-35

Line buttons

- assigning to data stations, 5-33
- data stations in Key mode, 5-33-5-34
- personal, 5-30-5-31
- Pool, 5-31
- SA Ring, 5-30

Line coding

- Primary Rate Interface (PRI), 3-28-3-29
- T1 service, 3-23

Line compensation

- settings, 3-24, 3-29
- T1, 3-23-3-24

Line options planning

- BRI Line Options, 3-40
 - Service Profile Identifier (SPID), 3-41
- clock synchronization, 3-43
- timers, 3-44

Lines/trunks

- adding to the system, 6-6
- assigning, 3-47-3-48, 5-32-5-33
- AUDIX Voice Power, 3-12
- capacity, 2-2
- connecting components with, 2-4
- data stations, 5-25-5-30, 5-26-5-27, 5-33
- Direct Inward Dial (DID), 3-38-3-40, 5-27
- DS1 connectivity, 3-21-3-22
- hold disconnect interval, 3-14
- identifying jacks, 3-2-3-3
- incoming types, 3-6-3-8
- jacks, 3-5-3-6
- labels, 3-7
- loop-start disconnect, 3-12-3-13
- modules and jack types, 3-3-3-4
- NI-1 BRI connectivity, 3-40
- options, 3-11-3-12
- outmode signaling, 3-13
- planning overview, 3-1
- pools, 3-15-3-17
- Primary Rate Interface (PRI), 3-21
- QCC operator to receive calls on, 3-14-3-15
- QCC queue priority, 3-15

remote access, 3-18

required, 6-2-6-3

T1 service, 3-21, 3-22-3-30

T1 Switched 56 service, 3-26

telephone planning information, 1-6-1-7

tie, 3-35-3-38

toll type, 3-13-3-14

Local Area Networks (LANs)

host computer data stations, 5-25

workstation data stations, 5-1

Local host computer data stations, 5-23-5-24

Logical IDs, 2-4

Loop-start reliable disconnect, 3-12

trunk-to-trunk transfer, 3-12

Loop-start trunks

data stations, 5-26

disconnect signal, 3-12-3-13

Loudspeaker paging jacks, 3-9

LS-ID Delay, 3-4-3-5

M

Magic on Hold, 3-9

Maintenance Alarm jacks, 3-9

Marked system speed dial, 4-46

and star codes, 2-12, 4-46

Master extensions, 4-11

Megacom 800, 3-4, 3-22

Megacom WATS, 3-4

MERLIN II

012 module, 2-26

upgrading, 7-1-7-2

MERLIN MAIL voice messaging system, 2-25, 2-26

Message center, 4-16

Message-waiting receiver, 4-29

Microphone operation, 4-5-4-6

MLX telephones

as programming equipment (MLX-20L telephone), 2-7

assigning trunks, 3-47

button assignments in Hybrid/PBX mode, 3-49-3-50

button assignments in Key/Behind Switch mode, 3-54

Extension Copy feature, 4-8-4-12

features, 4-3

jacks, 2-22-2-24

language, 2-9-2-10

MFM adjuncts, 4-3

microphone operation, 4-5-4-6

modules, 2-14-2-15

Multi-Function Module (MFM) adjuncts, 3-47

optional features, 4-2

MLX voice and ISDN terminal adapter data stations, 5-10–5-11

MLX voice and modem data stations, 5-8–5-9

MLX-20L, 2-22

Modem data stations, 5-6

- analog voice and modem data, 5-7
- data-only, 5-7–5-8
- interface, 5-6
- overview, 5-6–5-9

Modem data-only stations, 5-7–5-8, 5-23, 5-1

Modem/ISDN terminal adapter pools, 5-3

Modems

- data hunt groups (DHGs), 5-15–5-19
- description, 5-3

Modes of operation, 2-8–2-9

Modifications to system

- overview, 6-1
- preparation, 6-1–6-2

Modules

- adding to the system, 6-2–6-3
- line/trunk jack types and, 3-3–3-4
- placement in control unit, 2-1–2-2
- touch-tone receivers (TTRs), 2-16
- types, 2-1

Multi-Function Module (MFM)

- adjuncts, 3-47, 3-48
- assigning buttons, 3-48–3-49
- Behind Switch mode and, 2-22
- extension number, 2-22
- MLX telephone with, 2-24
- MLX telephones and, 3-47

MultiQuest, 3-4

Music On Hold, 3-8, 3-9

N

Network selection table, 3-33

NI-1 BRI

- connectivity, 3-40

Night Service

- AUDIX Voice Power/Fax Attendant System, 4-43, 4-44
- Emergency Allowed List, 4-44
- Exclusion List, 4-44
- group assignment, 4-42–4-43
- Integrated Administration, 4-43
- outward restriction, 4-43–4-44
- time set, 4-44–4-45

Numbering line/trunk jacks, 3-8

Numbering plans, 2-27–2-31

Numbering the system, 2-13–2-14

O

One-touch call handling, 4-32–4-33

Operator features, 4-12

Operator hold timer, 4-12, 4-17–4-18

Operator positions, 2-19–2-21

Outmode signaling, 3-13

Overflow coverage, 4-30

Overflow threshold, 4-30

Overflow time threshold, 4-30

P

Page buttons, 4-19

Park return time, 4-33–4-34

Park zones, 4-19–4-20

PC with System Programming and Maintenance (SPM), 2-7

PCMCIA card, 2-11

Permanent Key mode, 2-8–2-9

Personal lines, 4-6, 5-30–5-31, 5-35

Pickup groups, 4-21

Pool dial-out code, 3-16, 4-4, 5-36–5-37

Pools, 3-15–3-17

- assigning, 5-32–5-33
- Automatic Route Selection (ARS), 4-49, 4-55–4-56
- data stations, 5-31

Ports, 2-25–2-26

Posted Messages, 4-45–4-46

Power Failure Transfer (PFT) telephones

- jacks, 2-2
- module placement, 2-5–2-6

Pre-planning tasks

- Federal Communications Commission (FCC) requirements, 1-5–1-6
- floor plan, 1-9–1-10
- overview, 1-1

Primary operator position, 2-18–2-19

Primary Rate Interface (PRI), 3-4

- ACCUNET Switched Digital Services, 5-33
- assigning data stations, 5-28
- B-channel groups, 3-30
- Call-by-Call Service Selection, 3-34
- clock synchronization, 3-29–3-30
- dial-plan routing, 3-32
- framing format, 3-28
- incoming services, 3-32
- line appearance routing, 3-32
- line coding, 3-28–3-29

line compensation, 3-29
 network selection table, 3-33
 number to send, 3-34–3-35
 options, 3-30–3-31
 outgoing services, 3-32
 outgoing tables, 3-33
 overview, 3-27–3-28, 3-35
 review by AT&T, 3-35
 signaling mode, 3-29
 Special Services Table, 3-33–3-34
 Terminal Equipment Identifier (TEI), 3-35
 test telephone number, 3-35
 timers and counters, 3-35
 type of service, 3-28
 Principal user, 4-6–4-7
 Privacy, 5-35
 Programming
 centralized, 4-2
 equipment, 2-7
 Extension Copy feature, 4-2–4-3
 system, 4-2
 Programming equipment, 2-7

Q

Queue over threshold, 4-14–4-15
 Queued Call Console (QCC)
 additional operator positions, 2-19–2-21
 adjuncts, 4-3
 call types, 4-18
 Direct Station Selector (DSS) with, 4-16
 features, 4-3–4-4, 4-13
 identification information, 4-3
 message center, 4-16
 MFM adjunct features, 4-3
 operator to receive calls, 3-14–3-15
 optional features, 4-2
 Position Busy Backup, 4-17
 primary operator position, 2-18–2-19
 queue priority, 3-15, 4-15, 4-25
 Voice Announce, 4-18

R

Radio Frequency Interference (RFI), 1-5–1-6
 Release 1.0, 3-21, 7-1, 7-2–7-4
 Release 1.1, 3-21, 7-1, 7-2–7-4
 Release 2.0, 3-4, 3-21, 7-1, 7-2–7-4
 Release 2.1, 3-4, 7-1, 7-2–7-4

Release 3.0, 7-2–7-4
 Release 4.0
 forms, 7-4–7-6
 upgrading to, 7-1, 7-2–7-4
 Remote, 3-62
 Remote access
 barrier codes, 3-17–3-18
 dial-in tie trunks, 3-17
 Direct Inward Dial (DID) trunks, 3-17, 3-18, 3-38
 modifying, 6-3
 overview, 3-17–3-21
 shared access, 3-19–3-20
 slow dial tone and, 3-46
 Remote Call Forward, 3-46, 4-6–4-7
 forward delay option, 4-6
 Renumbering
 2-digit numbering plan, 2-27–2-28
 3-digit numbering plan, 2-28–2-29
 AUDIX Voice Power, 2-27
 overview, 2-13
 Set Up Space numbering plan, 2-30
 Reports, 2-9–2-10
 Resource groups
 definition, 5-14–5-15
 ISDN terminal adapter data-only, 5-14–5-15
 modem, 5-14
 modem-only, 5-14
 Return ring, 4-17
 Return time interval, 4-32
 Ringing frequency
 016 module, 2-25, 2-27

S

SA Ring, 5-30
 Secondary dial tone timer, 2-12
 and marked system speed dial, 2-12
 Service Profile Identifier (SPID)
 planning considerations, 3-41
 planning form instructions, 3-42
 Set Up Space numbering plan, 2-27, 2-30
 Shared Access for Switched Services (SASS), 3-4
 Signaling
 Direct Inward Dial (DID) trunks, 3-39–3-40
 Primary Rate Interface (PRI), 3-29
 tie trunks, 3-36–3-37
 Signaling mode
 information, 3-31
 T1 service, 3-23
 Simultaneous voice and data, 2-21–2-22

- Slow dial tone, 3-46–3-47
- Software Defined Network (SDN), 3-4
- Space requirements, 1-3
- Speakerphone, 2-24
- Special Services Table, 3-33–3-34
- Speed dial
 - marked system, 4-46
 - marked system and star codes, 2-12, 4-46
 - system, 4-46
- Station Message Detail Recording (SMDR)
 - language, 2-9–2-10
 - options, 4-35–4-36
- Subpatterns, 4-55–4-58
- Supplemental Alert Adapter (SAA), 2-22, 2-23
- Surge protection, 1-4–1-5
- Switchhook flash, 3-4
- System
 - adding to, 6-2
 - consoles, 2-7
 - date, 2-10–2-11
 - extension capacity, 2-2–2-4
 - lines/trunks capacity, 2-2
 - modes of operation, 2-8–2-9
 - operating conditions, 2-7
 - time, 2-10–2-11
- System adjuncts, 3-9
- System components, 1-1
- System consoles, 2-11–2-12
- System features
 - Automatic Callback interval, 4-34
 - Camp-On return time, 4-33
 - one-touch call handling, 4-32–4-33
 - overview, 4-31–4-32
 - Park return time), 4-33–4-34
 - return time interval, 4-32
 - transfer audible, 4-33
 - transfer options, 4-32–4-33
- System forms, 7-4–7-6
- System modifications, 6-1
- System numbering
 - adjuncts, 2-23
 - digital adjuncts, 2-30
 - extension jacks, 2-14
 - line/trunk jacks, 3-2
 - overview, 2-13–2-14
 - plans, 2-27–2-31
 - renumbering, 2-27–2-31
- System programming, 4-2
- System Programming and Maintenance (SPM)
 - console, 2-7
 - programming compatibility, 7-3
 - software, 2-7–2-8

- System Speed Dial, 5-35
 - codes, 5-38–5-39
 - labels, 4-46–4-47
- System speed dial, 4-46

T

- T1 service
 - channel service unit (CSU), 3-25
 - clock synchronization, 3-24–3-25
 - common services, 3-4
 - digital data transmission, 3-22
 - DS1 connectivity, 6-3
 - framing format, 3-23
 - line compensation, 3-23–3-24
 - line coding, 3-23
 - overview, 3-22–3-30
 - signaling mode, 3-23
 - T1/PRI review, 3-35
 - type of service, 3-23
- T1 Switched 56 service, 3-3, 3-22
 - clock synchronization, 3-24
 - dial plan routing, 3-26
 - direction, 3-27
 - framing format, 3-23
 - incoming signaling mode, 3-27
 - incoming signaling type, 3-26
 - line appearance routing, 3-26
 - line coding, 3-23
 - line compensation, 3-23
 - outgoing signaling mode, 3-27
 - outgoing signaling type, 3-27
 - overview, 3-26
 - signaling mode, 3-23
 - type of service, 3-23
- Telephone buttons
 - assigning, 3-48
 - Direct-Line Console (DLC), 3-58–3-61
 - Hybrid/PBX mode, 3-48–3-49
 - Key and Behind Switch mode, 3-53–3-61
- Telephone company information, 1-6–1-7
- Telephone number, 3-7
- Terminal adapters, 2-22
- Terminal Equipment Identifier (TEI), 3-35
- Test telephone number, 3-32, 3-35
- Tie trunks, 3-35–3-38
 - barrier codes, 3-18
 - data station assignment, 5-27
 - dial tone, 3-37
 - options, 3-35–3-36

- overview, 3-35–3-38
- remote access and, 3-17
- signaling, 3-36–3-37
- slow dial tone and, 3-46

Time, 2-10–2-11

Timers

- planning considerations, 3-44
- planning form instructions, 3-44
- secondary dial tone, 2-12

Timers and counters, 3-35

Tip/ring (T/R) equipment, 6-3

- assigning trunks, 3-47
- data stations, 5-6
- features, 4-3
- jacks, 2-25–2-27
- MLX telephones, 2-22
- optional features, 4-3

Tip/ring equipment, 6-3–6-4

Toll abuse, 3-38

Toll type, 3-13–3-14

Touch-tone receivers (TTRs)

- modules with, 2-16
- overview, 2-16–2-18
- system requirements, 2-17
- voice messaging system requirement, 2-17

Transfer audible, 4-33

Trunk-to-Trunk Transfer, 4-8

Trunk-to-trunk transfer, 3-12

W

Warranty, 7-1

U

UNIX System, 7-2

Upgrading

- compatibility, 7-3–7-4
- overview, 7-1–7-6

User information, 1-7–1-8

V

Video communications

- connectivity, 5-4
- group video, 5-17
- overview, 5-15
- personal video, 5-16
- terminology, 5-3

Video endpoints, 2-3

Voice Announce to Busy, 2-21, 6-3

Voice messaging systems, 2-17