

**Lucent Technologies**  
Bell Labs Innovations



**MERLIN LEGEND®**  
**Communications System**  
**Release 6.1**

Network Reference

555-661-150  
Comcode 108289703  
Issue 1  
August 1998

#### Notice

Every effort was made to ensure that the information in this book was complete and accurate at the time of printing. However, information is subject to change. See Appendix A, “*Customer Support Information*,” for important information.

#### Your Responsibility for Your System’s Security

Toll fraud is the unauthorized use of your telecommunications system by an unauthorized party, for example, persons other than your company’s employees, agents, subcontractors, or persons working on your company’s behalf. Note that there may be a risk of toll fraud associated with your telecommunications system, and if toll fraud occurs, it can result in substantial additional charges for your telecommunications services.

You and your System Manager are responsible for the security of your system, such as programming and configuring your equipment to prevent unauthorized use. The System Manager is also responsible for reading all installation, instruction, and system programming documents provided with this product in order to fully understand the features that can introduce risk of toll fraud and the steps that can be taken to reduce that risk.

Lucent Technologies does not warrant that this product is immune from or will prevent unauthorized use of common-carrier telecommunication services or facilities accessed through or connected to it. Lucent Technologies will not be responsible for any charges that result from such unauthorized use. For important information regarding your system and toll fraud, see Appendix A, “*Customer Support Information*.”

#### Federal Communications Commission Statement

This equipment has been tested and found to comply with the limits for a Class A digital device, pursuant to Part 15 of the FCC Rules. These limits are designed to provide reasonable protection against harmful interference when the equipment is operated in a commercial environment. This equipment generates, uses, and can radiate radio frequency energy and, if not installed and used in accordance with the instruction manual, may cause harmful interference to radio communications. Operation of this equipment in a residential area is likely to cause harmful interference, in which case the user will be required to correct the interference at his own expense. For further FCC information, see Appendix A, “*Customer Support Information*.”

#### Canadian Department of Communications (DOC) Interference Information

This digital apparatus does not exceed the Class A limits for radio noise emissions set out in the radio interference regulations of the Canadian Department of Communications.

Le Présent Appareil Numérique n’émets pas de bruits radioélectriques dépassant les limites applicables aux appareils numériques de la classe A prescrites dans le règlement sur le brouillage radioélectrique édicté par le ministère des Communications du Canada.

#### Trademarks

DEFINITY, HackerTracker, MLX-5, MLX-5D, MLX-10, MLX-10D, MLX-10DP, MLX-16DP, MLX-20L, MLX-28D, and PassageWay, are registered trademarks and Lucent Technologies is a trademark of Lucent Technologies in the US and other countries. NetPROTECT is a service mark of Lucent Technologies in the US and other countries.

Novell and NetWare are registered trademarks of Novell, Inc.

#### Ordering Information

**Call:** BCS Publications Center  
Voice 1 800 457-1235 International Voice 317-322-6791  
Fax 1 800 457-1764 International Fax 317-322-6699

**Write:** BCS Publications Center  
2855 North Franklin Road  
Indianapolis, IN 46219-1385

**Order:** Document No. Lucent Technologies 555-661-150  
Comcode: 108289703  
Issue 1, August 1998

For more information about Lucent Technologies documents, refer to the section entitled, “*Related Documents*”.

#### Support Telephone Number

In the continental US, Lucent Technologies provides a toll-free customer helpline 24 hours a day. Call the Lucent Technologies Helpline at **1 800 628-2888** or your Lucent Technologies authorized dealer if you need assistance when installing, programming, or using your system. Consultation charges may apply. Outside the continental US, contact your local Lucent Technologies authorized representative.

#### Lucent Technologies Fraud Intervention

If you *suspect you are being victimized* by toll fraud and you need technical support or assistance, call Lucent Technologies National Customer Care Center at **1 800 628-2888**.

#### Warranty

Lucent Technologies provides a limited warranty on this product. Refer to “*Limited Warranty and Limitation of Liability*” in Appendix A, “*Customer Support Information*.”

# Contents

---

## **New Features and Enhancements** xv

- Release 6.1 Enhancements xv  
(August 1998)

---

## **Prior Releases: Features and Enhancements** xix

- Release 6.0 Enhancements xix  
(February, 1998)

---

## **IMPORTANT SAFETY INSTRUCTIONS** xxv

---

## **About This Book** xxvii

- Intended Audience xxvii
- How to Use This Book xxviii
- Terms and Conventions Used xxviii
- Security xxx
- Related Documents xxx
- How to Comment on This Book xxxii

---

## **1 Introduction** 1-1

- Networking Concepts 1-2
- Tandem Trunking and Tandem Switching 1-6
- Uniform Dial Plan 1-19
- Centralized Voice Messaging System 1-21

---

<b>2</b>	<b>Call-Handling Scenarios</b>	2-1
	■ Networking Guidelines	2-2
	■ Network Configuration Scenarios	2-14

---

<b>3</b>	<b>Feature Interactions</b>	3-1
	■ Account Code Entry	3-1
	■ Alarm	3-1
	■ Allowed/Disallowed Lists	3-2
	■ Authorization Code	3-2
	■ Auto Answer All	3-2
	■ Auto Answer Intercom	3-2
	■ Auto Dial	3-2
	■ Automatic Route Selection (ARS)	3-3
	■ Barge-In	3-4
	■ Callback	3-4
	■ Caller ID	3-5
	■ Calling Restrictions	3-5
	■ Camp-On	3-6
	■ Centralized Voice Messaging (Release 6.1 and Later Systems)	3-6
	■ Computer Telephony Integration (CTI) Link	3-7
	■ Conference	3-8
	■ Coverage	3-9
	■ Digital Data Calls	3-9
	■ Direct-Line Console (DLC)	3-10
	■ Direct Station Selector (DSS)	3-10
	■ Direct Voice Mail	3-10
	■ Directories	3-10
	■ Display	3-11
	■ Do Not Disturb	3-12
	■ Extended Station Status	3-12
	■ Forward and Follow Me	3-13
	■ Group Calling	3-13
	■ Hands Free Answer on Intercom (HFAI)	3-15

■ HotLine	3-16
■ Labeling	3-16
■ Messaging	3-16
■ Music On Hold	3-17
■ Night Service	3-17
■ Paging	3-17
■ Park	3-18
■ Personal Lines	3-18
■ Pickup	3-18
■ Pools	3-18
■ Primary Rate Interface (PRI) and T1	3-19
■ Queued Call Console (QCC)	3-20
■ Reminder Service	3-20
■ Remote Access	3-21
■ Service Observing	3-22
■ Signal/Notify	3-22
■ Station Message Detail Recording (SMDR)	3-23
■ Speed Dial	3-25
■ System Renumbering	3-26
■ Transfer	3-26
■ Voice Announce to Busy	3-27
■ Voice Messaging Interface (VMI)	3-27

---

<b>4</b>	<b>Security</b>	4-1
	■ Overview	4-2
	■ Facility Restriction Levels and Remote Access	4-5

---

<b>5</b>	<b>Network Management</b>	5-1
	■ General Programming in Private Networks	5-2
	■ Non-Local Dial Plan Numbering	5-15
	■ Switch Identifiers	5-19
	■ Tandem PRI Facilities	5-22
	■ Uniform Dial Plan Routing	5-25

- Display Preferences for Intersystem Calls 5–31

---

<b>6</b>	<b>Troubleshooting</b>	6–1
	■ Troubleshooting Guidelines and Preparation	6–2
	■ Verifying Switch Identifiers	6–4
	■ Call to a Non-Local Extension: Unexpected Busy Tone	6–5
	■ Call to Non-Local Extension: Silence or Fast Busy Tone	6–6
	■ Call to Non-Local Extension: Warble Tone (Error Tone)	6–11
	■ Calls to Non-Local Extensions: Unexpected Busy Tone	6–13
	■ Call to Non-Local Extension Reaches Wrong Extension	6–14
	■ Call to Non-Local Extension: Message from CO	6–15
	■ Transfer to Non-Local Extension Not Completed	6–15
	■ Transfer Call to Non-Local Extension Does Not Return	6–16
	■ Conference: Cannot Add Call	6–17
	■ DID Calls Not Completed	6–17
	■ ARS Calls Are Blocked	6–19
	■ Callback Does Not Work	6–20
	■ Network Call Transmission Level (Volume) Too Low or Too High	6–20
	■ MLX Displays: Network Call Display Problems	6–22
	■ PassageWay Call Display Problems	6–23
	■ ARS Calls Go to System Operator (Unassigned Extension)	6–24
	■ DID or PRI Dial-Plan Routed Calls Not Completed	6–24
	■ Excessive Line Noise on Voice and Data Calls	6–25
	■ Station Message Detail Recording (SMDR) Reports Do Not Include Calls across the Network	6–25
	■ Operator Hears Tones	6–26
	■ Calls From a Remote System Do Not Reach the Centralized Voice Messaging System	6–26
	■ Calls From a Remote System to Centralized Voice Messaging System Get the Wrong Message or Go To Operator	6–29
	■ No Message Waiting Light Update	6–30

---

<b>A</b>	<b>Customer Support Information</b>	A-1
	■ Support Telephone Number	A-1
	■ Federal Communications Commission (FCC) Electromagnetic Interference Information	A-1
	■ Canadian Department of Communications (DOC) Interference Information	A-2
	■ FCC Notification and Repair Information	A-2
	■ Installation and Operational Procedures	A-4
	■ DOC Notification and Repair Information	A-5
	■ Renseignements sur la notification du ministère des Communications du Canada et la réparation	A-6
	■ Security of Your System: Preventing Toll Fraud	A-9
	■ Toll Fraud Prevention	A-10
	■ Other Security Hints	A-16
	■ Limited Warranty and Limitation of Liability	A-20
	■ Remote Administration and Maintenance	A-21

---

<b>B</b>	<b>Sample Reports</b>	B-1
	■ Dial Plan Report	B-6
	■ Non-Local Dial Plan Report	B-9
	■ Tie Trunk Information Report	B-10
	■ DID Trunk Information Report	B-11
	■ General Trunk Information Report	B-12
	■ DS1 Information Report	B-13
	■ PRI Information Report	B-14
	■ Remote Access (DISA) Information Report	B-18
	■ Disallowed Lists Report	B-19
	■ Access to Disallowed Lists Report	B-19
	■ Automatic Route Selection Report	B-20
	■ Extension Directory Report	B-21
	■ Extension Information Report	B-22
	■ Direct Group Calling Information Report (Local Members Only)	B-24

- Direct Group Calling Information Report (Single Non-Local Member) B-25
- Error Log Report B-26
- Switch 56 Data Information Report B-27

---

<b>C</b>	<b>Voice/Fax Messaging Systems</b>	C-1
	■ Supported System Considerations	C-2
	■ Fax Messaging in a Centralized Voice Mail Configuration	C-4

---

<b>D</b>	<b>Touch-Tone Receiver Requirements</b>	D-1
	■ System Requirements for Touch-Tone Receivers	D-1

---

<b>GL</b>	<b>Glossary</b>	GL-1
-----------	-----------------	------

---

<b>IN</b>	<b>Index</b>	IN-1
-----------	--------------	------



# Figures

---

<b>1</b>	<b>Introduction</b>	1-1
1-1	Series Configuration	1-7
1-2	Star Configuration: Five Systems	1-8
1-3	Star Configuration: Three Systems	1-9
1-4	Series Configuration: Four Systems	1-13
1-5	Star Configuration: Three Systems	1-14
1-6	Star Configuration: Five Systems	1-16
1-7	Software Defined Network (SDN) Configuration	1-17
1-8	Uniform Dial Plans	1-20
1-9	Centralized Voice Mail with one VMS/AA for Entire Network	1-24
1-10	Networked Voice Mail Systems	1-26

---

<b>2</b>	<b>Call-Handling Scenarios</b>	2-1
2-1	Scenario 1: Overview	2-17
2-2	Scenario 2: Company Floor Plans	2-33
2-3	Scenario 2: Overview	2-45
2-4	Scenario 3: Overview	2-58
2-5	Scenario 4: Overview	2-75
2-6	Scenario 5: Overview	2-89

---

<b>3</b>	<b>Feature Interactions</b>	3-1
3-1	UDP Calls Recorded at All Systems	3-24
3-2	No UDP Calls Recorded at All Systems	3-25

---

<b>4</b>	<b>Security</b>	4-1
4-1	Facility Restriction Levels Applied to Network Calls	4-10



# Tables

---

<b>1</b>	<b>Introduction</b>	1-1
	1-1 Tandem PRI Trunks versus Tandem Tie Trunks	1-11

---

<b>2</b>	<b>Call-Handling Scenarios</b>	2-1
	2-1 UDP Extension Ranges: Scenario 1	2-22
	2-2 Scenario 1: Facilities Planning, Calls Originating within the private network and Going to the PSTN	2-24
	2-3 Scenario 1: ARS Routing Summary, Calls Originating within the private network and Going to the PSTN	2-25
	2-4 Outside Calls: Scenario 1	2-27
	2-5 Intersystem Calling: Scenario 1	2-30
	2-6 Work Group Needs	2-36
	2-7 Individual Needs	2-38
	2-8 UDP Extension Ranges: Scenario 2	2-48
	2-9 Scenario 2: Facilities Planning, Calls Originating within the private network and Going to the PSTN	2-49
	2-10 Scenario 2: ARS Routing Summary, Calls Originating within the private network and Going to the PSTN	2-50
	2-11 Outside Calls: Scenario 2	2-52
	2-12 Intersystem Calling: Scenario 2	2-55
	2-13 UDP Extension Ranges: Scenario 3	2-61
	2-14 Scenario 3: Facilities Planning, Calls Originating within the private network and Going to the PSTN	2-63
	2-15 Scenario 3 ARS Routing Summary: Calls Originating within the Network and Going to the PSTN: Systems J & K	2-65
	2-16 Scenario 3 ARS Routing Summary: Calls Originating within the Network and Going to the PSTN: Systems L & M	2-66
	2-17 Outside Calls: Scenario 3	2-68
	2-18 Intersystem Calling: Scenario 3	2-71
	2-19 UDP Extension Ranges: Scenario 4	2-79

2-20	Scenario 4: Facilities Planning, Calls Originating within the Network and Going to the PSTN, Systems E and H	2-82
2-21	Scenario 4: Facilities Planning, Calls Originating within the Network and Going to the PSTN, Systems F and G	2-84
2-22	Outside Calls: Scenario 4	2-86
2-23	UDP Extension Ranges: Scenario 5	2-92
2-24	Scenario 5: Facilities Planning, Calls Originating within the Private Network and Going to the PSTN	2-93
2-25	Outside Calls: Scenario 5	2-95
2-26	Intersystem Calling: Scenario 5	2-97

---

<b>3</b>	<b>Feature Interactions</b>	3-1
3-1	Cross-Network Display Information	3-15

---

<b>4</b>	<b>Security</b>	4-1
4-1	Calling Restrictions and Security Feature Planning in Networks	4-3
4-2	Recommended Settings for Tie and Non-Tie Default COR and Callback	4-9
4-3	Facility Restriction Levels	4-11

---

<b>5</b>	<b>Network Management</b>	5-1
5-1	Cross-Network Display Information	5-11

---

<b>B</b>	<b>Sample Reports</b>	B-1
B-1	Sample Report Pages	B-1
B-2	System Reports	B-2

---

<b>D</b>	<b>Touch-Tone Receiver Requirements</b>	D-1
D-1	TTRs Required by VMS/AA	D-2
D-2	System Requirement for TTRs	D-3
D-3	TTRs Required for Primary Delay Announcement Devices When Using Prompt-Based Overflow	D-3
D-4	TTRs Required for Secondary Delay Announcement Devices When Using Prompt-Based Overflow	D-4
D-5	Modules with TTRs	D-4



# **New Features and Enhancements**

---

## **Release 6.1 Enhancements (August 1998)**

---

Release 6.1 includes all Release 6.0 functionality, plus the enhancements listed below.

### **Private Networking**

---

Release 6.1 enhances the functioning of the networked MERLIN LEGEND Communications System in a number of ways:

- Centralized Voice Messaging
- Group Calling Enhancements
- Transfer Redirect
- Direct Station Selector
- Call Forwarding
- SMDR
- Decrease in Call Set-Up Time
- PRI Switch Type Test

## Centralized Voice Messaging

One or more MERLIN LEGEND systems (Release 6.1 or later) can share the voice messaging system (VMS) of another MERLIN LEGEND system, provided the systems are directly connected to the system with the VMS. In this configuration, the system containing the VMS is known as the hub. This sharing of the VMS is called "Centralized Voice Messaging." Centralized Voice Messaging includes the functions of voice mail, Automated Attendant, and fax messaging. See the *Network Reference* for detailed information about Centralized Voice Messaging.

Centralized Voice Messaging offers the following benefits:

- Private-networked MERLIN LEGEND systems do not need a local VMS. Having systems use a centralized VMS instead of separate VMS's is more economical.
- Users that travel between sites can dial the same digits anywhere in the private network to access the voice messaging system. For example, a salesperson headquartered in Cincinnati can dial the same four digits at the company's Los Angeles office to retrieve voice messages.
- Productivity is enhanced because messages can be forwarded and broadcasted to all personnel within the private network.
- Calling groups on networked systems can send overflow coverage to a shared VMS, so that an incoming caller can leave a message instead of waiting in a queue.
- The VMS can light the Message Waiting lights on multiple MERLIN LEGEND systems in a private network. This greater efficiency saves time because a user only has to look at his or her telephone to determine if he or she has a message.

## Group Calling Enhancements

A calling group can have a *single* non-local member that is defined by the Uniform Dial Plan and exists on another MERLIN LEGEND Communications System connected by a tandem trunk to the local system. If a calling group contains a non-local member, the non-local member must be the *only* member in the calling group. See the *Network Reference* for details.

A calling group containing a single non-local member can be used for the same purposes as a calling group containing local extensions, including:

- **Night Service.** Night Service coverage can be provided across a private network to a centralized Automated Attendant, a non-local calling group, a QCC queue, a DLC, or any individual extension on the remote system, such as a night bell.
- **Group Coverage.** Group Coverage can be provided across a private network to a VMS, a non-local calling group, a QCC queue, a DLC, or any individual extension on the remote system.



- **Calling group overflow coverage.** Calling group overflow coverage can be provided by a centralized VMS, a non-local calling group, a QCC queue, a DLC, or any individual extension on the remote system.
- **Calls directed to another system.** Lines connected to remote systems can be answered by any extension programmed to answer the call, such as a centralized Automated Attendant or a system operator (QCC or DLC).

## Transfer Redirect

When an Automated Attendant transfers a call to a non-local extension, the transferring MERLIN LEGEND system monitors the call to ensure that it is answered. If the non-local extension is not available or the call is not answered within the transfer redirect timeout period (fixed at 32 seconds), the call stops ringing at the non-local destination and is redirected to the extension on the same system as the Automated Attendant that is programmed to receive redirected calls. This redirect extension can be a QCC queue, a calling group, or an individual extension.

## Direct Station Selector

Now users can press a Direct Station Selector (DSS) button for a non-local extension to make or transfer calls to that extension. However, no busy indication is displayed by the DSS for non-local extensions.

## Call Forwarding

The Forward feature now can be used to send calls to non-local extensions across the private network.

## SMDR

In addition to SMDR options for non-network calls placed to and from the local system, system managers now can program SMDR to log incoming and outgoing UDP calls, or they can choose to log no UDP calls. The factory setting is to record all UDP calls.

Customers who use a call accounting system may not want to fill the database with calls coming and going across the private network. These customers may choose not to log UDP calls.

## Decrease in Call Set-Up Time

The set-up time for a call across a private network has been reduced by programming the number of UDP digits expected.

## **PRI Switch Type Test**

A new maintenance test, the PRI Switch Type Test, has been created to allow Lucent Technologies technicians or authorized dealers to automatically determine if each end of the PRI tandem trunks has been programmed correctly.

## **Service Observing**

---

Service Observing allows one extension to listen in on (observe) a call at another extension. A typical application of this feature is that of a Customer Service supervisor observing how a Customer Service representative handles calls.

The Service Observing group can consist of from one extension to all extensions in the system, including other Service Observers. Up to 16 Service Observing groups can be programmed. The Service Observer and the observed extension must be on the same system.

The observer activates Service Observing either by pressing a Service Observing button and then dialing an extension number or by pressing a DSS or Auto Intercom button. The Service Observer must use an MLX telephone to observe an extension; the telephone at the observed extension can be of any type.

A warning tone that alerts the observer, the observed extension, and the caller that Service Observing is occurring can be set to On or Off through System Programming. The factory setting is On.

## **Win SPM**

---

The System Programming and Maintenance (SPM) software is now available in a Windows format called *Win SPM*. For Release 6.1 and later systems, Win SPM provides a graphical user interface (GUI) for those tasks most commonly performed by the system manager. Pictorial representations of system components, such as modules and their vintages and the creation of MLX telephone button labels, appear on Win SPM. Win SPM also provides a DOS-emulator mode to program tasks not currently supported by the GUI and to program a MERLIN LEGEND system of Release 6.0 or earlier. Win SPM is available on CD-ROM and is supported in Windows 95, Windows NT, and Windows 98.

## **Windows NT Driver**

---

Now available is the MERLIN LEGEND Windows NT PBX driver. When coupled with the CentreVU Telephony Services application, the driver provides true server-based Computer Telephony Integration (CTI). The new driver requires a MERLIN LEGEND system of Release 5.0 or later and servers and PCs that support the applications.

## Prior Releases: Features and Enhancements

---

### Release 6.0 Enhancements (February, 1998)

---

Release 6.0 includes all Release 5.0 functionality, plus the enhancements listed below.

#### Private Networks

---

In Hybrid/PBX mode systems only, MERLIN LEGEND Communications Systems can be networked with one another or with DEFINITY<sup>®</sup> Enterprise Communications Server (ECS) and ProLogix<sup>™</sup> Communications Systems in private networks. In previous releases, this functionality is available using tie lines, but users handle calls between networked switches as outside calls. In this release, dialing the pool access code is not necessary for a call going from one networked switch to another. Also, delay-start tie trunks or T1 trunks administered as PRI can act as *tandem trunks* to connect networked systems.

Available for Hybrid/PBX mode systems, the private network features of the MERLIN LEGEND Communications System Release 6.0 provide the following advantages for geographically dispersed organizational sites:

- **Intersystem Calling.** In a private network, users on one local system can call extensions on other systems in the network. Release 6.0 can support 2-, 3-, 4-, or 5-digit dial plans. They dial these extensions as inside calls. To implement this function, the system manager programs the extension ranges of remote networked switches to create a non-local dial plan. This programming does not actually affect numbering on the remote system. To correctly set up systems for transparent calling among non-local dial plan extensions, the system manager assigns networking tie and/or PRI tandem trunks to pools. Then he or she programs as many as 20 patterns,

associates with routes, Facility Restriction Levels (FRLs), digit absorption, and digit prepending. This allows ARS-like routing of non-local dial plan calls. In addition, system managers can control whether calling name, calling number, or both are shown at MLX display telephone for incoming calls across PRI tandem trunks.

- **Toll Savings.** Private networked trunks may allow you to realize significant cost savings on long-distance and toll calls by performing tandem switching in the following two ways:
  - Callers on a local system, or individuals dialing in to remote access at a local system, can reach the public switched telephone network (PSTN) via outside trunks connected to other systems in a private network, avoiding toll charges or decreasing the cost of toll calls. No special dialing is required. For example, an organization might have a main office in Boston and a subsidiary office in New Jersey, connected by networked private tandem trunks between two systems. A user in the New Jersey office who wishes to make an outside call to the 617 area code (Boston) can do so through a line/trunk connected to the system in Boston. For example, he or she might dial, *916175551211*. The local ARS tables would route this call over the private network trunks and use the ARS tables of the remote system in Boston to route this call. The system managers at each end of a private network set up ARS and Remote Access features to implement this functionality.
  - In addition, local organizations or incoming DID calls use private networked trunks to make intersystem calls between networked systems, which may be geographically distant from one another, also resulting in toll savings.
- **Service Cost Savings.** In addition to toll call saving, there are two ways that organizations can save on service costs incurred from telecommunications providers that provide public switched telephone network access:
  - You order a point to point T1 facility from a service provider, then use system programming to set it up for PRI signalling. As necessary, a service provider can provide amplification on the T1 facility, but does not supply switching services.
  - You can tailor your use of PRI B-channels with drop-and-insert equipment that allows fractional use of B-channels for dedicated data/video communications between systems at speeds greater than 64kbps per channel or 128 kbps for 2B data, while keeping the remaining B-channels for PRI voice traffic. The PRI D-channel must remain active.
  - You can tailor use of T1 channels to support both T1-emulated tandem tie service and T1 Switched 56 service for data communications at 56 kbps per channel, allowing 2B data transfers at 112 kbps. You can also use drop-and-insert equipment to provide fractional T1 use.

- **Voice Mail and Auto Attendant.** Networked systems should have their own local voice mail and/or auto attendant applications as well as their own external alerts and Music On Hold sources. However, a single auto attendant can transfer calls throughout the network. It can answer only those calls that arrive on the PSTN facilities of the system where it is connected.

Although many features are available using tie trunks for network connectivity, PRI tandem trunks provide greatly enhanced features and faster call setup. For this reason, PRI is recommended over tie functionality in private networks.

## Group Calling Enhancements

---

Release 6.0 and later systems include Group Calling features that enhance group calling operations.

## Queue Control

The system manager can control the maximum number of calls allowed in the primary calling group queue for calls that arrive on certain facilities often assigned to calling groups. When the number of the calls in queue reaches the programmed maximum, subsequent callers receive a busy signal.

Queue control applies to calls received on the following types of facilities:

- DID (Direct Inward Dialing)
- PRI facilities programmed for dial-plan routing
- All calls transferred from a VMI (voice messaging interface) port
- Dial-in Tie

Queue control also applies to internal calls to a calling group and calls to a calling group through the QCC.

Internal calls that dial #0 or #800 and are directed to a calling group administered as Position-Busy Backup are eligible for queue control. Calls that come in on a trunk assigned to the Queued Call Console (QCC) are not eligible for queue control if the call is directed to a calling group designated as Position-Busy Backup.

Remote-access calls to a calling group, coverage calls directed to a calling group, calls directed to calling group through QCC Position-Busy backup, and all other outside calls are not eligible for queue control.

## Prompt-Based Overflow

System managers can activate the Prompt-Based Overflow option. This option allows callers waiting in queue and listening to a delay announcement to press the # key in order to reach the overflow receiver for the group, which may be the QCC queue or another calling group (including a calling group assigned for a voice mail system).

All three overflow distribution options—based on the number of calls, the time a caller has waited, and according to the caller's prompt—may be used at one time. In this case, time-based and number-of-calls based options take precedence over overflow distribution based on the caller's prompt.

When prompt-based overflow distribution is used, an extra TTR must be provided for each delay announcement device assigned to the associated calling group. The delay announcement informs the caller of the # key option to exit the queue and leave rather than waiting for an agent. If no TTR is available when a calling group call arrives, the call is not sent to a delay announcement extension.

## Centrex Transfer via Remote Call Forwarding

---

Centrex Transfer via Remote Call Forwarding can be used in all system modes of operation to send outside calls to a remote telephone number or another Centrex station. In this context, the term *outside calls* refers to calls from outside the communications system, which may originate at extensions in the Centrex system but not connected to the local MERLIN LEGEND Communications System.

An outside call that uses this feature is defined as a call that arrives on an analog Centrex loop-start line at the MERLIN LEGEND Communications System. It may arrive directly or be transferred without consultation or without transfer supervision (in the case of an automated attendant). The forwarding call to the outside number is made on the same line/trunk on which the call arrived, conserving system facilities. The following considerations and rules apply:

- Only outside Centrex calls are forwarded using this feature.
- The system must be equipped with analog loop-start Centrex lines and all loop-start lines in the system must be Centrex facilities. Loop-start lines do not have to provide reliable disconnect for use by the Centrex Transfer via Remote Call Forwarding feature.
- To transfer calls outside the Centrex system, the organization must subscribe to a Centrex trunk-to-trunk transfer feature.

Activating Centrex Transfer via Remote Call Forwarding is just like activating regular Remote Call Forwarding and requires that Remote Call Forwarding be enabled for the extension. However, the user dials \* instead of a dial-out code, and a Pause character may be required after the \*. The Centrex service provider determines whether the Pause is needed.

Pause cannot be originated from a single-line telephone or a remote access user. A multiline telephone user in the local system must enter an authorization code to activate the feature.

A remote access user may activate the feature without using an authorization code. Barrier code requirements do apply, however.

## **Authorization Codes and Remote Call Forwarding**

---

In Release 6.0 and later Key or Hybrid/PBX mode systems, forwarding features, including Centrex Transfer via Remote Call Forwarding, but excluding Follow Me, can be activated or deactivated at a multiline telephone by entering the authorization code for the extension from which calls are to be forwarded. The user enters the authorization code, then activates or deactivates the forwarding feature in the normal fashion. This is especially useful for a single-line telephone user who must include a Pause character in a Centrex Transfer via Remote Call Forwarding dialing sequence, because the character cannot be dialed at a single-line telephone. It is also useful when activating Call Forwarding or Remote Call Forwarding at phantom stations, or via remote access (e.g. from another switch in the network). No other features can be used by entering an authorization code in this fashion.





# IMPORTANT SAFETY INSTRUCTIONS



The exclamation point in an equilateral triangle is intended to alert the user to the presence of important operating and maintenance (servicing) instructions in the literature accompanying the product.

When installing telephone equipment, always follow basic safety precautions to reduce the risk of fire, electrical shock, and injury to persons, including:

- Read and understand all instructions.
- Follow all warnings and instructions marked on or packed with the product.
- Never install telephone wiring during a lightning storm.
- Never install a telephone jack in a wet location unless the jack is specifically designed for wet locations.
- Never touch uninsulated telephone wires or terminals unless the telephone wiring has been disconnected at the network interface.
- Use caution when installing or modifying telephone lines.
- Use only Lucent Technologies-manufactured MERLIN LEGEND Communications System circuit modules, carrier assemblies, and power units in the MERLIN LEGEND Communications System control unit.
- Use only Lucent Technologies-recommended/approved MERLIN LEGEND Communications System accessories.
- If equipment connected to the analog extension modules (008, 408, 408 GS/LS) or to the MLX telephone modules (008 MLX, 408 GS/LS-MLX) is to be used for in-range out-of-building (IROB) applications, IROB protectors are required.
- Do not install this product near water, for example, in a wet basement location.
- Do not overload wall outlets, as this can result in the risk of fire or electrical shock.
- The MERLIN LEGEND Communications System is equipped with a 3-wire grounding-type plug with a third (grounding) pin. This plug will fit only into a grounding-type power outlet. This is a safety feature. If you are unable to insert the plug into the outlet, contact an electrician to replace the obsolete outlet. Do not defeat the safety purpose of the grounding plug.

- The MERLIN LEGEND Communications System requires a supplementary ground.
- Do not attach the power supply cord to building surfaces. Do not allow anything to rest on the power cord. Do not locate this product where the cord will be abused by persons walking on it.
- Slots and openings in the module housings are provided for ventilation. To protect this equipment from overheating, do not block these openings.
- Never push objects of any kind into this product through module openings or expansion slots, as they may touch dangerous voltage points or short out parts, which could result in a risk of fire or electrical shock. Never spill liquid of any kind on this product.
- Unplug the product from the wall outlet before cleaning. Use a damp cloth for cleaning. Do not use cleaners or aerosol cleaners.
- Auxiliary equipment includes answering machines, alerts, modems, and fax machines. To connect one of these devices, you must first have a Multi-Function Module (MFM).
- Do not operate telephones if chemical gas leakage is suspected in the area. Use telephones located in some other safe area to report the trouble.



**WARNING:**

- *For your personal safety, DO NOT install an MFM yourself.*
- *ONLY an authorized technician or dealer representative shall install, set options, or repair an MFM.*
- *To eliminate the risk of personal injury due to electrical shock, DO NOT attempt to install or remove an MFM from your MLX telephone. Opening or removing the module cover of your telephone may expose you to dangerous voltages.*

## SAVE THESE INSTRUCTIONS

## About This Book

---

The MERLIN LEGEND Communications System is an advanced digital switching system that integrates voice and data communications features. This guide provides information about the networking capabilities of MERLIN LEGEND Communications System Release 6.1 (Hybrid/PBX mode), including tandem trunking, tandem switching, and related private network features.

## Intended Audience

---

This book is specifically designed to help you fulfill your role as system manager of the MERLIN LEGEND Communications System Release 6.1. It is designed to help system managers understand the concepts behind these private networks so that you can plan and maintain networked systems. If you have little or no knowledge of the system, you should consult other system documents before attempting to work with private networks. See [“Related Documents” on page xxx](#) for a list of these guides.

This guide is also helpful to MERLIN LEGEND Communications System distributors and to Lucent Technologies employees working with networked systems.

## How to Use This Book

---

This guide includes five chapters:

- **Chapter 1, Introduction.** This chapter provides a grounding in the basic terminology and concepts that you must understand in order to manage a networked system.
- **Chapter 2, Call-Handling Scenarios.** Studies several sample network configurations, demonstrating how the systems are set up for networking, how calls are made and received, and the advantages and disadvantages of each configuration.
- **Chapter 3, Feature Interactions.** Describes the ways that system features work in networks.
- **Chapter 4, Security.** Discusses security issues and considerations.
- **Chapter 5, Network Management.** Summarizes programming procedures for setting up and modifying network operations.
- **Chapter 6, Troubleshooting.** Describes common problems that you may encounter, their possible causes, and their solutions.

This guide is intended as a companion to the Release 6.1 *Feature Reference*, *System Programming*, and *System Manager's Guide*, which explain many system features and procedures in greater detail. Because private networks leverage existing communications system features as well as introducing new ones, this guide focuses not on a thorough discussion of system management and system features but rather on how they apply to private networks. ["Related Documents" on page xxx](#) provides a complete list of system documentation together with ordering information.

**In the USA only**, Lucent Technologies provides a toll-free customer Helpline 24 hours a day. Call the Helpline at 1 800 628-2888 (consultation charges may apply), or call your Lucent Technologies representative, if you need assistance when installing, programming, or using your system.

## Terms and Conventions Used

---

The terms described here are used in preference to other, equally acceptable terms for describing communications systems.

### Lines, Trunks, and Facilities

*Facility* is a general term that designates a communications path between a telephone system and the telephone company central office. Technically, a *trunk* connects a switch to a switch, for example, the MERLIN LEGEND Communications System to the central office. Technically, a *line* is a loop-start facility or a communications path that does not connect switches, for example, an intercom line or a Centrex line. However, in actual usage, the terms *line* and *trunk* are often applied interchangeably. In this guide, we use *lines/trunks* and *line/trunk*

to refer to facilities in general. Specifically, we refer to digital *facilities*. We also use specific terms such as *personal line*, *ground-start trunk*, *DID trunk*, and so on. When you talk to your local telephone company central office, ask about the terms they use for the specific facilities they connect to your system.

## Typographical Conventions

---

Certain type fonts and styles act as visual cues to help you rapidly understand the information presented:

Example	Purpose
It is <i>very</i> important that you follow these steps. You <i>must</i> attach the wristband before touching the connection.	Italics indicate emphasis.
The part of the headset that fits over one or both ears is called a <i>headpiece</i> .	Italics also set off special terms.
If you press the <b>Feature</b> button on an MLX display telephone, the display lists telephone features you can select. A programmed Auto Dial button gives you instant access to an inside or outside number.	The names of fixed-feature, factory-imprinted buttons appear in bold. The names of programmed buttons are printed as regular text.
Choose Ext. Prog from the display screen.	Plain constant-width type indicates text that appears on the telephone display or PC screen.
To activate Call Waiting, dial <i>*11</i> .	Constant-width type in italics indicates characters you dial at the telephone or type at the PC.

## Product Safety Labels

---

Throughout these documents, hazardous situations are indicated by an exclamation point inside a triangle and the word *CAUTION* or *WARNING*.



**WARNING:**

*Warning indicates the presence of a hazard that could cause death or severe personal injury if the hazard is not avoided.*



**CAUTION:**

*Caution indicates the presence of a hazard that could cause minor personal injury or property damage if the hazard is not avoided.*

## Security

---

Certain features of the system can be protected by passwords to prevent unauthorized users from abusing the system. You should assign passwords wherever you can and limit knowledge of such passwords to three or fewer people.

Nondisplaying authorization codes and marked System Speed Dial numbers provide another layer of security. For more information, see Appendix A, "Customer Support Information."

Throughout this document, toll fraud security hazards are indicated by an exclamation point inside a triangle and the words *SECURITY ALERT*.



### **SECURITY ALERT:**

*Security Alert indicates the presence of a toll-fraud security hazard. Toll fraud is the unauthorized use of your telecommunications system by an unauthorized party (for example, persons other than your company's employees, agents, subcontractors, or persons working on your company's behalf). Be sure to read "Your Responsibility for Your System's Security" on the inside front cover of this book and "Security of Your System: Preventing Toll Fraud" in Appendix A, "Customer Support Information."*

## Related Documents

---

In addition to this book, the documents listed below are part of the documentation set. Within the continental United States, these can be ordered from the Lucent Technologies Fulfillment Center at 1 800 457-1235 from within the continental U.S. or 1 317 322 6791 from outside the continental U.S.

Document No.	Title
	<b>System Documents</b>
555-661-100	<i>Customer Documentation Package*</i>
555-661-110	<i>Feature Reference</i>
555-661-111	<i>System Programming</i>
555-661-112	<i>System Planning</i>
555-661-113	<i>System Planning Forms</i>
555-661-116	<i>Pocket Reference</i>
555-661-118	<i>System Manager's Guide</i>
555-661-150	<i>Network Reference</i>
555-661-800	<i>Customer Reference CD-ROM†</i>
	<b>Telephone User Support</b>
555-661-120	<i>Analog Multiline Telephones User's Guide</i>
555-661-122	<i>MLX Display Telephones User's Guide</i>
555-661-124	<i>MLX-5® and MLX-10® Nondisplay Telephone User's Guide</i>
555-661-126	<i>Single-Line Telephones User's Guide</i>

555-661-138	<i>MDC and MDW Telephones User's Guide</i>
555-631-150	<i>MLX-10D Display Telephone Tray Cards (5 cards)</i>
555-631-155	<i>MLX-16DP Display Telephone Tray Cards (5 cards)</i>
555-631-152	<i>MLX-28D and MLX-20L Telephone Tray Cards (5 cards)</i>
555-631-151	<i>MLX-10 and MLX-5 Nondisplay Telephone Tray Cards (6 cards)</i>
	<b>System Operator Support</b>
555-661-132	<i>Analog Direct-Line Consoles Operator's Guide</i>
555-661-134	<i>MLX Direct-Line Consoles Operator's Guide</i>
555-661-136	<i>MLX Queued Call Console Operator's Guide</i>
	<b>Miscellaneous User Support</b>
555-661-130	<i>Calling Group Supervisor's Guide</i>
555-641-105	<i>Data/Video Reference</i>
555-025-600	<i>BCS Products Security Handbook</i>
	<b>Documentation for Qualified Technicians</b>
555-661-140	<i>Installation, Programming, &amp; Maintenance (IP&amp;M) Binder</i> Includes: <i>Installation, System Programming &amp; Maintenance (SPM), and Maintenance &amp; Troubleshooting</i>
555-661-111	<i>System Programming</i>
<b>Document No.</b>	<b>Title</b>
	<b>System Documents</b>

\* The Customer Documentation Package consists of the paper versions of the *System Manager's Guide*, *Feature Reference*, and *System Programming*.

† The Customer Reference CD-ROM contains the *System Manager's Guide*, *Feature Reference*, *System Programming*, and *Network Reference*.

## **How to Comment on This Book**

---

We welcome your comments, both positive and negative. Please use the feedback form on the next page to let us know how we can continue to serve you. If the feedback form is missing, write directly to:

Documentation Manager  
Lucent Technologies  
211 Mount Airy Road, Room 2W226  
Basking Ridge, NJ 07920



# Introduction

# 1

---

This chapter describes the terminology and concepts that you should understand before you plan and maintain a networked system. It includes the following topics:

- **Networking Concepts.** In simple terms, explains what private communications networks are, the benefits they offer organizations, and fundamental concepts such as tandem switching and tandem trunking.
- **Tandem Switching and Tandem Trunking.** Expands on the definitions of tandem trunking and tandem switching by showing simple examples of how these features are put into practice in different private network configurations using different types of lines/trunks.
- **Uniform Dial Plan (UDP).** Introduces the feature that allows system managers in a private network to set up a dial plan for reaching extensions at remote networked systems.
- **Centralized Voice Messaging.** (Release 6.1 and later systems.) Adds the capabilities of a centralized VMS/AA in a MERLIN LEGEND Communications system private network.

## Networking Concepts

---

In today's environment—business, academic, and governmental—many organizations are setting up multiple sites to provide customers and clients with better access to products and services. Branch offices, operations centers, and specialized campuses are supported by technological advances such as local area networks (LANs) and wide area networks (WANs), intranets, the Internet, videoconferencing, and protocols that enable high-speed data communications. For example, banking institutions and insurance companies often consist of a headquarters with branch offices; school systems are organized around a central administrative site that serves several schools in a district. Direct marketing retailers, utilities, and government agencies are dispersed over multiple sites, nationwide or regionally, to reach more clients or customers and to take advantage of the economies offered by specific geographic locations. All of these organizations share a common need: rapid and cost-efficient voice and data communications. For users of the MERLIN LEGEND<sup>®</sup> Communications System, Release 6.0 introduces the ability to realize significant savings and convenience benefits through the networking of geographically separate locations in private communications networks. Release 6.1 adds to the savings and convenience benefits by providing a centralized voice messaging capability for networked MERLIN LEGEND systems.

Briefly, a *private communications network* is an interconnected group of communications systems, which may consist of MERLIN LEGEND Communications Systems, DEFINITY<sup>®</sup> Enterprise Communications Servers (ECS), and/or DEFINITY ProLogix Solutions. People within each system, called *local users*, can exchange voice and data with other individuals at communications systems in the network, called *non-local users*. The systems in a private network may be located on the same campus, or they may be separated by thousands of miles.



**NOTE:**

All MERLIN LEGEND Communications Systems in a private network must be Release 6.0 or later. When centralized voice messaging is used, all MERLIN LEGEND systems that share the centralized voice messaging system must be Release 6.1 or later. While DEFINITY systems can be included in a private network with MERLIN LEGEND systems, the DEFINITY system cannot share the centralized voice mail system of the MERLIN LEGEND system, and the MERLIN LEGEND system cannot share the voice mail system of the DEFINITY system.

Communications systems are linked by special facilities called *tandem trunks*. These lines/trunks may be analog *tandem tie trunks*, T1-emulated tie trunks, or *tandem Primary Rate Interface (PRI) trunks*. As a group, they can be referred to as *private network trunks*, because they enable private networks.

Private networks are distinct from the *public switched telephone network (PSTN)* of facilities that link customers with central office (CO) service providers across the nation and the world. PSTN lines and trunks allow you to communicate with local and long-distance parties outside your organization.

Private communications networks are not simply communications systems chained together by tandem trunks. They also allow *tandem switching*, which permits a communications system to route a call from outside a local system to an *outside* facility on a non-local system. In addition, a MERLIN LEGEND Communications System can route calls from a tandem trunk to a local extension.



**NOTE:**

In this guide, *switch* is often used to mean *communications system*. For the purposes of this guide, a *private network* denotes a network with tandem trunks and tandem switching.

In a private network, correct operation requires that planning be coordinated for all systems. If a private network includes only two systems, this may simply mean that the system managers get together to assure that the correct programming is performed initially, that each manager has a copy of the system forms for the other system, and that the system managers discuss and agree upon any subsequent modifications. In a larger private network, a *coordinating system manager* should be appointed. This person should keep copies of all system forms for all systems in the private network. When a change must be made at a local system, it should be cleared through the coordinating system manager, who assesses the change as it affects the private network as a whole. If a change in one system requires modifications in other networked systems, the coordinating system manager ensures that these changes are made.

If these terms and concepts are new to you, do not be alarmed. There is no need to comprehend them immediately. You will gain a better understanding as you learn the practical applications of these concepts.

## Benefits of Networking

---

Available for Hybrid/PBX mode systems, the private network features of the MERLIN LEGEND Communications System Release 6.0 and later provide the following advantages for geographically dispersed organizational sites:

- **Toll Savings.** Private networked trunks allow you to realize significant cost savings on toll calls by performing tandem switching in the following two ways:
  - Callers on a local system can reach the PSTN via outside trunks connected to other systems in a private network, avoiding toll charges or substantially decreasing the cost of toll calls. For example, if you are in Cincinnati and another site in your company is in Dallas, you can make a call to a number in the Dallas local calling area over your private network, decreasing toll costs.
  - In addition, organizations use private networked trunks to make calls between networked systems, which may be geographically distant from one another. Using the example above, from your office in Cincinnati you can dial an extension at a sister site in Dallas, just as you would dial an extension on your own local system, without a costly long-distance phone call. You simply dial the extension number.
- **Service Cost Savings.** In addition to toll call savings, there are two other ways that organizations can save on service costs incurred from telecommunications providers that provide PSTN access:
  - You order a point-to-point T1 circuit from a service provider, then use system programming to set it up for tandem PRI services. As necessary, a service provider provides amplification for PRI tandem trunks in cases where the distance between networked systems is great enough to distort signals, but the service provider does not supply switching services.
  - You can tailor your use of PRI B-channels with drop-and-insert equipment that allows fractional use of T1 channels for non-MERLIN LEGEND data/video communications between sites, while keeping the remaining T1 channels for PRI voice or data traffic.



### NOTE:

The 24th T1 channel must not be dropped before reaching the MERLIN LEGEND Communications System because MERLIN LEGEND uses the 24th channel as the PRI D-channel or signalling channel.

- You can tailor your use of T1 channels to support a mix of T1-emulated tandem tie trunks for voice or data communications at 56 kbps per channel, allowing 2B data transfers at 112 kbps. The system also allows fractional use of point-to-point T1 tandem trunks with drop-and-insert equipment.

- **Improved Efficiency.** In Release 6.1 and later systems, you can save on resource costs, enhance customer service, and improve productivity in the following ways:
  - Coverage and overflow calls can be sent to a remote system using calling groups, increasing the number of coverage points and allowing sharing of personnel and resources between systems.
  - A centralized VMS/AA provides additional savings by eliminating the need for a voice messaging system at each location in the private network.
  - A centralized VMS/AA improves productivity and communications by allowing users to forward and broadcast messages regardless of location.
  - Calls can be forwarded to a non-local extension providing mobility to personnel around the private network.
  - Personal messages can be retrieved from anywhere in the private network using the same method and extension.
  - Incoming calls on any line type at any system can be routed to another system for improved customer service and reduced customer calling expense.

## **Tandem Trunking and Tandem Switching**

The term *tandem switching* describes the process of routing an incoming call over an outgoing tandem trunk or PSTN facility. If the outgoing trunk is a tandem trunk, it connects to another system in a private network. When the call terminates at an extension on a non-local system, it is an *intersystem call*. Release 6.0 provides enhanced underlying capabilities to satisfy recommended levels of voice and data quality over tandem trunks in a private network.

A tandem-switched call does not necessarily terminate at another system that is directly connected to your own. It may travel over the private network to yet another networked system. Furthermore, a non-local system may direct the call to a PSTN facility and then to someone located outside the private network.

For example, from a system in Minneapolis, a long-distance call to an outside party in Boston can be routed over private tandem trunks to another system in Chicago and then to a system in Boston, resulting in a local call. This routing requires that the private network sites be connected using either a *delay-start* tie line (analog or T1-emulated) or a digital T1 circuit that has been programmed for PRI.

[Figure 1-1](#) shows one way that systems can be connected in a private network.



### **NOTE:**

All of the figures in this chapter use the following conventions:

- A solid line represents a tandem trunk that connects one system in a private network to another system in a private network.
- A dashed line represents a facility that carries a call to the PSTN.
- A square labeled **ML** indicates a MERLIN LEGEND Communications System.
- A rounded rectangle labeled **DEF** indicates a DEFINITY ECS or DEFINITY ProLogix Solutions system.

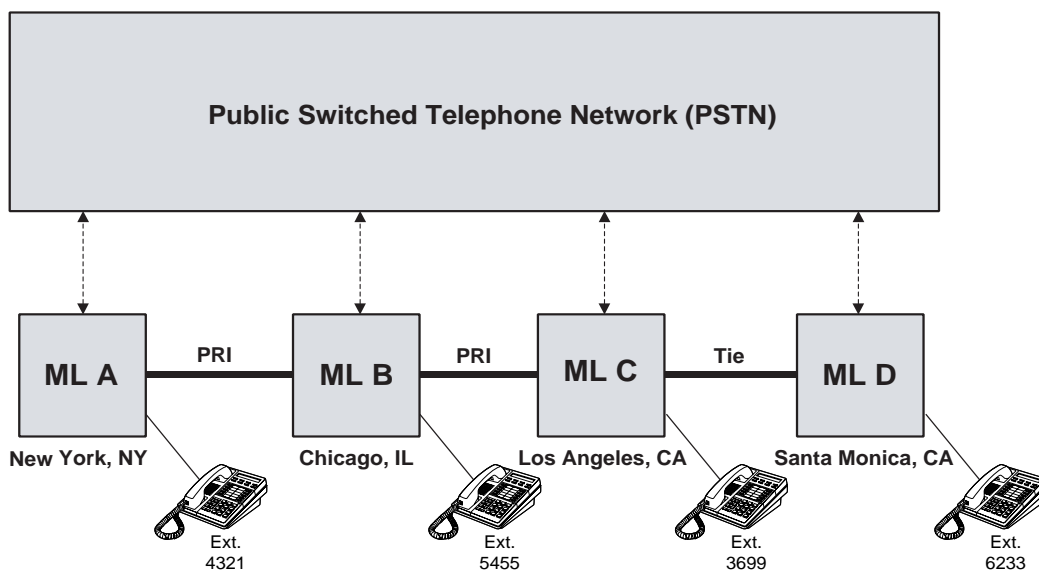

Figure 1-1. Series Configuration

To make a call from System A to System C, a user at Extension 4321 dials 3699 to reach Extension 3699. The call travels over tandem trunks through System B to System C without using the PSTN to provide switching services. Systems B and C in this *series configuration* are called *tandem switches*.

Using another aspect of tandem switching, the user at Ext. 3699 employs Automatic Route Selection (ARS) normally in order to dial a number in the New York area code, 912125551234, for example, where 9 is the ARS code. In this case, the call is routed from System C to System A over tandem trunks. At System A, the call goes out over a facility connected to the PSTN as a local call from System A.

These two calls have the following features in common:

- All or part of each call is carried over tandem trunks.
- The calls are routed seamlessly from a system extension to a destination.
- The calls can result in substantial savings over the cost of the same calls using telecommunications service providers and the PSTN.
- The users dial the calls normally: one is an inside call and one is an ARS call made on a System Access (**SA**) button. ARS and Universal Dial Plan (UDP) routing are programmed to take advantage of all PSTN facilities in the network.

In the next sections, we will look at this and other private network configurations and examine more carefully the tandem trunks that link systems in private networks.

## Network Configurations

This topic looks at some sample private network configurations and the differences among them. It does not illustrate *all* of the possible ways that private networks can be connected.

[Figure 1-1](#), as noted above, shows a series configuration, where systems are arranged in a line with no central system acting as a hub. In [Figure 1-1](#), Systems A and D are *peripheral* systems, because neither connects to more than one switch in the private network. Note that a series configuration can consist of only two systems.

[Figure 1-2](#) shows the second possible arrangement for private networks, called a *star configuration*.

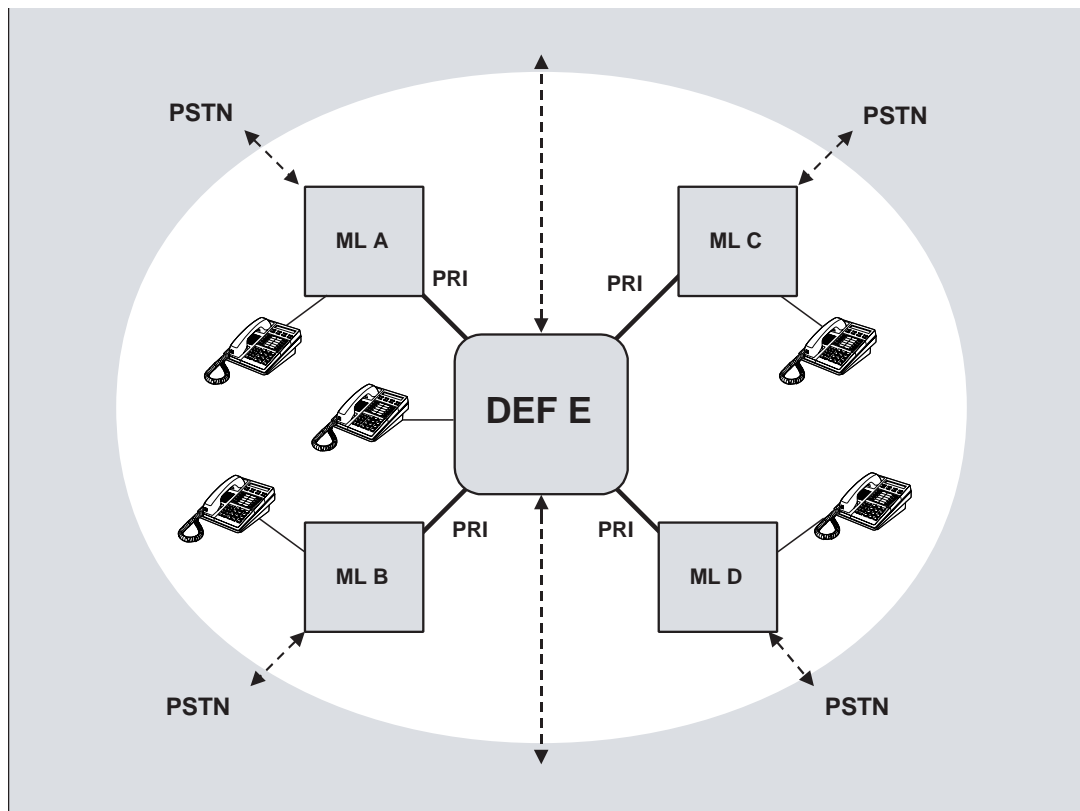

Figure 1-2. Star Configuration: Five Systems



In this example, system users make calls in the same way as they would in a series configuration. The primary difference between a star configuration and a series configuration is that in a star configuration all network-routed calls pass through a central *hub system*, in this case, a DEFINITY ECS or DEFINITY ProLogix Solutions system. The hub normally terminates stations as well as external facilities.

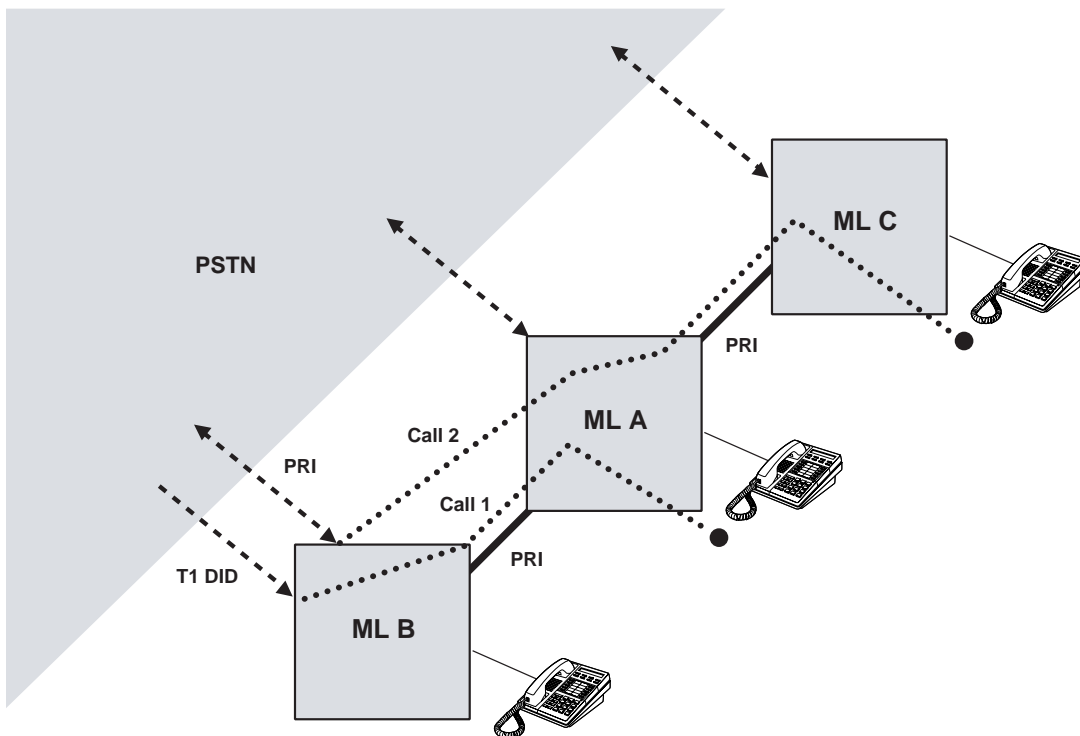

Figure 1-3. Star Configuration: Three Systems

Figure 1-3 shows a simpler star configuration consisting only of MERLIN LEGEND Communications Systems. It may look like a series, but all network-routed calls pass through a central hub, System A, just as they do in the larger star configuration. This illustration also shows how PSTN calls can be routed in a private network.

Figure 1-3 shows some specific PSTN facilities as well as tandem trunks. Calls 1 and 2, represented by dotted lines, can enter the private network and be routed directly through System B to extensions on System C and System A. Both Direct Inward Dialing (DID) and PRI outside facilities permit this type of routing. However, the types of tandem trunks that connect the systems, as well as the lines/trunks connecting to the PSTN, also affect the decisions that you make

about private network configurations. In the next topic, we will revisit all three of these configuration diagrams.

## Lines and Trunks

---

The types of tandem trunks that connect systems in a private network, as well as the types of facilities that connect systems to the PSTN affect the performance and available features in a private network. This topic examines the distinctions among trunks and the important decision factors that you must consider when you set up your private network. It also discusses the advantages and disadvantages of the configurations we looked at in the previous section.

Tandem PRI facilities have numerous advantages over the tandem T1-emulated or analog tie trunks that can link systems in a private network. [Table 1-1](#) summarizes the differences. In Chapter 2, "Call-Handling Scenarios," you will learn more about the details of the features that are noted here.



**NOTE:**

Centralized Voice Messaging is available for Release 6.1 and later systems only. For Release 6.0 systems, disregard the Centralized Voice Messaging capability in the following topics because each system must have its own voice messaging application.

**Table 1-1. Tandem PRI Trunks versus Tandem Tie Trunks**

<b>Feature</b>	<b>PRI</b>	<b>Tie</b>	<b>Differences</b>
Intersystem calling	✓	✓	PRI provides faster call setup.
For intersystem calls, the caller's extension label and extension number can be displayed at recipient's MLX (and some DEFINITY) display telephones across the network.	✓		Calls that cross tandem tie trunks are displayed as outside calls.
Manual intersystem transfers across the private network return to the originator when the intended destination is busy or has Do Not Disturb on and no call coverage path available.	✓		When a call is transferred manually across the network on tandem tie facilities, the call does not return in the event that the intended destination is busy. The original caller must call back in order to speak with someone.
Dial-plan routing of calls on incoming PSTN PRI trunks across the private network.	✓	✓	PRI provides faster call setup.
Automatic Number Identification (ANI) and Incoming Caller ID (ICLID)	✓		Information is conveyed across the network on tandem PRI trunks, not on tie trunks.
Routing of PSTN DID calls across the network.	✓	✓	
128-kbps 2B data video and data exchange across the network.	✓		Tie trunks support only 14.4 kbps. T1-emulated tie trunks programmed for data can only support up to 112 kbps.
Optimal transmission quality for calls routed across two or more systems in a private network.	✓	✓	To ensure adequate transmission quality, no more than two spans of analog tandem tie trunks can be provided between switches in a series configuration (or 3 including transfers and coverage). Also, for long loops of analog tandem tie trunks between switches, you may need to contact the PSTN service provider to adjust the amplification.  Transmission quality on PRI and T1 tandem trunks are the same. Up to eight tandem PRI and/or T1 trunks can be used in a series configuration providing optimal transmission quality. However, T1 tandem trunks may cause call setup delays.

---

Touch Tone Receivers	None	✓	Required for all calls routed across the private network on tie trunks. (Voice messaging increases traffic in both directions.) Not required on PRI trunks.
----------------------	------	---	---

---

Centralized Voice Messaging

■ Call information indicating inside call		✓	With PRI, the call information signals sent by the remote system to the centralized VMS indicates inside calls. With tie trunks, the call information signals for all calls indicates an outside call.
■ Message Waiting light updates	✓	✓	With PRI, the Message Waiting lights are updated on the signalling D-channel. With tie trunks, Message Waiting lights updates are sent as separate voice calls and must compete with other voice and data calls for an available tie trunk and touch tone receiver. As a result, the Message Waiting light updates may be delayed on tie trunks.

---

The advantages of tandem PRI facilities are illustrated in practical terms in Chapter 2, "Call-Handling Scenarios." However, tandem PRI trunks do present the following challenges that affect your configuration planning.

- Each PRI facility connected to a system, whether it is a tandem trunk or an outside facility and whether or not drop-and-insert equipment is used between systems, takes up 24 of the 80-line capacity of a MERLIN LEGEND Communications System.
- Each 800 NI-1BRI module takes up to 16 of the 80-line capacity.
- Each 400EM tie module takes up to 4 of the 80-line capacity.

In view of this fact and the differences noted in [Table 1-1](#), we will briefly revisit the private network configurations we looked at earlier.

The next three figures show basically the same configurations that you saw before, slightly modified to emphasize the differences among them. The figures shown are only a few examples for illustration, and do not represent all possible configurations. In these figures, the lines and trunks literally represent the number of facilities connected to each system in a given configuration. The PSTN facilities shown here are only examples. You can connect the same types of loop-start, ground-start, T1 Switched 56, DID (Direct Inward Dialing), and T1-emulated analog lines/trunks to a private network system that you can to a non-networked system.



**SECURITY ALERT:**

*Do not connect T1-emulated loop-start lines or analog loop-start lines without reliable disconnect to any switch that is part of a private network.*



**NOTE:**

In the following example, the PRI tandem trunks are implemented on T1 circuits provisioned for bipolar 8 zero substitution (B8ZS) line code.

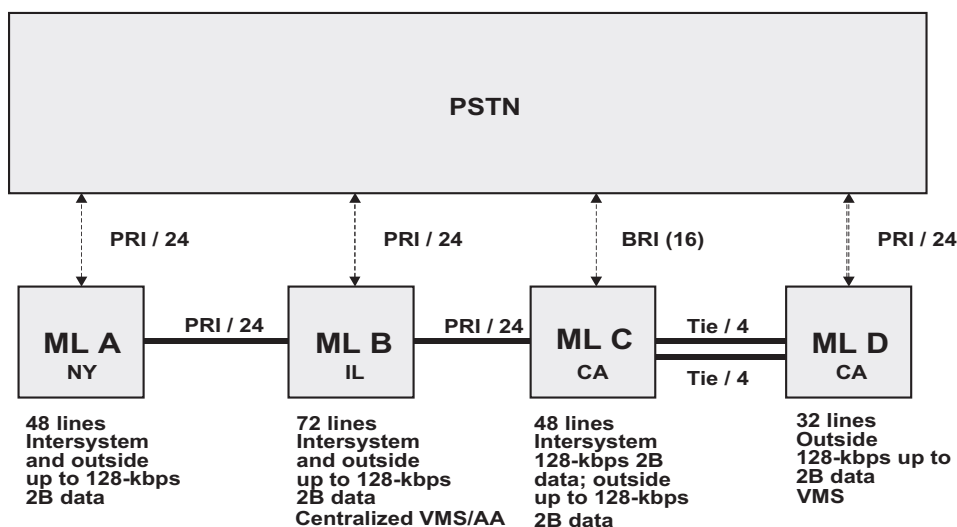

**Figure 1-4. Series Configuration: Four Systems**

From a planning perspective, consider the following points about the series configuration illustrated in [Figure 1-4](#).

- System D is linked to the private network by tie lines (a total of 8), so users at MLX display telephones on System D cannot see the name and/or number of a caller who reaches them from another system in the private network.
- To ensure proper transmission quality, the path of a private network call should include no more than two *spans* of analog tie trunks. The private network in [Figure 1-4](#) includes one such span, between Systems C and D.
- When an outside dial-plan routed PRI call with ANI arrives on System A or B, ANI calling party information travels to a destination extension on systems connected by PRI tandem trunks (A, B, or C) but not across tie tandem trunks (System D). System D users can receive this information only from their PRI to the PSTN.
- System D is located in close geographic proximity to System C. This allows System D to use the PSTN for 2B video calls with System C at up to 128 kbps without incurring high toll costs. However, because of the tie connections, intersystem video and intersystem high-speed data calls are not supported to and from System D.

- In this configuration, System B uses more of its 80-line capacity for private network trunks than do Systems A, C, and D.
- A centralized VMS/AA is installed on System B. Voice mail and automated attendant services can be used by extensions and calling groups on Systems A, B, and C. Since Systems A and C are connected to System B via a PRI tandem trunk, Message Waiting light updates are sent over the signalling D-channels. The call information signals sent by Systems A and C to the centralized VMS/AA on System B allow the centralized VMS/AA to differentiate between inside and outside calls. Some applications (such as Intuity AUDIX) use the information to play different personal greetings recorded by users for inside and outside callers.
- Since System D is not directly connected by a tandem trunk to System B, System D must have its own local voice mail system and automated attendant.

The configuration illustrated in [Figure 1-4](#), with its advantages and disadvantages, is suitable for many businesses, particularly when one or more systems do not require PRI features. For example, a system linked by tandem tie trunks may be perfectly adequate for a warehouse or other operations group.

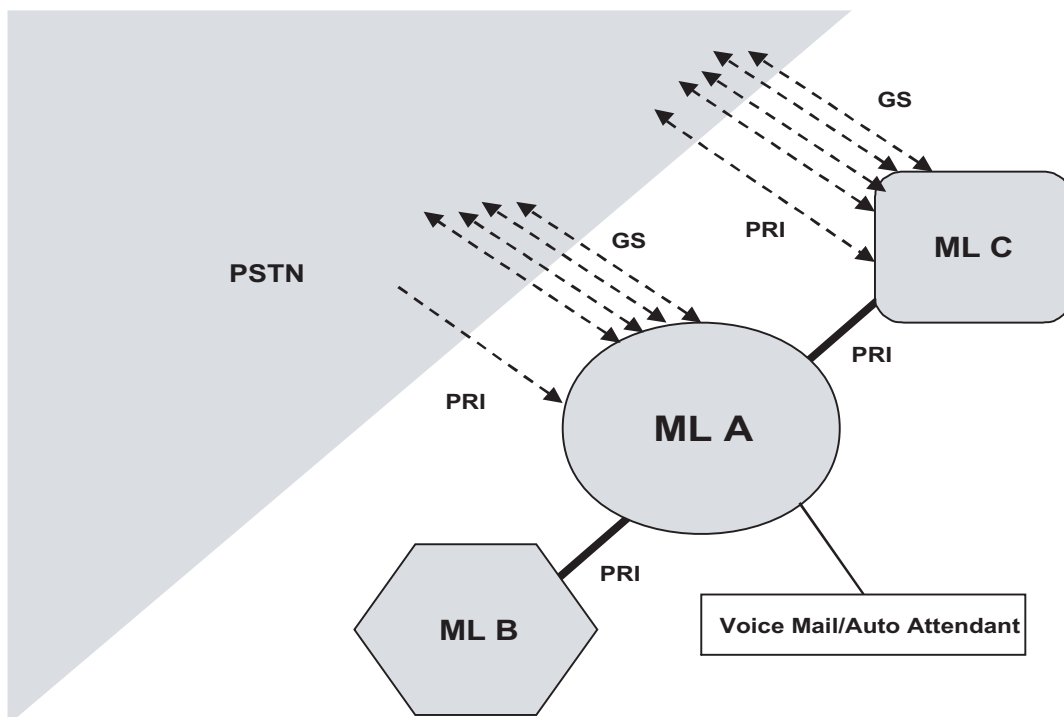

Figure 1-5. Star Configuration: Three Systems

In [Figure 1–5](#), the 3-system star configuration that we saw earlier has been modified to bring out some additional possibilities for private network configurations. Consider the following points as you review this graphic:

- All three systems are Release 6.1 or later systems and enjoy the advantages of tandem PRI trunks, including MLX telephone display capabilities and high-speed data communications among networked systems.
- System B is a corporate data-processing center with no facilities connected to the PSTN. It is located in the same building as System A. Outside calls for System B arrive at System A. All intersystem calls pass through System A, the hub system.



**CAUTION:**

*Unless networked systems are co-located, each system should have at least one loop-start line connected to the PSTN. The line is required to allow connection of a power-failure telephone to the Power-Failure Transfer (PFT) jack on a module as a power outage backup and for correct routing of emergency and other N11 (911, 411, etc.) calls. To ensure that the correct services are reached, if the loop-start line is used for emergency or other N11 calls, it should be assigned to the main pool. In this case, inter-exchange (IXC) calls determine the number of loop-starts required. Refer to Feature Reference guide for details on the PFT feature.*

- PRI dial-plan routed calls arrive at System C, where they are routed to a telemarketing calling group on System A. These agents primarily use the outside PRI facility connected to their system to return customer calls.
- Both System B and System C share the voice mail/automated attendant application connected to System A. Calls are routed from the automated attendant to users on all these systems.



**NOTE:**

For Release 6.0 networks, Centralized Voice Mail is not available. Each system must have its own voice mail application for voice mail coverage. However, with Release 6.0 Version 11 and later systems, calls can be routed over the private network from a centralized automated attendant.

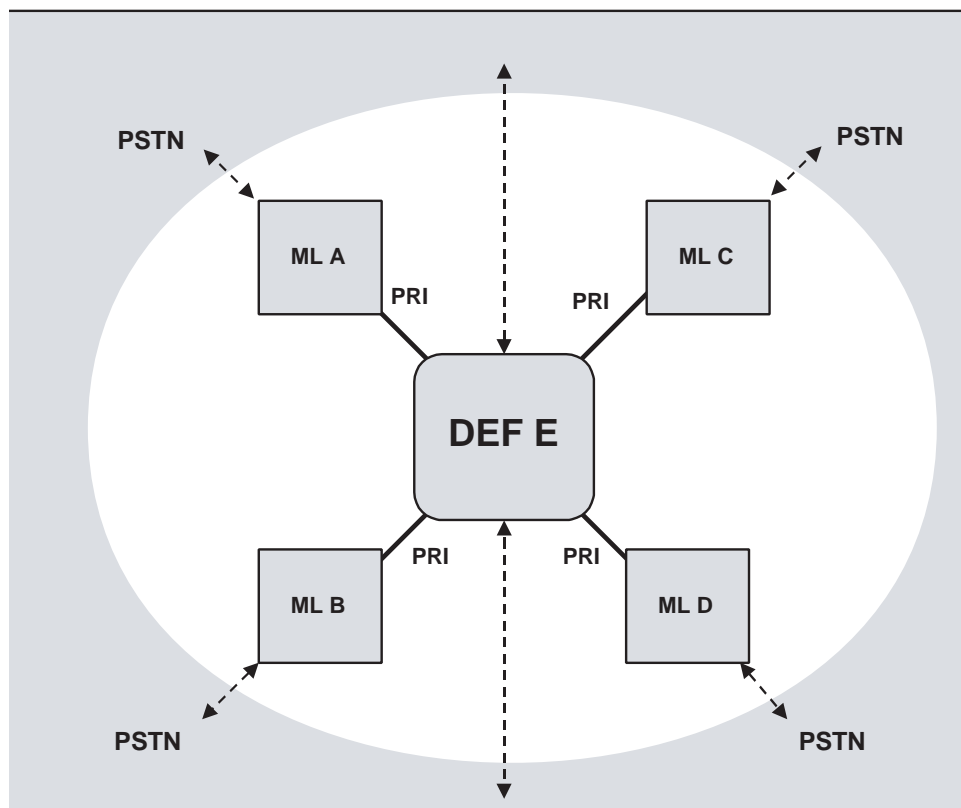

**Figure 1-6. Star Configuration: Five Systems**

[Figure 1-6](#) again shows the star configuration we looked at earlier in this chapter. All systems enjoy the advantages of PRI tandem trunks, which are made possible in this larger private network by the greater line capacity of the hub DEFINITY ECS or DEFINITY ProLogix Solutions, System E. In this private network, the systems may be spread across thousands of miles and realize considerable toll savings on intersystem calls and long-distance ARS calls. Although not shown, each system has its own voice mail/automated attendant system because the MERLIN LEGEND systems and the DEFINITY system cannot share voice messaging systems.



## Software Defined Network (SDN) Configuration

Support for AT&T's Software Defined Network (SDN) was first offered with MERLIN LEGEND in Release 2.0. Release 4.2 introduced support for VNET, MCI's version of SDN.



**NOTE:**

Sprint offers VPN Premiere; this virtual network is not supported by MERLIN LEGEND.

With Release 6.0 and later systems, UDP routing via 3-, 4- or 5-digit dialing offers SDN customers simplified dialing. An SDN dialing plan identifies all network locations with a dialing plan of up to 10 digits. Users at all locations in the private network can be identified with 3- or 4-digits (unique). This uniqueness criteria may require some users whose last 3- or 4- digits are identical to change their numbers.

For example, if each MERLIN LEGEND in the private network is configured with a 4-digit dial plan, the routing patterns can be set up to prepend the digits needed to support an SDN 7- or 10-digit dialing plan. To support the 7- digit dial plan, four digits must be prepended; to support the 10-digit dial plan, six digits must be prepended. This configuration must be coordinated with the SDN/VNET provider.

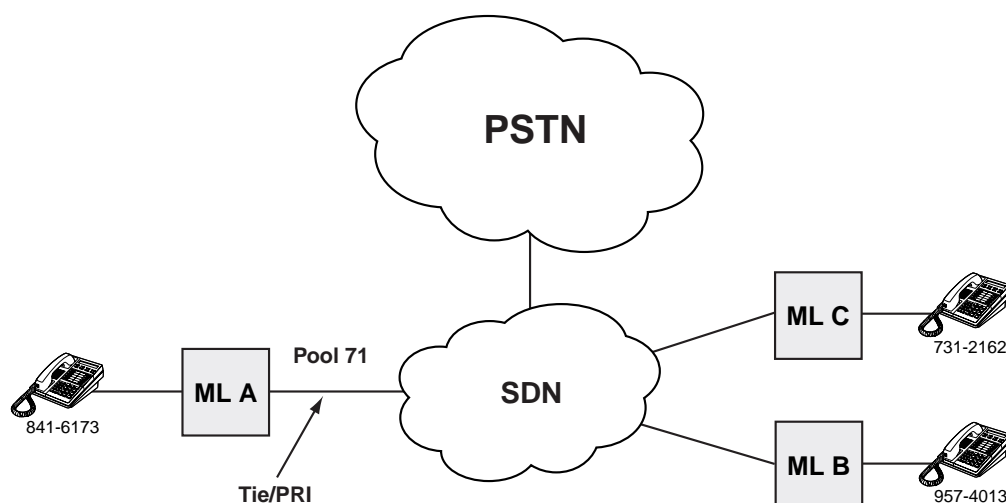

Figure 1-7. Software Defined Network (SDN) Configuration

[Figure 1–7](#) shows three MERLIN LEGEND systems in an SDN network. On System A, the SDN trunks are assigned to pool 71. A user on System A calling the user on System B dials 4013, the last four digits of the SDN number 957-4013. System A routes the call using trunk pool 71 and prepends the digits 957. Similarly, a user on System A calling the user on System C dials 2162. System A routes the call using trunk pool 71 and prepends the digits 731.

The SDN can also be used for all of the toll calls as well as the calls within the SDN. Any 10-digit number from MERLIN LEGEND users that does not fall within the SDN numbering plan for the customer is routed over the PSTN (see [Figure 1–7](#)). This is a standard feature of SDN.

## Considerations

- Whether you are transferring calls to a non-local extension over the Public Switched Network or an SDN, you must program the MERLIN LEGEND to support trunk-to-trunk transfer.



### NOTE:

Trunk-to-trunk transfer is not allowed when the line/trunk with the incoming call is a loop-start line that is not programmed for reliable disconnect.



### SECURITY ALERT:

*Any changes to the trunk-to-trunk transfer setting (especially for voice messaging ports or remote access ports) must be considered carefully in order to minimize the potential for toll fraud. See Appendix A “Customer Support Information” for security information.*

- For Release 6.1 and later systems, Centralized Voice Messaging is not supported in an SDN environment.

## Uniform Dial Plan

---

The private network benefits that we looked at earlier in this chapter are possible through the combination of core system features—primarily Automatic Route Selection (ARS), Remote Access, and PRI support—and two additional features designed specifically for private networks:

- the non-local dial plan, which is part of the Uniform Dial Plan (UDP). UDP can route calls over the private network, SDN, or PSTN.
- the Group Calling enhancement, which allows assignment of a non-local UDP extension as a calling group member. (This feature is available for 6.1 or later systems.)

The use and management of all these features is discussed in Chapters 2, 3, 4, and 5.

This topic presents an overview of how the private network takes advantage of the non-local dial plan feature.

Each switch in the private network has both a local dial plan and a non-local dial plan that together form the UDP. The local dial plan is set up at the local system as in earlier releases, using System Renumbering. The non-local dial plan is a list of up to 50 different extension number ranges for other systems in the private network. When users call one another, the system searches the local dial plan; if the extension number is not found, it consults the non-local dial plan and associated routing information in order to send the call directly or indirectly to another system in the private network. Routing information is programmed into as many as 20 *patterns* consisting of routes. Routes specify pools, voice/data call type, and FRLs similar to those used for ARS.

**NOTE:**

In releases, prior to 6.0, intersystem calls were made by dialing a pool access code followed by the extension number. With Release 6.0 and later systems, the process is simplified by the UDP ranges and routing patterns programmed on the local system so that the system can find non-local extensions and direct calls to them. Actual system numbering is always performed at the local system.

The diagram shown in [Figure 1–8](#) gives an example of the systems in a private network consisting of a MERLIN LEGEND Communications System in New Jersey, another in Illinois, and a third in California. It resembles the private network shown in [Figure 1–3 on page 1–9](#). A caller picks up a telephone at Extension 1000 in New Jersey and dials Extension 3400 to reach a co-worker at the California location. The New Jersey system searches the local dial plan for Extension 3400.

Because Extension 3400 is not located on the New Jersey system, that system checks the non-local dial plan to find the extension number. The non-local dial

plan has two sets of extension ranges, both of which include routing information that directs the call to the same private network trunk. This tandem PRI trunk connects the New Jersey system to the Illinois system. In the non-local dial plan, one extension range specifies the extensions on the system in Illinois, while the other includes the extensions on the system in California.

When the call reaches the Illinois system, that system also checks the local dial plan and then the non-local dial plan. It routes the call over a second tandem PRI trunk to the California system. The system in California searches its local dial plan, finds a match, and directs the call to Extension 3400.

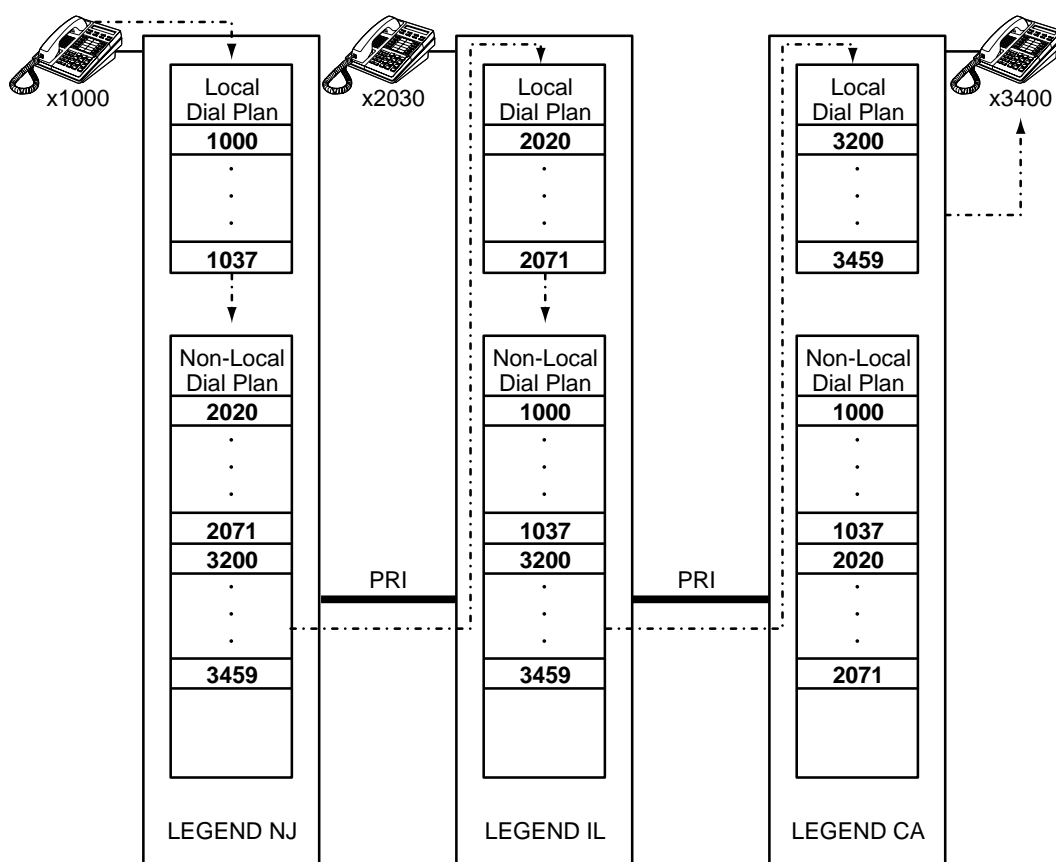

Figure 1-8. Uniform Dial Plans

Each system has its own local system operator, and dialing 0 calls the operator on the local switch. Users can reach an operator on another private network system by dialing that operator's extension number. Alternatively, Listed Directory Number (LDN) calls from one system to another private network system can be routed to the destination system's Queued Call Console (QCC) operator.

In the next chapter, we look at planning and setting up dial plans across a private network, as well as the use of routing and other system management features.

## Centralized Voice Messaging System

---

In Release 6.1 and later, MERLIN LEGEND Communications Systems connected in a private network by tandem trunks may share a centralized voice and fax messaging system and automated attendant (VMS/AA). The centralized VMS/AA is connected to one of the MERLIN LEGEND systems which is then known as the "VMS hub" system. "Remote" MERLIN LEGEND systems which are directly connected to the "VMS hub" system by tandem trunks can then share the Centralized VMS/AA.

Coverage and overflow calls using calling groups from the VMS hub and any of the remote systems can be sent to the centralized VMS/AA. System users retrieving voice mail can call the same number from any location and be directly connected to the centralized VMS/AA. The centralized VMS/AA updates Message Waiting lights across the private network for its subscribers on remote systems.



### NOTE:

A private network can include more than one VMS hub with a centralized VMS/AA system. Each system in the private network may also have local VMS/AA systems. **However, a single extension can have only one voice mailbox.**

## Configuration Requirements

---

A centralized VMS/AA is subject to the following configuration requirements and constraints:

- A DEFINITY ECS or DEFINITY Prologix *cannot* share a centralized VMS/AA with a MERLIN LEGEND system.
- The VMS hub system and all remote systems sharing a centralized VMS/AA must be MERLIN LEGEND Release 6.1 or later systems.
- Each MERLIN LEGEND system must be configured as Hybrid/PBX.
- Networked MERLIN LEGEND systems that are not directly connected to the "VMS hub" system (more than one span away) cannot share the centralized VMS/AA.
- More than one centralized VMS/AA can be configured in a single private network. These centralized VMS/AA systems can share a VMS hub, or have separate VMS hubs.
- Any MERLIN LEGEND system in a private network may also have a local VMS/AA system that is not shared.
- Each extension in the system can have **only one** voice mailbox, no matter how many VMS/AA systems are available.

- Only the following voice messaging systems are supported for centralized VMS/AA:
  - MERLIN LEGEND Mail
  - Messaging 2000
  - Intuity AUDIX
  - IS-III AUDIX Voice Power (no longer orderable)
- A Uniform Dial Plan (UDP) must be established for the private network.
- All trunks within the private network should have unique trunk numbers. This allows the centralized VMS/AA to provide different call handling and/or greetings based on the trunk on which the call was received.
- No more than three (3) analog spans should be involved in any call or volume levels may not be adequate. Multiple spans may be the result of transfers and coverage. If more than three spans may be involved in call completion, digital rather than analog spans should be used.
- Sending overflow or coverage calls to a centralized VMS/AA may add unanticipated traffic to a private network. A call transferred from one system to another and then sent back by overflow or coverage occupies two private network trunks. The MERLIN LEGEND system does not provide release link operation when a call through the private network returns to the originating system.
- Pools within a UDP route cannot mix PRI and tie tandem trunks. The type of signaling is based on the first trunk in the pool, and will not work correctly for subsequent trunks if they are not the same type.
- If tandem tie trunks are used, touch tone receivers (TTR) are required at the hub system and at each remote system for each call (including coverage calls) and for message-waiting light updates over the tie trunks. Voice messaging increases traffic in both directions.

## Tandem Facilities

---

MERLIN LEGEND systems are connected by tandem trunks. Tandem trunks may be tie trunks or PRI trunks:

- A tie trunk may be analog (E & M) or digital (T1). An analog tie trunk carries a single voice call channel. A digital (T1 or fractional T1) tie trunk carries up to 24 voice call channels using a digital encoding scheme. Both use in-band signalling.
- A PRI tandem trunk is a point-to-point T1 circuit programmed in the MERLIN LEGEND systems at both ends as ISDN Primary Rate Interface (PRI). It consists of 23 B-channels for voice calls (digitally encoded) and 1 D-channel (channel 24) for digital signalling information.

The type of tandem trunk used (PRI or tie) has an effect on the operation of the centralized VMS/AA system.

- When a user receives an outside call and the call goes to coverage by a centralized VMS/AA using either tie or PRI tandem trunks, the call information signals sent to the centralized VMS/AA indicate an outside call.
- When a user calls a local extension and the call goes to coverage by a centralized VMS/AA using either tie or PRI tandem trunks, the call information signals sent to the centralized VMS/AA indicate an inside call.
- When a user calls a non-local extension and the call goes to coverage across the private network:
  - If a tie tandem trunk is used to route the original call or to route the coverage call over the private network to the centralized VMS/AA, the call information signals sent to the centralized VMS/AA indicate an outside call.
  - If an all PRI routing is used, the call information signals sent to the centralized VMS/AA indicate an inside call.

This ability to differentiate between inside and outside calls is used by some VMS/AA applications to provide:

- different greetings
- inform the receiver who called
- record a reply to the caller or return a call to the caller

## **Implementation of Centralized VMS/AA**

---

Centralized VMS/AA is implemented using the Group Calling enhancement and UDP routing. Integrated VMI calling groups are defined on the VMS hub system and each remote system.

From the user's point of view, the routing is transparent. The user dials the same extension number from any location in the private network to reach the voice messaging system.

The integrated VMI calling group on the VMS hub system contains the voice messaging system ports. The integrated VMI calling groups on each remote system receive overflow, coverage, and voice mail retrieval calls and route them to the integrated VMI group on the VMS hub system.

Routing to the centralized VMS/AA is done by assigning a single non-local extension as a member of the integrated VMI calling group at each remote system sharing the centralized VMS/AA. This extension has no corresponding physical extension and is referred to as the *VMI conversion number* in this guide.



**NOTE:**

The VMI conversion number should not be published. This prevents users from dialing the VMI conversion number to retrieve messages, which can result in improper operation of the VMS/AA application.

For information about centralized voice message programming, please see: “Centralized Voice Messaging Programming” in Chapter 5. For information about centralized automated attendant programming, please see: “Centralized Automated Attendant Programming” in Chapter 5.

**Example**

For the purposes of this example, refer to [Figure 1–9](#). A caller dials Extension 1234, a local extension on System B. Extension 1234 is assigned to a coverage group programmed as an integrated VMI group (Extension 7771 with one non-local member, extension 5528) as the receiver. The user at Extension 1234 is not available and the call is directed to integrated VMI calling group 7771. The systems checks the local dial plan then the non-local dial plan for the VMI calling group member extension (5528). Using UDP routing, the system absorbs the 4 dialed digits (5528) and prepends the digits 7771 (the extension for the centralized VMS/AA at the VMS hub) then routes the call over the PRI tandem trunks to the centralized VMS/AA.

If the caller leaves a message, the centralized VMS/AA sends signals over the signalling D-channel and the Message Waiting light at extension 1234 goes on. When the user at extension 1234 dials 7771 to reach the centralized VMS/AA to retrieve messages, the same routing takes place as before and when all messages are retrieved, the centralized VMS/AA sends signals over the signalling D-channel to turn off the Message Waiting light at Extension 1234.

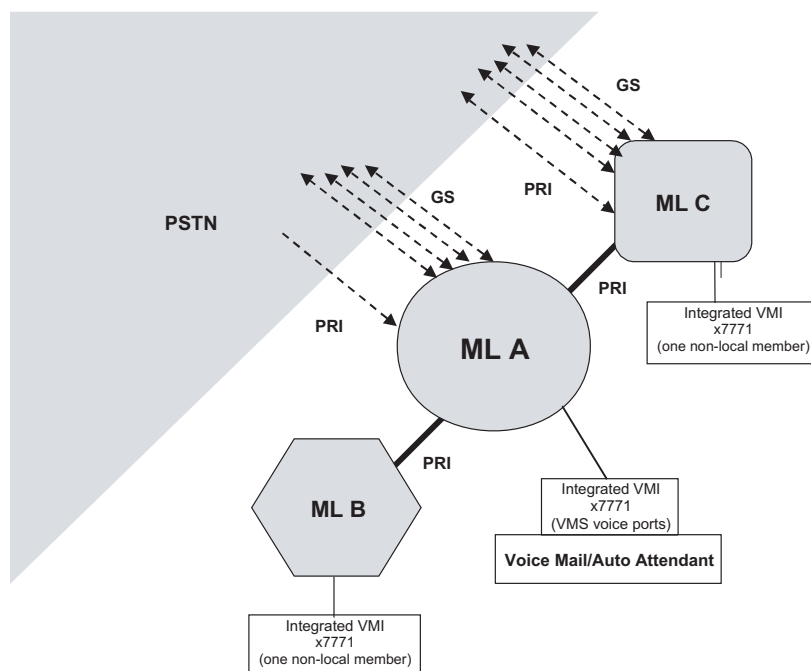

**Figure 1–9. Centralized Voice Mail with one VMS/AA for Entire Network**





**NOTE:**

It is recommended that PRI lines, rather than tie lines, be used between MERLIN LEGEND Communications systems in a private network that utilizes the Centralized Voice Mail feature. Refer to [Table 1-1, page 1-11](#) for advantages of PRI lines.

Because tandem switching allows intersystem coverage of calls to other systems on the private network, it is important to note that coverage to the centralized VMS/AA from remote private network systems must be limited to only one span. This means that a call may only pass through one tandem trunk to the centralized VMS/AA on the hub system.

It is also important to note that if a DEFINITY ECS or DEFINITY Prologix Solutions system is a networked system, it can not receive coverage to the centralized VMS/AA. Also, if the DEFINITY ECS or DEFINITY Prologix Solutions is the hub system in the star configuration, a centralized VMS/AA servicing connected MERLIN LEGEND Communications systems is not possible.

It is also possible to have more than one centralized VMS/AA on different hubs, and also have local VMS/AA systems attached to individual MERLIN LEGEND systems. However, each extension in the private network can have only one voice mailbox.

For Release 6.0 networks, Centralized Voice Mail is not available. Each system must have its own voice mail application for voice mail coverage. However, with Release 6.0, Version 11, calls can be routed over the private network from a centralized automated attendant.

## Networking Voice Messaging Systems

DEFINITY ECS and DEFINITY Prologix systems cannot share a MERLIN LEGEND system centralized VMS/AA, and MERLIN LEGEND systems cannot share a DEFINITY system VMS/AA. Networking voice messaging systems is an alternative that provides the appearance to users that everyone is sharing a single VMS.

Lucent Technologies messaging systems that support networking are Intuity AUDIX and Messaging 2000. Please see the messaging system documentation for more information about networking capabilities.

[Figure 1-10](#) shows a shared centralized VMS/AA used by MERLIN LEGEND Systems A and B networked to the VMS/AA system on DEFINITY System C.

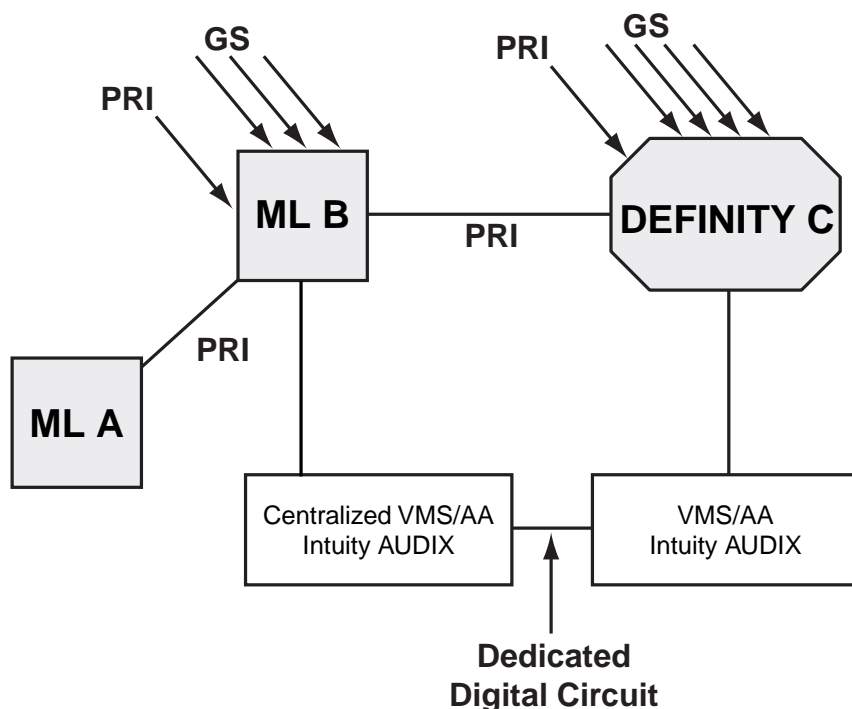

Figure 1-10. Networked Voice Mail Systems

## Call-Handling Scenarios

# 2

---

This chapter helps you plan and understand private network configurations. It includes the following two main topics:

- **Networking Guidelines.** This section describes the factors that you must consider when planning a private network or managing one or more systems in an existing private network.
- **Network Configuration Scenarios.** This section illustrates generally how systems can be set up and how calls can be made and received in several example private network configurations. "Scenario 2: Two Systems, Tandem Tie Facilities," provides a descriptive business example that helps you see how private network features work in a real-world business.

To help you plan further and understand your private network, Chapter 3, "Feature Interactions," summarizes the ways that features work in private networks. Security issues are discussed in depth in Chapter 4, "Security," and you should read this chapter in order to fine-tune such settings as Facility Restriction Levels (FRLs) for Automatic Route Selection (ARS), extensions, Uniform Dial Plan (UDP) ranges and routing, Remote Access, and extensions.

## Networking Guidelines

---

This topic outlines general planning and setup considerations for networked systems, providing the information that you need in order to understand the sample private network scenarios presented in the next section of this chapter. Security issues are discussed in greater detail in Chapter 4, "Security," and in Appendix A, "Customer Support Information."

When systems are networked, follow these guidelines in order to make implementation of private network features go smoothly. These guidelines are based on the assumption that you plan to use the features listed below. Therefore, a coordinating system manager to oversee network -affecting changes is recommended.

- **Non-local dial plan** for intersystem calling among extensions located on different systems on the private network
- **ARS dialing via private networked trunks** to allow users in one system to access the public switched telephone network (PSTN) facilities connected to one or more other networked systems
- **UDP routing** for intersystem calling and ARS use of tandem trunks

Whether you are working alone to manage multiple systems in a private network or working with others who manage other systems in a private network, the overall planning considerations affect all networked systems.

The following topics do not explain programming procedures or details of all system features that the sections reference. For detailed feature information, see the *Feature Reference*. For detailed programming procedures, see *System Programming*.

### Non-Local Dial Plan

---

System managers in a private network create non-local dial plans so that local system users can call extensions in remote networked systems. This *intersystem dialing* is transparent to system users; they dial these calls as though they were intercom calls, using System Access (**SA**) or Shared System Access (**SSA**) buttons. Chapter 5, "[Network Management](#)," includes information about such parameters as the valid number of digits, extension ranges, and patterns for programming non-local dial plans and routes.

A non-local dial plan consists of extension numbers for the following:

- Stations
- Adjuncts
- Listed Directory Number (LDN)
- Remote Access

When setting up your private network for intersystem calling, keep the following important points in mind:

- You cannot program the local ARS access code or pool dial-out codes into non-local dial plan extension ranges; the system blocks this programming. Non-local extension range numbers cannot begin with the local ARS access code. If, for example, the ARS access code begins with 9 and a non-local dial plan extension range is 9230–9330, programming is blocked. You must not program the ARS access code of a non-local system into the non-local dial plan because it poses a security risk; it is best if all networked systems assign the same ARS access code. For more information, see [“Automatic Route Selection \(ARS\)” on page 7](#).
- The Remote Access codes of non-local systems can be included in the non-local dial plan for the convenience of technicians for technical support or for users to program their forwarding home extensions on a non-local system. Each system should have a unique and unambiguous Remote Access code. For more information, see [“Remote Access” on page 8](#).
- Your non-local dial plan programming has no effect on the remote system(s) it references. Local dial-plan changes made at a system do not automatically update the non-local dial plan numbering plans of networked systems. To avoid misrouting, it is recommended that manual adjustments to the non-local dial plans made by private network system managers be made at the same time. System managers should provide ranges wide enough to avoid problems in future non-local dial plan changes.
- In most cases, the extension numbers programmed into the non-local dial plan should be the same extension numbers that users at remote systems dial in order to reach one another within their systems. The main exception occurs when non-local dial plan numbers refer to extensions on DEFINITY Enterprise Communications Server (ECS) or DEFINITY ProLogix Solutions systems, which include five digits. See [“Non-Local DEFINITY ECS or DEFINITY ProLogix Solutions Systems” on page 6](#) for details.
- Extensions included in ranges must be unique and *unambiguous* across systems. In other words, if the local system includes extension 112, that system blocks the programming of a non-local extension range that encompasses extension 1122. If it allowed the range, calls to 1122 would be misrouted because the system would send calls for extension 1122 to extension 112 as soon as it received the first three numbers. In this example, the local system prevents the numbering conflict. However, if the local system is connected to more than one other networked system, programmed extension ranges must assure proper routing. For example, if the manager on System A must program extension ranges on two connected systems, System B and C, the specified ranges on Systems B and C must be unique and unambiguous. If System B includes the range 2030–2049, System C cannot include an extension range that encompasses either extension 203 or extension 204.
- MERLIN LEGEND Communications System dial plans may include 2-digit, 3-digit, or 4-digit extension numbers. However, DEFINITY ECS or DEFINITY ProLogix Solutions users must dial four digits in order to reach a

MERLIN LEGEND Communications System extension in a private network. Although the MERLIN LEGEND Communications System can be programmed to drop digit(s), it is recommended that in networks with DEFINITY ECS or DEFINITY ProLogix Solutions use 4-digit dial plans. The next topic provides additional details.

- When planning non-local extension ranges, Primary Rate Interface (PRI) dial-plan routing and Direct Inward Dialing (DID) numbers must be considered. If calls are routed across the private network to these numbers, they also must not conflict with extension ranges in other private network systems. In addition, UDP routes must specify correct digit manipulation (deleting or adding digits). When such calls are routed to 5-digit DEFINITY ECS or DEFINITY ProLogix Solutions systems, special considerations apply. See the next topic for details.
- A centralized VMS/AA is subject to the following configuration requirements and constraints:
  - A DEFINITY ECS or DEFINITY Prologix *cannot* share a centralized VMS/AA with a MERLIN LEGEND system.
  - The hub system and all remote systems sharing a centralized VMS/AA must be MERLIN LEGEND Release 6.1 or later systems.
  - Each MERLIN LEGEND system must be configured as Hybrid/PBX.
  - Networked MERLIN LEGEND systems that are not directly connected to the “hub” system (more than one span away) cannot share the centralized VMS/AA.
  - More than one centralized VMS/AA can be configured in a single private network. More than one centralized VMS/AA can be installed on a single MERLIN LEGEND system.
  - Any MERLIN LEGEND system may also have a local VMS/AA system that is not shared.
  - Each extension in the system can have only one voice mailbox, no matter how many VMS/AA systems are available.
  - Only the following voice messaging systems are supported for centralized VMS/AA:
    - MERLIN LEGEND Mail
    - Messaging 2000
    - Intuity AUDIX
    - IS-III AUDIX Voice Power (no longer orderable)
  - A Uniform Dial Plan (UDP) must be established for the private network.
  - All trunks within the private network should have unique trunk numbers. This allows the centralized VMS/AA to provide different call handling and/or greetings based on the trunk on which the call was received.

- No more than three (3) analog spans should be involved in any call or volume levels may not be adequate. Multiple spans may be the result of transfers and coverage. If more than three spans may be involved in call completion, digital rather than analog spans should be used.
- Sending overflow or coverage calls to a centralized VMS/AA may add unanticipated traffic to a private network. A call transferred from one system to another and then sent back by overflow or coverage occupies two trunks. The MERLIN LEGEND system does not provide release link operation when a call through the private network returns to the originating system.
- Pools within a UDP route cannot mix PRI and tie tandem trunks. The type of signaling is based on the first trunk in the pool, and will not work correctly for subsequent trunks if they are not the same type.
- If tandem tie trunks are used, Touch Tone Receivers (TTRs) are required for each call over the tie trunks including voice calls, coverage calls, and Message Waiting light updates. These calls go both directions, so TTRs are required at both ends.
- Centralized VMS/AA is implemented using the Group Calling enhancement and UDP routing. Integrated VMI calling groups are defined on the hub system and each remote system. The integrated VMI calling group on the hub system contains the voice messaging system ports. The integrated VMI calling groups on each remote system receive overflow, coverage, and voice mail retrieval calls and route them to the integrated VMI group on the VMS hub system.
- Routing to the centralized VMS/AA is done by assigning a single non-local extension as a member of the integrated VMI calling group at each remote system sharing the centralized VMS/AA. From the user's point of view, the routing is transparent. The user dials the same extension number from any location in the private network to reach the voice messaging system. This extension has no corresponding physical extension and is referred to as the *VMI conversion number* in this guide.



**NOTE:**

The VMI conversion number should not be published. This prevents users from dialing the VMI conversion number to retrieve messages, which can result in improper operation of the VMS/AA application.

- A PassageWay Telephony Services application may use the length of ANI/ICLID information to differentiate outside calls from inside calls. Some businesses can set up their PBX to send only a 4-digit number for ANI/ICLID information. For Release 6.0 and later systems, a call with less than 5 digits appears as a private network call.
- If a PassageWay Telephony Services application uses the presence of a trunk identifier to differentiate inside and outside calls, a non-local dial plan call displays as an outside call. The display depends upon the application.

## Non-Local DEFINITY ECS or DEFINITY ProLogix Solutions Systems

DEFINITY ECS and DEFINITY ProLogix Solutions communications systems can support either 4- or 5-digit dial plans. However, 5-digit extension ranges cannot be programmed into a MERLIN LEGEND Communications System non-local dial plan. With possible extension numbering conflicts in mind, handle 5-digit extension numbers by using one or both of the two methods explained below.

- Program the *first* four digits of the extension number ranges into the non-local dial plan, for example 1234–1236 for remote extensions 12340–12369. Because ranges are programmed and not necessarily individual extensions, this may not present problems. However, this method does not work when you need to stipulate ranges of fewer than ten numbers. Aside from this consideration, this method is usually the better of the two techniques. Users dial 5-digit extension numbers to reach non-local users at DEFINITY ECS or DEFINITY ProLogix Solutions systems, and they dial the same extension numbers as the DEFINITY ECS or DEFINITY ProLogix Solutions users do within their own system. A MERLIN LEGEND Communications System consults the non-local dial plan to route, based on the first four digits, but sends the fifth digit to the DEFINITY ECS or DEFINITY ProLogix Solutions system for handling. [“Scenario 5: Large System Hub” on page 88](#) provides an example.

For Release 6.0 systems earlier than Version 11, when this method is used, a MERLIN LEGEND Communications System user must dial the fifth digit of a non-local DEFINITY ECS or DEFINITY ProLogix Solutions extension number within two seconds of dialing the fourth digit.

For Release 6.0, Version 11 and later systems, programming the number of dialed digits as 5 makes this restriction unnecessary and speeds call setup time.

- Program the *last* four digits of the extension number ranges into the non-local dial plan, for example 2340–2369 for extensions 12340–12369. Then, when you assign UDP routes to the patterns, program the number of dialed digits as 4 (Release 6.0 Version 11 and later system only), and use the Other Digits system programming setting to prepend the first digit, which in this example is a 1. If it is necessary to route PSTN Direct Inward Dialing (DID) or PRI dial-plan routed calls through a MERLIN LEGEND Communications System to a DEFINITY ECS or ProLogix Solutions system with 5-digit numbering, you must use this method.



### NOTE:

It is best to connect DID trunks directly to DEFINITY ECS or DEFINITY ProLogix Solutions systems instead of MERLIN LEGEND Communications System for local routing.

In larger private networks, the second method may cause more numbering conflicts than the first method. You must consider the second digit(s) of DEFINITY ECS or DEFINITY ProLogix Solutions extension numbers to avoid confusion and ambiguity. Extensions 12345 and 2345, for example, are ambiguous when the 1



must be prepended. Furthermore, users on your system dial only four digits to reach remote extensions while DEFINITY ECS or DEFINITY ProLogix Solutions users dial five digits for intercom calls within their local systems, so extension numbering is not consistent across the private network.

When a private network includes a DEFINITY ECS or DEFINITY ProLogix Solutions system, it is recommended that the MERLIN LEGEND Communications Systems in the private network use 4-digit extension numbers in their local dial plans. One reason is that DEFINITY ECS and DEFINITY Prologix Solutions systems cannot dial anything less than a 4-digit extension number. If a DEFINITY ECS or DEFINITY ProLogix Solutions system is the hub and uses 5-digit extension numbers, calls can be more easily routed through it to reach MERLIN LEGEND Communications System extension numbers that are four digits long. If the MERLIN LEGEND Communications System extension numbers are three digits long, there are more potential numbering conflicts. For example, if a MERLIN LEGEND Communications System extension number range is 220–249, it can conflict with a very large range of DEFINITY ECS or DEFINITY ProLogix Solutions system extension numbers, 22000–24999. Furthermore, 4-digit numbering provides more room for growth and for easy routing to different types of extensions in a MERLIN LEGEND Communications System, without the need for system renumbering of the local dial plan.

When planning for centralized VMS/AA, keep in mind that the DEFINITY ECS and DEFINITY ProLogix Solutions systems cannot send coverage or overflow calls to a VMS/AA on a MERLIN LEGEND system, and a MERLIN LEGEND system cannot send coverage or overflow calls to a DEFINITY system's VMS/AA. The automated attendants on both systems can transfer calls to extensions on the other system. The position of the DEFINITY system within the private network may also affect the ability of MERLIN LEGEND systems to use a centralized VMS/AA. Only a MERLIN LEGEND system directly connected by tandem trunks to the MERLIN LEGEND system where the centralized VMS/AA is installed can send calls to the centralized VMS/AA.

## **Automatic Route Selection (ARS)**

---

Local system users may use ARS to route calls over tandem trunks to the PSTN facilities connected to a remote system.

This arrangement can provide toll cost savings when users need to reach outside numbers that are *not* in their own local calling area but *are* local to other systems in a private network. It also means that in some cases, a MERLIN LEGEND Communications System may have only one or two PSTN trunks connected to it for emergency purposes only. Under normal circumstances, the system uses PSTN facilities connected to another system in the private network, which can provide call-volume advantages when buying PSTN services such as domestic long-distance calling. The scenarios later in this chapter provide examples.

The following general rules make ARS routing both simpler and safer:

- **Common Access Code.** For proper handling of calls across the private network, all systems in the private network should use the same ARS access code. Using a common ARS code across the private network provides ease of use for users travelling between sites, and also ensures completion of Dial 0 and 101xxxx equal access code calls.
- **Security.**
  - The ARS non-local access code *must not* be programmed into the non-local dial plan, as mentioned earlier in this section.
  - It is the responsibility of the switch where ARS calls originate to prevent toll fraud.
- **Co-located Network Switches.** When two or more systems are located at the same street address, and one of the systems does not have PSTN trunks connected, some tandem trunks from that system must be assigned to the default pool and all ARS tables (including Table 17, 18, Dial 0, and Special Numbers tables) must prepend the ARS code for the co-located private network system. This will assure that 911 calls will be routed properly and that the correct calling address will be identified.

Additional information about ARS security is included in Chapter 4, "Security."

## Remote Access

---

When non-local users access ARS to dial out over PSTN facilities connected to your local system or to another system connected to yours, your system uses a special form of the Remote Access feature to accommodate these calls. Because calls are routed from one system to one or more other systems, the remote access settings for this purpose are distinct from the Remote Access feature used by individuals who enter a barrier code in order to reach an extension or place an outgoing call on the system.

The remaining topics provide additional details about programming remote access in private networks.

## Programming Remote Access over Tandem Trunks

Non-local users who access your PSTN trunks via ARS and private network trunks do not dial a remote-access barrier code. For security purposes, the system applies the default class-of-restriction (COR) calling restrictions that you assign to all tie (T1-emulated voice or data, or analog) or non-tie (PRI) trunks, ignoring the barrier code requirement setting. If remote users connect to your system via tandem PRI facilities, the non-tie restrictions apply; otherwise, the tie restrictions apply. You can program both types of COR if needed, using the following system programming procedure (refer to *System Programming* guide for detailed instructions).

SYS PROGRAM→LINES/TRUNK→REMOTE ACCESS→NONTIE/TIELINES→  
RESTRICTIONS

When programming the default COR, change the Calling Restriction option to unrestricted (the factory setting is outward restricted). You should assign Disallowed List 7 to include; 900, 976, and other types of calls that users should not be allowed to call. When a call is received at a non-local system that routes it to another private network system, the FRL assigned to the default COR is compared to the local UDP or ARS route FRL to permit or forbid the routing of the call. For a call to go through, the route FRL must be equal to or less than the default COR FRL. These considerations are discussed in detail in Chapter 4, "Security."

To make it easier for users working away from their home system in a private network and for maintenance and toll-saving purposes, you can include non-local systems' Remote Access codes in your non-local dial plan. Each networked system should have a unique, unambiguous Remote Access code. These numbers must not conflict with extension ranges in the networked systems' non-local dial plans. Calls to the remote access extension that require barrier codes use the COR assigned to the barrier code entered.



### SECURITY ALERT:

*Networked systems require special attention to security issues. Follow the rules below when setting up and planning your system for private network use.*

- *Ensure that barrier codes are required for incoming remote access calls received on PSTN dial-plan routed and tandem facilities that route to the Remote Access code (889, for example). When you program the default COR, turn the barrier code requirement on. This setting is ignored for ARS calls and calls to non-local extensions across the private network. However, it is still applied to DID and PRI dial-plan routed remote access calls as well as to calls received on a tandem trunk and routed to a Remote Access code. Because the COR Calling Restriction must be set to unrestricted for private network calling, using barrier codes on these facilities is essential in order to apply security measures. When a Remote Access code is included in the non-local dial plan of the calling system, the caller's barrier code FRL on the called system is compared to the UDP or ARS route FRL on the called system. See the Feature Reference and ["Remote Access Default Class-of-Restriction Settings"](#) on page [6](#) for details.*
- *Extension and ARS FRLs should be carefully and stringently assigned in order to prevent unauthorized trunk-to-trunk transfers to local PSTN facilities. [Table 4-1, page 4-3](#) explains the operation of this feature in a networked system.*

## Programming Regular Remote Access

For explicit remote access use by local system users (or by non-local users for special maintenance purposes, for example), assign PSTN trunks to remote access as you normally would, or use PRI dial-plan routed or DID trunks. Specify that users *must* enter barrier codes for remote access. Do *not* assign tandem trunks as dedicated or shared remote-access facilities.

## Tandem Trunks

---

As Chapter 1, "Introduction," explains, tandem trunks may be either PRI or tie facilities. ["Scenario 1: Two Systems, Tandem PRI Facilities" on page 16](#) explains the advantages of PRI tandem trunks, which provide enhanced features and performance over tie trunks. Tandem T1-emulated tie trunks provide faster call setup and greater data speeds than analog tie trunks, although they do not provide the full functionality of PRI. Analog tandem tie trunks may be required in some private networks where the systems cannot support additional PRI or T1 facilities and remain within the 80-line capacity of a MERLIN LEGEND Communications System. For examples, see ["Scenario 3: Four Systems in a Series, Mixed Facilities" on page 57](#) and ["Scenario 4: Four Systems in a Star, Mixed Facilities" on page 74](#).

In Release 6.1 and later systems, when planning for centralized VMS/AA, PRI tandem trunks also provide faster Message Waiting light operation and the ability for the centralized VMS/AA to determine whether calls originated on inside or outside lines.

System managers must assign switch identifiers to designate, for each networked trunk, the type and distance of the system connected to the other end of that trunk. The identifiers serve several purposes: they assure the proper volume levels on private network trunks and allow the proper routing for calls across the private network. For example, if System A is connected to System B by a tandem trunk, on System A that trunk must be programmed with the switch identifier for System B, the system at the other end of the tandem trunk. Similarly, on System B that trunk must be programmed with the switch identifier for System A.



### NOTE:

The switch identifier is not programmed on the system that it identifies, but is programmed on the tandem trunks of other systems connected directly to it.

The number range of a switch identifier designates both the type of system connected at the other end of a tandem trunk and the distance between the systems in order to assure proper volume levels for calls (see ["Scenario 4: Four Systems in a Star, Mixed Facilities" on page 74](#) for an example). The distance is expressed as *satellite* (*near*) or *non-satellite* (*far*) to designate systems closer than 200 miles or further than 200 miles, respectively. A MERLIN LEGEND Communications System is always identified by a number between 1 and 20 for

far (over 200 miles) connections and between 21 and 40 for near (under 200 miles) connections. DEFINITY ECS and DEFINITY ProLogix Solutions systems are identified by numbers between 41 and 50 for far connections and between 51 and 60 for near connections.

With a given private network system, all the trunks that connect to another specific system must have the same switch identifier number. For example, if two T1-emulated tie trunks connect System B to System A, System A's manager must ensure that both of those tandem tie trunks are labelled with the same switch identifier, which is different from the switch identifier that labels a third trunk connecting System A and System C.

It is strongly recommend that each system have a unique pair of identifiers for far and near. If the switch identifiers are not correctly programmed, routing is disrupted. For example, when the switch identifier of the incoming trunk and the automatically selected outgoing trunk for a call match, another route for the call is selected if possible. However, if all available routes specify systems with matching switch identifiers, the caller hears a fast-busy tone. Otherwise, the call would be routed back to the originating system in a continuous loop. This is called *automatic immediate cycling*.

A trunk that is not a tandem trunk has no switch identifier; this is the factory setting for all trunks. This is how the switch distinguishes tandem trunks from central office lines. To remove a switch identifier, see ["Switch Identifiers" on page 19](#).

PRI tandem trunks require special programming, much of which is automated for you when a PRI switch type of MERLIN LEGEND-PBX or MERLIN LEGEND-Ntwk is chosen. The switch type for the system *at the other end* of a PRI tandem trunk is selected during system programming. When MERLIN LEGEND Communications Systems are networked, the switch types at each end of a tandem PRI trunk are different. The scenarios provide examples. See ["Tandem PRI Facilities" on page 22](#) for details.

In Release 6.1 and later systems, the PRI Switch Type Test requests the system at the other end to verify that the correct PRI switch type is programmed. This test should be run only by Lucent Technologies technicians or authorized representatives.

In Release 6.0, outside PRI dial-plan routed and DID calls can be routed to non-local extensions. In Release 6.1 and later systems, this capability has been expanded to all types of PSTN trunks by using calling groups with a single non-local member. Most of the scenarios in this chapter provide examples.

## Security

---

This topic summarizes security issues that are discussed in more detail in Chapter 4, "Security."

Some security issues have been mentioned in the previous topics, including the reasons that ARS codes are not included in the non-local dial plan. In addition, keep the following considerations in mind:

- The ARS access code is permitted only for incoming calls on private network trunks. It is blocked from incoming PSTN calls.
- All tandem trunks must be assigned to pools and each pool must contain the same types of trunks.
- Users must not be given dial access, **Pool** button access, or DSS button access to pools of networked trunks. Instead, they use these facilities via UDP and/or ARS calling. Routing details are included in the scenarios later in this chapter.
- Despite the trunk-to-trunk transfer restriction, a person using any type of telephone can transfer the following types of calls:
  - A call on a tandem trunk transferred to a non-local dial plan extension
  - A call on an outside PSTN facility transferred to a non-local dial plan extension
  - A call on a tandem trunk transferred to an outside PSTN line/trunk

However, if an extension is prohibited from making trunk-to-trunk transfers, the user cannot transfer an outside call on a PSTN trunk to another PSTN trunk.



### SECURITY ALERT:

*An outside call can arrive at an extension on a private network system (System A) and be transferred to an extension on another private network system (System B). The person receiving the transfer on System B can then transfer the call to a local PSTN trunk despite any restrictions that are in effect.*



### NOTE:

PassageWay<sup>®</sup> Telephony Services clients cannot perform transfers across the private network. Instead, the users must transfer calls using a telephone. For an example, see ["Scenario 5: Large System Hub" on page 88](#).

- Calling restrictions such as Toll and outward restrictions, Allowed/Disallowed Lists for extensions, and Night Service restrictions are not applied to UDP calls. Only the extension's FRL can block completion of UDP calls.

- UDP routing applies FRLs to calls over specific routes for pools of tandem trunks. A different set of FRLs is programmed for ARS routes. However, an extension's FRL applies to *both* UDP routes and ARS routes. An extension's FRL is applied only to local tandem and PSTN calls and is not carried across the private network when the caller uses ARS to direct a call to PSTN facilities on another switch. As you read the scenarios in this chapter, pay attention to the following rules:
  - Within a system, ARS FRL restrictions compare the local extension FRL to the route FRL. To use a route for a call, the extension FRL must be equal to or greater than the route FRL.
  - For intersystem calling, the system compares the local extension FRL to the UDP route FRL. To use a route for a call, the extension FRL must be equal to or greater than the UDP route FRL.
  - When a Remote Access code is included in the non-local dial plan of the calling system, the caller's barrier code FRL on the called system is compared to the UDP or ARS route FRL on the called system.
  - When a UDP or ARS call is routed into a system over tandem trunks and then out of it again, the FRL assigned to the default COR for all-tie or all non-tie trunks is compared to the FRL assigned to the outgoing UDP or ARS route on the called system. The default COR's FRL must be greater than or equal to the FRL of the outgoing route on the called system.
  - When a PRI dial-plan routed or DID call is routed across systems in a private network, the system receiving the call from the PSTN searches the local dial plan and then the non-local dial plan for the destination extension number. If the number is in the non-local dial plan, the call is routed out using the UDP routing pattern for the specified extension range. For a call to be routed out of the *next* receiving system, that system's COR FRL must be equal to or greater than the UDP route FRL.
  - In Release 6.1 and later, when an integrated VMI calling group is used for routing calls to a centralized VMS/AA, assign an FRL of 0 to the UDP route for the VMI conversion number. The pattern for the VMI conversion number should not be used for any other routing.



### SECURITY ALERT:

*Networked systems require special attention to security issues. Follow the rules below when setting up and planning your system for private network use.*

- *Ensure that barrier codes are required for incoming remote access calls received on PSTN dial-plan routed and tandem facilities that route to the Remote Access code (889, for example). When you program the default COR, turn the barrier code requirement on. This setting is ignored for ARS calls and calls to non-local extensions across the private network. However, it is still applied to DID and PRI dial-plan routed remote access calls as well as to calls received*

on a tandem trunk and routed to a Remote Access code. Because the COR Calling Restriction must be set to unrestricted for private network calling, using barrier codes on these facilities is essential in order to apply security measures. When a Remote Access code is included in the non-local dial plan of the calling system, the caller's barrier code FRL on the called system is compared to the UDP or ARS route FRL on the called system. See the Feature Reference and "[Remote Access Default Class-of-Restriction Settings](#)" on page [6](#) for details.

- *Extension and ARS FRLs should be carefully and stringently assigned in order to prevent unauthorized trunk-to-trunk transfers to local PSTN facilities. [Table 4-1, page 4-3](#) explains the operation of this feature in a networked system.*

Chapter 4, "Security," explains FRLs and how they affect routing in more detail.

## Network Configuration Scenarios

---

In this topic, the networking scenarios are distinguished by the types of facilities that connect the systems, geographic locations of the systems, the PSTN facilities connected to each system, the arrangement of the systems in a series or in a star, and the number of systems included in the private network. The following examples are discussed:



### NOTE:

Centralized Voice Mail is available for Release 6.1 and later systems only. For Release 6.0 systems, disregard the centralized VMS/AA capability in the following topics. Each system must have its own voice mail application.

- **Scenario 1: Two Systems, Tandem PRI Facilities, [page 16](#).** In this example, two MERLIN LEGEND Communications Systems are linked in a private network using PRI tandem trunks only. This is a *series configuration*. The systems are located in different area codes, and each has public-switched network trunks connected to its local system. Each also shares a centralized VMS/AA located at one of the systems. (Release 6.1 or later is required on both systems.) This scenario also illustrates the use of tandem PRI trunks and how they provide greater functionality in private networks than do tandem tie trunks.
- **Scenario 2: Two Systems, Tandem Tie Facilities, [page 32](#).** In this example, two MERLIN LEGEND Communications Systems are linked in a private network using tandem tie trunks only. This is also a series configuration. The systems are located in different area codes, and each has public-switched network trunks connected locally. Each also shares a centralized VMS/AA located at one of the systems. (Release 6.1 or later is required on both systems.) To show how private networks work in a business environment, this scenario provides more details about real-world



organizational needs and overall feature planning. This scenario also illustrates the way systems work when they are connected by tandem tie trunks only.

- **Scenario 3: Four Systems in a Series, Tandem PRI Facilities, [page 57](#).** In this scenario, there is no hub system. Instead the systems are connected in a linear fashion. Three systems are joined by tandem PRI facilities. A fourth system is connected to one of the others by analog (E&M) tandem tie trunks. One of the systems has its own VMS/AA and the other three share a centralized VMS/AA. The system with the centralized VMS/AA is also called the VMS hub. (Release 6.1 or later is required for all systems sharing the centralized VMS/AA.)
- **Scenario 4: Four Systems in a Star, Mixed Facilities, [page 74](#).** In this scenario, one system acts as the hub and has public-switched network trunks connected to its control unit, as do two other systems connected in a *star configuration* to the hub. The fourth system has only emergency PSTN trunks connected locally and normal calls are made using PSTN facilities connected to other systems. The systems are linked both by PRI and analog (E&M) tandem tie facilities. All of the systems share a centralized VMS/AA. The system with the centralized VMS/AA is also called the VMS hub. (Release 6.1 or later is required for all systems.)
- **Scenario 5: Large System Hub, [page 88](#).** In this scenario, two MERLIN LEGEND Communications Systems are linked to a hub DEFINITY ECS or DEFINITY ProLogix Solutions system in a star configuration. Because this star configuration has a DEFINITY ECS or DEFINITY ProLogix Solutions system as the hub, it is not possible to configure a centralized VMS/AA.

**NOTE:**

DEFINITY ECS and DEFINITY ProLogix Solutions features and operations are beyond the scope of this guide. Scenario 5 discusses the private network from the MERLIN LEGEND Communications Systems perspective.

The scenarios vary according to the types of tandem trunks, applications, outside facilities, and private network configuration (series or star). They compare and contrast the following aspects of private networks, supplying both usage and setup information:

- Intersystem call-handling to and from extensions on remote networked systems
- ARS routing and calling via PSTN trunks connected to a remote networked system
- ARS routing and usage when local PSTN trunks are accessed by non-local users
- Remote access planning for non-local users calling out on local PSTN facilities

- Remote access planning for private network usage by people who are calling in either from outside the private network or from an extension that is non-local to their home system
- PRI dial-plan routed and DID calling across the private network
- UDP routing for centralized VMS/AA
- Considerations for PassageWay Telephony Service clients using the system's Computer Telephony Integration (CTI) link feature

The scenarios in this section do not show all of the types of equipment, such as fax machines and single-line telephones, that may be included in systems. They only include the types of equipment that are relevant to the examples. You can use the same types of extension equipment in a networked system that you use in a non-networked system.

To better understand your current system, review Scenario 1 if your private network includes *any* tandem PRI trunks; review Scenario 2 if your system includes *any* tandem tie trunks. Then review the remaining scenario that is most like your own. When you are planning private network changes, review one or more of the scenarios that involve system components and facilities for which you are planning. Even though your own private network may not be represented here exactly as it exists, information in a scenario that describes a similar configuration, application, or facilities can be helpful to you.

If you are planning for a private network using Release 6.0, disregard the information about centralized VMS/AA.

### **Scenario 1: Two Systems, Tandem PRI Facilities**

---

In this scenario, two MERLIN LEGEND Communications Systems are connected in a series configuration via tandem PRI trunks, which provide the best support for features, call-handling displays, centralized VMS/AA, and performance across private networks.

In this private network, the two system managers work closely together and maintain copies of system forms for both systems. If changes must be made, they first discuss them and assess their impact on the private network.

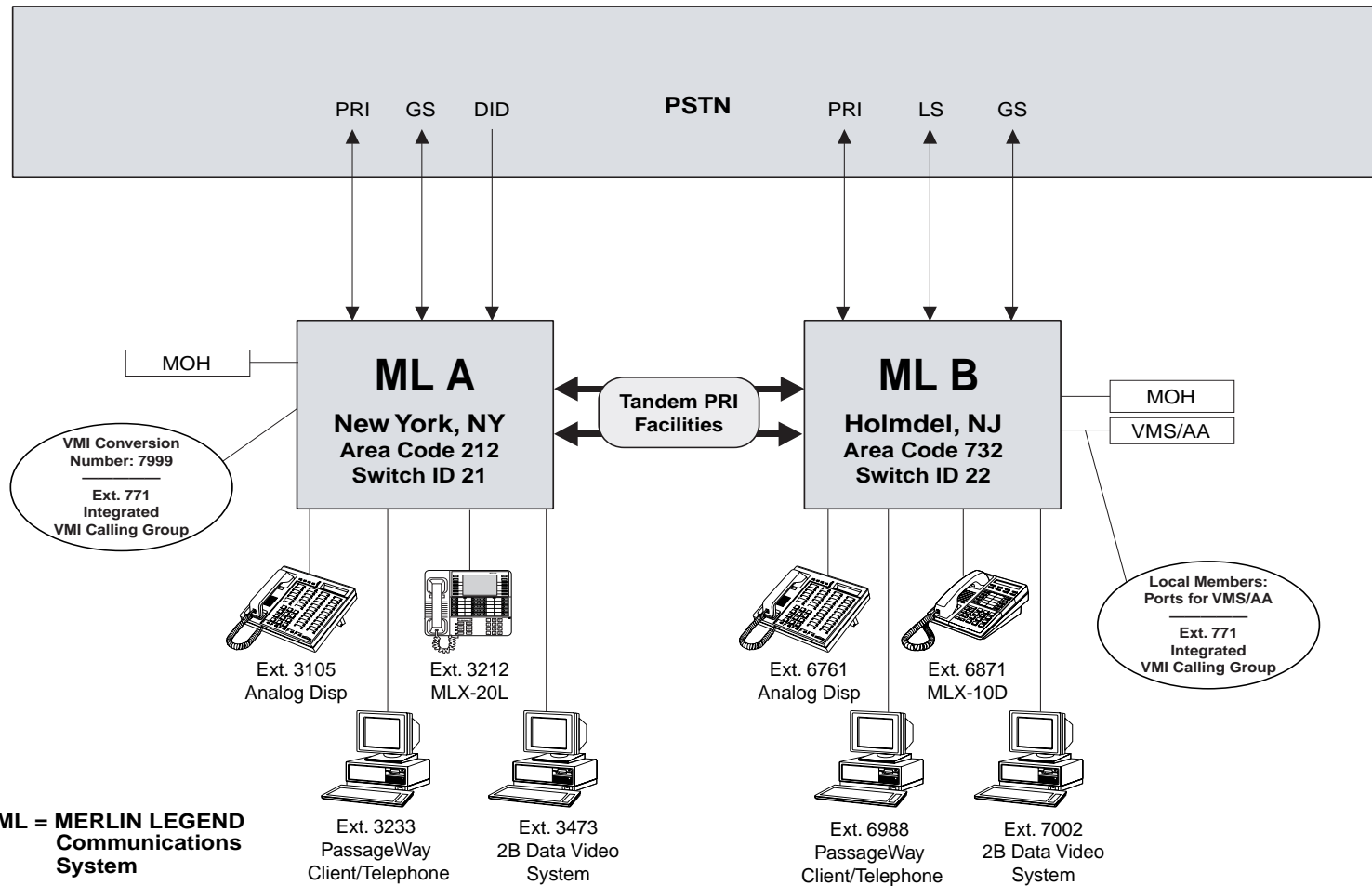

Figure 2-1. Scenario 1: Overview

Tandem PRI trunks provide the following benefits:

- **Faster General Performance.** PRI facilities make faster connections across private networks for ARS calling over tandem trunks as well as faster intersystem call handling.
- **Faster Data Transmission.** Networked PRI tandem trunks support digital data speeds of up to 128 kbps between networked systems for enhanced 2B data videoconferencing and other data applications. Earlier releases permitted a maximum speed of 112 kbps between connected systems.



**NOTE:**

If you plan to communicate at 64 or 128 (2B data) kbps, use extended superframe (ESF) format with Bipolar 8-Zero Substitution (B8ZS) line coding. Some service providers charge more for this type of T1 circuit. However, it not only allows the higher speed, it is also less susceptible to line errors than other format and coding combinations and can be maintained without taking the facility out of service.

- **Better Call-Handling Displays.** Intersystem calls via networked PRI facilities can provide the caller's extension label (for example, caller name), extension number (factory setting), or both name and number at the recipient's MLX telephone display. Scenario 1 shows the details for different types of telephones.
- **Lower Service Provider Costs.** When you use PRI over a private network, you order a point-to-point T1.5 circuit from your service provider, then program the PRI service yourself rather than leasing it from the service provider. When networked systems are distant, the service provider may need to provide amplification but not PRI switching services.
- **Fractional Use Support.** You may place drop-and-insert equipment between systems connected by a PRI tandem trunk, allowing use of fewer than 23 B-channels. The dropped channels are generally used for dedicated data/video service, and the remaining channels carry voice traffic. The equipment must never drop Channel 24, the D-channel. All channels do count towards the system maximum of 80 lines.
- **Automatic Number Identification (ANI)/Incoming Call Line Identification (ICLID).** If PRI tandem trunks are used, ANI and ICLID information may display at the destination extension.
- **Better Transfer Handling.** When a user manually transfers a call across the private network on tandem PRI trunks and the transfer recipient's extension is either busy or has turned on Do Not Disturb and has no coverage available, the call returns to the transfer originator. If a call is transferred over tandem tie trunks, or is transferred with automatic completion over tandem PRI trunks, it does not return to the originator when the intended destination is unavailable.

- **Faster Message Waiting Light Updates.** For centralized VMS/AA systems in Release 6.1 and later, PRI tandem trunks allow Message Waiting light updates to be sent over the signalling D-channel. With tie tandem trunks, Message Waiting light updates compete with other voice and data traffic for available trunks and touch tone receivers. As a result, Message Waiting light updates may be delayed.

[Figure 2–1 on page 2–17](#) shows some PSTN facilities and PRI tandem trunks in a hypothetical private network that includes two MERLIN LEGEND Communications Systems sharing a centralized VMS/AA. A few extensions are shown so that the scenario can demonstrate how calls are handled and how they display at different types of extension equipment. Sample PSTN facilities are shown to illustrate routing when non-local callers use them or when outside calls are transferred or routed across the private network.

Note the following general facts about this small private network:

- Both systems share a centralized VMS/AA located on System B. This might be, for example, a MERLIN LEGEND Mail application.
- When a caller leaves a message or when a non-local subscriber retrieves all messages, the centralized VMS/AA sends the Message Waiting light updates over the PRI D-channel. If all available PRI tandem facilities are out of service when Message Waiting light updates are attempted, the updates are queued behind any other earlier queued updates and are retained on the central system until a PRI facility is returned to service. Message waiting light updates cannot be sent through the PSTN.
- The two systems are located in different area codes in the same large Mid-Atlantic metropolis. They are not, however, geographically distant or in different time zones. For the purposes of this example, it is assumed that both systems activate Night Service mode at the same time and night service calls are routed to the centralized VMS/AA on System B.
- ARS can be used to route calls over tandem trunks to another system and then out to the PSTN trunks connected to that other system. For example, if a user on System A needs to reach an outside party in the 732 (Holmdel, NJ) area code, the call goes over tandem PRI facilities and then to the PSTN through an outside facility connected to System B; if a user on System B needs to reach an outside party in the 212 (New York, NY) area code, the call goes over tandem PRI facilities and then to the PSTN through an outside facility connected to System A. When the preferred routes are used, toll savings are optimal.
- Coverage for extensions or calling groups on remote systems can be accomplished by sending overflow or coverage to an integrated VMI calling group consisting of a single non-local extension referred to as the “VMI conversion number.” The call is sent over the PRI tandem trunks to the centralized VMS/AA and includes call information signals that indicate whether the call originated as an inside or outside call. When the caller leaves a voice mail message, the centralized VMS/AA sends the Message Waiting light update over the signalling D-channel to the extension at the remote system.

## Non-Local Dial Plans and Facilities Planning

This section shows how non-local dial plans, calling groups, switch identifiers, UDP routing, ARS routing, and remote access are set up for each system. Not all details are provided for all facilities and extensions.

[Table 2-1, page 2-22](#) shows some applicable extension ranges, patterns, and routes for pools when people in one system call people at non-local extensions. For each route, there is a pool number, an FRL, and assignment of voice and/or data service. Digit manipulation is required for routes that use PSTN trunks, which are assigned high-numbered FRLs and are available to only a few users. Digit manipulation is also required for routing coverage or calling group overflow calls to the centralized VMS/AA. Reserved pools are assigned for high-speed 2B data calls, which must not be queued using the Automatic Callback feature. Restrictive FRLs are unnecessary for these routes, because they are for data only and cannot be used for voice calls.



### NOTE:

Pools for voice only calls on PRI tandem trunks should not include data trunks. System Alarms will result if voice extensions try to access data trunks. If PRI tandem trunks carry voice and data calls, "voice/data" should be assigned as the route attribute.

In this example, voice calls over tandem trunks to the non-local system are permitted for all users. When all private network routes are unavailable, voice users can employ Automatic or Selective Callback feature to queue for Route 1. To ensure that high-priority callers are not waiting too long for tandem trunks to become available, split the tandem trunks into separate routes with different FRLs.

The Remote Access code for each system is unique and unambiguous, so that users from one system can make lower cost remote access calls into the other system for technical support reasons or for changing forwarding options at their home extensions on remote systems. Users must enter barrier codes in order to make these remote access calls into the non-local system via the non-local dial plan. Their barrier code FRLs must permit the remote access calls using the UDP routes.

[Table 2-2, page 2-24](#) shows how the system managers set up their local systems so that users on the other system can access their local PSTN facilities. It also illustrates how they allow local users to access PSTN facilities on the other system. [Table 2-3, page 2-25](#) summarizes the key points about routing for calls originating in the private network systems. As you review the tables, note the following rules:

- Local ARS routing analyzes the initially dialed digits to determine whether a call can be handled more economically using local or non-local PSTN lines/trunks.

- If a call should be routed over a non-local system for toll-saving purposes, the local ARS routing directs it to a tandem PRI trunk pool, prepending the ARS access code. Local PSTN pools are only used as a fallback option, and more restrictive, higher-numbered FRLs are assigned to these ARS routes. Voice extensions can use the Automatic or Selective Callback feature to queue for the first route when other routes are either busy or unavailable because of FRL restrictions.



**NOTE:**

Even though the ARS access codes for the two systems match, calls with area codes defined in ARS that are routed via private network trunks still require prepending of the non-local system's ARS code. The prepended ARS access code signals the non-local system to handle the call using ARS.

- Local FRL extension restrictions apply to local ARS calls. Before a call is routed over tandem trunks, the FRL for that tandem trunk route is checked against the call originator's extension FRL. The non-local system's ARS feature subsequently analyzes the call for routing by comparing the FRL for the default COR for non-tie trunks (tandem PRI) with the FRL assigned to the local ARS route. The default COR FRL is set to 3. The route FRL must be equal to or lower than 3 in order for the call to go through.
- In Release 6.1 and later systems, when planning for centralized VMS/AA, an integrated VMI calling group must be created at System A. This integrated VMI calling group is used to route calls to the centralized VMS/AA installed on System B. Refer to "Implementation of Centralized VMS/AA" in Chapter 5 for implementation details.

Table 2-1. UDP Extension Ranges: Scenario 1

---

<b>System A Local Dial Plan: 3100–3299; 3400–3499</b>	<b>System B Local Dial Plan: 6700–7199</b>
<b>Remote Access Code: 889</b>	<b>Remote Access Code: 122</b>
<b>Integrated VMI Calling Group for Routing to Centralized VMS/AA: 771</b>	<b>Centralized VMS/AA: 771</b>
<b>Trunks: 3801-3880</b>	<b>Trunks: 8001-8080</b>
<hr/>	
<b>Extension Range: 6700–6799, Pattern: 01</b>	<b>Extension Range: 3100–3199, Pattern: 01</b>
Route 01 Pool=3360, tandem PRI trunks FRL=0, Voice	Route 01 Pool=4420, tandem PRI trunks FRL=0, Voice
Route 02 Pool=3365, tandem PRI trunks FRL=3, Voice	Route 02 Pool=4423, tandem PRI trunks FRL=0, Both
<hr/>	
<b>Extension Range: 6800–6999, Pattern: 02</b>	<b>Extension Range: 3200–3299, Pattern: 02</b>
Route 01 Pool=3364, tandem PRI trunks FRL=0, Both	Route 01 Pool=4422, tandem PRI trunks FRL=0, Both
Route 02, PSTN trunks Pool=3367, FRL=6, Voice No dialed digits are deleted and one plus the area code and exchange are prepended.	Route 02, PSTN trunks Pool=4424, FRL=6, Voice No dialed digits are deleted and one plus the area code and exchange are prepended.
<hr/>	
<b>Extension Range: 7000–7199 (2B data extensions), Pattern: 03</b>	<b>Extension Range: 3400–3499 (2B data extensions), Pattern: 03</b>
Route 01 Pool=3366, tandem PRI trunks FRL=1, Data	Route 01 Pool=4425, tandem PRI trunks FRL=1, Data
Route 02 Pool=3362, tandem PRI trunks FRL=3, Data	



**System A Local Dial Plan: 3100–3299;**  
**3400–3499**  
**Remote Access Code: 889**  
**Integrated VMI Calling Group for Routing**  
**to Centralized VMS/AA: 771**  
**Trunks: 3801-3880**

**System B Local Dial Plan: 6700–7199**  
**Remote Access Code: 122**  
**Centralized VMS/AA: 771**  
**Trunks: 8001-8080**

---

**Extension Range:** 122–122, Pattern: 04

Route 01  
Pool=3365, tandem PRI trunks  
FRL=5, Voice

Route 02  
Pool=3360, tandem PRI trunks  
FRL=6, Voice

---

**Extension Range:** 889–889, Pattern: 04

Route 01  
Pool=4423, tandem PRI trunks  
FRL=4, Voice

Route 02  
Pool=4420, tandem PRI trunks  
FRL=6, Voice

---

**Extension Range:** 7999–7999 (VMI conversion  
number for routing to centralized VMS/AA;  
assigned as single member of integrated VMI  
calling group 771) Pattern: 05

Route 01  
Pool=3360, tandem PRI trunks  
FRL=0, Voice  
All dialed digits are absorbed and the digits 771  
are prepended.

Route 02  
Pool=3365, tandem PRI trunks  
FRL=0, Voice  
All dialed digits are absorbed and the digits 771  
are prepended.

---

Table 2-2. Scenario 1: Facilities Planning, Calls Originating within the private network and Going to the PSTN		
Component	System A: New York, NY (Area Code: 212)	System B: Holmdel, NJ (Area Code: 732)
<b>DS1 Switch Type</b>	MERLIN LEGEND-PBX	MERLIN LEGEND-Ntwk
<b>ARS Access Code</b>	9	9
<b>Switch Identifiers Programmed on This System</b>	22 for a system that is within 200 miles (System B)	21 for a system that is within 200 miles (System A)
<b>Remote Access Code and COR for ARS Calls Routed Via This System</b>	Remote Access code: 889 All non-tie Outward Unrestricted Barrier Code Required (ignored for UDP extension and non-local ARS calls) Disallowed List 7 FRL=3*	Remote Access code: 122 All non-tie Outward Unrestricted Barrier Code Required (ignored for UDP extension and non-local ARS calls) Disallowed List 7 FRL=3*
<b>Centralized VMS/AA</b>	Integrated VMI calling group extension: 771 VMI conversion number (non-local dial plan member): 7999 UDP routing over route 01 or route 02, tandem PRI trunks FRL=0, voice All dialed digits are absorbed and the digits 771 are prepended.	Integrated VMI calling group extension: 771 Local dial plan members: extensions for ports used to connect VMS/AA. Message Waiting light updates for non-local subscribers are sent over the tandem PRI signalling D-channel

\* Local considerations may require a higher (more restrictive) FRL.

System A: New York, NY (Area Code: 212)

System B: Holmdel, NJ (Area Code: 732)

Dialed or Rec'd Digits	Rte	Pool Type	Abs	Prep	FRL	Dialed or Rec'd Digits	Rte	Pool Type	Abs	Prep	FRL
91732	1	Tandem	0	9	0	91212	1	Tandem	0	9	0
	2	Local PSTN	0	0	1		2	Local PSTN	0	0	1
91212	All	Local PSTN	4	0	0	91732	All	Local PSTN	4	0	0
91908	1	Tandem	0	9	1	91617	1	Tandem	0	9	2
	2	Local PSTN	0	0	2		2	Local PSTN	0	0	3
91617	All	Local PSTN	0	0	2	91908	All	Local PSTN	0	0	1

**Rte** = Sample route number (1= preferred routes; 2=secondary routes)

**Prep** = Prepended (prefixed) digits

**Abs** = Number of absorbed (deleted) digits

**FRL**= ARS Facility Restriction Level. For calls from the private network tandem trunks, it is compared to default COR for the type of tandem trunk. For local system calls (including remote access calls) it is compared to the extension or barrier code FRL of the caller.

## Routing for Outside Calls

This topic examines routing for hypothetical outside calls, to show how the system managers in Scenario 1 work together to maximize cost benefits from the private network. As you study the call route examples in [Table 2-4, page 2-27](#), review the general setup as described in [Table 2-2, page 2-24](#) and the ARS routing summary in [Table 2-3, page 2-25](#).

The first example call shows a user at the System A New York location dialing an ARS call beginning with the digits 91732, for a call in the same area code as the System B location in Holmdel, NJ. System A's ARS feature, invoked by the dialed 9, allows the call, because the Route 1 (and 2) FRL is 0, equal to the extension FRL. System A prepends the System B ARS access code, 9, and directs the call to Route 1, tandem PRI trunks connected to System B. The call is accepted by System B, because the FRL for the default COR assigned to all non-tie trunks takes the place of an extension FRL. Its value is 3.

If Route 1 is busy, System A's ARS directs the call to Route 2, which consists of pools of local PSTN trunks. However, the FRL of 1 for the second route is higher than the extension FRL of 0, so the call is denied. The user hears the fast busy tone and could turn on Selective Callback to wait for an available Route 1 tandem PRI trunk.

In this example and the others, the local ARS first allows or disallows the call based on the Allowed/Disallowed list and a comparison of the extension FRL and the FRL for the available route. If the extension FRL is equal to or higher than the route FRL, the call is permitted. If the call is routed to the other system, that system's ARS feature compares its route FRL to the default COR FRL assigned to all non-tie (tandem PRI) trunks before routing the call to the PSTN. Both systems use a default COR FRL of 3. The COR FRL must be equal to or higher than the route FRL in order for the call to go out. In your own system, you may need to assign a lower remote access COR FRL, depending upon whether you want to reserve local ARS routes.

The COR settings also include an option for barrier code requirement. This option is ignored for ARS-routed and intersystem extension calls that arrive on tandem trunks; no barrier code is required for these calls. However, if a remote access DID or PRI dial-plan routed call arrives at the local system from the PSTN, a barrier code *is* required; this requirement is important because the default COR settings does not outward restrict such remote access calls. In addition, a barrier code is required when a user dials a Remote Access code that is included in the non-local dial plan. The system managers apply FRL restrictions, outward restrictions, and Disallowed Lists to each barrier code.

Both systems assign Disallowed List 7 to the default, non-tie COR. This list prevents calls across the private network to 900 and 976 numbers, as well as to other numbers that organizations often want to prohibit. See ["Facility Restriction Levels and Remote Access" on page 5](#) for more information.

Table 2-4. Outside Calls: Scenario 1

Originating or Receiving System	Dialed Digits	Local Routing	Non-Local Routing
<b>System A:</b> Ext. FRL: 0	91732-555-1213	<p><b>Route 1:</b> ARS Area Code Table routes to tandem trunk pool, FRL 0, prepends 9 &lt;</p> <p><b>Route 2:</b> ARS Area Code Table routes to local PSTN pool, FRL 1, call prohibited for this user. Call denied. ●</p>	<p><b>Route 1, System B:</b> Remote access default FRL 3. ARS absorbs 1732, routes to PSTN pool.  </p>
<b>System B:</b> Ext. FRL: 3	91212-555-3316	<p><b>Route 1:</b> ARS Area Code Table routes to tandem trunk pool, FRL 0, prepends 9. &lt;</p> <p><b>Route 2:</b> ARS Area Code Table routes to local PSTN pool, FRL 1, call permitted for this user.  </p>	<p><b>Route 1, System A:</b> Remote access default FRL 3. ARS absorbs 1212, routes to PSTN pool.  </p>
<b>System A:</b> Ext. FRL: 1, Automatic Callback on	91908-555-6161	<p><b>Route 1:</b> ARS Area Code Table routes to tandem trunk pool, FRL 1, prepends 9. &lt;</p> <p><b>Route 2:</b> ARS Area Code Table would route to local PSTN pool, FRL 2, call prohibited for this user. Call denied. ●</p>	<p><b>System B:</b> All outside facilities are busy. Caller hears busy tone. Automatic Callback only works when local PSTN and private network facilities are busy, not PSTN facilities connected to another system. ●</p>
<b>System A:</b> Ext. FRL: 1, Automatic Callback on	91908-555-6161	<p>All local tandem facilities are busy. Call queues for Route 1. When Route 1 is available:</p> <p><b>Route 1:</b> ARS Area Code Table routes to tandem trunk pool, FRL 1, prepends 9. &lt;</p>	<p><b>System B:</b> Remote access default FRL 3. ARS absorbs no digits, routes to PSTN pool.  </p>

< = Call sent over tandem trunks      | = Call sent over PSTN      ● = Call ends

*Continued on next page*

Table 2-4. Outside Calls: Scenario 1, *Continued*

Originating or Receiving System	Dialed Digits	Local Routing	Non-Local Routing
<b>System A:</b> Receives outside dial-plan routed PRI data call at 64 kbps.	555-7002	<b>System A:</b> PRI dial-plan routing deletes 555, checks local dial plan, then finds number in non-local dial plan. Routes via non-local UDP Pattern 3 to PRI tandem trunk pool 3366 at 64 kbps, Data only <	<b>System B:</b> First part of 2B data call arrives at video system, Ext. 7002. When the second call is received, the data speed is 128 kbps. ●
<b>System A:</b> Receives outside dial-plan routed PRI-ANI voice call.	555-6871	<b>System A:</b> PRI dial-plan routing deletes 555, checks local dial plan, then finds number in non-local dial plan. Routes via non-local dial plan Pattern 2 to PRI tandem trunk pool 3364, Voice and Data <	<b>System B:</b> Arrives at Ext. 6871, MLX-10D®, displays with ANI information PRI-TRK 617-555-1212 ●
<b>System A:</b> Receives outside DID call.	555-6871	<b>System A:</b> DID receives 6871, checks local dial plan, then finds number in non-local dial plan. Routes via UDP Pattern 2 to PRI tandem trunk pool 3364, Voice and Data <	<b>System B:</b> Voice call arrives at Ext. 6871, displays as outside call on tandem trunk: PRI-TRK ●
<b>System A:</b> Receives outside dial-plan routed PRI voice call and is not available. Integrated VMI calling group provides coverage.	555-3105	<b>System A:</b> PRI dial-plan routing deletes 555, checks local dial plan. Call is sent to integrated VMI calling group 771 (with VMI conversion number 7999). The system finds the group member in the non-local dial plan. Routes via UDP Pattern 05 to PRI tandem trunk pool 3360. UDP routing absorbs 7999 and prepends 771 (System A's centralized integrated VMI calling group extension). <	<b>System B:</b> Calls ring into centralized VMS/AA and calling information indicates an outside call. When the caller leaves a message, the Message Waiting light update is sent over the private network to extension 3105 on System A. ●

< = Call sent over tandem trunks      | = Call sent over PSTN      ● = Call ends

## Intersystem Calling

This topic illustrates how different types of calls are made and received in Scenario 1, using the extension numbers and extension equipment types shown in [Figure 2-1](#). [Table 2-5, page 2-30](#) enumerates some sample calls, showing how they are displayed at different recipients' extensions within the private network. As you review this information, notice the following features:

- Because the private tandem trunks are PRI, the systems display calling name, calling extension number, or both for arriving non-local dial plan calls. The display varies according to the display preference programming for the MLX extension. Contrast this display with those in Scenario 2, [Table 2-12, page 2-55](#).
- Wherever a person is in the private network, he or she dials another private network user the same way regardless of location.
- Manually transferred calls within the private network display in the same way as direct calls between extensions. The originating extension information is shown, with no indication that the call is a transfer.
- Both outside callers and callers within the private network hear Music On Hold when their calls are transferred to a non-local extension.
- PassageWay client screen displays vary depending upon the PassageWay implementation. Therefore, the table shows the information that the system *can* send to the CTI-linked application; if an MLX-20L<sup>®</sup>, for example, were a display telephone receiving the call, the display would appear as shown in the table.
- For centralized VMS/AA, call information signals are sent with the call from the remote system over the PRI tandem trunk so that the centralized VMS/AA can distinguish between inside and outside calls. Message Waiting light updates are sent over the PRI signalling D-channel from the central site to the remote system so there is no need to compete with voice calls for updates.

**Table 2-5. Intersystem Calling: Scenario 1**

Type of Call	Caller	Caller Dials	Recipient	Recipient Sees...
Non-local extension	System A: Ext. 3212	6777	System B Ext. 6777, MLX-10D Display: Number	PRI-TRK 3212
Non-local extension	System B: Ext. 6988	3212	System A Ext. 3212, MLX-20L Display: Both	WONG S 6988
Non-local extension	System A: Ext. 3105	6819	System B Ext. 7019, Analog multiline display	PRI-TRK
Non-local remote access	System A: Extension with FRL 5	122	Call routed via Pattern 4, Route 1, FRL 5. System B accepts call. Remote Access feature requires barrier code	Not Applicable
Manual transfer of local inside call from 6871 to non-local extension 3212	System B: Ext. 6988	At extension 6871 Transfer 3212	System A Ext. 3212, MLX-20L Display: Both	RICK S 6871

*Continued on next page*



**Table 2-5. Intersystem Calling: Scenario 1, Continued**

Type of Call	Caller	Caller Dials	Recipient	Recipient Sees...
Transfer of outside GS/LS call to non-local extension	Outside to System A: Ext. 3105	<b>Transfer</b> 6871	System B Ext. 6871, MLX-10D Display: Number	PRI-TRK 3105
Transfer of outside PRI-ANI call to non-local extension. Initial System A recipient sees ANI information, for example, PRI-TRK 408-555-1212	Outside to System A: Ext. 3212	<b>Transfer</b> 6988	System B Ext. 6988, PassageWay client, no screen pop from original caller received. Phone at extension displays transfer originator information. Display: Both	ANGEL 3212
Caller ID PSTN call on loop-start line	Outside to System B, which routes call to a local extension that has delayed Remote Call Forwarding to a System A extension turned on.	555-6000 (System B Listed Directory Number)	System B extension user has turned on Remote Call Forwarding to System A Ext. 3212, MLX-20L by dialing: *33 + 801 (tandem PRI trunk no.) + 3212 + #	LDN 732-555-6643
Transfer of outside call to local extension on System A. Extension is busy or unavailable. Centralized VMS/AA provides coverage.	Outside to System A: Ext. 3233	<b>Transfer</b> 3105	System B Ext. 771, centralized VMS/AA. Call information signals received from System A indicate an outside call.	Not Applicable
Outside call to calling group on System A. All group members are busy and overflow threshold is reached. Centralized VMS/AA provides coverage.	Outside to System A: overflows to local integrated VMI calling group 771.	555-6012 (programmed to ring into calling group).	System B Ext. 771, centralized VMS/AA. Call information signals received from System A indicate an outside call.	Not Applicable

## Scenario 2: Two Systems, Tandem Tie Facilities

---

Scenario 2 describes a medium-sized, mail-order company that has two locations, one in Chicago and one in California. This scenario includes more system details and fuller descriptions of business needs than do the others in this chapter. The various departments and staff use two MERLIN LEGEND Communications Systems connected by tandem T1-emulated tie trunks that provide fractional point-to-point service; some T1 channels are programmed for voice and others are programmed for data only. In this company, there is one system manager, who also acts as Manager of Information Systems for the company's computer systems. It is designed to put networking in the context of a complete system. The company conducts catalog sales with supervised groups of order-takers and customer service representatives. It also sells to large corporate customers through a field sales force.



### NOTE:

It is recommended that PRI lines, rather than tie lines, be used between MERLIN LEGEND Communications systems in a private network that utilizes the Centralized Voice Mail feature. Refer to [Table 1-1, page 1-11](#) for advantages of PRI lines.

With a view to examining networked systems in a larger context of overall business needs and system features, this scenario discusses the following topics:

- **Company Needs.** General, group, and individual requirements for communications system and application functionality
- **General System Description.** A summary of the equipment, features, and applications that meet company needs overall and specifically help certain work groups and individuals
- **Network Planning and Maintenance.** A description of how the private network is set up and how calls are handled to fulfill the company's requirements

## Company Needs

Company needs and the solutions provided by the system fall into the following categories:

- **General.** Broad concerns that affect the company as a whole and require basic decisions about the lines/trunks used in the system
- **Work Groups.** Specific communications needs of groups who work together
- **Individuals.** Needs of individuals, such as the system manager and off-site employees

[Figure 2-2](#) illustrates the locations and staffing.

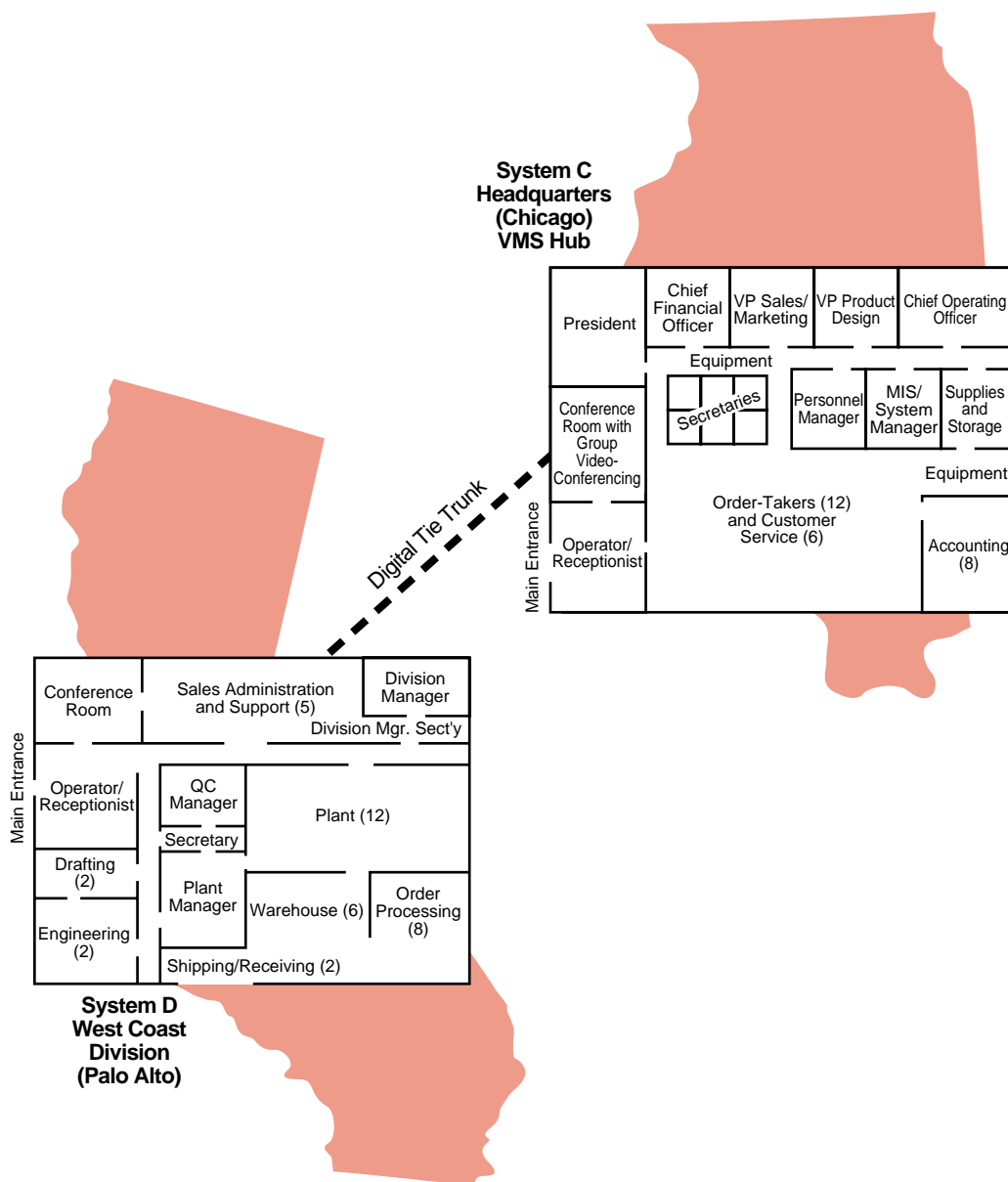

Figure 2-2. Scenario 2: Company Floor Plans

## General Needs

The company has several broad areas of concern:

- Connectivity
- Cost-effective calling
- Customer service
- Toll fraud and calling restrictions

In addition, the company would like to provide these features to all or many employees:

- Easy dialing of non-local extensions and frequently called numbers
- Covering of calls
- Answering of calls after hours
- Share voice/fax messages from customers with co-workers
- Broadcast voice messages to all employees

**Connectivity.** The two sites need to communicate easily by voice and also must transmit data rapidly back and forth between headquarters and West coast operations.

Many staff members in both locations require connectivity to the company's customer, inventory, and order processing databases. The company uses two local area networks (LANs) that share data communications equipment (DCE) connected to LAN servers. The LANs are internetworked. Volume is high, and communications must be speedy in order to serve both direct marketing and corporate customers.

Customers place orders to high-speed Group IV (G4) fax machines and also use slower analog fax equipment. In addition, some customers transmit orders electronically over the Internet, and off-site employees in particular find Internet electronic mail convenient. They also must access their company voice mailboxes from the field.

Executives and professional staffers use the Internet to communicate with customers and associates outside the company, review developments in their industry, and keep up with professional organizations in their fields.

In addition, executives use videoconferencing to meet without the need for travel. Furthermore, videoconferencing and data-sharing are also essential to ensure that product design and factory operations mesh smoothly and that manufacturing problems are resolved rapidly.

**Cost-Effective Calling.** The company uses incoming and outgoing 800 and WATS services for customer interaction. In addition, customers need to call in directly when they require help, without going through an operator. They often use an automated response system to check their order status or place a small order.

To simplify cost accounting and make outcalling more economical, field representatives access the West coast system remotely, then use the system to dial out to customers, make intersystem calls to headquarters in Chicago, and make ARS calls to the Midwest.

Employees at each location use ARS to dial numbers in the local calling area of the other system, and the system manager has programmed ARS to decrease toll costs for these calls. Later in this scenario, [“Network Planning” on page 44](#) provides additional details.

**Customer Service.** The company wants customers to receive prompt, courteous attention when they must speak to an order-taker or customer service representative. The staff works closely together to ensure that agents understand how to use the communications systems effectively to provide the best possible service. The staff supervising the customer service representatives observes the calls to ensure that every customer receives prompt, courteous attention. Managers must ensure that staffing levels and communications facilities respond to customer needs during both peak and off-peak call-in times.

**Toll Fraud and Calling Restrictions.** The company must keep tight control of telecommunications costs and prevent toll fraud by hackers attempting to access their system remotely and then dial out from it. When a new product is released, the company brings in temporary order-taking agents, and this also presents a toll-fraud risk.

### Work Group Needs

Several groups of people work together and interact with customers and co-workers in similar ways. Some of them also have individual needs.

[Table 2-6](#) outlines the needs of work groups.

**Table 2-6. Work Group Needs**

<b>Work Group</b>	<b>Needs</b>
President and vice-presidents, W. Coast Division Mgr., Plant Mgr., Personnel Mgr.	Ability to meet frequently, face to face, without incurring travel costs
Executive Secretaries	Ability to receive bosses' calls directly, without those calls going through an operator/receptionist Call-covering by other secretary or centralized VMS/AA
Vice-President of Product Design Product engineers Quality Assurance Engineers Plant Manager Drafters	Ability to exchange and work together individually on documents and computer-generated images Ability to meet as a group without incurring travel costs
Vice-President of Marketing and Sales	Ability to access either system remotely for calling customers and associates. Ability to assess performance of order-takers and customer service reps as well as field sales personnel.

*Continued on next page*

Table 2-6. Work Group Needs, *Continued*

Work Group	Needs
Order-Takers and Customer Service Personnel	<p>Ability for small-order customers to access an automatic ordering system in which they use their touch-tone phones to enter account numbers, product codes, and so on, without having to wait for an agent. They have the option of speaking to an agent.</p> <p>Ability for calls from customers who buy in large quantities to be directed to the groups of agents, bypassing the operator, so that the most-idle agent can answer a call. If no agents are available, the caller should hear an initial announcement stating that an agent will soon take the call and offering the option to leave a voice mail message instead of waiting. For callers who must wait longer, a second announcement is needed to urge callers to stay on the line. While a caller is on hold, he or she should hear music.</p> <p>Ability to use a LAN-based software application, in conjunction with PRI-ANI services from a telecommunications provider, to rapidly pop up database information about a customer, based on the caller's telephone number.</p> <p>Hands-free operation of their telephones so they can enter order information, review customer history, or check on orders in progress while talking to a customer</p> <p>Stringent calling restrictions for all agents except those allowed to use WATS services.</p> <p>Ability for callers to fax or email orders.</p>

*Continued on next page*

Table 2-6. Work Group Needs, *Continued*

Work Group	Needs
Order-Takers' and Customer Service Supervisor	Ability to observe and control the order agents' calls (for example, to know who is available) and immediately see whether too many callers are waiting. When a caller has waited a certain length of time or a caller has asked to leave a message, the call should go to a voice messaging system. When a caller hangs up without speaking to a company representative, the supervisor must be able to call the customer back promptly.
Sales Support Staff	Barrier code (password) access for remote access callers, to help avoid toll fraud by hackers
Field Sales Representatives	Ability for field representatives to have calls forwarded from the West coast office to their off-site telephones
Factory and Warehouse Personnel	Ability to be summoned by loudspeaker when necessary Ability to hear an extra alert when a call arrives in some noisier areas Calling restrictions

### Individual Needs

[Table 2-7](#) describes the individual needs of certain staff members.

Table 2-7. Individual Needs

Staff Members	Needs
Executive Managers	Ability to make unrestricted calls from any extension Screening and coverage of all calls, by secretary during normal hours and by centralized VMS/AA after hours Ability to work or confer without being disturbed, even by secretary
Executive Secretaries	Ability to receive bosses' calls directly, without those calls going through an operator/receptionist Call-covering by other secretary or centralized VMS/AA when unavailable
System Manager/MIS Manager	Ability to manage two systems using computers Ability to manage one system remotely Ability to generate reports about phone usage, call traffic, and facilities usage

*Continued on next page*



Table 2-7. Individual Needs, *Continued*

Staff Members	Needs
Operator/ Receptionist (Headquarters)	Ability to page certain groups or all staff members  Answering of all calls, except those that go directly to agents or executive secretaries, by an automated operator who directs calls according to the touch-tones entered by callers; callers can choose to talk to the operator by pressing □.

## General System Description

The system includes equipment, system features, and applications to satisfy needs in three categories:

- Company-wide
- Work groups
- Individuals

### Company-Wide System Equipment and Features

The company uses the following general equipment and applications to provide basic functionality for the business:

- **PSTN Lines/Trunks.** Both systems use Digital Signal 1 (DS1) facilities, connected to the system by 100D modules, providing more features, speed, and toll-fraud security than ground-start or loop-start lines/trunks. The West coast T1 facility consists of 24 channels. A channel functions as a line/trunk and is programmed for voice (analog service) or data (T1 Switched 56 digital service). T1 channels are also used for personal lines, for analog data transfer with outside parties by modem or analog fax machine. T1 Switched 56 digital service supports videoconferencing as well as data exchange through ISDN terminal adapters.

At headquarters in Chicago, order-takers and customer service staffers use outside PRI facilities. This provides call routing by dial plan for DID-like functionality and allows the phone agents to take advantage of ANI services that the company subscribes to from network service providers. The ANI service provides incoming caller information for customer calls arriving on the customer 800 lines.

At headquarters, the company's CTI link allows use of PassageWay Telephony Services applications over the company's LANs, which run Novell® NetWare® software. MERLIN LEGEND Reporter collects call information from the Station Message Detail Recording (SMDR) jack at the headquarters location.

In addition, each location has one 800 LS/ID line/trunk module. Loudspeaker paging and Music on Hold connect to this module; an emergency loop-start line is also connected to each system for use in the event of a power failure. It also provides needed Touch-Tone Receivers.

- **Tandem Trunks.** The systems are linked by 24 T1-emulated tie channels programmed for voice and data, and a T1 to the PSTN requiring a 100D module at both sites for private networking, for a total of three 100D modules at headquarters and two at the West coast office.

**NOTE:**

Later in this scenario, [“Network Planning” on page 44](#) provides additional information about how private network facilities and calls are set up.

- **Extension Modules.** Both systems use 008 MLX extension modules to connect MLX telephones and digital equipment. One MLX port is used to connect the headquarters’ CTI link hardware, which also links to a LAN server running Novell NetWare software. Each control unit includes 016 tip/ring extension modules for connecting modems, fax/modems, analog fax machines, and automated answering applications.
- **Common Equipment.** LANs equipped with shared modems and fax modems serve the data communications needs of many employees at both sites. They also share common-area fax machines, both high-speed digital Group IV and analog devices.
- **General Extension Equipment.** Each extension includes an MLX telephone. Most extensions include a PC or terminal connected to a LAN, sharing digital communications equipment or modems. Some extensions also include ISDN terminal adapters for high-speed data communications.
- **Intuity AUDIX®.** The headquarters system has an Intuity AUDIX to supply centralized voice messaging service for both sites. The application connects to a 016 tip/ring extension module.
- **Voice Messaging Service for Both Sites.** At the West Coast site, an integrated VMI calling group with a single non-local member is created with the same main extension number as that of the integrated VMI calling group for the centralized VMS/AA at the Headquarters site. Extensions at the West Coast site with mailboxes on the centralized VMS/AA are assigned to a coverage group. The integrated VMI calling group at the West Coast site is programmed as the Group Coverage receiver for the coverage group and is also programmed to provide overflow coverage for calling groups at the West Coast site.

**NOTE:**

Since the two systems are connected by tie lines, all calls sent from the West Coast site to headquarters for centralized VMS/AA coverage are treated as outside calls and Message Waiting light updates may be delayed. For better service, use PRI tandem trunks instead of tandem tie trunks.

Other system equipment includes Uninterruptible Power Supplies (UPSs) to supply backup power in the event of a commercial power failure.

People in both locations use these features:

- **Covering Calls.** In workgroups and in the executive suite, calls are covered using **SSA** buttons, call coverage features (Cover buttons and coverage to the centralized VMS/AA), Call Forwarding, and Group Pickup.
- **Security.** Authorization Codes allow executives to call from any extension using their own privileges. ARS restrictions limit toll-calling privileges for many extensions. The system manager applies most restrictions at the extension level. Temporary calling group agents do not need to make intersystem calls and are prevented from doing so or from making toll calls. For Release 3.1 or later systems, voice mail ports are factory set with an FRL of 0, prohibiting outcalling.



**SECURITY ALERT:**

*For more information about security, consult "Security of Your System: Preventing Toll Fraud," in Appendix A, "Customer Support Information" and Chapter 4, "Security."*

- **Speed Dialing.** Personal and System Speed dial codes and directories help people quickly reach frequently called numbers. Some staff members also use Auto Dial buttons. PassageWay Telephony Services clients use power-dialing applications for rapid outcalling to customers. On each system, the System Directory includes entries for non-local extensions.



**SECURITY ALERT:**

*Never program passwords and/or authorization codes as Speed Dial codes.*

Both features and equipment fill paging needs. A loudspeaker paging system connected to the control unit in the West coast office allows the receptionist to page people working in noisy areas such as the factory. The system's Group Paging feature serves the same purpose for people in offices.

## Work Groups

The following work groups use specialized equipment, features, and applications that serve their needs:

- **Executive Managers.** Each location includes a conference room with a group videoconferencing system that allows face-to-face meetings. The systems use one MLX port each (programmed for 2B data). Video extensions use both tandem T1 tie trunks programmed for data to communicate with the extensions on the other system and PSTN digital facilities for meetings with key corporate customers.

- **Agent Groups.** When calls are routed by dial plan from outside PRI facilities with ANI, agents use a LAN-based PassageWay Telephony Services application to access customer information as calls arrive. Calling party information is used as a key field in the company's customer database, and allows agents' PassageWay Telephony Services worktop software applications to bring up customer history files. Customer service representatives use a CTI link power-dialing LAN application to reach large numbers of customers rapidly.

Two delay announcement devices are attached to play messages for customers calling both groups. The primary delay announcement device plays an announcement for callers; a secondary delay announcement reassures those callers who have waited for 30 seconds or more after hearing the first announcement. Callers also hear Music On Hold while they wait. During a delayed announcement, callers have the option of dialing # in order to leave a message for an agent at the centralized VMS/AA, rather than waiting in the calling group queue.

Supervisors have Direct-Line Consoles (DLCs) and Direct Station Selectors (DSSs) with a button for each agent extension on the local system, and with the Extension Status feature to monitor the status of agents' extensions. The Group Calling Overflow Threshold Time setting signals when too many callers are waiting in the queue. Supervisors use the system's MERLIN LEGEND Reporter application to respond when a customer calls service or order-taking groups and then hangs up before an agent answers. MERLIN LEGEND Reporter signals a hang-up, recording the phone number of the caller.

For Release 6.1 or later systems only, supervisors have Service Observing buttons on their stations so that they may observe calls in-progress at customer service representative's extensions. Supervisors cannot observe calls across the private network.

For faxed-in orders, fax machines are in a calling group so that they are accessed through one phone number; orders are received by the next available fax machine in the group.

A programmed button on the supervisor's console signals when too many callers are waiting; its LED signals three levels of severity (Release 5.0 and later systems only) by flashing, winking, or lighting steadily.

All agents' phones have headsets attached for hands-free operation.

Two agents in each group use ISDN terminal adapters to respond to orders and customer service requests through Internet electronic mail.

- **Engineering Group.** Design and quality engineers, along with drafters and the Vice-President of Product Design, share a desktop videoconferencing workstation in the West coast office. There is also a desktop video system at headquarters. They use this desktop videoconferencing application for data-sharing, video meetings, and cooperative work on documents. Each desktop video system uses one MLX port and two T1 channels (2B data) programmed for data operation; communication is at 112 kilobits per

second. No additional data communications equipment (DCE) is required. The engineers sometimes use the group videoconferencing system described earlier in this section, which requires two MLX ports.

- **Factory and Warehouse Personnel.** People in the warehouse and factory hear loudspeakers from the paging system. When a call comes into these areas, extra bells alert personnel on the floor.
- **Sales Group.** Remote Access passwords (barrier codes) help ensure that field representatives, not hackers, are able to first access the systems and then call out; passwords are associated with FRL restrictions, and the system manager changes the passwords often.

Although most reps do not have on-site offices, they do have voice mailboxes in the centralized VMS, generally using phantom extensions. Regional reps in the West Coast and Headquarters offices have system extensions for the convenience of customers, but frequently use the Remote Call Forwarding feature to send their calls to their off-site offices.

## Individuals

The following equipment, features, and applications meet the needs of individuals at the company:

- **Executives.** Executives use the Do Not Disturb feature to prevent calls from ringing while in meetings and conferences. They also use the Authorization Codes feature for calling from any extension using their own calling privileges. Executives use MLX-16DP<sup>®</sup> telephones. (See below for a description of how executive calls are covered.)
- **Executive Secretaries.** The system's Shared System Access (**SSA**) buttons allow secretaries to answer their bosses' calls. The system's Notify feature allows assistants to visually alert executives when a caller is waiting. When the callers request it, the secretaries can transfer them to voice mail using the Direct Voice Mail feature.



### NOTE:

The Direct Voice Mail feature works only when the person calling and the person being called are located on the same MERLIN LEGEND system.

When a secretary is unavailable, she uses either the centralized voice messaging system (after hours) or another secretary as backup. Each secretary has **SSA** buttons for each executive; calls for a secretary's own boss ring immediately; calls for another executive ring after a delay. When calls on **SSA** buttons cover to centralized VMS/AA, they go to the managers' mailboxes. Secretaries use MLX-20L telephones so that they can easily dial for their bosses.

- **Operator/Receptionist.** Each operators/receptionist at headquarters uses an MLX-20L telephone programmed as a Queued Call Console (QCC). Callers to either location who wish to speak to an operator/receptionist, rather than to Intuity AUDIX, can press  $\square$  and are redirected to the QCC at headquarters.
- **System Manager.** The system manager manages both systems. The system manager accesses the West Coast system by dialing its Remote Access code, which is included in the non-local dial plan. For security reasons, she changes her barrier code two or three times a week. The system manager has an MLX-20L telephone and uses System Programming and Maintenance (SPM) for the on-site and remote systems. The system manager has a dedicated modem to ensure immediate access to the remote system. Her PC is directly connected to the on-site system.

To help with her own assessments of facilities usage, the system manager uses each system's MERLIN LEGEND Reporter application. Working closely with customer service and sales supervisors, she analyzes the effectiveness of the system's facilities during peak and off-peak incoming calling periods. She ensures that customer service and order-taking agents understand how to get the most from the lines/trunks that the company has. MERLIN LEGEND Reporter helps managers balance staffing, staff training, and facilities needs to serve customers effectively and efficiently.

## Network Planning

In this sample scenario, the two systems are linked in a private network using T1 tandem tie trunks that support fractional point-to-point use. Some channels are dedicated to voice traffic, emulating analog tie trunks, and some are dedicated to T1 Switched 56 data.

[Figure 2-3](#) presents some PSTN facilities, types of extensions, and tandem tie trunks for this company. A few extensions are shown to demonstrate how calls are handled and how they display for call recipients at different types of extension equipment. Similarly, sample PSTN facilities are shown in order to illustrate routing when non-local callers use them or when outside calls are transferred or routed across the private network.

### Non-Local Dial Plans and Facilities Planning

This section shows how non-local dial plans, calling groups, switch identifiers, UDP routing, ARS routing, and remote access are set up for each system. Not all details are provided for all facilities and extensions.

[Table 2-8, page 2-48](#) shows the applicable extension ranges, patterns, and routes for pooled facilities when people in one system call people at non-local dial plan extensions. Pools of T1 Switched 56 channels are reserved for video and data calls, and intersystem 2B data calls are supported at 112 kbps. At headquarters, executives conduct videoconferences over PSTN facilities at 128 kbps.

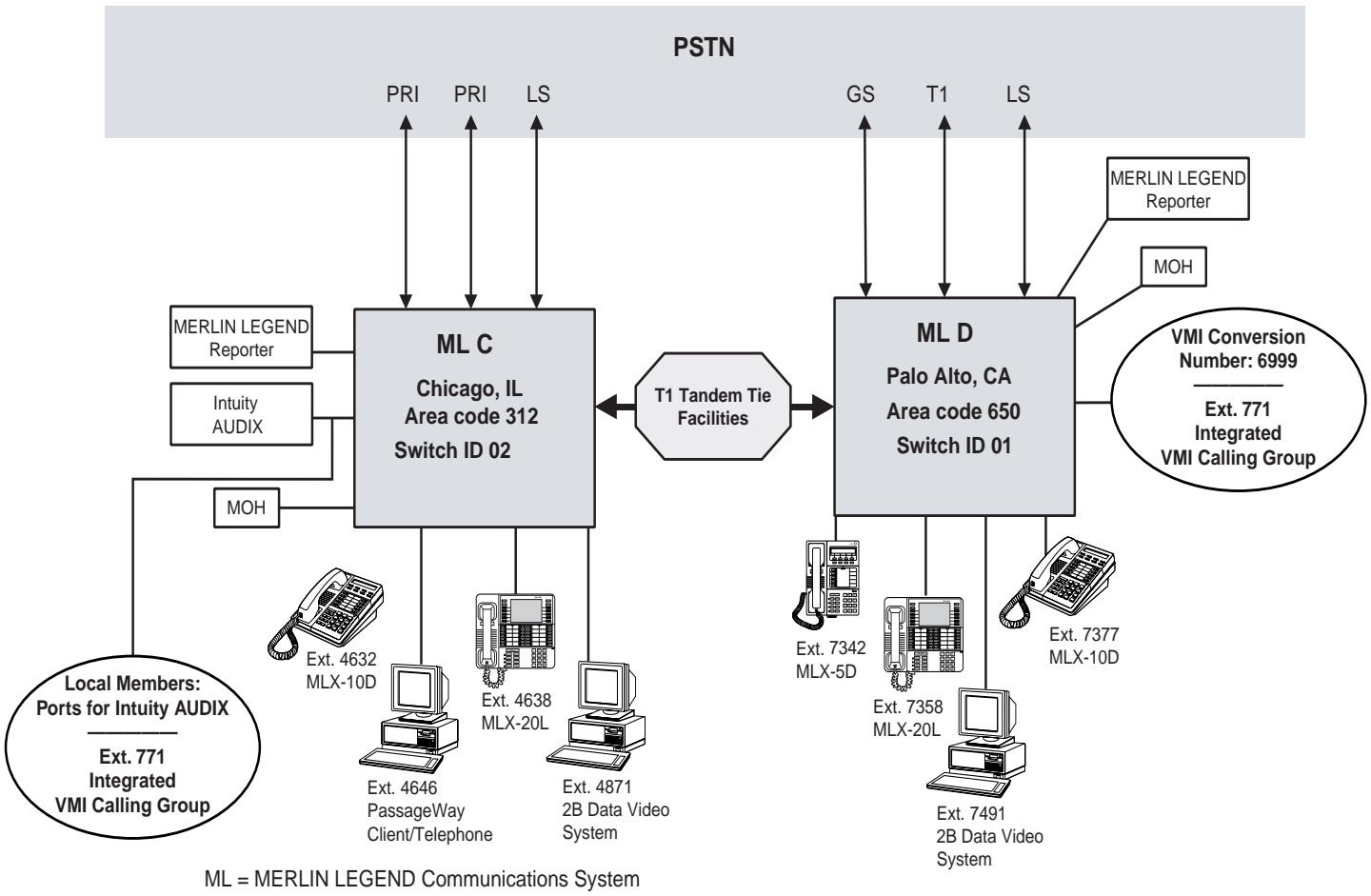

Figure 2-3. Scenario 2: Overview

[Table 2–9, page 2-49](#) shows how the system manager sets up the systems so that users on each system can access the PSTN facilities connected to the other system. Routing details are summarized in [Table 2–10, page 2-50](#). As you review these tables, keep the following points in mind:

- SMDR is set up to record incoming and outgoing calls with Talk Time enabled, and MERLIN LEGEND Reporter supplies more refined and detailed information about the calling group calls on System C, where order-takers and customer service are located. The system manager must take time zone differences into account. For example, if an ARS call is routed over private trunks from System C to System D, System C's SMDR report might show the outgoing call, at 2:00 p.m. local time, on a tandem tie trunk. The same call is reported on System D's SMDR report at about 12:00 noon local time.
- In this scenario, UDP routes are set for either voice or data but never both. Tandem T1 tie trunks do not allocate voice and high-speed data service dynamically. Because video and 2B data traffic is limited to a few extensions on each system, most T1 tandem tie channels are used for voice communications and set for Tie-PBX operation; data tie channels are programmed for data.
- Security considerations are paramount because of the seasonal workers employed both at the headquarters office and the West coast office during busy sales and shipping periods (although West coast temporary shipping personnel have less access to telephones). Many extension FRLs are set to 0 and 1, the most restrictive values. As an extra safeguard, the remote access default COR FRL is set at 3 on both systems. This allows certain local ARS routes to be reserved for special purposes and prevents international calling via a non-local system. As in Scenario 1, barrier codes are required for non-network and intersystem remote access calls made by dialing a non-local Remote Access code.
- The system manager and one technician use the Remote Access codes programmed into the non-local dial plan to program the other system on the private network. Therefore the UDP route is set to 6, and only a few users can access it. The manager and technician use all 11 characters of their barrier codes and change them two or three times a week.



**2 Call-Handling Scenarios**

*Network Configuration Scenarios*

*Page 2-47*

- Customer service reps use OUTWATS lines to call many customers in the U.S., and the company has a discounted pricing plan for these calls. For this reason, ARS routing does not direct all Chicago-to-California calls across the private network.
- The system manager may program other area codes for calling via ARS across the private network. Only a sample is shown.
- Because the systems are more than 200 miles apart, FRLs are very stringent for secondary routes that use local PSTN facilities rather than taking advantage of the primary routes that send calls on private network trunks to PSTN facilities connected to the other system.

Table 2-8. UDP Extension Ranges: Scenario 2

<p><b>System C Local Dial Plan: 4630-4699; 4850-4899; Remote Access Code: 889</b>  <b>Centralized VMS: 7771; Trunks 8001-8080</b></p>	<p><b>System D Local Dial Plan: 7340-7379; 7460-7499; Remote Access Code: 326</b>  <b>Integrated VMI Calling Group for Routing to Centralized VMS: 7771; Trunks 8801-8880</b></p>
<p><b>Extension Range: 7340-7379</b>                  Pattern: 01                   Route 01,                  Pool=5810, T1-emulated tandem tie                  FRL=3, Voice</p>	<p><b>Extension Range: 4630-4699</b>                  Pattern: 01                   Route 01                  Pool=6130, T1-emulated tandem tie                  FRL=3, Voice</p>
<p>Route 02                  Pool=5950, PSTN facilities                  FRL=6, Voice</p>	<p>Route 02                  Pool=6250, PSTN facilities                  FRL=4, Voice</p>
<p><b>Extension Range: 7460-7499</b>                  Pattern: 02</p>	<p><b>Extension Range: 4850-4899</b>                  Pattern: 02</p>
<p>Route 01                  Pool=5816, T1-emulated tandem tie                  FRL=3, Data</p>	<p>Route 01                  Pool=6136, T1-emulated tandem tie                  FRL=3, Data</p>
<p><b>Extension Range: 326-326 (Remote Access)</b>                  Pattern: 03</p>	<p><b>Extension Range: 889-889 (Remote Access)</b>                  Pattern: 03</p>
<p>Route 01                  Pool=5810, T1-emulated tandem tie                  FRL=6, Voice</p>	<p>Route 01                  Pool=6130, T1-emulated tandem tie                  FRL=6, Voice</p>
	<p><b>Extension Range: 6999-6999 (VMI conversion number for routing to centralized VMS/AA; assigned as single member of integrated VMI calling group 7771)</b>                   Pattern: 04                   Route 01                  Pool=6130, T1-emulated tandem tie                  FRL=0, Voice                   All dialed digits are absorbed and the digits 7771 are prepended</p>

Table 2-9. Scenario 2: Facilities Planning, Calls Originating within the private network and Going to the PSTN

Component	System C: Chicago, IL (Area Code: 312)	System D: Palo Alto, CA (Area Code: 650)
<b>DS1 Switch Type</b>	MERLIN LEGEND-PBX	MERLIN LEGEND-Ntwk
<b>ARS Access Code</b>	9	9
<b>Switch Identifiers Programmed on This System</b>	01 for a system more than 200 miles away (System D)	02 for a system more than 200 miles away (System C)
<b>Remote Access Code and COR for UDP and ARS Calls via This System</b>	Remote Access Code: 889 All tie (T1-emulated voice and data) Outward Unrestricted Barrier Code Required (ignored for UDP extension and non-local ARS calls) Disallowed List 7 FRL=3	Remote Access Code:326 All tie (T1- emulated voice and data) Outward Unrestricted Barrier Code Required (ignored for UDP extension and non-local ARS calls) Disallowed List 7 FRL=3
<b>Centralized VMS/AA</b>	Integrated VMI calling group extension: 7771 Local dial plan members: Extensions for system ports used to connect VMS/AA Message waiting light updates for non-local subscribers compete for tandem tie trunks and touch-tone receivers with other voice and data traffic.	Integrated VMI calling group extension: 7771 VMI conversion number (non-local dial plan member): 6999 UDP routing over route 1, T1-emulated voice tie, FRL=0, voice, all dialed digits are absorbed and the digits 7771 are prepended.

System C: Chicago, IL (Area Code: 312)

System D: Palo Alto, CA (Area Code: 650)

Dialed or Rec'd Digits	Rte	Pool Type	Abs	Prep	FRL	Dialed or Rec'd Digits	Rte	Pool Type	Abs	Prep	FRL
91650	1	Tandem	0	9	2	91312	1	Tandem	0	9	1
	2	Local PSTN	0	0	5		2	Local PSTN	0	0	4
91408	1	Tandem	0	9	3	91773	1	Tandem	0	9	2
	2	Local PSTN	0	0	5		2	Local PSTN	0	0	4
91415	1	Tandem	0	9	2	91650	All	Local PSTN	4	0	1
	2	Local PSTN	0	0	4	91408	All	Local PSTN	0	0	2
91312	All	Local PSTN	4	0	1	91415	All	Local PSTN	0	0	2
91773	All	Local PSTN	0	0	2						

**Rte** = Sample route number (1= preferred routes; 2=secondary routes)  
**Abs** = Number of absorbed (deleted) digits

**Prep** = Prepended (prefixed) digits  
**FRL**= ARS Facility Restriction Level. For calls from the private network tandem trunks, it is compared to default COR for the type of tandem trunk. For local system calls (including remote access calls) it is compared to the extension or barrier code FRL of the caller.

## Routing for Outside Calls

This topic examines routing for hypothetical outside calls, to show how the system manager in Scenario 2 maximizes cost benefits from the private network. As you study the example call routes in [Table 2-11, page 2-52](#), review the general setup as described in [Table 2-9, page 2-49](#) and [Table 2-10, page 2-50](#).

Note the following facts about routing for outside calls in this scenario:

- A PRI dial-plan routed call can be routed across the private network to a telephone extension. However, even if ANI information is available, it cannot be displayed at the recipient's extension. An example is not included, but the display would show information about the tandem tie trunk only, for example: TIE-TRK.
- Remote access callers to one system can dial non-local extension numbers.
- From System C at headquarters, 2B data calls made over the outside PRI facility can achieve a higher data rate, 128 kbps, than intersystem video calls, which are routed over T1 data tie channels at 112 kbps.
- PassageWay Telephony Services clients receive screen pop on incoming customer calls that they receive on outside PRI facilities, but they do not receive screen pop on those rare occasions when calls are transferred from headquarters in Chicago.

Table 2-11. Outside Calls: Scenario 2

Originating or Receiving System	Dialed Digits	Local Routing	Non-Local Routing
<b>System C:</b> Ext. FRL: 2	91650-555-1218	<p><b>Route 1:</b> ARS Area Code Table routes to tandem trunk pool, FRL 2, prepends 9 &lt;</p> <p><b>Route 2:</b> If all lines in Route 1 are busy, ARS Area Code Table routes to local PSTN pool, FRL 5, call prohibited for this user. Call denied ●</p>	<p><b>Route 1, System D:</b> Remote access FRL 3. ARS absorbs 1650, routes to PSTN pool.  </p>
<b>System C:</b> Ext. FRL: 0	91650-555-1218	<p><b>Route 1:</b> ARS Area Code Table routes to tandem trunk pool, FRL 2, call prohibited for this user. Call denied ●</p>	
<b>System D:</b> System D remote access user dials System D on GS line	1650-555-7351, plus barrier code with FRL of 3; upon hearing dial tone, dials 4632	System D searches local dial plan, finds number in non-local dial plan and routes to tandem trunk pool, UDP Pattern 1, Route 1, FRL 3 <	<b>System C:</b> Call received at Ext. 4632. ●
<b>System D:</b> Ext. FRL: 4	91312-555-5163	<p><b>Route 1:</b> ARS Area Code Table routes to tandem trunk pool, FRL 1, prepends 9 &lt;</p> <p><b>Route 2:</b> If all lines in Route 1 are busy, ARS Area Code Table routes to local PSTN pool, FRL 4.  </p>	<p><b>Route 1, System C:</b> Remote access FRL 3. ARS absorbs 1312, routes to PSTN pool.  </p>
<b>System C:</b> Receives outside dial-plan routed PRI 2B data calls at combined speed of 128 kbps.	555-7491	System C PRI dial-plan routing deletes 555, checks local dial plan, then finds number in non-local dial plan. Routes via non-local dial plan Pattern 2 to tandem data pool, Data only < Call denied because of bearer capabilities	
< = Call sent over tandem trunks        = Call sent over PSTN      ● = Call ends			

Continued on next page

Table 2–11. Outside Calls: Scenario 2, Continued

Originating or Receiving System	Dialed Digits	Local Routing	Non-Local Routing
<b>System C:</b> Ext. FRL: 1	91408-555-6161	<b>Route 1:</b> ARS Area Code Table routes to tandem trunk pool, FRL 3, call prohibited for this user. Call denied ●	
<b>System C:</b> Ext. FRL: 3	91415-555-4446	<b>Route 1:</b> ARS Area Code Table routes to tandem trunk pool, FRL 2, prepends 9. < <b>Route 2:</b> If all lines in Route 1 are busy, ARS Area Code Table routes to local PSTN pool, FRL 4, call prohibited for this user. Call denied ●	<b>System D:</b> Remote access FRL 3. ARS absorbs no digits, routes to PSTN pool. ●
<b>System D:</b> Receives outside dial-plan routed call to calling group. Too many callers are waiting and the call is routed to centralized VMS/AA.	555 7342	Call is sent to calling group 7771 with VMI conversion number (6999) <b>Route 1:</b> Integrated VMI routes to pool 6130, voice only. UDP route absorbs all digits and prepends 7771 (extension number for the centralized VMS/AA at System C).<	<b>System C:</b> Call rings into centralized VMS/AA for calling group 7342 and calling information indicates an outside call. When caller leaves message, Message Waiting light update is sent over the private network to Message Waiting receiver for the calling group on System D. ●

< = Call sent over tandem trunks      | = Call sent over PSTN      ● = Call ends

## Intersystem Calling

This topic illustrates how different types of calls are made and received in Scenario 2, using the extension numbers and extension equipment types shown in [Figure 2-3 on page 2-45](#).

[Table 2-12, page 2-55](#) shows how calls are made and displayed at different recipients' extensions within the private network. Notice that because the systems are connected by tandem tie trunks, calls from non-local extensions display as outside calls at recipients' extensions. For the centralized VMS/AA, this means that all calls are treated as outside calls and the centralized VMS/AA cannot provide different call handling and/or greetings based on the type of call. Contrast this display with those in Scenario 1, [Table 2-5, page 2-30](#).

Notice that because intersystem calls are made on tie trunks, transfers to non-local extensions do not return when the intended destination is busy or has Do Not Disturb activated, and no coverage is available. For Release 6.1 or later systems, when the automated attendant transfers a call to a non-local system, and the call is not answered within the fixed transfer redirect timeout (32 seconds), the call will stop ringing at the remote destination and be redirected to the extension on the transferring system programmed to receive redirected calls. This can be the first QCC queue, another extension, or an available calling group. Refer to the Programming Guide, "Redirect Outside Calls to Unassigned Extension Numbers" for details.

When Night Service is activated at System D, all calls route to the centralized VMS/AA on System C. The centralized VMS/AA offers customers the choice of leaving a general message for the customer service representative group or a message in an individual mailbox. Because of the time difference, the recorded messages must be carefully selected.

When a caller leaves a message for an extension on System D, Message Waiting light updates are sent over tie trunks in this private network. The updates are sent in-band as part of intersystem calls.

If all tie trunks are busy, when Message Waiting light updates are attempted, the updates are queued in the Message Waiting light queue behind any other earlier queued updates. All queued Message Waiting light updates are retained on the central system until a tandem T1-emulated tie trunk is available. Up to 1499 messages can be queued in the Message Waiting light queue. This may cause a delay in Message Waiting light update.



**Table 2-12. Intersystem Calling: Scenario 2**

Type of Call	Caller	Caller Dials	Recipient	Recipient Sees...
Non-local extension	System C: Ext. 4638 FRL=6	7342	System D Ext. 7342, MLX-5D®	TIE-TRK
Non-local extension	System D, Ext. 7377 FRL=3	4638	System C Ext. 4638, MLX-20L	TIE-TRK
Intersystem Remote Access	System C, Ext. 4638 FRL=6	326 + barrier code (with FRL 6) + *10	Routed via UDP Pattern 3, FRL 6, to System D for remote system programming	Not Applicable
Transfer of outside call to non- local extension	Outside to System C: Ext. 4632	<b>Transfer</b> 7377	System D Ext. 7377, MLX-10D, has Do Not Disturb on and no coverage. Caller hears busy tone.	Not Applicable
Transfer of outside PRI-ANI call to non-local extension	Outside to System C: Ext. 4646, PassageWay client. Display pops up customer information.	<b>Transfer</b> 7358  (Manual transfer using telephone)	System D Ext.7358, MLX-20L	TIE-TRK

*Continued on next page*

**Table 2-12. Intersystem Calling: Scenario 2, Continued**

Type of Call	Caller	Caller Dials	Recipient	Recipient Sees...
Transfer of outside PRI-ANI call to centralized VMS/AA	Outside to System D: Ext.7771	<b>Transfer</b> 7358	<p><b>System D:</b> Call is sent to integrated VMI calling group 7771 (with VMI conversion number 6999).                      Routed via UDP pattern 4, FRL=0, all digits absorbed, digits 7771 prepended.                      Call information sent to the integrated VMI calling group is outside call information.                      The centralized VMS/AA system answers. If caller leaves a message, the Message Waiting light updates are sent over the private network an available T1 tandem trunk.</p>	Not Applicable
Call from system user to check messages	System D: Ext 7342	7771	Centralized VMS/AA on System C	Not Applicable

### Scenario 3: Four Systems in a Series, Mixed Facilities

---

Like Scenario 1, this example discusses the planning and call-handling for private networking features and routing. It does not describe the business environment in any detail. In this scenario, the systems are connected in a linear fashion, creating a series configuration. Three systems are joined by tandem PRI facilities. A fourth system is connected to one of the others by analog tandem tie trunks.

**NOTE:**

It is recommended that PRI lines, rather than tie lines, be used between MERLIN LEGEND Communications systems in a private network that utilizes the Centralized Voice Mail feature. Refer to [Table 1-1, page 1-11](#) for advantages of PRI lines.

[Figure 2-4](#) shows this more complex private network, where three of the systems are geographically distant from one another. Systems J and M are peripheral systems because they do not connect two or more other networked systems.

Note the following general facts about this private network:

- All four systems are located in the same time zone. System managers ensure that date and time settings are the same at each system. In this way, SMDR reports from each system can trace the same call accurately and clearly as it crosses the private network. Since all the systems are in the same time zone, all activate Night Service simultaneously. The message on the automated attendant can change with the activation of Night Service on System L or stay the same, depending on configuration.
- System J is the only system that uses tandem tie trunks to connect to the system. It is directly connected to System K, which is nearby geographically and located in the same area code.
- System J cannot use the centralized VMS/AA because it is not directly connected to System L. System J must have its own VMS/AA if these services are required.
- The system manager at System K is the coordinating system manager for the private network. All changes are cleared through this person, who ensures that the changes do not interfere with private network operations. If changes at one system require changes at other systems as well, the System K manager sees that the proper modifications are made and that system forms are updated accordingly.
- Two of the systems (K and M) share the centralized VMS/AA on System L. System J has its own VMS/AA, but sends overflow coverage for calling groups to a QCC on System K.
- To avoid conflicts, the dial plan of each system is unique within the private network.
- Two systems have videoconferencing applications and use them for meetings.
- Two systems have PassageWay Telephony Services applications for use by fund-raisers.

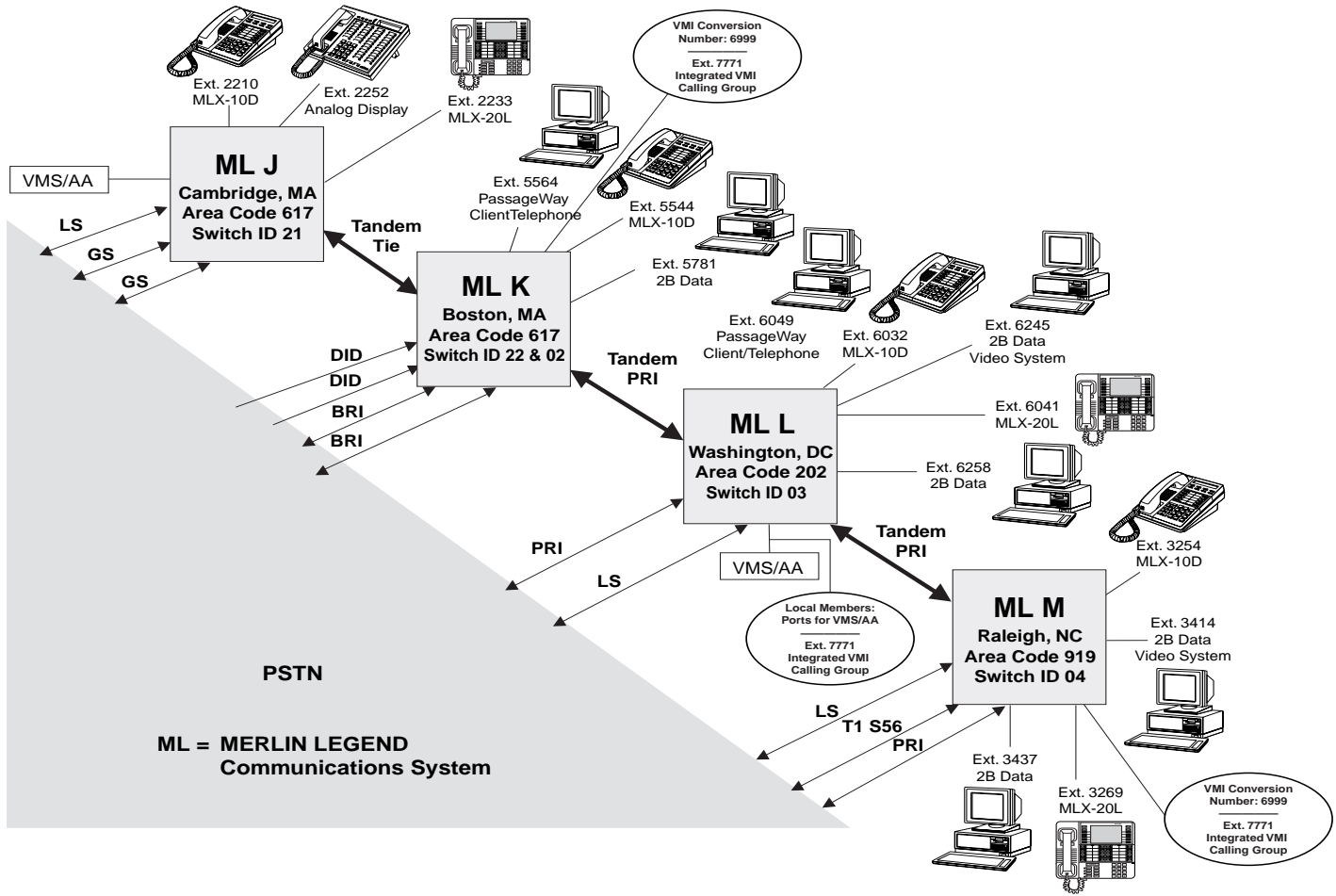

Figure 2-4. Scenario 3: Overview

## Non-Local Dial Plans and Facilities Planning

This section shows how non-local dial plans, calling groups, switch identifiers, UDP routing, ARS routing, and remote access are set up for each system. Not all details are provided for all facilities and extensions.

[Table 2-13, page 2-61](#) shows the applicable extension ranges, patterns, and routes for pools when people in one system call people at non-local dial plan extensions. It also shows routing of calls to the centralized VMS/AA. Some UDP routes are reserved for video and ISDN data workstations that communicate within the private network to hold videoconferences and to transfer large amounts of data at high speeds. Not all routes and patterns are shown.

Notice that System J has no UDP routes to reach digital data extensions at networked systems; because System J is connected by analog (E&M) tandem tie trunks, this is not practical. The customer has also restricted calls to System M.

[Table 2-14, page 2-63](#) shows how the remote system managers set up their local systems for internetwork calling. [Table 2-15, page 2-65](#) and [Table 2-16, page 2-66](#) show some routing details. As you review these tables, keep the following points in mind:

- Systems K, L, and M all convey calls to the PSTN from callers on non-local systems. Their remote access default COR for all non-tie trunks on Systems L and M is assigned an FRL of 6 for unrestricted use of local ARS routes. System K is more restrictive, applying an FRL of 4 to the default COR for all non-tie trunks. Like the other systems described in this chapter, all three use factory-set Disallowed List 7. The default COR setting requires barrier codes; the requirement is applied only to remote access calls received on local PSTN trunks (PRI dial-plan routed and/or DID) and to those made by entering a Remote Access code in the non-local dial plan. This way, system managers can control security on PSTN/intersystem remote access calls while allowing other calls across the private network. In addition, other remote access calls where the caller dials the Remote Access code also require barrier code entry.
- System K stipulates the same remote access default COR settings for all tie trunks as well. This allows System K to handle some local exchange calls for System J when local exchange calls are toll-free from System K. However, System J does not handle such calls for System K, because there is little business need for this arrangement. Furthermore, the additional outside facilities that would be required for System J do not justify this.
- ARS 6-Digit Tables are used to route some local exchange calls from System J to System K.
- System J does not convey any calls from other systems to the PSTN, so no special default COR remote access programming is needed.
- Because Systems J and K are close to one another but distant from the other two systems, Systems J and K do not have the same switch identifiers across the private network.

- System J does not require ARS toll-saving calling for all local system users to outside facilities connected to System L.
- A series configuration such as this one requires two tandem PRI facilities for the systems that connect to two other systems, in this case Systems K and L. This means that fewer outside facilities can be connected to these systems than to Systems M and J because the system's capacity of 80 lines/trunks (or three DS1 facilities) cannot be exceeded. Compare the outside facilities with those of Scenario 4 shown in [Figure 2-5 on page 2-75](#).
- In this series configuration, System L has centralized VMS/AA to serve Systems K and M respectively. Systems K and M are programmed for patterns that select pools that route to the centralized VMS/AA on the System L. System J does not have coverage to the centralized VMS/AA System L because it has its own VMS/AA and it is not possible to cover calls over more than one span between sender and receiver on the private network.
- Some calling groups on Systems K and M are configured to overflow to the centralized VMS/AA on System L, in the event that all extensions in a calling group are busy. If the overflow threshold or timeout is reached, the call will be routed to the centralized VMS/AA, at which point the caller may leave a message in the calling group's mailbox.
- Some calling groups on System J are configured to overflow to the QCC queue on System K. To route calls to the QCC at System K, a local calling group with a single non-local member must be created at System J. This non-local calling group member is the extension for the QCC queue (Listed Directory Number) at System K.

Table 2-13. UDP Extension Ranges: Scenario 3

System J Local Dial Plan: 2210-2259 Trunks: 8801-8880	System K Local Dial Plan: 5540-5569; 5770-5799 Listed Directory Number (QCC queue): 8800 Integrated VMI calling group for routing to Centralized VMS/AA: 7771 Trunks: 5801-5880	System L Local Dial Plan: 6030-6049; 6240-6269 Centralized VMS/AA: 7771 Trunks: 6801-6880	System M Local Dial Plan: 3250-3269; 3410-3449 Integrated VMI calling group for routing to Centralized VMS/AA: 7771 Trunks: 3801-3880
<b>Extension Range:</b> 5540-5568 Pattern: 01  Route 01 Pool=7210, tandem tie trunks FRL=0, Voice	<b>Extension Range:</b> 2210-2258 Pattern: 01  Route 01 Pool=4170, tandem tie trunks FRL=0, Voice	<b>Extension Range:</b> 5540-5569 Pattern: 01  Route 01 Pool=5330, tandem PRI trunks FRL=0, Both	<b>Extension Range:</b> 5540-5569 Pattern: 01  Route 01 Pool=8760, tandem PRI trunks FRL=0, Both
<b>Extension Range:</b> 6030-6049 Pattern: 01  Route 01 Pool=7210, tandem tie trunks FRL=0, Voice	<b>Extension Range:</b> 6030-6049 Pattern: 02  Route 01 Pool=4172, tandem PRI trunks FRL=0, Both	<b>Extension Range:</b> 5770-5799 Pattern: 05  Route 01 Pool=5335, tandem PRI trunks FRL=3, Data	<b>Extension Range:</b> 5770-5799 Pattern: 08  Route 01 Pool=8860, tandem PRI trunks FRL=3, Data
<b>Extension Range:</b> 3250-3269 Pattern: 03  Route 01 Pool=7211, tandem tie trunks FRL=4, Voice	<b>Extension Range:</b> 6240-6269 Pattern: 10  Route 01 Pool=4273, tandem PRI trunks FRL=2, Data	<b>Extension Range:</b> 2210-2259 Pattern: 02  Route 01 Pool=5331, tandem PRI trunks FRL=0, Voice	<b>Extension Range:</b> 2210-2259 Pattern: 02  Route 01 Pool=8761, tandem PRI trunks FRL=2, Voice

*Continued on next page*

**System M Local Dial Plan:**  
 3250–3269; 3410–3449  
 Integrated VMI calling  
 group for routing to  
 Centralized VMS/AA: 7771  
 Trunks: 3801-3880

**Extension Range:** 6030–6048  
 Pattern: 03  
 Route 01  
 Pool=8762,tandem PRI trunks  
 FRL=0, Both

**Extension Range:** 6240–6269  
 Pattern: 09  
 Route 01  
 Pool=8861, tandem PRI trunks  
 FRL=2, Both

**Extension Range:** 6999-6999  
 (VMI conversion number for  
 routing to centralized VMS/AA;  
 assigned as single member of  
 integrated VMI calling group  
 7771)  
 Pattern: 04  
 Route 01  
 Pool=8761, tandem PRI trunks  
 FRL=0, Voice  
 All dialed digits are absorbed  
 and the digits 7771 are  
 prepended

**System L Local Dial Plan:**  
 6030–6049; 6240–6269  
 Centralized VMS/AA: 7771  
 Trunks: 6801-6880

**Extension Range:** 3410–3449  
 Pattern: 06  
 Route 01  
 Pool=5336, tandem PRI trunks  
 FRL=2, Data

**Extension Range:** 3250–3269  
 Pattern: 03  
 Route 01  
 Pool=5333, tandem PRI trunks  
 FRL=0, Voice

**System K Local Dial Plan:**  
 5540–5569; 5770–5799  
 Listed Directory Number  
 (QCC queue): 8800  
 Integrated VMI calling  
 group for routing to  
 Centralized VMS/AA: 7771  
 Trunks: 5801-5880

**Extension Range:** 3410–3449  
 Pattern: 11  
 Route 01  
 Pool=4274, tandem PRI trunks  
 FRL=2, Data

**Extension Range:** 3250–3269  
 Pattern: 03  
 Route 01  
 Pool=4171, tandem PRI trunks  
 FRL=0, Voice

**Extension Range:** 6999-6999  
 (VMI conversion number for  
 routing to centralized VMS/AA;  
 assigned as single member of  
 integrated VMI calling group  
 7771)  
 Pattern: 04  
 Route 01  
 Pool=4172, tandem PRI trunks  
 FRL=0, Voice  
 All dialed digits are absorbed  
 and the digits 7771 are  
 prepended

**System J Local Dial Plan:**  
 2210–2259  
 Trunks: 8801-8880

**Extension Range:** 8800-8800  
 (for routing to QCC queue on  
 System K; assigned as single  
 member of calling group 7772)  
 Pattern: 01  
 Route 01  
 Pool=7210, tandem tie trunks  
 FRL=0, Voice





Table 2-14. Scenario 3: Facilities Planning, Calls Originating within the private network and Going to the PSTN

Component	System J: Cambridge, MA (Area Code: 617)	System K: Boston, MA (Area Code: 617)	System L: Washington, DC (Area Code: 202)	System M: Raleigh, NC (Area Code: 919)
<b>DS1 Switch Type</b>	Not applicable for analog tandem tie trunks	MERLIN LEGEND-PBX	MERLIN LEGEND-Ntwk	MERLIN LEGEND-PBX
<b>Switch Identifiers Programmed on This System</b>	22 for a system within 200 miles (System K)	21 for a system within 200 miles (System J) 03 for a system more than 200 miles away (System L)	02 for a system more than 200 miles away (System K) 04 for a system more than 200 miles away (System M)	03 for a system more than 200 miles away (System L)
<b>ARS Access Code</b>	9	9	9	9
<b>Remote Access Code and COR for UDP and ARS Routing via This System</b>	Remote Access Code: 889* All-tie and all non-tie Toll Restricted Barrier Code Required FRL=3	Remote Access Code: 289 All non-tie and all tie Outward Unrestricted Barrier Code Required (ignored for UDP extension and non-local ARS calls) Disallowed List 7 FRL=4	Remote Access Code: 389 All non-tie Outward Unrestricted Barrier Code Required (ignored for UDP extension and non-local ARS calls) Disallowed List 7 FRL=6 <sup>†</sup>	Remote Access Code: 489 All non-tie Outward Unrestricted Barrier Code Required (ignored for UDP extension and non-local ARS calls) Disallowed List 7 FRL=6 <sup>†</sup>

*Continued on next page*

**Table 2-14. Scenario 3: Facilities Planning, Calls Originating within the private network and Going to the PSTN, Continued**

Component	System J: Cambridge, MA (Area Code: 617)	System K: Boston, MA (Area Code: 617)	System L: Washington, DC (Area Code: 202)	System M: Raleigh, NC (Area Code: 919)
<b>Centralized VMS/AA</b>	Not applicable because not directly connected to System L by tandem trunks.	Integrated VMI calling group extension: 7771 VMI conversion number (non-local dial plan member): 6999 UDP routing over route 01, tandem PRI trunks, FRL=0, voice, all dialed digits are absorbed and the digits 7771 are prepended.	Integrated VMI calling group extension: 7771 Local dial plan members: Extensions for system ports used to connect centralized VMS/AA Message Waiting light updates for non-local subscribers are sent over the tandem PRI signalling D-channel	Integrated VMI calling group extension: 7771 VMI conversion number (non-local dial plan member): 6999 UDP routing over route 01, tandem PRI trunks, FRL=0, voice, all dialed digits are absorbed and the digits 7771 are prepended.
<b>QCC Coverage for Calling Group Overflow</b>	Auto Logout calling group extension: 7772 Non-local dial plan member: 8800 (Listed Directory Number — QCC queue on System K) UDP routing over route 01, tandem tie trunks, FRL=0, voice	Listed Directory Number (QCC queue): 8800	Not applicable	Not applicable

\* These are the factory settings. The remote access COR settings are not used for controlling ARS calling on PSTN facilities connected to this system. Such calls are not routed to this system.

† Local considerations may require a lower (more restrictive) FRL

System J: Cambridge, MA (Area Code: 617)

System K: Boston, MA (Area Code: 617)

Dialed or Rec'd Digits	Rte	Pool Type	Abs	Prep	FRL	Dialed or Rec'd Digits	Rte	Pool Type	Abs	Prep	FRL
91703	1	Tandem	0	9	1	91202	1	Tandem to Sys. L	0	9	1
	2	Local PSTN	0	0	5		2	Local PSTN	0	0	4
91202	1	Tandem	0	9	1	91703	1	Tandem to Sys. L	0	9	1
	2	Local PSTN	0	0	5		2	Local PSTN	0	0	5
91410	1	Tandem	0	9	2	91410	1	Tandem to Sys. L	0	9	3
	2	Local PSTN	0	0	5		2	Local PSTN	0	0	5
91919	1	Tandem	0	9	2	91919	1	Tandem to Sys. L	0	9	2
	2	Local PSTN	0	0	5		2	Local PSTN	0	0	5
9555 (some local exchanges)	1	Tandem	0	9	0	9555 (some local exchanges)	All	Local PSTN	0	9	0
	2	Local PSTN	0	0	1						
91617	All	Local PSTN	4	0	1	91617	All	Local PSTN	4	0	1
91508	All	Local PSTN	0	0	2	91508	All	Local PSTN	0	0	2

**Rte** = Sample route number (1= preferred routes; 2=secondary routes)  
**Abs** = Number of absorbed (deleted) digits

**Prep** = Prepend (prefixed) digits  
**FRL** = ARS Facility Restriction Level. For calls from the network tandem trunks, it is compared to default COR for the type of tandem trunk. For local system calls (including remote access calls) it is compared to the extension or barrier code FRL of the caller.

System L: Washington, DC (Area Code: 202)

System M: Raleigh, NC (Area Code: 919)

Dialed or Rec'd Digits	Rte	Pool Type	Abs	Prep	FRL	Dialed or Rec'd Digits	Rte	Pool Type	Abs	Prep	FRL
91617	1	Tandem to Sys. K	0	9	1	91202	1	Tandem	0	9	1
	2	Local PSTN	0	0	5		2	Local PSTN	0	0	3
91508	1	Tandem to Sys. K	0	9	2	91703	1	Tandem	0	9	2
	2	Local PSTN	0	0	5		2	Local PSTN	0	0	4
91919	1	Tandem to Sys. M	0	9	2	91410	1	Tandem	0	9	2
	2	Local PSTN	0	0	5		2	Local PSTN	0	0	5
91202	All	Local PSTN	4	0	0	91617	1	Tandem	0	9	2
91703	All	Local PSTN	0	0	2		2	Local PSTN	0	0	5
91410	All	Local PSTN	0	0	3	91508	1	Tandem	0	9	3
							All	Local PSTN	0	0	5
						91919	All	Local PSTN	4	0	0

**Rte** = Sample route number (1= preferred routes; 2=secondary routes)  
**Abs** = Number of absorbed (deleted) digits

**Prep** = Prepend (prefixed) digits  
**FRL**= ARS Facility Restriction Level. For calls from the network tandem trunks, it is compared to default COR for the type of tandem trunk. For local system calls (including remote access calls) it is compared to the extension or barrier code FRL of the caller.

## Routing for Outside Calls

This topic examines routing for hypothetical outside calls, to show how the system managers in Scenario 3 maximize cost benefits from the private network. As you study the example call routes in [Table 2-17, page 2-68](#), review the general setup as described earlier in this section.

Note the following facts about routing for outside calls in this scenario:

- Some DID calls that come into System K are actually destined for System L. In a private network such as this one where one system has blocks of DID numbers, digit manipulation can be used to route DID calls from one system to another. In this example, System K has purchased a block of DID numbers from a service provider.
- At Systems K, L, and M, users make and receive 2B data calls. If an outside 2B data call travels over PRI or BRI facilities and/or tandem PRI facilities only, it can take place up to 128 kbps. However, if it is routed over a PSTN T1 Switched 56 facility (such as the one connected to System M), the 2B data call can travel at a rate no higher than 112 kbps.
- A PRI dial-plan routed call can be sent across the private network to a telephone extension. If ANI information is available and the call traverses PRI facilities only, it can be displayed at the recipient's extension. DID calls do not provide calling party, but they do provide calling party name or number information.
- The call information signals for outside calls sent from System K or System M to the centralized automated attendant indicate an outside call. This allows a unique greeting and/or menu to be played.

Table 2-17. Outside Calls: Scenario 3

Originating or Receiving System	Dialed Digits	Local Routing	Non-Local Routing
<b>System J:</b> Ext. FRL: 1	9555-2258	<p><b>Route 1:</b> ARS Local Exchange Table routes to tandem trunk pool, FRL 0, prepends 9 &lt;</p> <p><b>Route 2:</b> If all lines in Route 1 are busy, ARS Area Code Table routes to local PSTN line/trunk pool, FRL 1.  </p>	<b>Route 1, System K:</b> Call is routed here for a lower cost local call. ARS absorbs no digits, routes to PSTN pool.
<b>System J:</b> Ext. FRL: 2	91919-555-2258	<b>Route 1:</b> ARS Area Code Table routes to local PSTN line/trunk pool, FRL 5. Call denied ●	No routing over private network
<b>System K:</b> Ext. FRL: 2	91202-555-5163	<p><b>Route 1:</b> ARS Area Code Table routes to PRI tandem trunk pool, FRL 1, prepends 9 &lt;</p> <p><b>Route 2:</b> If all lines in Route 1 are busy, ARS Area Code Table routes to local PSTN line/trunk pool, FRL 2, call permitted for this user.  </p>	<b>Route 1, System L:</b> ARS absorbs 4 digits (1202), routes to PSTN pool.
<b>System M:</b> Ext. FRL: 2	91617-555-5163	<p><b>Route 1:</b> ARS Area Code Table routes to tandem trunk pool, FRL 2, prepends 9. &lt;</p> <p><b>Route 2:</b> If all lines in Route 1 are busy, ARS Area Code Table routes to local PSTN pool, FRL 5, call prohibited for this user. Call denied ●</p>	<b>Route 1, System L:</b> ARS absorbs no digits, prepends 9, routes to PRI tandem trunk pool FRL 1 < connected to <b>System K</b> , which absorbs 4 digits (1617) and routes to local PSTN pool FRL 1.
DID call arrives at <b>System K</b>	555-6032	System K DID receives 6032, checks local dial plan, then finds number in non-local dial plan. Routes via UDP Pattern 2 to PRI tandem trunk pool FRL 0, 4172, Voice and Data <	<b>System L:</b> Voice call arrives at Ext. 6032, displays as outside call on tandem trunk: PRI-TRK ●

< = Call sent over tandem trunks      | = Call sent over PSTN      ● = Call ends

*Continued on next page*

Table 2-17. Outside Calls: Scenario 3, *Continued*

Originating or Receiving System	Dialed Digits	Local Routing	Non-Local Routing
Two outside dial-plan routed 64-kbps PRI 2B data calls arriving at <b>System M</b>	555-5781 dialed twice	For each call System M PRI dial-plan routing deletes 555, checks local dial plan, then finds number in non-local dial plan. Routes via UDP Pattern 8 to PRI tandem trunk pool 8760, Data, at 64 kbps, FRL 3. <	<b>System L:</b> Routes each call to PRI tandem trunk pool 5335 via Pattern 5 and Route 1 at 64 kbps, FRL 3 < connected to <b>System K:</b> Ext. 5781, digital 2B data workstation FRL 3 ●
<b>System K:</b> Ext. FRL 2, 2B data calls	91202-555-6249 dialed twice	<b>Route 1:</b> For each call ARS Area Code Table routes to tandem trunk pool 6249 at 64 kbps, FRL 1, prepends 9. <  <b>Route 2:</b> For each call ARS Area Code Table routes to local BRI PSTN line/trunk pool at 64 kbps, FRL 4, call prohibited for this user. ●	<b>Route 1, System L:</b> ARS absorbs 1202, routes to PSTN PRI line/trunk at 64 kbps.
Outside dial-plan routed PRI voice call arrives at <b>System K</b> and user is not available. Integrated VMI calling group provides coverage	555-5544	<b>System K:</b> PRI dial-plan routing deletes 555, checks local dial plan. Since user is not available, call is sent to integrated VMI calling group 7771 (has VMI conversion number 6999). The system finds the VMI conversion number in the non-local dial plan. UDP routing absorbs 6999 and prepends 7771 (System L's centralized integrated VMI calling group extension). Routes via UDP to tandem PRI trunk pool 8761.	<b>System L:</b> Call rings into centralized VMS/AA and calling information indicates an outside call for mailbox 5544. When the caller leaves a message, the Message Waiting light update is sent over the PRI signalling D-channel to extension 5544 on System K.

< = Call sent over tandem trunks      | = Call sent over PSTN      ● = Call ends

## Intersystem Calling

This topic illustrates how different types of calls are made and received in Scenario 3, using the extension numbers and extension equipment types shown in [Figure 2-4 on page 2-58](#).

[Table 2-18, page 2-71](#) shows how calls are made and displayed at different recipients' extensions within the private network. Notice how the displays vary depending upon the type of tandem trunks and PSTN facilities that carried the call. If the call traverses a tandem tie trunk, it displays as an outside call.

One outside call is included in [Table 2-18, page 2-71](#) to show how PRI-ANI information displays at the destination extension. Notice the differences among the calls received at PassageWay Telephony Services clients:

- The sixth call example is not an intersystem call, but is shown to illustrate the display that results at the destination CTI link extension.
- The last call example illustrates the use of transfer redirect across the private network. For Release 6. and later systems, when a centralized automated attendant transfers a call to a non-local extension, the transferring system monitors the call to ensure that it is answered. If the non-local extension is not available or the call is not answered within the fixed redirect interval (32 seconds), the call stops ringing at the remote destination and is redirected to an extension on the transferring system (the system with the centralized VMS/AA) that is programmed to receive redirected calls. This extension can be the first QCC queue, another extension, or a calling group (the call is directed to an available member and not sent to calling group coverage).

For example, the centralized VMS/AA on System L transfers a call to an unavailable extension on System M. After the redirect interval, the call is redirected to a QCC which is programmed to receive redirected calls on System L. The QCC operator can then provide assistance to the caller.

- If a PassageWay Telephony Services application uses the length of ANI/ICLID information to differentiate outside calls from inside calls, the non-local dial plan call displays as an inside call; the table shows an example. An outside call with four or fewer digits displays as an inside call.
- If the PassageWay Telephony Services application uses the presence of a trunk identifier to differentiate inside and outside calls, a non-local dial plan call displays as an outside call. The display depends upon the application.
- If the non-local dial plan recipient of a transfer or conference call is a PassageWay Telephony Services client, the recipient's display shows information about the initiator of the transfer or conference. ANI information about an original caller is not received. The table shows an example of a transfer.



Table 2-18. Intersystem Calling: Scenario 3

Type of Call	Caller	Caller Dials	Routed via...	Recipient	Recipient Sees...
Non-local extension	System K: Ext. 5564	3254	System L All PRI	System M Ext. 3254, MLX-10D, Name display	BROWN, K Ext.5564
Non-local extension	System L: Ext. 6041	2252	System K PRI and Tie	System J Ext. 2252, Analog multiline display	TIE-TRK
Non-local extension, 2B data	System L: Ext 6245	3414 twice	All PRI	System K Ext. 3414, Digital data workstation	Depends on video application
Non-local extension	System M: Ext. 3254	5564	All PRI	System K Ext. 5564, PassageWay client	MARK 3254*
Transfer of outside PRI-ANI call to non-local extension	Outside to System L: Ext. 6041	<b>Transfer</b> 5564	All PRI	System K Ext. 5564, PassageWay Client	PATEL, R 6041 ANI not delivered on transferred calls
Outside PRI-ANI dial-plan routed call to non-local extension	Outside to System M	555-6049	All PRI with PRI routing	System L Ext. 6049, PassageWay Client	PRI-TRK 919-555-1212*

*Continued on next page*

Table 2-18. Intersystem Calling: Scenario 3, Continued

Type of Call	Caller	Caller Dials	Routed via...	Recipient	Recipient Sees...
Outside PRI-ANI dial-plan routed call to local extension on System M. Extension is busy or unavailable. centralized VMS/AA provides coverage.	Outside to System M: ext 3254	555-3254	All PRI with PRI routing	<p><b>System M:</b> Call is sent to integrated VMI calling group 7771 (with VMI conversion number 6999). The system finds the group member in the non-local dial plan. Routes via UDP pattern 4 to tandem PRI trunk pool 8761. UDP routing absorbs 6999 and prepends 7771 (System L's centralized VMS/AA calling group extension). Call is answered by centralized VMS/AA on</p> <p><b>System L.</b> Calling information sent to centralized VMS/AA indicates outside call. If caller leaves a message, Message Waiting light is updated at extension 3254. The Message Waiting light update is sent over private network using PRI signalling D-channel.</p>	Not applicable

Continued on next page

**Table 2-18. Intersystem Calling: Scenario 3, Continued**

Type of Call	Caller	Caller Dials	Routed via...	Recipient	Recipient Sees...
<b>System L</b> Outside call transferred to non-local extension by centralized VMS/AA. The non-local extension is busy or doesn't answer.	Outside to centralized VMS/AA, transferred to ext 3254	<b>Transfer</b> 3254	<b>System L:</b> All PRI	<b>System L</b> , ext 3254 not responding. After timeout, call is sent to first QCC operator position on System L (programmed as redirect extension).	PRI-TRK

\* Actual PassageWay client display depends upon application. This entry shows the information that is sent to the extension.

## Scenario 4: Four Systems in a Star, Mixed Facilities

---

In this scenario, one MERLIN LEGEND Communications System acts as the hub and three systems are connected to it in a *star configuration* to the hub. The systems are linked by tandem PRI and analog tie facilities. [Figure 2-5 on page 2-75](#) shows this more complex private network.



### NOTE:

It is recommended that PRI lines, rather than tie lines, be used between MERLIN LEGEND Communications systems in a private network that utilizes the Centralized Voice Mail feature. Refer to [Table 1-1, page 1-11](#) for advantages of PRI lines.

Note the following general facts about this larger private network, which requires more coordination in order to set up:

- The systems span three different time zones. The private network is configured for the automated attendant on System E to provide Night Service coverage for all systems. Systems E and H go into Night Service before Systems F and G, therefore, the caller will hear the Night Service greeting. The Night Service greeting should be general enough to accommodate different time zones.
- System H, F, and G users and calling groups receive coverage from the centralized VMS/AA on the hub, System E.
- System H serves a warehousing and shipping operational facility. It has one loop-start line connected to the PSTN for emergency and power-failure backup purposes. For all other outside calls, System H uses PSTN facilities that are connected to other systems in the private network. It is located relatively near System E, but not in the same area code.
- System G is a small branch office that has fewer extensions and requires fewer private network facilities than the larger Systems E and F.
- The system manager at System E is the coordinating system manager for the private network. Any changes at local systems are cleared through this person, who ensures that the changes do not interfere with private network operations. If changes at one system require changes at all systems as well, the System E manager sees that the proper modifications are made and that system forms are updated accordingly.
- To avoid conflicts, the dial plan of each system is unique within the private network.

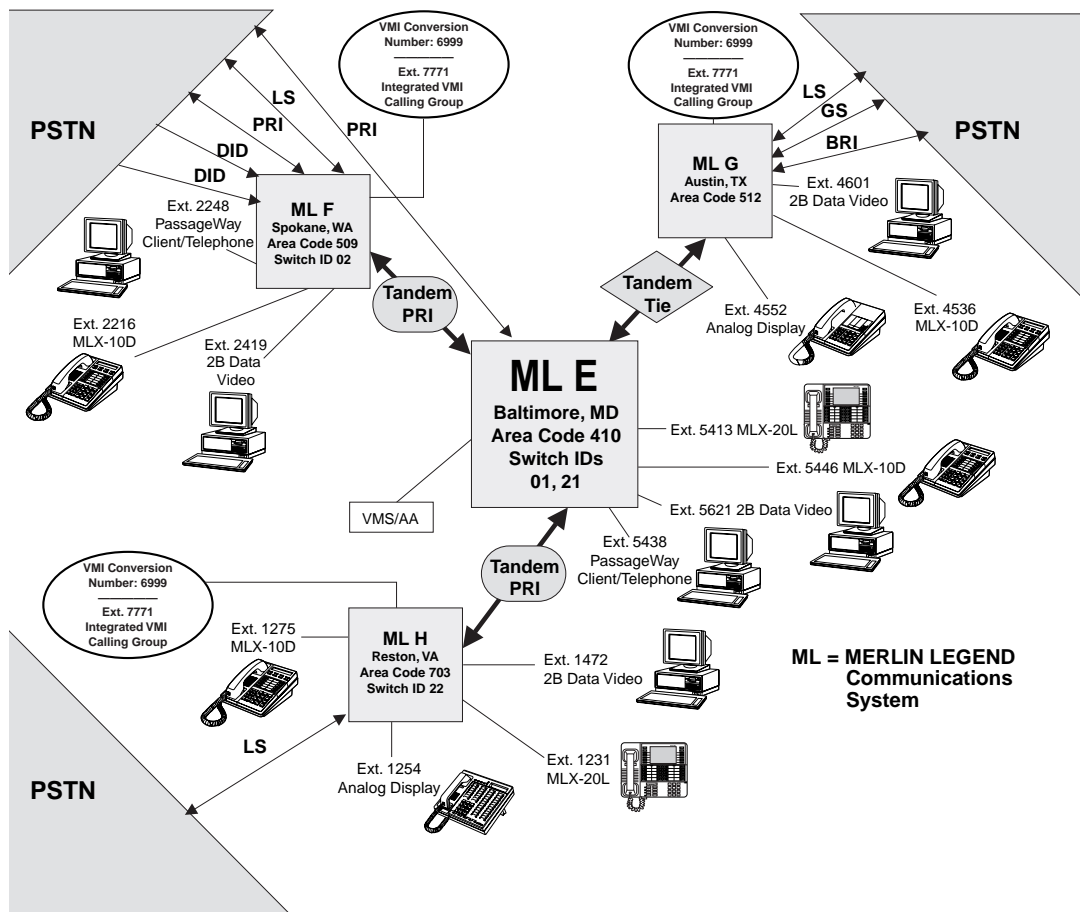

Figure 2-5. Scenario 4: Overview

- All systems have videoconferencing applications and use them for meetings. They also use other high-speed data applications.
- Two systems, located on opposite coasts, have PassageWay Telephony Services applications for use by telemarketers.
- Not all dial plan entries are necessarily shown for each system.
- The PRI to PSTN circuit to System E is fractional. The 100D module is installed in the last slot of the control unit, therefore only the first 20 ports are counted toward the system maximum of 80. However, the D-channel will still function.
- All systems share a centralized VMS/AA system located at System E.

## Non-Local Dial Plans and Facilities Planning

This section explains how non-local dial plans, calling groups, switch identifiers, UDP routing, ARS routing, and remote access are set up for each system. Not all details are provided for all facilities and extensions.

Intersystem calling is not illustrated in detail for Scenario 4, but [Table 2-19, page 2-79](#) shows the applicable extension ranges, patterns, and primary routes for tandem and PSTN facility pools when people in one system call people at non-local dial plan extensions. Some UDP routes are reserved for high-speed data/video calls between systems, and a pair of extension numbers (5610–5611) on the headquarters System E is dedicated to executive videoconferences. When considering intersystem calling, keep the following facts in mind:

- Intersystem voice calls to and from System G do not display calling name or number information at MLX display telephone or PassageWay recipients, because these calls travel over tandem tie trunks.
- Notice that because System G is connected to the private network by analog tandem tie trunks, its BRI facilities are used by users at other systems to call the single 2B data extension on System G. The 2B data extension on System G is a video system, and users there call only certain video extensions on other private network systems (only the executive video extension on System E is accessed, for example). If a System H user calls a 2B data extension on System G, the call is routed first over tandem PRI facilities to System E, which prepends the necessary digits and sends the call over the PSTN on a PRI facility. When the call arrives on the System G BRI facility, it is routed directly to the video system.
- Because tandem tie lines are used instead of PRI tandem trunks to connect system G to system E, inside calls to the centralized VMS/AA appear as outside calls. For the centralized VMS/AA, this means that all calls are treated as outside calls and the centralized VMS/AA cannot provide different call handling and/or greetings based on the type of call. Also, Message Waiting Light updates for non-local extensions compete with other voice and data calls for tie lines and touch tone receivers, and are queued with other calls, so there may be delays in Message Waiting light updates.



### NOTE:

It is recommended that PRI lines, rather than tie lines, be used between MERLIN LEGEND Communications systems in a private network that utilizes the Centralized Voice Mail feature. Refer to [Table 1-1, page 1-11](#) for advantages of PRI lines.

- Similarly, the System G users access its PSTN BRI facilities when they must reach 2B data extensions on other private network systems.

- To reach System G, the routes for intersystem voice calls direct them from Systems F and H via the hub, System E, where they are then sent to System G over tandem tie facilities. FRLs for routes to System G are slightly higher to avoid excessive call volume over the analog tandem tie trunks.



**NOTE:**

In Release 6.1 and later, it is important to note that coverage to the centralized VMS/AA from remote private network systems must be limited to only one span. This means that a call may only pass through one tandem trunk to the centralized VMS/AA on the hub system.

- Calls between extensions on Systems E, F, and H do display caller information, according to display preference settings, at the destination MLX display extensions.

[Table 2–20, page 2-82](#) shows how the system managers set up their local systems for use of local PSTN facilities and non-local PSTN facilities. Remote Access codes are not shown but are set up to be unique and unambiguous across the private network. As you review the table, keep the following points in mind:

- To avoid confusion and for future planning purposes, tandem trunks and pools of tandem trunks are also numbered uniquely and unambiguously.
- System H users do not make Interexchange calls. The system's loop-start line is assigned to the main pool, Pool 70.



**CAUTION:**

*Unless networked systems are co-located, each system should have at least one loop-start line connected to the PSTN. The line is required to allow connection of a power-failure telephone to the Power-Failure Transfer (PFT) jack on a module as a power outage backup and for correct routing of emergency and other N11 (911, 411, etc.) calls. To ensure that the correct services are reached, if the loop-start line is used for emergency or other N11 calls, it should be assigned to the main pool. In this case, inter-exchange (IXC) calls determine the number of loop-starts required. Refer to Feature Reference guide for details on the PFT feature.*

- The hub system, System E, can support only two tandem PRI trunks to connect to Systems H and F, because it also requires a number of outside facilities. It is using the maximum system capacity of 80 lines/trunks. Its 100D module is in the last circuit module position in the control unit and uses only 20 lines of its 23-line capacity. There is no emergency loop-start line connected to the system, therefore other power failure arrangements should be made. Compare the limitations with those of Scenario 3, shown in [Figure 2–4 on page 2–58](#).

- To insure correct routing for emergency and other N11 calls, and for interexchange calls (IXC), assign PRI trunks to the main pool.
- Using tandem PRI trunks, an additional system could be connected to either System F or System H. Were an additional system connected to System G, its features and performance would be limited by the tandem tie trunks that link System G to the private network.
- Default remote access COR settings are not shown. As in earlier scenarios, the system managers require barrier codes for remote access calls via PSTN facilities and those dialed as intersystem calls using a Remote Access code; this requirement is ignored for ARS routing across the private network. Instead, the default COR FRL is compared to the UDP or ARS route before a call leaves the local system to reach another private network system or the PSTN.
- A detailed table of ARS routing is not shown; this has been described in earlier scenarios. The ARS access code for all systems is 9.
- The integrated VMI calling group (at each remote system) used to route calls to the centralized VMS/AA is set up as described in "Implementation of Centralized VMS/AA" in Chapter 5.



**Table 2-19. UDP Extension Ranges: Scenario 4**

<b>System E Local Dial Plan:</b> 5400-5499; 5610-5669 <b>Centralized VMS/AA: 7771</b> <b>Trunks 5801-5880</b>	<b>System F Local Dial Plan:</b> 2200-2259; 2400-2449 <b>Integrated VMI calling Group</b> <b>for Routing to Centralized</b> <b>VMS/AA: 7771</b> <b>Trunks 2801-2880</b>	<b>System G Local Dial Plan:</b> 4530-4599; 4600-4601 <b>Integrated VMI calling Group</b> <b>for Routing to Centralized</b> <b>VMS/AA: 7771</b> <b>Trunks 4801-4880</b>	<b>System H Local Dial Plan:</b> 1230-1299; 1450-1499 <b>Integrated VMI calling Group</b> <b>for Routing to Centralized</b> <b>VMS/AA: 7771</b> <b>Trunks 1801-1880</b>
<b>Extension Range:</b> 2200-2259 Pattern: 01  Route 01 Pool=4230, tandem PRI trunks FRL=0, Both	<b>Extension Range:</b> 5400-5499 Pattern: 01  Route 01 Pool=5260, tandem PRI trunks FRL=0, Both	<b>Extension Range:</b> 5400-5499 Pattern: 01  Route 01 Pool=8240, tandem tie trunks FRL=2, Voice	<b>Extension Range:</b> 5400-5499 Pattern: 01  Route 01 Pool=6700, tandem PRI trunks FRL=0, Voice
<b>Extension Range:</b> 2400-2449 Pattern: 10  Route 01 Pool=4250, tandem PRI trunks FRL=1, Data	<b>Extension Range:</b> 5610-5611 Pattern: 07  Route 01 Pool=5281, tandem PRI trunks FRL=5, Data	<b>Extension Range:</b> 5610-5611 Pattern: 11  Route 01 Pool=8001, PSTN BRI trunks FRL=5, Data, prepends digits 1410xxx for PRI dial-plan routing on System E.	<b>Extension Range:</b> 5610-5611 Pattern: 05  Route 01 Pool=6800, tandem PRI trunks FRL=5, Data
<b>Extension Range:</b> 4530-4599 Pattern: 02  Route 01 Pool=4310, tandem tie trunks FRL=3, Voice	<b>Extension Range:</b> 5612-5669 Pattern: 01  Route 01 Pool=5260, tandem PRI trunks FRL=0, Both	<b>Extension Range:</b> 2200-2259 Pattern: 01  Route 01 Pool=8240, tandem tie trunks FRL=2, Voice	<b>Extension Range:</b> 5612-5669 Pattern: 03  Route 01 Pool=6701, tandem PRI trunks FRL=0, Both

*Continued on next page*

Table 2-19. UDP Extension Ranges: Scenario 4, Continued			
<b>System E Local Dial Plan:</b> 5400-5499; 5610-5669 <b>Centralized VMS/AA: 7771</b> <b>Trunks 5801-5880</b>	<b>System F Local Dial Plan:</b> 2200-2259; 2400-2449 <b>Integrated VMI calling Group</b> <b>for Routing to Centralized</b> <b>VMS/AA: 7771</b> <b>Trunks 2801-2880</b>	<b>System G Local Dial Plan:</b> 4530-4599; 4600-4601 <b>Integrated VMI calling Group</b> <b>for Routing to Centralized</b> <b>VMS/AA: 7771</b> <b>Trunks 4801-4880</b>	<b>System H Local Dial Plan:</b> 1230-1299; 1450-1499 <b>Integrated VMI calling Group</b> <b>for Routing to Centralized</b> <b>VMS/AA: 7771</b> <b>Trunks 1801-1880</b>
<b>Extension Range:</b> 4600-4601 Pattern: 13  Route 01 Pool=4001, PSTN PRI trunks FRL=5, Data, prepends digits 1512xxx for routing to System G, where calls are routed directly over a PSTN BRI line to a data extension.	<b>Extension Range:</b> 4530-4599 Pattern: 02  Route 01 Pool=5361, tandem PRI trunks FRL=3, Voice		<b>Extension Range:</b> 4530-4599 Pattern: 02  Route 01 Pool=6700, tandem PRI trunks FRL=4, Voice
<b>Extension Range:</b> 1230-1299 Pattern: 03  Route 01 Pool=4330, tandem PRI trunks FRL=0, Both	<b>Extension Range:</b> 4600-4601 Pattern: 13  Route 01 Pool=5361, tandem PRI trunks FRL=3, Data. Calls are routed to System E and then to System G via PSTN.	<b>Extension Range:</b> 2400-2449 Pattern: 11  Route 01 Pool=8001, PSTN BRI trunks FRL=5, Data, prepends digits 1509xxx for PRI dial-plan routing on System F.	<b>Extension Range:</b> 4600-4601 Pattern: 13  Route 01 Pool=6800, tandem PRI trunks FRL=5, Data
<b>Extension Range:</b> 1450-1499 Pattern: 03  Route 01 Pool=4330, tandem PRI trunks FRL=1, Both	<b>Extension Range:</b> 1230-1299 Pattern: 02  Route 01 Pool=5261, tandem PRI trunks FRL=0, Voice	<b>Extension Range:</b> 1230-1299 Pattern: 05  Route 01 Pool=8240, tandem tie trunks FRL=2, Voice	<b>Extension Range:</b> 2200-2259 Pattern: 01  Route 01 Pool=6700, tandem PRI trunks FRL=0, Voice

*Continued on next page*

Table 2-19. UDP Extension Ranges: Scenario 4, Continued	System E Local Dial Plan: 5400-5499; 5610-5669 Centralized VMS/AA: 7771 Trunks 5801-5880	System F Local Dial Plan: 2200-2259; 2400-2449 Integrated VMI calling Group for Routing to Centralized VMS/AA: 7771 Trunks 2801-2880	System G Local Dial Plan: 4530-4599; 4600-4601 Integrated VMI calling Group for Routing to Centralized VMS/AA: 7771 Trunks 4801-4880	System H Local Dial Plan: 1230-1299; 1450-1499 Integrated VMI calling Group for Routing to Centralized VMS/AA: 7771 Trunks 1801-1880
	<p><b>Extension Range:</b> 1450-1499                      Pattern: 01</p> <p>Route 01                      Pool=5260, tandem PRI trunks                      FRL=0, Both</p>	<p><b>Extension Range:</b> 1450-1499                      Pattern: 13</p> <p>Route 01                      Pool=8001, PSTN BRI trunks,                      FRL=5, Data, prepends digits                      1410xxx for PRI dial-plan routing                      on System E, manipulates the                      incoming digits to route to System                      H.</p>	<p><b>Extension Range:</b> 2400-2449                      Pattern: 03</p> <p>Route 01                      Pool=6701, tandem PRI trunks                      FRL=0, Both</p>	
	<p><b>Extension Range:</b> 6999-6999                      (VMI conversion number for                      routing to centralized VMS/AA;                      assigned as single member of                      integrated VMI calling group                      7771) Pattern 03</p> <p>Route 01                      Pool=8361, tandem PRI trunks                      FRL=0, Voice                      All dialed digits absorbed                      digits 7771 prepended</p>	<p><b>Extension Range:</b> 6999-6999                      (VMI conversion number for                      routing to centralized VMS/AA;                      assigned as single member of                      integrated VMI calling group                      7771) Pattern 03</p> <p>Route 01                      Pool=8240, tandem PRI trunks                      FRL=0, Voice                      All dialed digits absorbed                      digits 7771 prepended</p>	<p><b>Extension Range:</b> 6999-6999                      (VMI conversion number for                      routing to centralized VMS/AA;                      assigned as single member of                      integrated VMI calling group                      7771) Pattern 04</p> <p>Route 01                      Pool=6700, tandem PRI trunks                      FRL=0, Voice                      All dialed digits absorbed                      digits 7771 prepended</p>	

Component	System E: Baltimore, MD (Area Code: 410)	System H: Reston, VA (Area Code: 703)
<b>DS1 Switch Type</b>	MERLIN LEGEND-Ntwk	MERLIN LEGEND-PBX
<b>Switch Identifiers Programmed on This System</b>	22 for a system within 200 miles (System H) 02 for a system more than 200 miles away (System F) 03 for a system more than 200 miles away (System G)	21 for a system within 200 miles (System E)
<b>ARS Routing: Calls to Local or Nearby Area Codes</b>	All FRLs are set to low values for these calls. Four digits are absorbed for 410 area code calls, and no digits are absorbed for 301 and 703 area code calls.	The factory-set Special Numbers Table and Dial 0 Table must use the main pool, which includes the system's loop-start line and directs emergency (911) and other special numbers calls to the correct local services.  All other routes, including Toll Table, specify tandem trunk pools with prepending of 9.  The default Local Table uses tandem trunks and prepends 91703.

*Continued on next page*

**Table 2–20. Scenario 4: Facilities Planning, Calls Originating within the Network and Going to the PSTN: System E and H,**  
 Continued

Component	System E: Baltimore, MD (Area Code: 410)	System H: Reston, VA (Area Code: 703)
<b>ARS Routing: Calls to Area Code of Non-Local System (Absorb = 0; Prepend = 9)</b>	<p>For primary routes serving calls to area codes 509 and 512, the FRL is 0.</p> <p>The FRL is higher for primary routes to areas near but not in the same area code as one of the other private network systems. A 218 or 713 area code route (Houston) via the smaller tandem tie trunk pool has an FRL of 4.</p> <p>Secondary routes using the PSTN have FRLs as high as 6.</p>	<p>Routing specifies pools of tandem PRI facilities, which are also used for non-local extension calling.</p> <p>The FRL is 0, 1, or 2 for calls using private network area codes: 410, 512, and 509. FRLs are higher for other area codes, depending upon the time of day and toll costs.</p>
<b>Centralized VMS/AA</b>	<p>Integrated VMI calling group extension: 7771</p> <p>Local dial plan members: Extensions for system ports used to connect centralized VMS/AA</p> <p>Message Waiting light updates for non-local subscribers at System F and System H are sent over the tandem PRI signaling D-channel; Message Waiting light updates for non-local subscribers at System G are sent over the tandem tie trunks;</p>	<p>Integrated VMI calling group extension: 7771</p> <p>VMI conversion number (non-local dial plan member: 6999</p> <p>UDP routing over route 01, tandem PRI trunks, FRL=0, voice, all dialed digits are absorbed and the digits 7771 are prepended.</p>

**Table 2-21. Scenario 4: Facilities Planning, Calls Originating within the Network and Going to the PSTN, Systems F and G**

Component	System F: Spokane, WA (Area Code: 509)	System G: Austin, TX (Area Code: 512)
<b>DS1 Switch Type</b>	MERLIN LEGEND-PBX	Not applicable for tandem tie trunks
<b>Switch Identifiers Programmed on This System</b>	01 for a system more than 200 miles away (System E)	01 for a system more than 200 miles away (System E)
<b>ARS Routing: Calls to Local or Nearby Area Codes</b>	Digit string: 1509: Area Code Table, Route to pool(s) of local PSTN facilities, FRL=0, Absorb=4	Digit string: 1512: Area Code Table, Route to pool(s) of local PSTN facilities, FRL=0, Absorb=4
<b>ARS Routing: Calls to Area Code of Non-Local System or to Area Codes Near Non-Local System (Absorb = 0)</b>	<p>For primary routes serving calls to area codes 410, 703, and 512, the FRLs are set to low values.</p> <p>The FRL is higher for primary routes to areas near but not in the same area code as one of the other private network systems. For instance, a 703 area code route via a tandem PRI pool has an FRL of 1.</p> <p>Secondary routes using the PSTN have FRLs as high as 6.</p>	<p>For primary routes serving calls to area codes 410, 703, and 509, the FRLs are set to low values.</p> <p>The FRL is higher for primary routes to areas near but not in the same area code as one of the other private network systems. For instance, a 301 area code (Maryland) route via the tandem tie pool has an FRL of 2.</p> <p>Secondary routes using the PSTN have FRLs as high as 6.</p>
<b>Centralized VMS/AA</b>	<p>Integrated VMI calling group extension: 7771</p> <p>VMI conversion number (non-local dial plan member: 6999</p> <p>UDP routing over route 01, tandem PRI trunks, FRL=0, voice, all dialed digits are absorbed and the digits 7771 are prepended.</p>	<p>Integrated VMI calling group extension: 7771</p> <p>VMI conversion number (non-local dial plan member: 6999</p> <p>UDP routing over route 01, tandem PRI trunks, FRL=0, voice, all dialed digits are absorbed and the digits 7771 are prepended.</p>

## Routing for Outside Calls

This topic examines routing for hypothetical outside calls, to show how the system managers in Scenario 4 maximize cost benefits from the private network. As you study the example call routes in [Table 2-22, page 2-86](#), review the general setup as described in [Table 2-20, page 2-82](#) and [Table 2-21, page 2-84](#).

Note the following facts about routing for outside calls in this scenario:

- Local calls made from System H go out over PSTN trunks connected to System E, in a different area code. Although System H users do make local calls, most of their calls are within the private network for this operations site. ARS allows the prepending of the local 703 area code.
- System E, as the hub, has separate trunk pools for tandem PRI and tandem tie trunks connected to different systems. They are used for non-local extension calling as well as routing of outside incoming and outgoing calls.
- When a video workstation user on System G must call a video extension on another private network system, the call is made as a toll call and is routed at 128 kbps over the local BRI facilities. In this scenario, such a call could be as a dial-plan routed call to either System E or System F. Even a call destined for System E could be made to System F, then routed to System E.
- All systems share the centralized VMS/AA on System E.
- When the Night Service is activated in System F, G, or H, and on trunks programmed to ring into calling groups, the call is routed to the centralized VMS/AA on System E.

Table 2-22. Outside Calls: Scenario 4

Originating or Receiving System	Dialed Digits	Local Routing	Non-Local Routing
<b>System H:</b> Ext. FRL: 0	9555-2258	ARS Local Exchange Table routes to tandem trunk pool, FRL 0, prepends 91703 <	<b>System E:</b> ARS absorbs no digits, routes to PSTN pool.
<b>System H:</b> Ext. FRL: 2	9411	Call routed to local main pool loop-start line.	Not applicable
<b>System H:</b> Ext. FRL: 2	91410-555-2258	ARS Area Code Table prepends 9 and routes to tandem trunk pool, FRL 0 <	<b>System E:</b> ARS absorbs 4 digits (1410), routes to PSTN pool.
<b>System G:</b> Ext. FRL: 1	91509-555-4111	<b>Routes 1:</b> ARS Area Code Table routes to tandem tie trunk pool, FRL 1 <  <b>Routes 2:</b> If all lines in Route 1 are busy, ARS Area Code Table routes to local PSTN pool, FRL 3, call denied. Caller can turn on Selective Callback and queue for Route 1. ●	<b>Route 1, System E</b> routes to tandem PRI pool connected to System F. < <b>System F</b> absorbs 4 digits (1509), routes to local PSTN pool.
<b>System E:</b> Ext. FRL: 4	91218-555-2163	<b>Routes 1:</b> ARS Area Code Table routes to tandem tie trunk pool, FRL 4, prepends 9. <  <b>Routes 2:</b> If the caller has Automatic Callback enabled and all lines in Route 1 are busy, ARS Area Code Table routes to local PSTN line/trunk pool, FRL 5, call prohibited for this user. The call is automatically queued for Route 1. ●	<b>Route 1, System G:</b> ARS absorbs no digits, routes to local PSTN pool.

< = Call sent over tandem trunks      | = Call sent over PSTN      ● = Call ends

*Continued on next page*



Table 2–22. Outside Calls: Scenario 4, *Continued*

Originating or Receiving System	Dialed Digits	Local Routing	Non-Local Routing
DID call arrives at <b>System F</b>	555-5438	<b>System F</b> DID receives 5438, checks local dial plan, then finds number in non-local dial plan. Routes via UDP Pattern 1 to PRI tandem trunk pool 5260, Voice and Data <	<b>System E:</b> Voice call arrives at Ext. 5438, PassageWay client, which does not receive ANI. ●
PRI-ANI call arrives at <b>System F</b>	555-5446	<b>System F</b> PRI dial-plan routing deletes 555, checks local dial plan, then finds number in non-local dial plan. Routes via Pattern UDP Pattern 1 to PRI tandem trunk pool 5260, Voice and Data <	<b>System E:</b> Voice call arrives at Ext. 5446, PassageWay client, which receives calling party number. ●
Outside call arrives on <b>System G</b> trunk programmed in Night Service group covered by centralized VMS/AA. The system is in Night Service.	555-7775	<b>System G:</b> Since system is in Night Service, call is sent to integrated VMI calling group 7771 (has VMI conversion number 6999). The system finds the group member in the non-local dial plan. Routes via UDP to tandem PRI trunk pool 8240. UDP routing absorbs 6999 and prepends 7771 (System E's centralized integrated VMI calling group extension).<	<b>System E:</b> The call rings into the centralized VMS/AA and is handled by the automated attendant. ●
Outside dial plan routed PRI voice call arrives on <b>System F</b> and the user is not available; Integrated VMI calling group provides coverage.	555-2216	<b>System F:</b> PRI dial-plan routing deletes 555, checks local dial plan. Since user is not available, call is sent to integrated VMI calling group 7771 (has VMI conversion number 6999). The system finds the member in non-local dial plan. Routes via UDP route 01 to tandem PRI trunk pool 8361. UDP routing absorbs 6999 and prepends 7771 (System E's centralized VMS/AA integrated VMI calling group extension). <	<b>System E:</b> Call rings into centralized VMS/AA and calling information indicates an outside call to mailbox 2216. When the caller leaves a message, the Message Waiting light update is sent over a private network PRI D-channel to extension 2216 on System F. ●

< = Call sent over tandem trunks      | = Call sent over PSTN      ● = Call ends

## Scenario 5: Large System Hub

---

In this scenario, two MERLIN LEGEND Communications Systems are linked to a hub DEFINITY ECS or DEFINITY ProLogix Solutions system in a star configuration. Rather than repeating points made in earlier scenarios, this section concentrates on the unique features of the Scenario 5 configuration. [Figure 2-6 on page 2-89](#) shows how the system is arranged.



### NOTE:

DEFINITY ECS or DEFINITY ProLogix Solutions features and operations are beyond the scope of this guide. This scenario discusses the private network from the MERLIN LEGEND Communications Systems' perspective.

Note the following general facts about this private network:

- The systems are located in two different time zones.
- Only tandem PRI facilities connect the systems.
- The configuration takes advantage of the greater line/trunk capacity of the hub system. Systems O and N primarily use outside PSTN facilities connected to System A (DEFINITY ECS or DEFINITY ProLogix Solutions).
- The system manager at System O is the coordinating system manager for the private network. Any changes at local systems are cleared through this person, who ensures that the changes do not interfere with private network operations. If changes at one system require changes at other systems as well, the System O manager sees that the proper modifications are made and that system forms are updated accordingly.
- Systems O and A are located on the same corporate campus. System O serves the corporation's data processing and back office operations and transfers data to and from the System A headquarters system.
- Because System O is located in the same building as System A, all its calls are routed via the private network. The System O loop-start line is used only in the event of a power failure. The tandem PRI trunks are assigned to System O's main pool. When a Special Numbers call is made, the system automatically prepends the ARS access code of System A. Emergency 911 and information 411 calls can reach the correct local services.



### CAUTION:

*Unless networked systems are co-located, each system should have at least one loop-start line connected to the PSTN. The line is required to allow connection of a power-failure telephone to the Power-Failure Transfer (PFT) jack on a module as a power outage backup and for correct routing of emergency and other N11 (911, 411, etc.) calls. To ensure that the correct services are reached, if the loop-start line is used for emergency or other N11 calls, it should be assigned to the main pool. In this case, inter-exchange (IXC) calls determine the number of loop-starts required. Refer to Feature Reference guide for details on the PFT feature.*

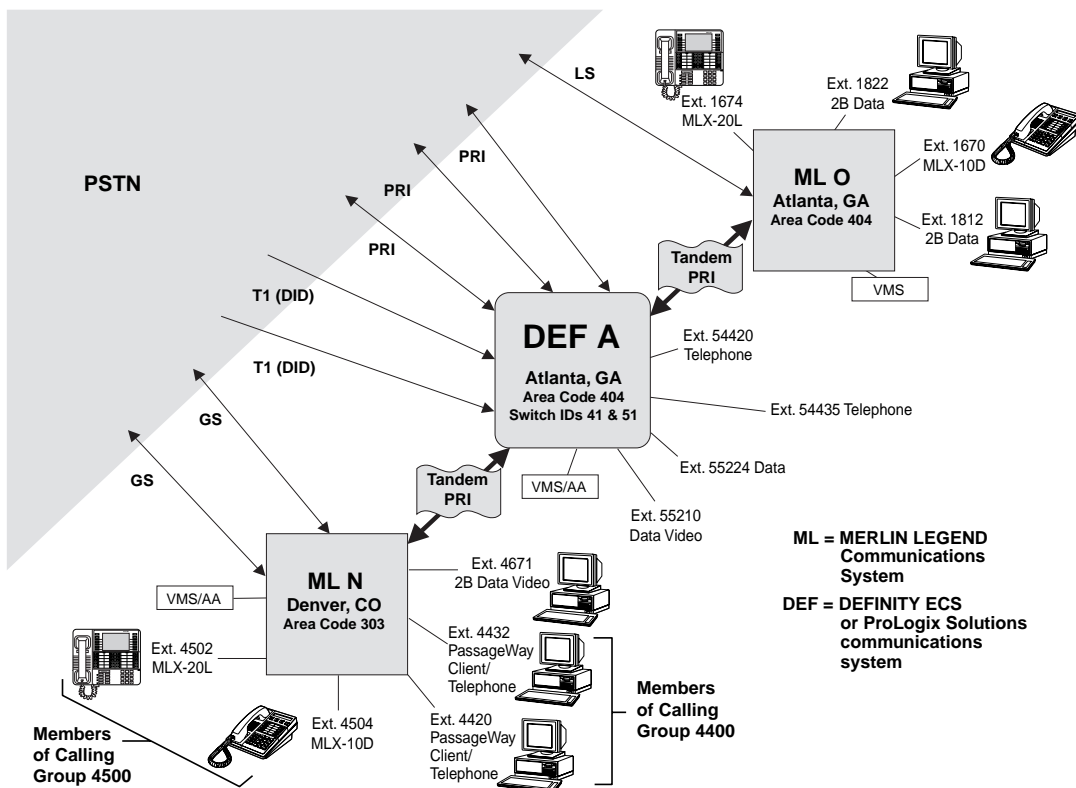

Figure 2-6. Scenario 5: Overview

- System N is a support and service center with busy incoming call traffic entering System N from System A PSTN facilities. Customers receiving technical support pay a high fee for this service and expect rapid and responsive service.
- Systems N and A have videoconferencing applications and use them for meetings.
- Because centralized VMS/AA is not supported in a mixed private network consisting of DEFINITY ECS or DEFINITY ProLogix Solutions and MERLIN LEGEND Communications systems, each system has its own voice mail and/or auto attendant application.

## Non-Local Dial Plans and Facilities Planning

This section summarizes non-local dial plans, switch identifiers, UDP routing, and ARS routing for each system. Not all details are provided for all facilities and extensions. Remote access information has been discussed in earlier scenarios.

[Table 2-23, page 2-92](#) shows some applicable extension ranges, patterns, and routes for pooled facilities when people in one system call people at another private network system. Some UDP routes are reserved for video and data calls.

System O users do not access video extensions on System N; these extensions are not included in the System O non-local dial plan. Similarly, no high-speed 2B data is sent from System N to System O. Any such data is reviewed at headquarters (System A) before it is sent to back-office operations at System O.

To avoid numbering conflicts, system managers at Systems N and O program the first 4 digits of the System A 5-digit DEFINITY ECS or DEFINITY ProLogix Solutions extension numbers into their non-local dial plans. For example, one extension number block on System A is 54400–54499 (see [Table 2-23, page 2-92](#)). If the last four digits were programmed into the non-local dial plan extension ranges of Systems O and N, the range would be 4405–4495, matching extension numbers on System N. Therefore, this range would be denied on System N and ambiguous on System O. Instead, users at all three systems dial System A extensions in the same way, using five digits. Systems O and N simply route calls on the first four digits dialed, and the fifth digit is sent to the DEFINITY ECS or DEFINITY ProLogix Solutions system for local dial-plan routing. In this case, dialed digits should be administered to 5.



### NOTE:

DID (Direct Inward Dialing) and PRI dial plan routing supports routing to 1-to 4-digit numbers. If incoming calls must reach 5-digit DEFINITY ECS or DEFINITY ProLogix Solutions system extension numbers, digit manipulation can be performed via UDP routing. However, it is best if DID lines are connected directly to the DEFINITY ECS or DEFINITY ProLogix Solutions system.

[Table 2–24, page 2-93](#) is an overview of how the system managers set up their systems for internetwork use of PSTN facilities. To avoid repetition, details are not provided. As you review the table, keep the following points in mind:

- Network calls going out to the PSTN are not routed through Systems N and O. Even when a System O caller needs to reach the 303 area code (rare), he or she uses PSTN trunks originating at System A. The ground-start lines/trunks connected to System N are used for local calling by System N users. Because of volume pricing benefits for OUTWATS services, System O and System A users make toll calls only via System A, even when calling a toll number in Colorado.
- On System N support agents use a PassageWay Telephony Services application that receives calls on PRI dial-plan routed facilities connected to System A and directed to their calling group, Ext. 4400. This arrangement allows them to receive screen pop of customer database information based on the ANI calling party number. Because this calling group number is not included in the System A non-local dial plan, System A users cannot make intersystem calls to the group. They can reach calling group members by dialing their individual extension numbers.
- Customer service agents on System N receive customer calls via T1-emulated DID lines connected to System A and routed to their calling group, Extension 4500. Non-local users do not usually call this group; if they need to reach an agent, they call the agent's individual extension.

Table 2-23. UDP Extension Ranges: Scenario 5

System A Local Dial Plan: 54400-54499; 55200-55260*	System O Local Dial Plan: 1600-1699; 1800-1899	System N Local Dial Plan: 4400-4599; 4600-4699 Calling Groups: 4400 (PassageWay clients) and 4500 (MLX extensions only)
<b>Extension Range:</b> 4401-4599 Voice and data, no restrictions	<b>Extension Range:</b> 5440-5449 Pattern: 01 Route 01 Pool=70, FRL=0, Voice, no digit prepending or deletion	<b>Extension Range:</b> 5440-5449 Pattern: 01 Route 01 Pool=8200, FRL=0, Both, no digit prepending or deletion
<b>Extension Range:</b> 4400-4400 Restricted from use by people on the local system	<b>Extension Range:</b> 5520-5526 Pattern: 02 Route 01 Pool=70, FRL=3, Data, no digit prepending or deletion	<b>Extension Range:</b> 5520-5526 Pattern: 02 Route 01 Pool=8300, FRL=3, Data, no digit prepending or deletion
<b>Extension Range:</b> 4600-4699 Data only, restricted to video and data users	<b>Extension Range:</b> 4401-4599 Pattern: 03 Route 01 Pool=70, FRL=0, Both	<b>Extension Range:</b> 1600-1699 Pattern: 01 Route 01 Pool=8400, FRL=0, Both
<b>Extension Range:</b> 1600-1699 Voice and data, no restrictions		
<b>Extension Range:</b> 1800-1899 Data only, restricted to video and data users		

\* The information in this column does not reflect actual DEFINITY ECS or DEFINITY ProLogix Solutions system programming. It only shows the result of that programming from a MERLIN LEGEND Communications System perspective.

Table 2-24. Scenario 5: Facilities Planning, Calls Originating within the Private Network and Going to the PSTN

Component	System A: Atlanta, GA (Area Code: 404)	System O: Atlanta, GA (Area Code: 404)	System N: Denver, CO (Area Code: 303)
<b>DS1 Switch Type Programmed on this System</b>	Private Network	MERLIN LEGEND-Ntwk	MERLIN LEGEND-Ntwk
<b>Switch Identifiers Programmed on This System</b>	Not applicable	51 for a system that is within 200 miles and is not a MERLIN LEGEND Communications System (System A)	41 for a system that is more than 200 miles away and is not a MERLIN LEGEND Communications System (System A)
<b>ARS Access Codes</b>	9	9	9
<b>ARS Routing: Calls to Local or Nearby Area Codes</b>	DEFINITY ECS or DEFINITY ProLogix Solutions system manager determines appropriate restrictions.	All programmable routes (Default Local, Default Toll, Dial 0 tables) specify the main pool of tandem PRI trunks. The Special Numbers Table routes emergency calls to the correct local services and also routes IXC calls through System A. All ARS tables must prepend a 9 (ARS access code).	Area Code Tables specify routing to PRI tandem trunk pools connected to System A for calls to other Colorado area codes as well as to more distant area codes.
<b>ARS Routing: Calls to Distant Area Codes</b>	No calls are routed through other systems, even calls to the 303 (Denver, CO) area code.	All routing specifies the main pool, 70, where all tandem PRI facilities are connected. FRLs are adjusted according to the cost of the call and the job requirements of the user.	To reach customers, agent outcalls are routed to PSTN PRI B-channels connected to System A, which subscribes to OUTWATS services for this purpose. The FRL for these routes is 2.

\* DEFINITY ECS and DEFINITY ProLogix Solutions systems do not have a Switch Type setting. The Interface field on such a system identifies the type of the DEFINITY ECS or DEFINITY ProLogix Solutions system, not the type at the other end of the tandem trunk as on MERLIN LEGEND Communications Systems. If the Interface field specifies *Network*, as it typically might, the MERLIN LEGEND Communications Systems specify MERLIN LEGEND-Ntwk. If the Interface field specifies *User*, the MERLIN LEGEND Communications Systems are programmed with the MERLIN LEGEND-PBX setting.

## Routing for Outside Calls

This topic examines routing for hypothetical incoming and outgoing outside calls, to show how the system managers in Scenario 5 maximize cost benefits from the private network. As you study the example call routes in [Table 2-25, page 2-95](#), review the general setup as described in [Table 2-24, page 2-93](#).

Note the following facts about routing for outside calls in this scenario:

- The largest number of incoming PSTN calls are directed to System N calling groups. However, System A does receive outside calls for marketing and corporate personnel who are local users.
- A dial-plan routed PRI facility on System A receives outside data calls for an extension on System O that is dedicated to the purpose of electronic data interchange (EDI).
- System N agents make outgoing calls to customers via OUTWATS lines connected to System A.



Table 2-25. Outside Calls: Scenario 5

Originating or Receiving System	Dialed Digits	Local Routing	Non-Local Routing
<b>System O:</b> Ext. FRL: 1	91303-555-3333	ARS Area Code Table routes to main pool, FRL 2, call denied. ●	None
<b>System N:</b> Ext. FRL: 3	91404-555-2258	ARS Area Code Table routes to tandem trunk pool, FRL 2.<	<b>System A:</b> ARS Area Code Table routes to outgoing PRI lines, performing necessary digit manipulation
<b>System A</b> receives 2 incoming data calls at 64 kbps.	555-1822 twice at 64 kbps	PRI dial-plan routes to tandem trunk pool connected to System O <	<b>System O:</b> 2B data calls are routed to 2B data extension 1822 at 128 kbps. ●
<b>System A</b> receives incoming DID call.	1404-555-4500	DID routes to tandem trunk pool connected to System N <	<b>System N:</b> Call goes to Ext. 4500 customer service calling group, where the agent at Ext. 4504 answers. ●
<b>System A</b> receives incoming PRI dial-plan routed call with ANI.	555-4400	Call is identified as destined for non-local extension and is routed to tandem trunk pool connected to System N <	<b>System N:</b> Call goes to Ext. 4400 technical support calling group, where the agent at Ext. 4432 (PassageWay client) answers and receives screen pop information about the customer. ●
<b>System N</b> remote access caller dials into System N on ground/start line programmed for dedicated remote access.	1303-555-4200 plus remote access barrier code. Then the caller dials 1670. The barrier code FRL is 3.	The system searches the local and non-local dial plan and compares the remote access barrier code FRL of 3 with the UDP route FRL of 0. Call is routed to the tandem trunk pool System A. <	System A finds the extension number in the non-local dial plan and routes the call to the tandem trunk pool connected to System O.< The call is received at Ext. 1670, MERLIN LEGEND O. ●

< = Call sent over tandem trunks      | = Call sent over PSTN      ● = Call ends

## Intersystem Calling

[Table 2-26, page 2-97](#) illustrates dialing and recipient screen displays for calling among extensions in Scenario 5. Note the following facts about intersystem calling in this scenario:

- The full 5-digit DEFINITY ECS or DEFINITY ProLogix Solutions extension numbers display at recipient extensions on the MERLIN LEGEND Communications Systems.
- The PassageWay Telephony Services application on System N displays UDP-routed calls as inside calls.
- PassageWay Telephony Services clients on System N cannot receive screen pop with the original caller information on a call that is transferred from System A. Instead, they receive information about the transfer originator. When such a transfer is made, the originator reviews the PRI-ANI information on his or her digital display telephone. Then the originator makes a transfer with consultation to a specific PassageWay Telephony Services client extension, telling the user at the extension what the calling party digits are. This allows the System N technician to bring up the customer information manually on his or her screen.
- MERLIN LEGEND Communications System users dial the full 5-digit DEFINITY ECS or DEFINITY ProLogix Solutions extension numbers, but the systems perform routing based on the first four digits.

In systems earlier than Release 6.0, Version 11, when a MERLIN LEGEND Communications System user calls an extension on System A, it is important to dial the fifth digit of the DEFINITY ECS or DEFINITY ProLogix Solutions extension number within two seconds of dialing the fourth digit, for correct routing.

For Release 6.0, Version 11 and later systems, programming the number of dialed digits as 5 makes this restriction unnecessary and speeds call setup time.

Table 2-26. Intersystem Calling: Scenario 5

Type of Call	Caller	Caller Dials	Routed via...	Recipient	Recipient Sees...
Non-local extension	System O: Ext. 1674	4502	System A All PRI	System N Ext. 4502, MLX-20L, Name and number display	PAYROLL 1674
Non-local extension	System N: Ext. 4504	54435	All PRI, digits 5443; recipient system directs to correct extension	System A: Telephone Ext. 54435	Depends upon DEFINITY ECS or DEFINITY ProLogix Solutions programming
Non-local calling group	System A: Ext. 54435	4482	All PRI	System N Ext. 4482, MLX-20L, Name display	MERSON Ext.54435
Non-local extension	System O: Ext. 1670	4420	All PRI	System N Ext. 4420, PassageWay client	1670*
Transfer with consultation to non-local extension	System A: Ext. 54420	<b>Transfer</b> 4432	All PRI	System N Ext. 4432, PassageWay client	54420*
Transfer with consultation to non-local extension	System N: Ext. 4420, PassageWay client	<b>Transfer</b> 1674 manually using telephone, not the PC	All PRI	System O Ext. 1674, MLX-20L, Number display	PRI-TRK 4420

\* This is only an example of information sent to the PassageWay client; the actual screen display is different and depends upon the application and how it is configured.



## Feature Interactions

# 3

---

This topic summarizes the ways that MERLIN LEGEND Communications System features work across private networks. For detailed descriptions of the features mentioned in this section, see the *Feature Reference*.

### Account Code Entry

---

Account codes entered on the local system are reported by Station Message Detail Recording (SMDR) on the local system, but are not passed across the private network. In Release 6.1 and later systems, for the SMDR record to print, the SMDR UDP option must be set to log UDP calls.

Users can enter account codes for private network calls.

When Forced Account Code Entry is programmed, a user can still dial a non-local extension without entering an account code.

### Alarm

---

System alarms must be on the local system. An **Alarm** button on an operator console responds to the local system.

## Allowed/Disallowed Lists

---

The system manager helps prevent toll fraud by assigning a Disallowed List to the default COR for tie and/or non-tie trunks (the factory Disallowed List 7 is recommended). The Disallowed List should be programmed to include 900,976, and other types of calls that the user should not be allowed to call. When a call is routed from one system to another in a private network, the called system processes the call without a barrier code and consults the Disallowed List in order to permit or forbid the call. A Disallowed List can be used in this way to restrict calls that originate from another system in the private network.

Allowed and Disallowed Lists are ignored by the local system when placing private network Uniform Dial Plan (UDP) calls to an extension in a non-local dial plan.

## Authorization Code

---

The Authorization code feature allows a user to pick up another user's telephone, enter his or her authorization code, and complete a call with the restrictions that apply to the user's own telephone (home extension). For private network calls, the user's home extension FRL is used to allow or disallow the call. The Authorization code feature can only be activated from an extension on the same system as the user's home extension.

## Auto Answer All

---

A user with an analog multiline telephone can activate Auto Answer All to allow private network calls to be answered by a device connected to a General Purpose Adaptor (GPA).

## Auto Answer Intercom

---

Auto Answer Intercom (analog multiline telephones only) does not work for private network calls. When a receiver with an analog multi-line wants private network calls to be answered by a device it must be connected to a GPA.

## Auto Dial

---

Non-local extension numbers can be programmed on outside Auto Dial buttons but not on inside Auto Dial buttons.

## Automatic Route Selection (ARS)

---

To help prevent toll fraud, ARS access codes for other networked systems must not be assigned to the non-local dial plan; the local ARS access code cannot be assigned to the non-local dial plan. For example, if the ARS access code is 9, extension ranges such as 9000–9039 cannot be assigned. It is recommended that the ARS access code be the same for all systems in a private network.

For ARS calls over another system's PSTN lines/trunks, the system manager programs ARS to prepend the non-local ARS access code and send it over private network trunks to the non-local system (the ARS code is accepted over tandem facilities, but not on incoming calls over PSTN trunks). Depending on how ARS is programmed at the non-local system, calls may be sent to yet another private network system before they are sent out over the PSTN.

In a private network, system managers program ARS to direct calls over the most cost-effective routes in the whole private network. For example, calls that are in the local calling area or area code of a non-local system can be sent out using PSTN lines/trunks connected to that system. At the non-local system, Remote Access operation is used to accept or reject such a call (see ["Remote Access" on page 21](#) for more information) for routing to the PSTN.



### SECURITY ALERT:

*The ARS non-local access code must not be programmed into the non-local dial plan. It is the responsibility of the switch where ARS calls originate to prevent toll fraud.*

The Special Numbers Table, Dial 0 Table, Default Local Table, and the Default Toll Table need to be programmed to prepend the remote system's ARS code. In networked systems, when the main pool contains tandem trunks, the local system automatically prepends its own ARS access code before sending 101xxxx equal-access Interexchange (IXC) calls across the private network. In this case, the local and remote system ARS access codes *must* match for proper routing to PSTN trunks connected to the remote system.



### CAUTION:

*Unless networked systems are co-located, each system should have at least one loop-start line connected to the PSTN. The line is required to allow connection of a power-failure telephone to the Power-Failure Transfer (PFT) jack on a module as a power outage backup and for correct routing of emergency and other N11 (911, 411, etc.) calls. To ensure that the correct services are reached, if the loop-start line is used for emergency or other N11 calls, it should be assigned to the main pool. In this case, inter-exchange (IXC) calls determine the number of loop-starts required. Refer to Feature Reference guide for details on the PFT feature.*

Extension Facility Restriction Levels (FRLs) are applied only to calls while they are on the local system, and are compared both to UDP routes and to ARS routes. For example, if a UDP route FRL is 1 and the caller's extension FRL is 0, the caller is unable to use the route, because the route FRL is higher than the extension FRL. Similarly, if a caller is using ARS to call over another networked system's PSTN facilities, the extension FRL is compared only with the local ARS route and its value must be equal to or greater than the route FRL value. Once a call arrives at a non-local system, the extension FRL has no effect. The remote system compares the FRL for its default COR for tie or non-tie trunks with that of the FRL of the next chosen route, as described in ["Remote Access Default Class-of-Restriction Settings" on page 6](#).

Additional information about ARS is included in ["Automatic Route Selection \(ARS\)" on page 7](#). In addition, Chapter 2, "Call-Handling Scenarios," includes many routing examples.

## Barge-In

---

Barge-In does not work for calls on a non-local system in a private network.

## Callback

---

Callback queuing works for lines/trunks connected to the caller's local system, including private network tandem trunks. When a call is sent across the private network and a non-local system's extensions or trunks are busy, the caller cannot queue the call using Callback.

When an extension with Automatic Callback activated originates a call to a non-local extension and the local system's trunks are busy, the call is queued at the local system's first route and the caller hears callback tone. If the caller is using ARS or the non-local dial plan to call out over trunks connected to a remote system and the outside facilities at the remote system are busy, the caller hears the fast busy tone. The caller hears the busy tone if he or she is calling a busy non-local dial plan extension. Neither call activates callback queuing because the caller is not connected to the system from which the busy condition originates.

For Release 6.1 and later systems, when a call is routed to a calling group with a non-local member and the local system's trunks are busy, the call is automatically queued for the first route even when the caller has not activated Automatic Callback. Once a trunk becomes available, the system notifies the user and completes the call. If the caller has Automatic Callback active and hangs up before trunks are available, the call remains queued for an available trunk until a trunk becomes available or the caller cancels the Callback request. If the caller does not have Automatic Callback active and hangs up before trunks are available, the call is disconnected.



## Caller ID

---

For 6.1 and later systems, Caller ID and Automatic Number Identification (ANI) information is conveyed across the private network when PRI tandem trunks are used to route the call **and** under the following conditions:

- The call is transferred using a DSS with one-touch transfer with automatic completion.
- The call is received on a PSTN trunk assigned to ring directly into a calling group with a non-local member.
- The call is received on a Personal Line and the principal user has activated Forward to a non-local extension and the Forward Delay option is set to one ring.
- The call is transferred to a user that has activated Forward to a non-local extension and the Forward Delay option is set to one ring.

For Release 6.0 systems, Remote Call Forwarding can be used in combination with Caller ID on a loop-start PSTN line connected to a networked system's 800 LS-ID line/trunk module (loop-start ID delay must be on). To pass Caller ID information across the network when a call is transferred, set the Remote Call Forwarding Delay to one ring. Transfer of the call must be completed before the call is forwarded.

For 6.0 and later systems, Caller ID and ANI information is not conveyed across the private network under the following conditions:

- The call is routed over T-1-emulated tie trunks or analog (E&M) tie trunks.
- A call is manually transferred by a user or is transferred by an automated attendant.

## Calling Restrictions

---

Outward restrictions, toll restrictions, Allowed/Disallowed Lists, Night Service restrictions, Extended Station Status restrictions, and the prohibition of trunk-to-trunk transfers do not apply to calls made to extensions in the non-local dial plan. These restrictions are still active for other calls.

To prevent toll fraud, dial-access to pools must not be permitted for pools of private network trunks.



### CAUTION:

*Unless networked systems are co-located, each system should have at least one loop-start line connected to the PSTN. The line is required to allow connection of a power-failure telephone to the Power-Failure Transfer (PFT) jack on a module as a power outage backup and for correct routing of emergency and other N11 calls. To ensure that the correct services are reached, if the loop-start line is used for emergency or other N11 calls, it*

*should be assigned to the main pool. In this case, IXC calls determine the number of loop-starts required. Refer to Feature Reference guide for details on the PFT feature.*



**NOTE:**

VMI ports default to FRL=0. To allow the VMS/AA to transfer calls across the private network, the VMI ports' FRL should be set to 3.

## Camp-On

---

Camp-On does not work for calls to non-local dial plan extensions.

## Centralized Voice Messaging (Release 6.1 and Later Systems)

---

The following features work differently for centralized VMS/AA than for local VMS/AA systems:

- Only MERLIN LEGEND systems can share a centralized VMS. A DEFINITY ECS or DEFINITY ProLogix system cannot share the MERLIN LEGEND centralized VMS/AA and MERLIN LEGEND systems cannot share a DEFINITY system VMS. However, automated attendant systems can transfer to non-local extensions on any system.
- Only the MERLIN LEGEND Mail, Messaging 2000, Intuity AUDIX, and IS-III AUDIX Voice Power voice mail systems can be used as the centralized VMS/AA. Other voice mail systems are not supported for Centralized Voice Mail, even though they may work as local voice mail systems.
- For Release 6. and later systems, when a centralized automated attendant transfers a call to a non-local extension, the transferring system monitors the call to ensure that it is answered. If the non-local extension is not available or the call is not answered within the fixed redirect interval (32 seconds), the call stops ringing at the remote destination and is redirected to an extension on the transferring system (the system with the centralized VMS/AA) that is programmed to receive redirected calls. This extension can be the first QCC queue, another extension, or a calling group (the call is directed to an available member and not sent to calling group coverage).



**NOTE:**

Calls transferred by the VMS/AA to a calling group with a non-local member, and all UDP routes are busy, will go to the redirect destination upon transfer completion. If a transferred call travels over a loop-start or ground-start line to the PSTN, it will not return for redirection.

### 3 Feature Interactions

#### Computer Telephony Integration (CTI) Link

Page 3-7

- To use Direct Voice Mail, the calling extension and the called extension must be on the same system.
- Leave Word Calling only works only if the calling extension, called extension, and covering voice mail for the called extension are on the same system. For 6.1 and later systems, when a centralized VMS is located on a remote system from the calling extension and called extension, incorrect confirmation messages and no error tones may indicate that Leave Word Calling succeeded but no message is sent to the called extension.
- Return Call for MLX and analog multiline telephones does not work across the private network.
- For Coverage Inside and Coverage VMS OFF, non-local dial plan calls are treated as outside calls.
- When Night Service is routed to a centralized VMS/AA in a different time zone, or where the offices have different hours, the service received (automated attendant greeting) depends on the time where the centralized VMS/AA is located. The automated attendant greetings should be programmed appropriately.
- A QCC operator can provide overflow coverage for an integrated VMI calling group on the system with the centralized VMS/AA. In this case, the operator will hear call information signals (touch-tones) meant for the voice messaging system indicating that you need more VMI ports.
- When a caller leaves a message or when a non-local subscriber retrieves all messages, the centralized VMS/AA sends the Message Waiting light updates across the private network.

## Computer Telephony Integration (CTI) Link

---

In a private network, operation for calls in PassageWay Telephony Services applications depends upon the application implementation as well as the type of private networked trunks (PRI or tie) that carry calls.

- For an outgoing call, if the PassageWay Telephony Services application uses the length of a destination telephone number order to differentiate PSTN calls from UDP calls, a PassageWay Telephony Services client displays a non-local extension call in the same way as it does inside calls.
- For an outgoing call, if the PassageWay Telephony Services application uses receipt of the *Network Reached event* to differentiate PSTN calls from inside calls, a PassageWay Telephony Services client displays a non-local extension call or other UDP-routed call in the same way as it does an outside call made to the PSTN.
- For an incoming call, if the PassageWay Telephony Services application uses the length of Automatic Number Identification (ANI) information to differentiate PSTN calls from UDP calls, a PassageWay Telephony Services client displays a non-local dial plan call as an inside call.

- For an incoming call, if the PassageWay Telephony Services application uses the presence of a trunk identifier in the *delivered event* to differentiate PSTN calls from UDP calls, a PassageWay Telephony Services client displays a non-local dial plan call in the same way it does a PSTN call.
- For an incoming PSTN call that enters the private network on a PRI trunk with an ANI of length shorter than seven digits and crosses PRI tandem trunks only, the recipient PassageWay Telephony Services client display depends on the PassageWay Telephony Services application implementation:
  - If the Passageway Telephony Services application does not strip leading zeros, the recipient Passageway Telephony Services client displays in the ANI information any leading zeros needed to make the information seven digits long.
  - If the Passageway Telephone Services application strips leading zeros, the recipient Passageway Telephony Services client displays the ANI information in its original length. The call displays as an inside or outside call depending on whether ANI information or a trunk identifier in the *delivered event* is used to differentiate the call.

If the non-local dial plan recipient of a transfer or conference call is a PassageWay Telephony Services client, the recipient's display shows caller information about the conference or transfer originator, not any other caller.

Users at CTI-linked PassageWay Telephony Services extensions must use the telephones at their extensions to make transfers to non-local dial plan extensions or to add conferees to a conference. They cannot use their PassageWay applications. A PassageWay Telephony Services client display does not provide an indication when a non-local conferee is dropped.

Collected digits are not sent across the private network.

The examples in Chapter 2, "Call-Handling Scenarios," provide details about and examples of how PassageWay Telephony Services clients operate in a private network.

## Conference

---

Calls to a non-local dial plan extension are treated as outside calls for the purpose of conferencing. Each non-local conference participant who is added takes up one of the two outside calls permitted in a conference. For example, if a user has added two outside calls to a conference, it is not possible to add a non-local extension.

## Coverage

---

In Release 6.0, calls arriving for extensions at one system cannot be covered by extensions or calling groups on a non-local system.

For Release 6.0 and later systems, non-local dial plan calls are treated as outside calls by the system and by Selective Coverage features: Coverage Inside and Coverage VMS Off.

In Release 6.1 and later, the Group Calling feature is enhanced to allow a calling group to have a single non-local member that is used to route calls to a remote system. A calling group containing a single non-local member can be used for many of the same purposes as a calling group containing only local extensions. This includes Group Coverage across a private network to a centralized VMS/AA, non-local calling group, QCC queue, DLC, or any individual extension on a remote MERLIN LEGEND, DEFINITY ECS or DEFINITY ProLogix system, or to the PSTN via UDP routing.

To ensure that VMS/AA calls transferred across the private network have time to go to coverage if not answered, it is recommended that group coverage ring delay for each sender be set to three rings or less.

## Digital Data Calls

---

Digital data calls between networked systems must travel over PRI tandem trunks or T1-emulated tie trunks programmed for data. 2B data is supported when two B-channels or T1 channels are available. UDP routes for digital data calls over tandem PRI trunks can specify voice and data or data only service. UDP routes for pools of T1-emulated tie facilities must specify data only. On tandem PRI facilities, 128-kbps 2B data speeds are supported. T1-emulated tie trunks programmed for data support 112-kbps 2B data speeds.

If you are using fractional point-to-point T1 facilities as tandem tie trunks, you can program some channels for data-only; remaining channels can be dedicated to voice only.

## Direct-Line Console (DLC)

---

In Release 6.1 and later systems, a system operator with a DLC can use DSS buttons to make or transfer calls to non-local extensions. However, the LEDs associated with the DSS buttons do not go on when a non-local extension user goes off hook.



### **SECURITY ALERT:**

*To prevent toll fraud, private trunks should not be assigned as personal lines on a DLC, nor should a DLC be given dial access to private trunk pools. See the Feature Reference for additional information.*

## Direct Station Selector (DSS)

---

In Release 6.0, DSS buttons cannot be used to access or monitor non-local dial plan extensions.

In Release 6.1 and later systems, DSS buttons can be used to make or transfer calls to non-local extensions. However, the LEDs associated with the DSS buttons do not go on when a non-local extension user goes off hook.

See the Feature Reference for additional information.

## Direct Voice Mail

---

Direct Voice Mail can be used for local extensions only and cannot be used for non-local extensions. The person calling and the person being called must be on the same system. In Release 6.1 and later systems, if a local extension is covered by a centralized VMS/AA at a remote system, Direct Voice Mail can be used to place or transfer a call directly to a local extension's voice mailbox on the centralized VMS/AA without ringing the telephone.

## Directories

---

Non-local dial plan extension numbers cannot be included in a local Extension Directory. However, non-local extension numbers can be included in Personal and System Directories.

You cannot use a non-local system's System Directory to make calls. A System Directory can be used only by local users.

## Display

---

Tandem PRI trunks can provide caller information at the destination MLX multiline display telephone. The system manager programs this capability for each MLX display extension, to allow display of the label (name), extension number, or both. The system supports the display of 5-digit DEFINITY ECS or DEFINITY ProLogix Solutions extension numbers, although longer DEFINITY ECS or DEFINITY ProLogix Solutions labels may be truncated on MERLIN LEGEND Communications System displays, which support a maximum of 7 characters for name labels and 7 characters for extension number labels.

When a non-local extension calls the Listed Directory Number (LDN), the Queued Call Console (QCC) at the remote system receives the LDN display.

If an incoming PRI call with ANI is routed over PRI tandem trunks only, the trunk label and ANI information can display at the MLX display telephone extension where the call arrives.

For 6.1 and later systems, the destination MX display telephone extension displays the trunk label and Caller ID/Automatic Number Identification (ANI) information across the private network when PRI tandem trunks are used to route the call **and** under the following conditions:

- The call is transferred using a DSS with one-touch transfer with automatic completion.
- The call is received on a PSTN trunk assigned to ring directly into a calling group with a non-local member.
- The call is received on a Personal Line and the principal user has activated Forward to the non-local MLX extension and the Forward Delay option is set to one ring.
- The call is transferred to a user that has activated Forward to a non-local MLX extension and the Forward Delay option is set to one ring.

When a call is transferred and travels over PRI tandem trunks, the display shows the transferring extension. A forwarded call arriving at a remote extension displays as though the caller had reached the extension directly in the following situations:

- If the transfer was completed before the call was forwarded, the ANI/ICLID displays.
- If a system operator transfers a call to a non-local extension using a DSS with one-touch transfer with automatic completion (automatic extended call completion for QCC), the ANI/ICLID information appears on MLX display phones when the call is routed over PRI tandem trunks.

For Release 6.0 systems, Remote Call Forwarding can be used in combination with Caller ID on a loop-start PSTN line connected to a networked system's 800 LS-ID line/trunk module (loop-start ID delay must be on). To pass Caller ID information across the network when a call is transferred, set the Remote Call

Forwarding Delay to one ring. Transfer of the call must be completed before the call is forwarded.

For 6.0 and later systems, Caller ID and ANI information is not conveyed across the private network and at MLX display telephones the trunk label only is displayed under the following conditions:

- The call is routed over T-1-emulated tie trunks or analog (E&M) tie trunks.
- A call is manually transferred by a user or is transferred by an automated attendant.

For most redirected calls from the private network, the display will be blank.

The scenarios in Chapter 2 provide display examples.

## Do Not Disturb

---

Calls transferred to non-local extensions with Do Not Disturb active do not return and the caller may hear busy. The exception is a transfer to an extension with Do Not Disturb active that is routed over a PRI tandem trunk and manually completed is returned as an incomplete transfer.

In Release 6.1 and later systems, transfers to non-local extensions with Do Not Disturb active by system operators using a DSS programmed for transfer with automatic completion will not return if the transfer is automatically completed. DSS button LEDs for non-local extensions do not reflect busy or Do Not Disturb status and Inspect does not show that a non-local extension has Do Not Disturb active.

## Extended Station Status

---

For Release 6.0 and later systems, this feature does not apply to non-local UDP calls.



## Forward and Follow Me

---

The use of Forward and Follow Me in networked systems is as follows:

- For Release 6.0 and later systems, Follow Me is not supported across the private network.
- For Release 6.1 and later systems, Call Forwarding is used to forward calls directly to a non-local extension; you do not have to enable Remote Call Forwarding. When programming call forwarding to a non-local extension, add # at the end of a number.
- For Release 6.0 systems, Remote Call Forwarding can be used in combination with Caller ID on a loop-start PSTN line connected to an 800 LS-ID line/trunk module. The LS-ID Delay option must be programmed to On for each line connected to the 800 LS-ID module. To pass Caller ID information across the private network when a call is transferred, set the Remote Call Forwarding Delay to one ring. Transfer of the call must be completed before the call is forwarded.

The user at the extension that first receives the Caller ID call from the PSTN turns Remote Call Forwarding on and specifies forwarding across the private network, over PRI tandem trunks only, to a non-local extension with an MLX display telephone.

Redirected transfer calls do not forward across the network.

## Group Calling

---

Private networked trunks cannot be programmed to ring into calling groups, because tandem trunks are dial-in facilities.

When calling group extensions are included in the non-local dial plan, calls to non-local calling groups are made just as calls to other non-local dial plan extensions are, using the calling groups' extensions. Calls can be transferred to non-local calling groups. If the transfer is completed while listening to a Delay Announcement message, the announcement will not play again.

For Release 6.0, all members of a calling group must be connected to the same local system.

In Release 6.1 and later, a calling group may have a *single* non-local member that is defined under the Uniform Dial Plan as existing on another MERLIN LEGEND Communications System connected by a tandem trunk. A calling group can have a single non-local member or several local extensions. The same calling group *cannot* have both local members and a non-local member.

In Release 6.1 and later systems, a calling group containing a single non-local member can be used for most of the same purposes as a calling group containing only local extensions. This includes:

- **Night Service** coverage across a private network to a centralized Automated Attendant, non-local calling group, QCC queue, DLC, or any individual extension such as a night bell or an extension on a remote MERLIN LEGEND, DEFINITY ECS or DEFINITY ProLogix system, or to the PSTN via UDP routing.
- **Group Coverage** across a private network to a centralized VMS/AA, non-local calling group, QCC queue, DLC, or any individual extension on a remote MERLIN LEGEND, DEFINITY ECS or DEFINITY ProLogix system, or to the PSTN via UDP routing.
- **Calling group overflow coverage** to a centralized VMS/AA, non-local calling group, QCC queue, DLC, or any individual extension within a remote MERLIN LEGEND, DEFINITY ECS or DEFINITY ProLogix system, or to the PSTN via UDP routing.



**NOTE:**

Be sure that overflow coverage does not go back and forth between systems because facilities will be tied up. Each leg of the call ties up a tandem trunk because release link is not provided. For example: System A calling group overflows to System B calling group and System B calling group overflows to system A calling group. In this case, if both are busy, the calls bounce back and forth tying up facilities along the way until an agent becomes available on one of the calling groups or all trunks are busy.

- **QCC Position Busy Backup coverage** to a centralized VMS/AA, remote calling group, QCC queue, DLC, or any individual extension within a remote MERLIN LEGEND, DEFINITY ECS or DEFINITY ProLogix system, or to the PSTN via UDP routing.



**NOTE:**

VMS transfer returns are delivered only to the first QCC and will not be sent to the QCC Position Busy Backup destination.

The following considerations apply when using a calling group with a non-local member:

- If the pattern associated with the calling group has a route that includes PSTN trunks, each call over the PSTN has an associated cost.
- SMDR records for calls sent across a private network may be different from what is expected. For example, UDP calling may not be logged for part of the call. If a call from system A is routed through system B to system C and system A has SMDR turned on to log UDP calls, system B has SMDR turned off to log UDP calls and system C has SMDR turned on to log UDP calls, the call is logged at system A, not at system B and logged at system C.

3 Feature Interactions

Hands Free Answer on Intercom (HFAI)

- Calls sent to a calling group with a non-local member will never overflow locally. The calls are sent across the private network and the exact processing depends on the nature of the receiving extension on the far system. As a result, local delay announcement devices, queue alarm, external alert, and queue control will never be activated for a calling group with a non-local member.
- An extension on a MERLIN LEGEND system cannot be a member of a DEFINITY ECS or DEFINITY ProLogix hunt group.



**NOTE:**

The DEFINITY ECS “route to” step in vectoring can overflow calls to a non-local extension on a MERLIN LEGEND. However, no Look Ahead Interflow is provided and calls are recorded in BCMS and CSM as an “Outflow” call. For complete details, refer to DEFINITY ECS documentation.

- More than one calling group with a non-local member can be assigned on a system.
- A calling group with a non-local member cannot have a local member and a calling group with local members cannot have a non-local member.
- A non-local number can be a member of more than one calling group.
- When coverage calls using calling groups are routed across a private network, an MLX display telephone shows information about the call origination. It does not indicate that the call is a coverage call as would be the case for local coverage. Personnel who may receive coverage calls for non-local extensions should be advised of this difference in displayed information between local and non-local coverage. The exact information displayed depends on whether the tandem trunk connecting the systems is a PRI trunk or a tie trunk as shown below.

**Table 3–1. Cross-Network Display Information**

Tandem Type	Inside Calls	Outside Calls
PRI	Caller’s Name	Caller ID/ANI (as long as not answered)
Tie	Trunk Number	Trunk Number

## Hands Free Answer on Intercom (HFAI)

Hands Free Answer on Intercom (HFAI) button does not work for calls from non-local dial plan extensions. These calls are treated as outside calls.

## HotLine

---

A HotLine extension must be on the local system. However, a HotLine telephone can dial a non-local extension number.

## Labeling

---

For incoming calls, the alphanumeric label and/or extension number for non-local dial plan extensions appears on local system MLX displays according to display preference programming. This feature works only when PRI tandem trunks convey the calls.

When operators make intersystem calls, you should relabel the default OPERATR label to distinguish operators in different systems.

The system supports the display of DEFINITY ECS or DEFINITY ProLogix Solutions extension labels, although long DEFINITY ECS or DEFINITY ProLogix Solutions labels may be truncated on MERLIN LEGEND Communications System MLX displays, which support a maximum of 7 characters for name labels and 7 characters for extension number labels.

## Messaging

---

Leave Word Calling only works only if the calling extension, called extension, and covering voice mail for the called extension are on the same system. For 6.1 and later systems, when a centralized VMS is located on a remote system from the calling extension and called extension, incorrect confirmation messages and no error tones may indicate that Leave Word Calling succeeded but no message is sent to the called extension.

An operator cannot turn a message light at a non-local extension off or on and cannot inspect the message status of a non-local extension. Send/Remove Message is not supported for non-local dial plan extensions.

Posted Messages do not appear at the display telephones of non-local extensions.

Fax message-waiting is not supported for non-local extensions.

For MLX display telephones, the Return Call option from the Messages menu cannot be used to return calls to non-local extensions.

## Music On Hold

---

Music On Hold sources cannot be shared by networked systems.

Calls between systems in a private network are treated as outside calls; for this reason, non-local callers hear Music On Hold as though they were outside callers.

## Night Service

---

All Night Service group extensions and lines must be on the local switch as must be any Night Service alerts.

For Release 6.1 and later systems, Night Service calls can receive coverage by a calling group with a non-local member that routes calls to a centralized VMS/AA, to a non-local calling group, to a non-local extension, or to a non-local QCC. When Night Service calls are directed to a remote system, the Night Service status of the receiving system determines call handling. If the receiving system is in a different time zone, has different holidays, or has different hours of operation, the results of routing calls to non-local calling groups or QCCs may be different than expected. The automated attendant greetings should be programmed appropriately.

If Night Service is programmed with outward restriction, the restriction does not apply to non-local dial plan calls. Exclusion lists apply only to the local system's extensions and do not apply to UDP calls.

During Night Service operation, a user can call into a shared remote access trunk and use remote access to reach non-local extensions.

During Night Service operation, an intersystem call to a member of a Night Service group rings at all member extensions.

Transitions into and out of Night Service must be made locally. For example, an operator cannot turn on Night Service at a remote system.

Private trunks should not be assigned to a Night Service group.

Calls to members of a Night Service group will not forward across the private network.

## Paging

---

Loudspeaker and voice paging calls cannot be made to non-local dial plan extensions or paging groups.

## Park

---

Park zones must be in the local system. Calls cannot be parked at remote park zones.

## Personal Lines

---

To avoid toll fraud, private networked trunks must not be assigned to extensions as personal lines.

In Release 6.1 and later systems, only the principal user of a personal line can forward calls received on the personal line to a non-local extension.

## Pickup

---

Calls at non-local extensions cannot be picked up in the local system.

## Pools

---

All private trunks must be assigned to pools of trunks that are of the same type (PRI, analog tie, T1-emulated tie programmed for voice, or data). For security reasons, dial access and **Pool** button access to these pools must not be permitted.

You cannot assign local PSTN lines/trunks as personal lines on non-local extensions.

**Pool Status** buttons show the busy or not-busy status of private trunk pools as well as outside trunk pools on the local system only.

Where PRI tandem trunks are available, their pools should be assigned as Route 1 for the purpose of UDP routing.

## Primary Rate Interface (PRI) and T1

---

[“Tandem Trunks” on page 10](#) and the scenarios in Chapter 2 provide details about private network routing of incoming outside calls received on PRI and T1 facilities. Programming is described in Chapter 5, [“Network Management.”](#)

PRI or T1 facilities can be private tandem trunks. Customers order a point-to-point T1 circuit from a service provider, then use system programming to set it up for tandem PRI services. It can also be set up for T1-emulated tie service for voice communications and for data communications (channels must be programmed for voice or data and are not dynamically allocated). The system also supports fractional T1 services, allowing you to subscribe to just the number of channels (from 1 to 23) that are required for T1 voice and/or data. ANI and extension number/alphanumeric label display are supported on tandem PRI facilities but not on tandem T1 facilities.

As necessary, a service provider can provide amplification for these tandem trunks, but does not supply switching services. Tandem PRI facilities provide data communications at 64 kbps per B-channel (128 kbps for 2B data), while tandem T1-emulated tie facilities provide data communications at 56 kbps per channel (112 kbps for 2B data).

Drop-and-insert equipment can be placed between a system and the CO that is providing the T1 circuit. This allows use of T1 channels for dedicated non-MERLIN LEGEND/video communications between sites, while keeping the remaining T1 channels for MERLIN LEGEND traffic. The 24th T1 channel must not be dropped.

When system programming of the Digital Signal 1 (DS1) switch type as MERLIN LEGEND-PBX or MERLIN LEGEND-Ntwk identifies a PRI facility as a tandem trunk, the system selects an unused B-channel group, starting with Group 80 and counting backward, and assigns all the B-channels to that group. This programming can be changed after the initial assignment. All the available B-channels (a maximum of 23) are added to the automatically selected B-channel group, and any dropped B-channels must be manually deleted from the group. The D-channel must not be dropped. All 23 B-channels must still be programmed (as unequipped if not used) and all 24 channels, including the D-channel, count towards the system maximum of 80 lines/trunks.

PRI and T1 tandem trunks require the same initial DS1 programming (clock synchronization, framing format, and so on) that other PRI facilities do. However, routing, network service, and copy telephone number settings are programmed automatically by the system and cannot be changed unless the switch type is modified first. For details, see Chapter 5, “Network Management,” and *System Programming*.

## Queued Call Console (QCC)

---

For Release 6.0 systems, an extension may not have its calls covered by a QCC on another system.

For Release 6.1 and later systems, overflow coverage for calling groups or Night Service coverage to a non-local QCC queue can be accomplished by creating a local calling group with a single non-local member as the overflow coverage receiver for the calling group.

The non-local extension number assigned to the calling group is the extension assigned to the QCC queue at the receiving system and must be programmed within a range in the sending system's non-local dial plan.

In Release 6.1 and later systems, a calling group with a non-local member can be used as a QCC position busy backup. This allows calls to be routed across the private network to a non-local QCC queue, a non-local calling group, or to an individual non-local extension.

For Release 6.0 and later systems, a QCC operator can manually extend a non-local dial plan extension call to a local extension, a non-local dial plan extension, or a destination outside the private network. In Release 6.1 and later systems, the QCC operator can use the DSS to place or transfer calls to non-local extensions. The DSS can be used to manually or automatically extend calls to non-local extensions.

If the QCC operator manually extends a call to a busy or invalid non-local extension, the manual transfer can be returned only if the manual transfer took place over tandem PRI trunks. If the transfer took place over tandem tie trunks or the transfer was automatically completed over PRI tandem trunks, it is not returned in the event that the destination is busy or invalid.

A QCC **Pool Status** button shows activity on private network trunk pools as well as other trunk pools on the local system.

A call from a non-local dial plan extension over tandem trunks can be prioritized as an LDN or Dial 0 call to the QCC. A call from the QCC to a non-local dial plan extension is treated as an outside call for the purpose of the Conference Join function.

## Reminder Service

---

Reminder Service does not function across a private network.



## Remote Access

---

[“Remote Access” on page 8](#) provides details about setting up and using remote access in private networks. The scenarios in Chapter 2 provide examples of remote access setup and use in private networks. In addition, Chapter 4, “Security,” provides information about how remote access is used in private networks.

Remote access allows tandem and UDP calls and non-local private network ARS users to call out on local trunks connected to the PSTN, permitting cost savings. Default COR permissions and restrictions must be assigned to all tie or all non-tie trunks, depending on whether private network trunks are tie trunks (analog, T1-emulated tie) or non-tie (PRI) facilities. Toll and outward restrictions should be removed from the COR for these facilities. When a tandem UDP or ARS call is routed across the private network on tandem trunks, the local COR FRL at the receiving system is compared to the FRL for the local ARS or UDP route. For the call to go through, the default COR FRL must be equal to or greater than the route FRL. UDP and ARS at a remote system can route calls to yet another system on the private network.

A Remote Access code can be programmed into the non-local dial plan to allow toll savings for remote access calls across the private network. Barrier codes and associated barrier code Disallowed Lists and FRLs should be applied.

A caller can also reach remote access on a networked system by calling in on DID or dial-plan routed trunks or by calling in on a line/trunk programmed for shared or dedicated remote access. During Night Service operation, a user can call into a trunk programmed for shared remote access and use remote access to reach non-local extensions. As in non-network operation, the local system applies any required restrictions. Barrier codes and other remote access restrictions should be assigned for this type of calling.



### SECURITY ALERT:

*Networked systems require special attention to security issues. Follow the rules below when setting up and planning your system for private network use.*

- *Ensure that barrier codes are required for incoming remote access calls received on PSTN dial-plan routed and tandem facilities that route to the Remote Access code (889, for example). When you program the default COR, turn the barrier code requirement on. This setting is ignored for ARS calls and calls to non-local extensions across the private network. However, it is still applied to DID and PRI dial-plan routed remote access calls as well as to calls received on a tandem trunk and routed to a Remote Access code. Because the COR Calling Restriction must be set to unrestricted for private network calling, using barrier codes on these facilities is essential in order to apply security measures. When a Remote Access code is included in the non-local dial plan of the calling system, the caller's barrier code FRL on the called system is compared to the UDP or ARS route FRL on the called system. See the Feature Reference and ["Remote Access Default Class-of-Restriction Settings" on page 6](#) for details.*
- *Extension and ARS FRLs should be carefully and stringently assigned in order to prevent unauthorized trunk-to-trunk transfers to local PSTN facilities. [Table 4-1, page 4-3](#) explains the operation of this feature in a networked system.*

A remote access caller can call a number in the non-local dial plan.

## Service Observing

---

Service Observing cannot be used across networked switches. All members of the Service Observing group including the observer must be on the same MERLIN LEGEND system.

## Signal/Notify

---

These features do not function across a private network.

## Station Message Detail Recording (SMDR)

---

For 6.0 systems, all private network calls are reported according to SMDR Call Report programming for reporting non-UDP incoming and outgoing calls. To log network calls, SMDR should be programmed to report both incoming and outgoing calls.

In Release 6.1 and later systems, SMDR can be programmed to record incoming/outgoing UDP calls or no UDP calls. When a system is programmed to record no UDP calls, only calls received on a PSTN trunk and/or routed over the private network to a PSTN trunk on a remote system using ARS or DID/PRI dial plan routing are included on SMDR reports. The default value programming is to record incoming UDP calls. This programming is local to each system, and is not network wide.

For Release 6.0 and later systems, calls across the network are not recorded, even at a tandem switch, if the call is not answered unless the outgoing facility is a loop-start or ground-start trunk. Then calls are logged, even unanswered calls.

Ensure that the system date and time are set accurately on each system that carries private network calls. If the system date and time are not synchronized across the network, it may be hard to recognize the records for a single call, even when the systems are in the same time zone. When reviewing reports, consider When UDP calls are recorded on SMDR reports, a single call routed across a private network, is recorded as both an incoming and an outgoing call in the same system. For network calls, outgoing call records report the incoming tandem trunk number in the STN. field (see System B in Figure 3-1 below). Dialed digits shown on the report do not reflect any digit manipulation (addition or absorption) performed by the local system. Uncompleted calls do not generate a SMDR report, except for calls over loop-start or ground-start trunks, which generate SMDR reports whether completed or not. SMDR reports may report calls using more than one call record on more than one system. Depending upon how SMDR is programmed and how calls are routed, you may need to consult several SMDR records to trace a call that is routed over network trunks.

[Figure 3-1](#) shows examples of different call types and how they are recorded on SMDR reports when the SMDR call report option is set to log incoming and outgoing calls and for Release 6.1 and later systems, the SMDR UDP option is set to log all UDP calls at each systems in the private network.

**Incoming DID call from the PSTN routed across the private network.**

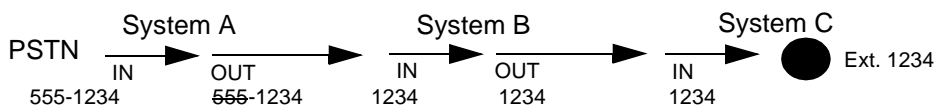

**Outgoing ARS call routed across the private network and out to the PSTN using a remote system's PSTN facilities.**

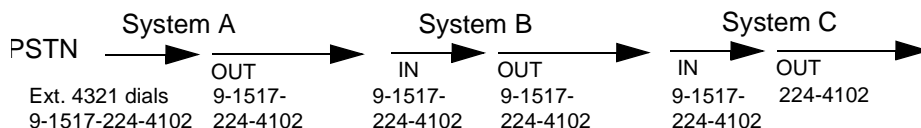

**Extension to non-local extension.**

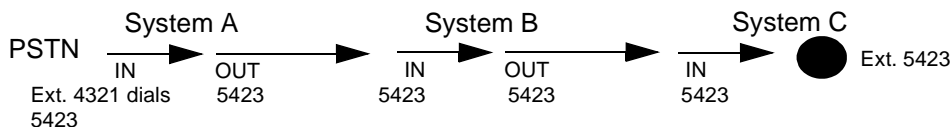

**Figure 3-1. UDP Calls Recorded at All Systems**

For Release 6.1 and later systems, [Figure 3-2](#) shows examples of different call types and how they are recorded on SMDR reports when the SMDR call report option is set to log incoming and outgoing calls and for Release 6.1 and later systems, the SMDR UDP option is set to log no UDP calls at each system in the private network. An "X" over the incoming or outgoing portion of the call indicates that the portion of the call is not recorded on the SMDR report.

**Incoming DID call from the PSTN routed across the private network.**

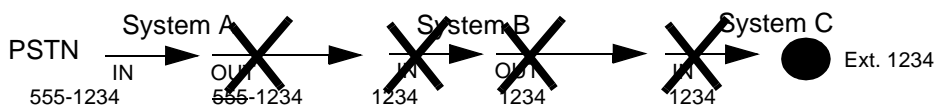

**Outgoing ARS call routed across the private network and out to the PSTN using a remote system's PSTN facilities.**

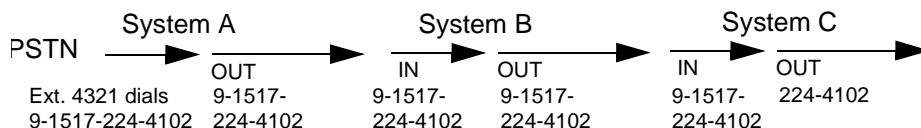

**Extension to non-local extension.**

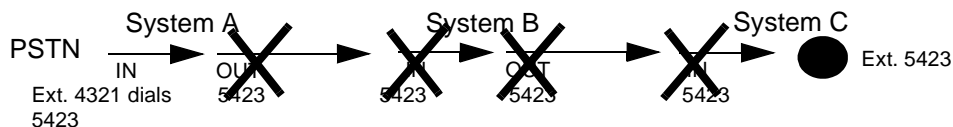

Figure 3-2. No UDP Calls Recorded at All Systems

## Speed Dial

Non-local dial plan numbers can be programmed as speed dial numbers.

System speed dial numbers can only be accessed by local system users.

## System Renumbering

---

A separate numbering plan is provided for non-local dial plan extensions, allowing system managers to enter the ranges of extensions on remote systems. These ranges are associated with patterns that in turn allow routing over private tandem trunks or over PSTN facilities when appropriate. These ranges must be unique and unambiguous in the local dial plan. Programming remote extension ranges does not affect the remote system or the extension numbering used within the remote system. When a system is renumbered to the factory-set default, non-local dial plan extension ranges are deleted.



### NOTE:

Non-local dial plan programming can be used to route an extension's calls to an outside number. This may be convenient when, for example, an extension user is working at home and wants to receive calls at a home telephone number.

## Transfer

---

Transfers of outside or non-local dial plan calls to non-local dial plan extensions are actually trunk-to-trunk transfers. Most extensions, including those equipped with single-line telephones, can make these calls, regardless of system programming for trunk-to-trunk transfer. The incoming call must be on a trunk with reliable disconnect. If a private network trunk is not available to carry the transferring call, the consultation call can be callback-queued on the first route, but the transfer must still be in progress.

If the system manager has prohibited an extension from making trunk-to-trunk transfers, it is still prevented from transferring inside or outside calls to another local system trunk connected to the PSTN. However, despite prohibitions, the following types of calls are allowed:

- A call on a private network trunk transferred to a non-local dial plan extension
- A call on an outside central office line/trunk (except on a loop-start line without reliable disconnect) transferred to a non-local dial plan extension
- A call on a private network trunk transferred to an outside central office line/trunk

A call transferred over a tandem PRI trunk to a non-local dial plan extension with an MLX display telephone does not receive the same call information that an inside transfer does. Only the extension number and label (if programmed) of the transferring extension are shown. However, most transfer functions operate normally between local and non-local dial plan extensions. Except when transfers are sent by or received by PassageWay Telephony Services clients with a CTI link. Users at these extensions must make manual transfers by using the telephones at their extensions.

Transfers across networked systems over tandem tie trunks do not return to the transferring extension. If such a call is transferred to a busy or invalid non-local dial plan extension or one with Do Not Disturb turned on, the transferred party hears busy or fast busy tone and must hang up and call back in order to speak with someone. If a transfer is made across a private network over tandem PRI trunks only, it returns to the transfer originator in the event that the intended destination is busy, invalid, or has turned on Do Not Disturb.

For Release 6. and later systems, when a centralized automated attendant transfers a call to a non-local extension, the transferring system monitors the call to ensure that it is answered. If the non-local extension is not available or the call is not answered within the fixed redirect interval (32 seconds), the call stops ringing at the remote destination and is redirected to an extension on the transferring system (the system with the centralized VMS/AA) that is programmed to receive redirected calls. This extension can be the first QCC queue, another extension, or a calling group (the call is directed to an available member and not sent to calling group coverage).



**NOTE:**

Calls transferred by the VMS/AA to a calling group with a non-local member, and all UDP routes are busy, will go to the redirect destination upon transfer completion. If a transferred call travels over a loop-start or ground-start line to the PSTN, it will not return for redirection.

## Voice Announce to Busy

---

Voice-announced calls arrive at non-local dial plan extensions as ringing calls and not as voice calls.

## Voice Messaging Interface (VMI)

---

In Release 6.0, each system in a private network must have its own voice mail application. However, an automated attendant application can route calls to a non-local dial plan extension (requires Release 6.0, Version 11). A single system must include both the application and all PSTN trunks that call into the application. Also, some VMS applications transfer calls only to extensions with a predefined number of digits (for example, to 4-digit extensions only).

Private trunks must be numbered uniquely and without ambiguity across the private network; 4-digit line/trunk numbers are recommended for this configuration. To avoid ambiguity, trunks should not be numbered as, for example, 890 and 8900.

For Release 6.1 and later, group coverage and calling group overflow calls can be routed from one MERLIN LEGEND Communications System to another MERLIN LEGEND Communications System over tandem PRI or tie trunks providing that the two systems are directly connected by the tandem trunks.

**3** Feature Interactions

*Voice Messaging Interface (VMI)*

*Page 3-28*

All remote systems in the private network can have Group Coverage for individual extensions or overflow coverage for calling groups directed to the centralized VMS/AA by creating a local integrated VMI calling group with a single non-local member (called the VMI conversion number). The local integrated VMI calling group is then programmed as the receiver for Group Coverage calls and/or as the calling group overflow receiver.

For additional information see Centralized Voice Mail in this chapter.



## Security

# 4

---

This chapter describes the security issues that you must consider as you plan and maintain a system in a private network. Most of these points have been raised in earlier chapters, and Chapter 2, “Call-Handling Scenarios,” provides examples of security considerations. This chapter consolidates the information in order to make security planning and implementation easier for system managers.

In a network of two systems, the system managers must work together to agree upon security measures and how they are implemented. In a larger network, system managers cooperate in the same way. Once they have agreed upon security plans, a coordinating system manager for the network should clear all modifications to the original security plan.

After an introductory overview that summarizes security design for networked systems and covers a variety of system features, this chapter explains Facility Restriction Levels (FRLs) as they are used by various features such as Automatic Route Selection (ARS), Remote Access, and Uniform Dial Plan (UDP) routing.



**NOTE:**

This chapter discusses only those aspects of system features and system programming that affect security. Detailed information about features and programming is included in the *Feature Reference* and in *System Programming*. In this book, Chapter 5, “Network Management,” highlights programming for networks. Chapter 3, “Feature Interactions,” describes how system features work in private networks. General information about security is included in Appendix A, “Customer Support Information.” Information about security for specific voice messaging systems for non-local users using centralized VMS/AA is included in Appendix C, “Voice Messaging Systems.” You should review these appendices carefully.

## Overview

---

Security planning and implementation, like other aspects of networking, require careful coordination among system managers. Local system business needs must be balanced with overall routing and security considerations. Network system managers must combine existing features and new networking features to safeguard against toll fraud. At the same time, security features must be fine-tuned to enable efficient calling across the network.

As discussed in earlier chapters, ARS and Remote Access features are used in combination to allow users to access PSTN trunks connected to other systems in the network. Such ARS calls are made normally, just as they are in non-networked systems. System programming of ARS tables, routes for tandem trunks, and remote access default class-of-restriction (COR) ensures correct and secure call routing. For the purposes of security, Facility Restriction Levels (FRLs) are the most important components of these features. The next topic in this chapter discusses how different types of FRLs—ARS, remote access default COR, and extension—interact in a private network.



### NOTE:

The ARS access code of a networked system should never be assigned to the non-local dial plan. This might allow network users to inadvertently or purposefully access PSTN facilities connected to a network system. The local system ARS access code *cannot* be programmed into the non-local dial plan; if all ARS access codes in a network match, this safeguard is more effective. For this reason and for convenience and proper call-routing in some situations, **it is recommended that all the systems in a network use the same ARS access code.**

To enable calling among users on a network, certain calling restrictions are suspended when people on one system call extensions on another system, while others remain in effect. In addition, private network trunks and pools of private network trunks must be safeguarded and treated differently than PSTN trunks in order to avoid toll fraud through access to other networked systems. [Table 4-1](#) summarizes these operations. The *Suspended* column relates to restrictions only and indicates whether or not the restriction is applied to calls made to non-local extensions.

[“Facility Restriction Levels and Remote Access” on page 5](#) discusses security considerations that require more detailed information.

**Table 4-1. Calling Restrictions and Security Feature Planning in Networks**

Restriction, Feature, or Setting	Factory Setting	Suspended?	Description
Personal Lines	Not Applicable	Not Applicable	Private network trunks must never be assigned as personal lines or extensions.
<b>Pool</b> buttons	Not Applicable	Not Applicable	Users (including DSS users) must never be given <b>Pool</b> button access to pools of tandem trunks.
Dial Access to Pools	Not Allowed	No	Users must never be given dial access to pools of tandem trunks.
Trunk-to-Trunk Transfer	Not Allowed	Yes	<p>An extension that is prohibited from making trunk-to-trunk transfers cannot transfer an outside call to another local system trunk connected to the PSTN that is a PSTN trunk-to-trunk transfer. However, despite prohibitions, a user can transfer a private network trunk call to a non-local extension or to an outside central office trunk. A restricted user can also transfer an outside call to a local or non-local extension but not to an outside PSTN trunk.</p> <p>Note that if an extension receives an outside call transferred from a non-local extension from a non-local extension over a tandem trunk, the user can then transfer this outside call to an outside PSTN facility using the private network or the PSTN, if assigned to a UDP route. In this case the user has performed a PSTN trunk-to-PSTN trunk transfer and possibly bypassed intended restrictions. In this scenario, a HIGH FRL appropriate for the route, should be considered.</p>
Outward Restriction: Extensions	On	Yes	Despite outward restrictions, users can make calls to non-local extensions. For Release 6.1 and later, calls can be routed to centralized VMA/AA.
Outward/Toll Restriction: Remote Access	On	No	In order to route ARS and UDP calls across the network, this setting should be changed to unrestricted, as applied to the default COR for all tie and/or all non-tie tandem facilities. See <a href="#">"Remote Access Default Class-of-Restriction Settings" on page 6</a> .

*Continued on next page*

<b>Restriction, Feature, or Setting</b>	<b>Factory Setting</b>	<b>Suspended?</b>	<b>Description</b>
Toll Restriction	On	Yes	Despite toll restrictions, users can make calls to non-local extensions.
Allowed and Disallowed Lists	Disallowed List 7	No	Retain Disallowed List 7 and add to it as necessary. Non-local extension numbers can be added to the Disallowed Lists to prevent a user from calling a non-local extension. Apply Disallowed Lists only, not Allowed Lists, to remote access barrier codes and to the default class -of-restriction for all tie and/or all non-tie tandem facilities.
Night Service with Outward Restriction	Off	Yes	Regardless of Night Service restrictions, a user can make calls to non-local extensions.
Extension Status	Off	Yes	Regardless of Extension Status, a user can make calls to non-local extensions.



### SECURITY ALERT:

*Networked systems require special attention to security issues. Follow the rules below when setting up and planning your system for network use.*

- *Ensure that barrier codes are required for incoming remote access calls received on PSTN dial-plan routed facilities and tandem facilities that route to the local system by dialing the Remote Access code (889, for example). When you program the default COR, turn the barrier code requirement on. This setting is ignored for ARS calls and calls to non-local extensions across the network. However, it is still applied to DID and PRI dial-plan routed remote access calls as well as to calls received on a tandem trunk and routed to a Remote Access code. Because the COR Calling Restriction must be set to unrestricted for network calling, using barrier codes on these facilities is essential in order to apply security measures. When a Remote Access code is included in the non-local dial plan of the calling system, the caller must enter a barrier code and that barrier code FRL on the called system is compared to the UDP or ARS route FRL on the called system. See the Feature Reference and [“Remote Access Default Class-of-Restriction Settings” on page 6](#) for details.*
- *Extension and ARS FRLs should be carefully and stringently assigned in order to prevent unauthorized trunk-to-trunk transfers to local PSTN facilities. [Table 4–1, page 4-3](#) explains the operation of this feature in a networked system.*

## Facility Restriction Levels and Remote Access

---

Facility Restrictions Levels (FRLs) are number values from 0 to 6 that are used to allow or disallow calling. FRLs apply to the following four aspects of systems in a network:

- **Automatic Route Selection Routes.** ARS routes are assigned to subpatterns that the system selects according to the time of day. Each route is assigned an FRL. An FRL of 6 is the most restrictive, and an FRL of 0 is the least restrictive. Factory-set ARS route FRLs are as follows:
  - Routes assigned to Default Toll Tables: 3
  - Routes assigned to the Default Local Table: 2
  - Routes assigned to pools: 3
- **Uniform Dial Plan Routes.** UDP routes are associated with patterns that also specify digit manipulation for directing calls to non-local extensions over tandem facilities, or directing calls to non-local PSTN facilities. Like ARS routes, UDP routes are assigned FRLs. The factory setting for UDP routes is 3.

- **Extensions.** The factory-set FRL for extensions is 3. When an extension user attempts to use ARS or make a UDP call on his or her local system, the extension FRL is compared to the local ARS or UDP route FRL. In order for the call to go through, the extension FRL must be equal to or greater than the route FRL.
- **VMI Ports.** The factory-set FRL for VMI ports is 0.
- **Remote Access Default Class-of-Restriction.** The factory-set FRL for Remote Access is 3. To allow routing of calls through a system in a network, the local system manager assigns an FRL and other restrictions to a class of trunks, using remote access programming. This operation is described in the next topic.

## Remote Access Default Class-of-Restriction Settings

---

All remote access COR settings are applied in networked systems for the following calls:

- UDP and ARS calls that arrive on tandem trunks from another networked system and are routed to another system or to the PSTN.
- Remote access calls that arrive at a local system on a public-switched network DID trunk or PRI dial-plan routed facility.
- Remote access calls that are made by entering a Remote Access code that has been included in the non-local dial plan of the calling system.
- In Release 6.1 and later systems, calls that arrive on lines assigned to a calling group with a non-local member that are routed to a remote system.

The Remote Access COR settings must be planned and implemented carefully to permit ARS and UDP extension calls across the network as appropriate, while prohibiting remote access calling that might violate an organization's security needs.



### NOTE:

When remote access is explicitly assigned to a loop-start or ground-start trunk or to a PRI facility routed by line appearance, that line/trunk is assigned to remote access, and default COR settings do not apply if barrier codes are required. The remote access user calls into the system on this type of facility and enters the barrier code, if required, just as they do in non-networked systems. The *Feature Reference* describes this operation.



### SECURITY ALERT:

If barrier codes are **not** required, these calls receive default COR for non-tie trunks. If the system uses tandem PRI trunks for ARS to route calls through the system, then the calling restriction option of the default COR must be set to unrestricted. This can lead to toll fraud.

## 4 Security

### Facility Restriction Levels and Remote Access

Page 4-7

The system manager sets the options listed below for the remote access default COR on his or her own system. If the system is linked to the network by tandem tie facilities (analog, T1-emulated voice, or data), the settings are assigned to all tie trunks. If only tandem PRI trunks link the system to the network, the settings are assigned to all non-tie trunks. If both tandem tie and tandem PRI trunks are connected to a system, the default COR FRLs and other restrictions are assigned to their restrictive types of trunks.

- **Barrier Code Requirement.** In a network, this setting should be turned on in order to require barrier code entry on calls that arrive from the PSTN over DID or PRI dial-plan routed facilities or that are made by dialing a Remote Access code included in the non-local dial plan. When barrier codes are not required, the remaining default COR settings apply to PSTN calls as well as network calls. This poses a security risk and does not allow adequate protection against toll fraud. The barrier code requirement is ignored for calls on tandem trunks, but the remaining default COR setting does apply to such calls.

When barrier codes are required, the following restrictions can be assigned to individual barrier codes used on remote access calls that arrive on PSTN lines/trunks or that are made by dialing a Remote Access code included in the non-local dial plan:

- **Restriction.** Determines whether remote access users can make local and/or toll calls, and includes the following settings: Unrestricted, Toll-restricted, and Outward-restricted.
- **ARS FRL.** Allows or restricts use of outgoing trunks by assigning an FRL. The FRL ranges from 0 (most restrictive) to 6 (least restrictive).
- **Allowed/Disallowed Lists Assignment.** Disallowed Lists can be assigned. The factory setting is 3. Do not assign any Allowed Lists.
- **Calling Restrictions.** This setting determines whether local and/or toll calls are allowed. The factory setting is outward- and toll-restricted. To allow call routing to the PSTN or to another system in the network, this setting should be changed to unrestricted, allowing the routing of all such calls.
- **Facility Restriction Level.** Use this FRL setting by assigning a restriction level from 0 to 6, 0 is the most restrictive, and 6 is the least restrictive. The FRL value assigned here is the opposite of the FRL value assigned to an ARS route, where a value of 0 is the least restrictive, and a value of 6 is the most restrictive. The factory setting is 3. To restrict calls from using selected UDP or ARS routes, assign a value that is lower than the FRL assigned to the route. Network call routes (UDP or ARS) use this default COR FRL and do not use barrier codes. As long as you require barrier codes for the default COR setting, the barrier code FRL and not the default COR FRL, is applied to remote access calls that arrive on PSTN dial-plan routed PRI facilities or on DID trunks or that are made by dialing a Remote Access code included in the non-local dial plan.
- **Allowed List Assignment.** Do not assign any Allowed Lists.

- **Disallowed List Assignment.** Disallowed Lists should be used for the default COR. You should use Disallowed List 7, which prohibits a variety of calls often made by toll fraud abusers. Review and add to this list as needed. When a Disallowed List is assigned, ARS calls cannot reach the specific numbers included on the list. When barrier codes are required for the default COR, Disallowed Lists should be assigned to individual barrier codes.

Automatic Callback can be turned on or off for remote access calls. However, the remote access Automatic Callback setting does not apply to network calls that have been routed to another system using ARS or UDP routing. Callback features only work for lines and trunks on a local system. [“Callback” on page 4](#) provides additional information.

[Table 4–2](#) includes a summary of the options discussed above, along with recommended settings for network routing. You may need to set these options differently, according to your organization’s needs and the requirements of your own network.



**Table 4–2. Recommended Settings for Tie and Non-Tie Default COR and Callback**

Setting Name	Recommended Setting	Description
Barrier Code Requirement	On	Requires barrier code entry for remote access calls on DID, PRI dial plan-routed, dedicated or shared remote access, or tandem facilities. Remote access calls will arrive over tandem trunks if the Remote Access code is included in the non-local dial plan of the calling system. Ignored for UDP calls across the network.
Calling restrictions	Unrestricted	Allows routing across the network. Toll restrictions can still be applied to remote access calls on DID or PRI dial plan-routed facilities, as long as barrier codes are required.
Facility Restriction Level	Higher than 1	For a call to be routed to the PSTN or to an extension on another system in the network, the FRL assigned here must be equal to or greater than the UDP or ARS route FRL.
Allowed List	None	Not Applicable
Disallowed List	Disallowed List 7	Prohibits calls to the numbers in the list. Modify as needed. Other lists can be assigned to barrier codes and default CORs.
Automatic Callback	No recommendation	Applies to all remote access calls that arrive on PSTN trunks but does not apply to UDP- and ARS-routed network calls. For extensions making intersystem or ARS calls, Callback can be turned on or off at the extension.

### How Facility Restrictions Levels Work in a Network

The diagram in [Figure 4–1](#) illustrates how FRLs function in a network. An extension's FRL is compared to the local ARS route FRL or the local dial plan route FRL, whichever is used for the call. If the extension user has dialed a Remote Access code included in the non-local dial plan, the user's barrier code FRL is compared to the UDP or ARS route FRL before the call leaves the calling system (barrier codes must be required in the default COR setting on the called system for the applicable type or types of tandem facilities). If the extension or barrier code FRL is equal to or greater than the route FRL, the call goes through.

4 Security

Facility Restriction Levels and Remote Access

After a call is routed to another system, the extension/barrier code FRL has no effect. The remote system's default COR FRL takes its place. For the call to go through, the default COR FRL must be equal to or higher than the remote system ARS or UDP route FRL, whichever is routing the call next.

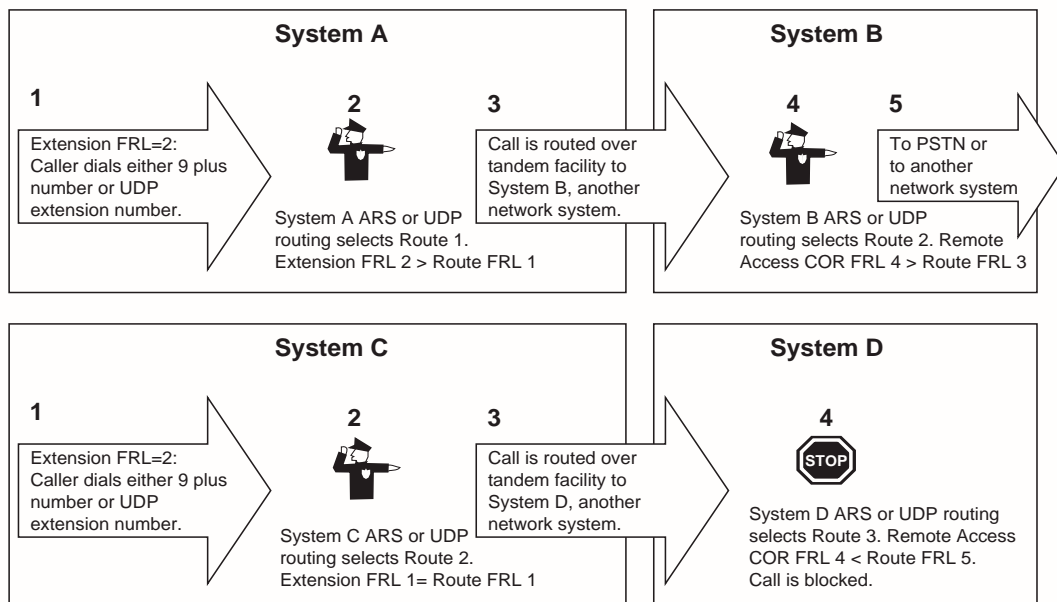

Figure 4-1. Facility Restriction Levels Applied to Network Calls

[Table 4-3](#) provides a quick reference to the way that route and extension or default COR FRLs are applied to calls.

Table 4-3. Facility Restriction Levels

---

Local Extension/Barrier Code Default COR/FRL	Local ARS or UDP Route FRL	Call Allowed?
0	0 only	Yes
0	1-6	No
1	0, 1	Yes
1	2-6	No
2	0-2	Yes
2	3-6	No
3	0-3	Yes
3	4-6	No
4	0-4	Yes
4	5-6	No
5	0-5	Yes
5	6	No
6	Any	Yes

---



# Network Management

# 5

---

This chapter summarizes the system programming required in order to set up and maintain a system within a private network. Full details of all procedures, including step-by-step programming instructions are included in *System Programming*. Before performing the system programming procedures outlined here, you should review the preceding chapters carefully.

This chapter includes the following major topics that summarize programming procedures for networking-only features, settings, and facilities:

- Non-Local Dial Plan Numbering
- Switch Identifiers
- Primary Rate Interface (PRI) Facility Switch Type (for tandem PRI trunks only)
- Uniform Dial Plan (UDP) Routing
- Display Preferences for Intersystem Calling

Each of the above topics presents planning guidelines, a list of tasks associated with programming the feature, and summary programming procedures.

In addition, other system programming procedures that are not new or enhanced for networking still require special planning and sometimes special programming for systems in private networks. These operations are described in the next topic.

## General Programming in Private Networks

---

This section outlines system features and programming options that may need adjustment or special planning when your system is included in a private network. This section includes the following topics:

- Pool Assignment
- Automatic Route Selection (ARS)
- Remote Access without Barrier Codes
- Clock Synchronization
- System Date and Time
- Tie Trunks
- Direct Inward Dialing (DID) Trunks
- For Release 6.1 and later, calling groups used for coverage to a non-local extension or calling group to route calls to centralized VMS/AA, non-local QCC, or other non-local facilities

### Pool Assignment

---

All tandem trunks must be assigned to pools. If tandem PRI trunk pools are available, these should be assigned to Route 1 in UDP patterns. For programming procedures, see "Trunks to Pools Assignment" in *System Programming*.

For 10xxx and 101xxxx equal access Interexchange Carrier (IXC), Dial 0, and N11 (for example, 411 or 911) calls from a collocated private networked system that is not connected to the PSTN, the tandem trunks must be assigned to the main pool so that these calls can be routed across the private network to another system's public switched telephone network (PSTN) trunks. For equal access calls, the system automatically prepends the local ARS access code, which *must* match the ARS code of the non-local system. For Dial 0 and the Special Numbers table, the ARS code must be prepended.



#### **CAUTION:**

*Unless private networked systems are collocated, each system should have at least one loop-start line connected to the PSTN. The line is required to allow connection of a power-failure telephone to the Power-Failure Transfer (PFT) jack on a module as a power outage backup and for correct routing of emergency and other N11 calls. To ensure that the correct services are reached, if the loop-start line is used for emergency or other N11 calls, it should be assigned to the main pool. In this case, IXC calls determine the number of loop-starts required. Refer to Feature Reference guide for details on the PFT feature.*

## Automatic Route Selection (ARS)

---

This topic describes two aspects of ARS as it is used in private networks:

- The general steps for setting up ARS in order to facilitate the use of PSTN facilities by non-local users
- ARS Facility Restriction Levels (FRLs) assigned to extensions and how their operation differs in a private network.

There are no new ARS programming procedures for private networked systems. However, existing procedures are used differently and the planning required for ARS takes the whole private network into consideration rather than just a single system.

### Setting Up ARS for Private Network Use

This topic describes the steps for modifying ARS in order to allow calling out on PSTN facilities connected to a non-local system in the private network. It also provides tips for system managers whose local PSTN lines/trunks are being accessed by remote users. This section does not summarize ARS procedures but instead points out the factors that you must consider. Before reviewing this information, read Chapter 2, "Call-Handling Scenarios" and Chapter 4, "Security." For programming procedures and details, see "Automatic Route Selection" in *System Programming*.

Follow these general steps:

1. **Pools.** Assign tandem trunks to pools.
2. **ARS Tables and Digit Manipulation.** At the system where calls originate, use one or more ARS tables for routing private network calls. The type of table required depends upon how users in your system will employ private networked lines. Typically, you might need an Area Code table. For example, if the remote system is in the 617 area code and your local system is in the 908 area code, the Area Code Table that you set up might include the entry 617.

All tables that specify tandem trunk pools must prefix the ARS access code of the remote system.

For all fully programmable ARS tables, ARS tables 17 & 18, Dial 0 table, and Special Numbers table, the Remote Access code must not be programmed in the prepended digits attributes table of each table.



#### **CAUTION:**

*Unless private networked systems are collocated, each system should have at least one loop-start line connected to the PSTN. The line is required to allow connection of a power-failure telephone to the Power-Failure Transfer (PFT) jack on a module as a power outage backup and for correct routing of emergency and other N11 calls. To ensure that the correct services are reached, if the loop-start line is*

*used for emergency or other N11 calls, it should be assigned to the main pool. In this case, IXC calls determine the number of loop-starts required. Refer to Feature Reference guide for details on the PFT feature.*

At the system where calls are delivered to the PSTN, digit manipulation may also be required. In the example above where calls are routed from the 908 area code to the 617 area code, the system in the 617 area code absorbs 1117. ARS tables can be used, under some circumstances, to send calls to yet another private network system. It may be necessary to add or absorb digits for further routing.

3. **Subpatterns.** At the system where calls originate, set up the subpatterns for the table. In doing so, you may wish to check with the non-local system manager to ensure that the local system routes associated with the primary time period (sub-pattern A) take advantage of non-local system routes associated with the secondary time period (sub-pattern B). If the non-local system is in a different time zone from your own, you may need to take this into consideration as well.
4. **Facility Restriction Levels.** At the system where calls originate, assign appropriate FRLs to the routes and to the extensions that will use the private network lines. Factory settings do not restrict toll calls. At the system where calls reach the PSTN, assign an FRL to the default class-of-restriction (COR) for the type of tandem trunk (non-tie for PRI and tie for all others). [“Facility Restriction Levels and Remote Access” on page 5](#) discusses this in detail.

## Facility Restriction Levels for Extensions

FRLs are assigned to extensions. These FRLs apply not only to ARS but to non-local UDP routing as well. Plan UDP, ARS, and extension FRLs carefully so that extension users can reach non-local extensions as needed and still be subject to required limitations on toll calling.

When local system users employ ARS in order to call out over PSTN facilities connected to a non-local system, the user's local system applies necessary restrictions using the ARS or UDP route FRL and the extension FRL. If the caller has dialed a Remote Access code included in the non-local dial plan on the calling system, the barrier code FRL on the called system is used instead of the extension FRL (barrier codes must be required for the default COR setting applied to the type of tandem trunk used). For the call to leave the local system, the extension or barrier code FRL must be equal to or higher than the route FRL. The extension FRL has no effect after the call leaves the local system. At the remote system, the route FRL is compared to the remote access default COR FRL, which acts in place of an extension FRL on a local system. For the call to go through, the remote access default COR FRL must be equal to or higher than the route FRL.



[“Facility Restriction Levels and Remote Access”](#) on page 5 discusses the interactions among FRLs in greater detail. For procedures that allow you to assign ARS FRLs to extensions, see *System Programming*.

## Remote Access with Barrier Codes

---

When non-local users access the PSTN facilities connected to your local system or private network calls are routed through your system, you use this procedure to specify default COR settings for all tie trunks (that is, all tandem tie trunks, analog or T1) and/or all non-tie trunks (that is, all tandem PRI trunks). Be sure to specify that remote access calls on these trunks *do require* barrier codes.



### SECURITY ALERT:

*Private network systems require special attention to security issues. Follow the rules below when setting up and planning your system for private network use.*

- *Ensure that barrier codes are required for incoming remote access calls received on PSTN PRI dial-plan routed and DID facilities, as well as those calls that are made from the local system by dialing the Remote Access code (889, for example). When you program the default COR, turn the barrier code requirement on. This setting is ignored for ARS calls and calls to non-local extensions across the private network. However, it is still applied to DID and PRI dial-plan routed remote access calls as well as to calls received on a tandem trunk and routed to a Remote Access code. Because the COR Calling Restriction must be set to unrestricted for private network calling, using barrier codes on these facilities is essential in order to apply security measures. When a Remote Access code is included in the non-local dial plan of the calling system, the caller's barrier code FRL on the called system is compared to the UDP or ARS route FRL on the called system. See the Feature Reference and [“Remote Access Default Class-of-Restriction Settings”](#) on page 6 for details.*
- *Extension and ARS FRLs should be carefully and stringently assigned in order to prevent unauthorized trunk-to-trunk transfers to local PSTN facilities. [Table 4-1, page 4-3](#) explains the operation of this feature in a private network system.*

The barrier code setting is ignored for UDP and ARS calls on tandem trunks, but applies to remote access calls that arrive from the PSTN on DID, PRI dial-plan routed, or tandem facilities for those UDP calls that are dialed using a Remote Access code included in the non-local dial plan. In a private network, these types of remote access calls should have restrictions applied to barrier codes and should not be restricted by default COR settings. In addition, barrier codes should be required for dial-in and dedicated/shared remote-access trunks used by remote access users on your own system. Do not assign private network networked trunks for dedicated remote access. For programming information, see *System*

*Programming.* For guidelines on setting up remote access COR settings, see [“Remote Access Default Class-of-Restriction Settings” on page 6.](#)

The remote access Automatic Callback setting of on or off does not apply to private network calls. Automatic Callback can be used at users' local system when all private networked trunks are busy.

Change the factory-set outward and toll restrictions on the private network trunks to allow ARS calling over the private network and to allow UDP extension calls to pass through the system. Necessary restrictions on PSTN trunks must be imposed by the system manager at the non-local system(s). Calling restrictions can and must still be applied to remote access barrier codes.

You should use the default remote access COR setting to assign the factory-set Disallowed List 7 to all tie and/or all non-tie tandem trunks. This Disallowed List prevents 900 and 976 calls, for example, as well as other types of calls frequently made by people who commit toll fraud. You may wish to add to this list if required by your organization's security needs. Do not assign any Allowed List to the default remote access COR.

## Clock Synchronization

---

Whenever digital signals are transmitted over a communications link, the receiving end must be synchronized with the transmitting end to receive the digital signals without errors. The system synchronizes itself by extracting a timing signal from an incoming digital stream. All the digital facilities operate from a common clock. This is called *clock synchronization*. The programming procedure for clock synchronization, described in *System Programming*, does not change for a system in a private network. However, in a private network, the tandem facilities connected to a system may require special planning for the best possible clock synchronization.

Primary synchronization of digital signals is backed up, in case of failure, by secondary and tertiary clock synchronization specified in system programming. This is important when a system has more than one digital facility. When a module or port is taken out of service for maintenance or its signal is otherwise disturbed, other digital facilities in a system still must be synchronized.



### NOTE:

If a T1 facility goes out of service at a remote system, the local MERLIN LEGEND system automatically switches its T1 clock synchronization to a secondary source (if one is programmed). When the T1 facility is restored, the local MERLIN LEGEND does not automatically switch the clock synchronization to the primary source; clock synchronization can be manually changed from the secondary source to the primary source.

As in a standalone system, a private networked system must derive clock synchronization from an in-service facility, not an unused or idle port. The best

source is a Digital Signal 1 (DS1) facility connected to a long-distance carrier rather than a local exchange carrier. A second choice is a Basic Rate Interface (BRI) or PRI facility connected to any PSTN carrier. The *Feature Reference* outlines these choices and other alternatives in its "Primary Rate Interface (PRI) and T1" section.

Clock synchronization derived from the PSTN, either via PRI or BRI facilities, is always preferable to a clock source that is provided by a digital tandem facility that is not connected to the PSTN. Private networked systems, however, may not have an in-service digital PSTN facility available or active. For this reason, clock synchronization in some private networks requires choosing from among other clock sources. This is accomplished by programming the clock sources as local (clock synchronization is provided by a 100D module installed in the local system) or loop (clock synchronization is provided by a DS1 module installed in a non-local system). There should be no more than one local clock source for digital tandem facilities in a private network, and all other tandem facilities are assigned as loop. A local clock source in a private network is not required; all can be programmed as loop.

In a private network with three or more systems, it is best if all clock sources for the private network are on either a hub system (star configuration) or a system that connects two other switches (series configuration). If the primary clock source is not functioning, then a secondary or tertiary source on such a system can serve either all other systems in the private network or two other systems in a private network. The following examples illustrate how clock synchronization can be implemented in a private network.

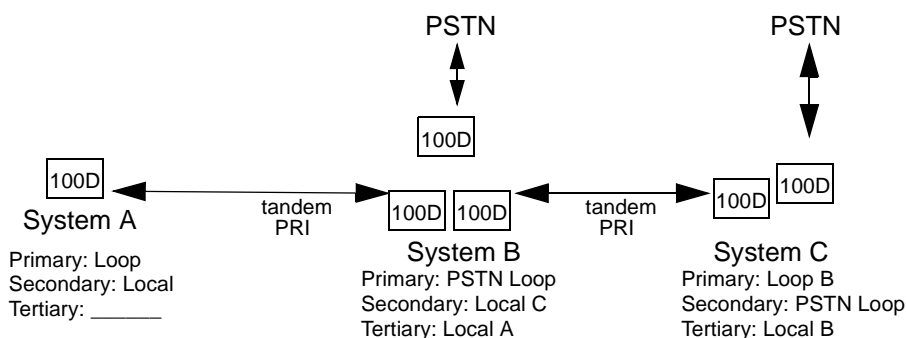

1. If tandem digital facilities link the systems in a private network and a non-local system is connected to functional digital PSTN facilities, a system with no digital PSTN facilities assigns its digital tandem lines as loop to derive the clock source from the system connected at the other end of the link. Synchronization is derived from the PSTN connection on one private networked system. The system connecting to the PSTN also assigns its clock source as loop because its clock source is at the far end of the PSTN

facility. In the diagram above, notice that System B has three 100D modules (and therefore three ports) to provide synchronization. (See the diagram above.)



**NOTE:**

If a DEFINITY ECS or DEFINITY ProLogix Solutions system is included in the private network and has functional digital PSTN facilities, it should provide the clock synchronization source.

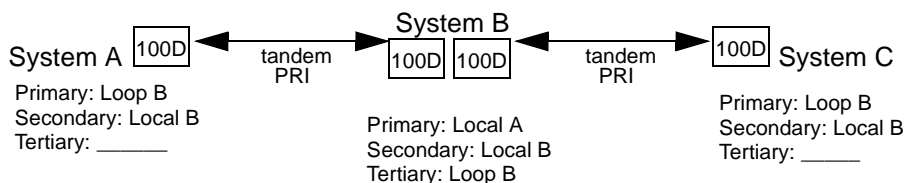

2. If a star configuration is linked by tandem digital facilities and has no in-service digital PSTN facilities connected to any switch, the primary clock in System B provides clock synchronization for the private network. (See the diagram above.)

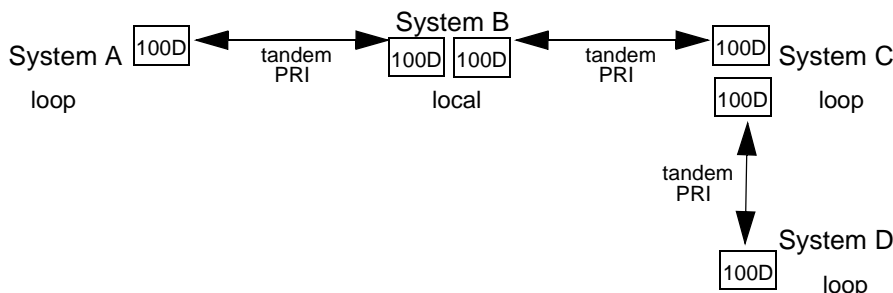

3. A private network in a series or combination star/series configuration linked by tandem PRI facilities has no in-service digital PSTN facilities connected to any switch. System B acts as the primary private network source. If System B has a total failure, System C provides clock to System D. (See the diagram above.)

## System Date and Time

For more information on system date and time, see *System Programming*. When a MERLIN LEGEND Communications System switch is in a private network with one or more other MERLIN LEGEND Communications Systems or with one or more DEFINITY ECS or DEFINITY ProLogix Solutions systems, Station Message Detail Recording (SMDR) reports may report outgoing calls using more than one call record, depending upon how SMDR is programmed and how calls are routed. If SMDR is reporting outgoing calls and users are employing private network lines to make these calls, ensure that the system date and time are set accurately on each system that carries these calls. As you examine call reports, you may need to be aware of time zone differences among private networked system locations.

## Tie Trunks

---

Program analog tandem tie trunks for delay-start seizure type, two way operation, E&M signalling type (as appropriate), the factory-set default disconnect time of 300 milliseconds, and touch-tone dialing. Refer to *System Programming* for detailed programming instructions.

Tandem T1 channels are programmed according to their use for voice or data. They are not dynamically allocated as PRI B-channels can be. For this reason, T1 tie channels are programmed either as TIE-PBX for T1-emulated voice channels or as S56 Data for data channels. A T1-emulated data channel supports up to 56 kbps per call. A 2B data call uses two data channels and up to 112 kbps. These facilities require the same type of DS1 programming that other T1 facilities do.

T1-emulated voice and data tie channels are programmed for delay-start seizure type, 2-way operation, touch-tone dialing, Ear & Mouth (E&M) signalling type (as appropriate) and the factory-set default disconnect and answer supervision times.

The system supports use of fractional T1 facilities for tandem trunking, so that you can order a point-to-point T1 circuit with just the number of channels (from 1 to 23) that you require. As required, the service provider supplies amplification but not the service carried on the channels; you program the service. You can also place drop-and-insert equipment on T1 facilities that link private networked systems, allowing the use of T1 channels for non-MERLIN LEGEND data/video communications between sites, while keeping the remaining channels for MERLIN LEGEND voice/data traffic. In either case, all 24 channels count towards the system maximum of 80 lines/trunks.

## DID Trunks

---

If your system includes DID trunks that route calls to non-local extensions, include the non-local extensions in your planning for DID trunks. You can, if necessary, delete all the digits from the DID numbers you have purchased from a service provider and substitute the non-local extension number (calling group number, for example) required for routing across the private network. Refer to *System Programming* for detailed programming instructions.

If DID calls are to be routed to 5-digit DEFINITY ECS or DEFINITY ProLogix Solutions system extension numbers, it is best if the DID trunks are directly connected to the DEFINITY ECS or DEFINITY ProLogix Solutions system, although digit prepending can be used on private networked MERLIN LEGEND Communications Systems to direct these calls. If digit prepending is used, include the last four digits of the DEFINITY ECS or DEFINITY Prologix Solutions system 5-digit extension, then use UDP routing to prepend the first digit.

## Group Calling Enhancement

---

In Release 6.1 and later, a calling group may have a *single* non-local member that is defined under the Uniform Dial Plan as existing on another MERLIN LEGEND Communications System connected by a tandem trunk. A calling group can have a single non-local member or several local extensions. The same calling group *cannot* have both local members and a non-local member.

A calling group containing a single non-local member can be used for most of the same purposes as a calling group containing only local extensions. This includes:

- **Night Service** coverage across a private network to a centralized Automated Attendant, non-local calling group, QCC queue, DLC, or any individual extension such as a night bell or an extension on a remote MERLIN LEGEND, DEFINITY ECS or DEFINITY Prologix system, or to the PSTN via UDP routing.
- **Group Coverage** across a private network to a centralized VMS/AA, non-local calling group, QCC queue, DLC, or any individual extension on a remote MERLIN LEGEND, DEFINITY ECS or DEFINITY Prologix system, or to the PSTN via UDP routing.
- **Calling group overflow coverage** to a centralized VMS/AA, non-local calling group, QCC queue, DLC, or any individual extension within a remote MERLIN LEGEND, DEFINITY ECS or DEFINITY Prologix system, or to the PSTN via UDP routing.



**NOTE:**

Be sure that overflow coverage does not go back and forth between systems because facilities will be tied up. Each leg of the call ties up a tandem trunk; release link is not provided. For example: System A calling group overflows to System B calling group and System B calling group overflows to system A calling group. In this case, if both are busy, the calls bounce back and forth tying up facilities along the way until an agent becomes available on one of the calling groups or until all trunks are busy.

- **QCC position busy backup** to a centralized VMS/AA, calling group, QCC queue, DLC, or any individual extension within a remote MERLIN LEGEND, DEFINITY ECS or DEFINITY Prologix system, or to the PSTN via UDP routing.



**NOTE:**

When the QCC queue is programmed as the unassigned extensions destination, VMS transfer returns are delivered to the first QCC position and are not sent to the QCC position busy backup destination.

The following considerations apply when using a calling group with a non-local member:

- If the pattern associated with the calling group has a route that includes PSTN trunks, each call over the PSTN has an associated cost.
- SMDR records for calls sent across a private network may be different from what is expected. For example, UDP calling may not be logged for part of the call. If a call from system A is routed through system B to system C and system A has SMDR turned on to log UDP calls, system B has SMDR turned off to log UDP calls and system C has SMDR turned on to log UDP calls, the call is logged at system A, not at system B and logged at system C.
- Calls sent to a calling group with a non-local member will never overflow locally. The calls are sent across the private network and the exact processing depends on the nature of the receiving extension on the far system. As a result, local delay announcement devices, queue alarm, external alert, and queue control will never be activated for a calling group with a non-local member.
- An extension on a MERLIN LEGEND system cannot be a member of a DEFINITY ECS or DEFINITY ProLogix hunt group.



**NOTE:**

The DEFINITY ECS “route to” step in vectoring can overflow calls to a non-local extension on a MERLIN LEGEND. However, no Look Ahead Interflow is provided and calls are recorded in BCMS and CSM as an “Outflow” call. For complete details, refer to DEFINITY ECS documentation.

- More than one calling group with a non-local member can be assigned on a system.
- A calling group with a non-local member cannot have a local member and a calling group with local members cannot have a non-local member.
- A non-local number can be a member of more than one calling group.
- When coverage calls using calling groups are routed across a private network, an MLX display telephone shows information about the call origination. It does not indicate that the call is a coverage call as would be the case for local coverage. Personnel who may receive coverage calls for non-local extensions should be advised of this difference in displayed information between local and non-local coverage. The exact information displayed depends on whether the tandem trunk connecting the systems is a PRI trunk or a tie trunk as shown below.

**Table 5–1. Cross-Network Display Information**

Tandem Type	Inside Calls	Outside Calls
PRI	Caller’s Name	Caller ID/ANI (as long as not answered)
Tie	Trunk Number	Trunk Number

## Centralized VMS/AA

---

Centralized VMS/AA is implemented using the Group Calling enhancement and UDP routing. Integrated VMI calling groups are defined on the VMS hub system and each remote system.

From the user's point of view, the routing is transparent. Users that travel between locations dial the same extension number from any location in the private network to reach the voice messaging system.

The integrated VMI calling group on the VMS hub system contains the voice messaging system ports. The integrated VMI calling groups on each remote system receive overflow, coverage, and voice mail retrieval calls and route them to the integrated VMI group on the VMS hub system.

Routing to the centralized VMS/AA is done by assigning a single non-local extension as a member of the integrated VMI calling group at each remote system sharing the centralized VMS/AA. This extension has no corresponding physical extension and is referred to as the *VMI conversion number* in this guide.



**NOTE:**

The VMI conversion number should not be published. This prevents users from dialing the VMI conversion number to retrieve messages, which can result in improper operation of the VMS/AA application.



## Centralized Voice Messaging Programming

Allowing the user to dial the same extension number to reach the centralized voice messaging system to retrieve messages regardless of location requires special programming that is described below:

- Select a calling group number to be used at the VMS hub systems and all remote systems sharing the centralized VMS/AA and renumber all systems' VMI calling group to the selected extension number (for example 7700). This is the number of an integrated VMI calling group that will receive coverage and overflow calls on all systems, and that can be dialed by users on all systems to access the voice mail system. Provide this extension number to all subscribers as the extension number used to reach the voice messaging system.
- At the (VMS hub) system where the centralized VMS/AA resides, program the following:
  - Establish a calling group for the centralized VMS/AA with the selected common extension for all VMI calling groups sharing the centralized VMS/AA in the private network (for example, 7700).
  - Assign the extension for the ports used to connect the centralized VMS/AA as members of the calling group and set the FRL for these extensions to 3.
  - Assign the calling group hunt type as required on the VMS/AA system requirements.
  - Assign the calling group type as Integrated VMI.
  - Assign other applicable parameters for the calling group as needed.
  - For individual local extensions that will receive coverage by the centralized VMS/AA, establish a coverage group. Assign the extensions as senders in the group and the centralized VMS/AA calling group as the receiver.
  - For calling groups that will receive overflow coverage to the centralized VMS/AA, assign the centralized VMS/AA calling group as the calling group overflow receiver.
- At each remote MERLIN LEGEND systems sharing the centralized VMS/AA, program the following:
  - Select an unused non-local extension number that is not included in any other range to be the VMI conversion number and assign it as a single-extension range. The number of dialed digits equals the number of digits for the VMI conversion number.
  - Assign a pattern for this VMI conversion number that is not used for normal private network calls. Set up the routes associated with the pattern as follows:
    1. Assign a private network facility pool that contains a pool of PRI or tie trunks, but not mixed trunk types.

2. Assign an FRL of 0.
  3. Specify the digit absorption parameter to absorb exactly the number of digits in the VMI conversion number. For example, if the VMI conversion number is 3738, specify 4.
  4. Specify the other (prepended) Digits parameter to add the extension number for the centralized VMSAA calling group on the VMS hub. For example, if the extension at the VMS hub is 7700, specify prepending 7700.
  5. Set voice/data attribute to Voice.
- Establish a calling group for the centralized VMS/AA and renumber the calling group to the selected common extension for all VMI calling groups sharing the centralized VMS/AA (for example, 7700).
  - Assign the VMI conversion number as the single member of this calling group.



**NOTE:**

The VMI conversion number should not be published. This prevents users from dialing the VMI conversion number to retrieve messages, which can result in improper operation of the VMS/AA application.

- Keep the factory-set calling group hunt type; since the calling group has only one member, the hunt type makes no difference.
- Assign the calling group type as Integrated VMI.
- Since the VMI calling group with a non-local member is always considered available, other applicable parameters such as calling group overflow receivers, delay announcement devices, queue alarm and queue control are not needed.
- For individual extensions at each system that will receive coverage by the centralized VMS/AA, establish a coverage group. Assign the extensions as senders in the group and the VMI calling group as the receiver.
- For calling groups that will receive overflow coverage to the centralized VMS/AA, assign the VMI calling group as the calling group overflow receiver.



**SECURITY ALERT:**

*To establish subscriber mailboxes, program the centralized VMS/AA to include all local and non-local covered extensions on any system. This is also necessary for security purposes so that the VMS can be restricted to transfer only to subscribers. See Appendix C for more information.*

## Centralized Automated Attendant Programming

Programming for a centralized automated attendant is the same as for a local automated attendant with the following differences:

- If incoming calls at remote systems are to be answered by the centralized automated attendant, establish a VMI calling group at each remote system. The extension for the VMI calling group at the remote systems does not have to be the same at all systems. Assign the lines to the VMI calling group and assign the extension for the centralized VMS/AA as the single non-local member. In this case the special routing (absorbing and prepending digits) is not required and a pattern used for routing other voice calls can be assigned to the range. The number of digits to dial must be assigned to the range (new programming for Release 6.0 V11 and Release 6.1 and later systems).



### SECURITY ALERT:

*Program the centralized VMS/AA to include all local and non-local covered extensions on any system. This is necessary for security purposes so that the automated attendant can be restricted to transfer only to subscribers. See Appendix C for more information.*

- All trunks within the private network should have unique trunk numbers. This allows the centralized automated attendant (such as Intuity) to deliver unique greetings based on the trunk on which the call was received.

## Non-Local Dial Plan Numbering

---

As part of implementing a private network, the system manager at each private networked system specifies ranges of extensions for non-local systems connected directly or via another private network system to the local MERLIN LEGEND Communications System. The process does not affect programming on non-local systems but allows smooth communications among private networked systems.

This topic describes the following two management tasks:

- Specifying new extension number ranges
- Deleting extension number ranges

The extension ranges you enter using this procedure include the numbers that users on your system dial in order to make System Access (**SA**) calls to users on a non-local system. Users dial these calls in the same way that they dial inside calls on your local system. Numbering must be planned to avoid conflicts and provide unique and unambiguous extension numbers across private networks.

Non-local dial plan calls are routed over pools of private trunks using UDP routing. To maintain existing dial plans when systems are networked or when one system's dial plan changes, UDP routing provides digit absorption and digit prepending, allowing dialed numbers to be modified before they are actually sent to the remote system. These techniques can be used to route DID and PRI dial-plan routed calls. For additional information about UDP routing, see [“Switch Identifiers” on page 19](#).

## Planning Guidelines

---

When you specify a non-local extension range, the system verifies that extension numbers on the local system do not conflict with those programmed on a private networked switch. For example, if Extension 110 exists in the local system, Extension 1100 cannot be included in the extension range for a non-local private networked system. The local system also checks to see whether new extension number ranges conflict with existing ranges programmed for non-local systems.

In Release 6.0 V11 and later systems, when specifying a non-local extension range, you must also specify the number of dialed digits. This speeds call setup by allowing the system to route a call when the proper number of digits expected are received. An entry of 1-11 dialed digits is required; there is no factory setting.

MERLIN LEGEND Communications System non-local dial plan numbering specifies extensions up to four digits long, while DEFINITY ECS and DEFINITY ProLogix Solutions systems may have 5-digit extension numbers. There are two methods you can use to number DEFINITY ECS or DEFINITY ProLogix Solutions non-local dial plan ranges to match the five digits. Choose one of the following techniques, depending upon the actual extension numbers you are entering in ranges and potential conflicts:

- Specify ranges in MERLIN LEGEND that include the first four digits in the extension numbers. Each number you enter in the range represents 10 numbers in the remote 5-digit system. For example, an extension range entered as 4321 through 4322 represents remote extensions 43210 through 43229. Users actually dial five digits. The local system recognizes the number range by the first four digits, but sends all five digits to the DEFINITY ECS or DEFINITY ProLogix Solutions system. In this example, the number of dialed digits is set to 5.
- Enter the last four digits and use UDP routing to prepend the first digit in the DEFINITY ECS or DEFINITY ProLogix Solutions extension number. The local system recognizes the number range using the last four digits. Users dial only the last four digits. If DID calls must reach 5-digit DEFINITY ECS or DEFINITY ProLogix Solutions extensions from a MERLIN LEGEND Communications System, this method of routing should be used but it is recommended that DID facilities be connected directly to the local DEFINITY ECS or DEFINITY ProLogix Solutions systems. For details about UDP routing, see [“Uniform Dial Plan Routing” on page 25](#). In this example, the number of dialed digits is set to 4.

An extension number range may stipulate a single extension number. For Release 6.1 and later systems, the single non-local extension member (called the VMI conversion number) assigned to an integrated VMI calling group used to route calls to a centralized VMS/AA must be the only extension assigned to an extension range. This allows UDP routing to absorb all dialed digits and prepend the extension number for the centralized VMS/AA calling group at the central site.

You can use inspect to review extension ranges. To see a report of existing non-local extension ranges, select the Print option on the System Programming menu and then choose NonLc1 UDP. Appendix B, "Network Reports," includes a sample.

On a single MERLIN LEGEND system, you can specify up to 50 ranges. Each range has an associated pattern. On a single MERLIN LEGEND, you can specify up to 20 patterns. A pattern can be used by more than one range. Each pattern specifies as many as four routes. A route specifies a pool, FRL, number of digits to absorb, digits to prepend, and voice/data call type. Consider DID and PRI dial-plan routing when setting up these ranges. For more information, see ["Uniform Dial Plan Routing" on page 25](#).

When the numbering of a non-local system changes, the local system manager should check the new non-local numbers and ascertain the impact on both the local and non-local dial plans, then make changes manually for non-local extension ranges.



**NOTE:**

Renumbering of non-local extensions on the local system does not put those extensions in the forced-idle condition on the remote system.



**SECURITY ALERT:**

*If barrier codes are **not** required, these calls receive default COR for non-tie trunks. If the system uses tandem PRI trunks for ARS to route calls through the system, then the calling restriction option of the default COR must be set to unrestricted. This can lead to toll fraud.*

**Valid Entries**

**New extension ranges:** Starting and ending numbers for non-local extension ranges; number of dialed digits for the extension (Release 6.0 V11 and later systems), range 1-11

**Deleting extension ranges:** Starting numbers for non-local extension ranges to be deleted

## Task List: Non-Local Dial Plan Numbering

---



**NOTE:**

Any local dial-plan changes should be made before you program the non-local dial plan.

- Obtain Non-Local UDP Administration Form. A copy is located in the Installation Specification, Non-Local Dial Plan Numbering.
- Read Chapter 2, "Call-Handling Scenarios," for examples of non-local dial plans.
- Plan changes or new extension ranges using the planning guidelines above and after consulting other system managers in the private network. Record the new values on the form.
- Open the System Programming menu from the console or a PC with SPM.
- Program the change(s), following the instructions below, or consult "Non-Local Dial Plan Numbering" in *System Programming*.
- When you have finished, file the form with the rest of the planning forms.

## Programming Instructions

---



**NOTE:**

In the following instructions, additions or changes are not saved until you enter the pattern number and select Enter (**F10**).

- |                   |  |
|-------------------|--|
| Console Procedure | <p>To specify new extension ranges:<br/>                 SysRenumber→NonLocal UDP→Dial no. of first extension in range→Enter→Dial no. of last extension in range→Enter→Dial no. of dialed digits in extension range→Enter→Dial no. of pattern for extension range→Enter→Exit→Exit→Exit</p> <p>To delete extension ranges:<br/>                 SysRenumber→NonLocal UDP→Dial no. of first extension in range→Enter→DelRange→Exit→Exit</p>        |
| PC Procedures     | <p>To specify new extension ranges:<br/> <b>F2</b>→<b>F4</b>→Type no. of first extension in range→<b>F10</b>→Type no. of last extension in range→<b>F10</b>→Type no. of dial digits in extension range→<b>F10</b>→Type no. of pattern for extension range→<b>F10</b>→<b>F5</b>→<b>F5</b>→<b>F5</b></p> <p>To delete extension ranges:<br/> <b>F2</b>→<b>F4</b>→Type no. of first extension in range→<b>F10</b>→<b>F8</b>→<b>F5</b>→<b>F5</b></p> |

## Switch Identifiers

---

If your system uses private tandem trunks, you *must* program switch identifiers. Switch identifiers are 1- or 2-digit numbers that are used by the system to identify transmission levels and check routing. Switch identifiers indicate the switch connected to the far end of a local private trunk.

Switch identifiers appear in print reports. You can use Next to see the switch identifiers for all trunks. To see a report showing switch identifiers, select the **Print** option on the System Programming menu and then choose **Trunk info** and **General**. See Appendix B for an example of the General Trunk Information report. The switch identifier appears in the "Extern Switch" column.

## Planning Guidelines

---

The procedures in this topic allow you to add, change, and remove switch identifiers.

PSTN trunks connected to your local system do not require identifiers. They are, by default, not assigned an identifier.

When a private networked trunk is deleted, either via DS1 programming or by the Board Renumber procedure, **all** switch identifiers in the system need to be examined and reprogrammed as needed. Newly added private network trunks need to be programmed with new switch identifiers.

You can assign a switch identifier to a block of trunks. You can also remove a switch identifier from a block of trunks that use the same switch identifier.

The correct switch identifier for a trunk or block of trunks is determined by the type of switch to which the trunk is connected and whether or not that switch is a *satellite* switch (located within 200 miles of the local system). It is important to know the distance between systems in order to assure transmission quality. The identifiers are switch numbers that have the following meanings:

- Unassigned, no value = trunk connected to CO (central office)
- 1–20 = trunk connected to a non-satellite MERLIN LEGEND Communications System
- 21–40 = trunk connected to a satellite MERLIN LEGEND Communications System
- 41–50 = trunk connected to a non-satellite system that is not a MERLIN LEGEND Communications System (for example, a DEFINITY ECS)
- 51–60 = trunk connected to a satellite system that is not a MERLIN LEGEND Communications System (for example, a DEFINITY ProLogix Solutions communications system)



**NOTES:**

1. The Enter Switch Number screens for the switch identifier procedures include a Help option that supplies most of the information above.
2. For information about DEFINITY ECS or DEFINITY ProLogix systems, consult the documentation for the system.

A switch identifier should be unique across a private network. This helps avoid a situation called *automatic immediate cycling*. For example, when the switch identifiers for the incoming trunks and the automatically selected outgoing trunks for a call match indicating the tandem call would return to the originating switch, another route for the call is selected if possible. However, if all available routes specify systems with matching switch identifiers, the caller hears a fast-busy tone. The call is routed to the destination system and then back to the originating system in a continuous loop, until all available trunks are used.

A switch may be a satellite for one private networked system but not a satellite for another private networked system. In this case, a system may have more than one switch identifier. For example, in the diagram below, System D is located within 200 miles of System E but more than 200 miles from System F in the same private network. In this case, the switch identifier for System D as specified in System E is different from the identifier for System D as specified in System F.

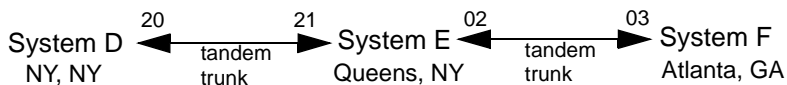

This topic includes procedures for adding a switch identifier to a single trunk or to a block of sequentially numbered trunks.

**Valid Entries**

Unassigned, 1–20, 21–40, 41–50, 51–60

**Task List: Switch Identifiers**

---

- Obtain Form 2c, System Numbering: Line/Trunk Jacks.
- Plan changed or new switch identifiers using the planning guidelines above and after consulting other system managers in the private network. Record the new values on the form.
- Open the System Programming menu from the console or a PC with SPM.
- Program the change(s), following the instructions below or those for “Switch Identifiers” in the “UDP Facilities” section of *System Programming*.
- When you have finished, file the form with the rest of the planning forms.



## Programming Instructions

---

Console Procedures To enter an identifier for one trunk:  
LinesTrunks→**More**→UDP→SwNum-Single→Dial trunk  
no.→Enter→Dial switch no.→Enter→Exit→  
Exit→Exit

To enter an identifier for a block of trunks:  
LinesTrunks→More→UDP→SwNum-Block→Dial starting  
trunk in block→Enter→Dial ending trunk in block→  
Enter→Dial switch no.→Enter→Exit→Exit→Exit

To delete an identifier for one trunk:  
LinesTrunks→**More**→UDP→SwNum-Single→Dial trunk  
no.→Delete→Exit→Exit→Exit

To delete an identifier for a block of trunks:  
LinesTrunks→More→UDP→SwNum-Block→Dial starting  
trunk in block→Enter→Dial ending trunk in block→  
Delete→Exit→Exit→Exit

### PC Procedures

To enter an identifier for one trunk:  
[F4]→[PgUp]→[F10]→[F1]→Type trunk no.→[F10]→Type  
switch no.→[F10]→[F5]→[F5]→[F5]

To enter identifiers for a block of trunks:  
[F4]→[PgUp]→[F10]→[F2]→Type starting trunk in block→  
[F10]→Type ending trunk in block→[F10]→Type switch  
no.→[F10]→[F5]→[F5]→[F5]

To delete an identifier for one trunk:  
[F4]→[PgUp]→[F10]→[F1]→Type trunk no.→[F8]→[F5]→  
[F5]→[F5]

To delete an identifier for a block of trunks:  
[F4]→[PgUp]→[F10]→[F2]→Type starting trunk in block→  
[F10]→Type ending trunk in block→[F8]→[F5]→  
[F5]→[F5]

## Tandem PRI Facilities

---

This topic presents considerations for managing tandem PRI facilities connected to your local system in a private network.

If your system includes PSTN PRI facilities that route calls to non-local extensions, you also need to consult the procedures in the “Dial Plan Routing” topic of “PRI Facilities,” *System Programming*. You can, if necessary, delete all the digits from PRI calls received on a system and substitute the non-local extension number (calling group number, for example) required for routing across the private network.

When you order facilities for PRI, you specify a T1 point-to-point circuit; the service provider may supply amplification but not PRI service or switching. Program the circuit for PRI, following the instructions in *System Programming* for both DS1 and PRI. Tandem PRI trunks should be programmed for Extended Superframe (ESF) format, which detects errors more reliably than other formats. In addition, tandem PRI trunks should be programmed for bipolar 8 zero substitution (B8ZS) line coding. If alternate mark inversion (AMI) line coding is used, 64-kbps data calls (128 kbps for 2B data) are not supported. If D4 framing is used maintenance is more difficult. The framing and line coding must be verified with the service provider. However, 56-kbps data calls are supported (112 kbps for 2B data).



**NOTE:**

Verify that any Channel Service Unit (CSU) on the DS1 circuit between the MERLIN LEGEND Communications System and the PSTN is programmed for the same framing as the DS1 slot on the MERLIN LEGEND Communications System.

You may place drop-and-insert equipment between systems connected by a PRI tandem facility, allowing use of fewer than 23 B-channels. Some channels are reserved in this way for non-MERLIN LEGEND communications, and the remaining are dedicated to MERLIN LEGEND voice/data traffic. The equipment must never drop Channel 24, the D-channel. All 24 channels still count toward the system maximum of 80 lines. For channels not used by the MERLIN LEGEND system, lines and B-channels must be removed from the B-channel group.



**NOTE:**

When connecting to a DEFINITY ECS or DEFINITY Prologix, the DEFINITY must provision all 23 B-channels and allow MERLIN LEGEND to take out of service any B-channels that were dropped, then DEFINITY can unprovision those channels.

## PRI Facilities Switch Type

---

In this procedure, two additional switch types allow you to specify additional switch options in order to set up a PRI tandem trunk that connects two MERLIN LEGEND Communications Systems or a MERLIN LEGEND Communications System and a DEFINITY ECS or DEFINITY ProLogix Solutions system. The two additional options are the following:

- MERLIN LEGEND Communications System Networked: LEGEND-Ntwk
- MERLIN LEGEND Communications System PBX: LEGEND-PBX

## Planning Guidelines

To set up a PRI tandem trunk, one system is specified as operating in PBX mode and the other as operating in network mode. When you program this switch type, you specify the type of switch at the *other* end of the PRI trunk, not the local switch. The slot number that you enter is the slot number on the local system.

In Release 6.1 and later systems, the PRI Switch Type Test requests the system at the other end to respond with information about the PRI Switch Type specification. Lucent Technologies technicians or authorized representatives can run this test to determine the PRI Switch Type at the other end.

The following rules apply to PRI tandem trunks in PBX or network mode:

- A single unused B-channel group number is automatically assigned to all 23 B-channels on the trunk; B-channels on the same module may be removed or added manually at a later time. The system finds an unassigned group number by starting at group 80 and searching backward. This group can exist, even if all B-channels are removed manually. For more information, see “B-Channel Groups” in the “PRI Facilities” section of *System Programming*.
- PRI dial-plan routing does not apply for incoming calls on the PRI tandem trunk. Incoming routing is automatically set to Route Directly to UDP for B-channels in the automatically assigned group; this cannot be changed as long as the LEGEND-PBX or LEGEND-Ntwk switch type is in effect. For more information, see “Incoming Call Routing” in the “PRI Facilities” section of *System Programming*.
- PRI outgoing call tables do not apply to outgoing calls on the PRI tandem trunk.
- The system automatically assigns Electronic Tandem Network (ETN) as the network service for the B-channel group that is automatically assigned to the PRI tandem trunk; this setting cannot be changed as long as the switch type is in effect. For more information, see “Network Service” in the “PRI Facilities” section of *System Programming*.

- The Copy Telephone Number to Send setting is set to Copy for the PRI tandem trunk B-channel group; this setting cannot be changed as long as the switch type is in effect. For more information, see “Copy Telephone Number to Send” in the “PRI Facilities” section of *System Programming*.

DEFINITY ECS and DEFINITY ProLogix Solutions systems use the Interface field to specify the equivalent of a switch type. It identifies a slot on the local system as Network or User. User is the usual setting. If the Interface field specifies Network, the MERLIN LEGEND Communications Systems slot specifies LEGEND-Ntwk. If the Interface field specifies User, the MERLIN LEGEND Communications Systems specifies LEGEND-PBX. DEFINITY ECS and DEFINITY ProLogix Solutions system documentation provides details about the Interface field.

### Task List: Switch Type

- Obtain Form 3b, Incoming Trunks: DS1 Connectivity (100D module).
- Read Chapter 2, “Call-Handling Scenarios,” to see examples showing Switch Type settings for different private network configurations.
- Plan changed or new switch types using the planning guidelines above and after consulting other system managers in the private network. Record the new values on the form.
- Open the System Programming menu from the console or a PC with SPM.
- Program the change(s), following the instructions below or those for “Switch Type” in the “PRI Facilities” section of *System Programming*, or the summary programming instructions below.
- When you have finished, file the form with the rest of the planning forms.

### Programming Instructions

Console Procedure      LinesTrunks→PRI→SwitchType→Dial slot no.→  
 Enter→Specify switch type→Enter→Exit→Exit

PC Procedure            (F4)→(F6)→(F9)→Type slot no.→(F10)→Specify switch  
 type →(F10)→(F5)→(F5)

## Uniform Dial Plan Routing

---

This section includes programming procedures for assigning UDP routing. UDP routing is very similar to ARS, except that it is slightly simpler. UDP routing allows system users to reach non-local extensions at a remote DEFINITY ECS or DEFINITY ProLogix Solutions or MERLIN LEGEND Communications System that is networked to your system. UDP routing associates the dialed extension number with one of up to 20 programmed patterns. For each pattern you can specify up to four routes. For each route, you specify a pool dial-out code. Then you can program FRLs, absorbed digits, prepended digits, and voice and/or data capability.

You can use inspect to review existing routes. To see a report of existing non-local extension ranges, select the Print option on the System Programming menu and then choose NonLc1 UDP. Appendix B, "Network Reports," includes a sample.



### NOTE:

Before using this procedure, assign all private tandem trunks connected to your system to pools. Then assign pools to routes in pattern, if you remove or change a pool number for a route, all the routing information returns to default values: FRL 3, no prepended or absorbed digits, both voice and data capability. In addition, you should assign patterns to non-local extension ranges, which is part of numbering the extensions. To perform this procedure, see ["Non-Local Dial Plan Numbering" on page 15](#).

This section contains programming procedures for the following UDP routing features:

- UDP Routes
- FRL
- Digit Absorption
- Other (Prepended) Digits
- Voice and/or Data Routing

## Planning Guidelines

---

There are five steps in programming UDP routes:

1. Assigning pools of tandem trunks to UDP routes
2. Assigning FRLs to routes
3. Specifying the number of dialed or received digits that should be absorbed, starting with the first dialed digit
4. Specifying the digits that should be prepended to the number that results in Step 3
5. Specifying, for tandem trunks, voice capability, data capability, or both

## UDP Routes

In UDP routing, routes 1–4 are associated with patterns, which are assigned first by associating non-local dial plan extension ranges with those patterns. You can use up to 20 patterns and up to 50 extension ranges. A pattern can be assigned to as many extension ranges as necessary. Each route has various attributes (FRL, digit absorption, and so on) for call delivery.

Route 1 has the highest priority and should specify a pool of tandem PRI trunks if such facilities are connected to the system. Pools should contain the same type of facilities. If a caller uses Callback, the call queues for Route 1 only. Usually, PSTN routes should have the highest FRL numbers, which are the most restrictive and are only included for use by particular users when tandem trunk pools are unavailable.

In many cases, only one pool may be needed. However, multiple pools can help prioritize certain types of calls and maximize the use of shared facilities.

You can use inspect to review existing routes.

### *Valid Entries*

Pattern (1–20)

Routes (1–4)

## Facility Restriction Levels

FRLs assigned to extensions apply not only to ARS calls but also to calls for non-local UDP extensions connected by private trunks to your local system. Use care in assigning FRLs both to extensions and to UDP routes. For example, if a user must be restricted from toll calls on your local system, you may need to plan UDP routes' FRLs to be unrestricted, so that the user can reach necessary non-local UDP extensions.

Use the following guidelines to assign a FRL to each UDP route. The FRL ranges from 0 (least restrictive) to 6 (most restrictive). When a user makes a call that requires UDP routing, the user's extension FRL (or in some cases, remote access barrier code FRL) must be equal to or higher than the route FRL in order for the call to go through. When a call arrives at a remote private networked system, the remote access default COR FRL specified in the remote system for the type of tandem trunk carrying the call (tie or non-tie) replaces the user's extension FRL in the comparison to the UDP or ARS outgoing route FRL. For an extension FRL or default COR FRL, a value of 0 is the most restrictive, and a value of 6 is the least restrictive. The interaction of FRLs is described in ["Facility Restriction Levels and Remote Access" on page 5](#).

The factory setting for each FRL is 3.

**NOTE:**

Extension outward and toll calling restrictions are ignored when a user dials a non-local dial plan extension. However, FRL extension restrictions remain in effect.

For Release 6.1 and later, when using a centralized VMS/AA, at the (VMS hub) system where the centralized VMS/AA resides, assign the extension for the ports used to connect the centralized VMS/AA as members of an integrated VMI calling group and set the FRL for these extensions to 3.

At each remote MERLIN LEGEND system sharing the centralized VMS/AA, assign a pattern for the integrated VMI conversion number that is not used for normal private network calls. Set up the routes associated with the pattern as follows:

- Assign a private network facility pool that contains a pool of PRI or tie trunks, but not mixed trunk types.
- Assign an FRL of 0.

***Valid Entries***

0 to 6

**Digit Absorption**

Use this procedure to specify how many of the digits dialed (0 through 11) by the caller should be absorbed (not sent over the trunk) by the system when a UDP call to a non-local extension is made on an identified route. Digit absorption can be used to modify the digits that are actually sent to a non-local system.

For Release 6.1 and later, when coverage or overflow calls are routed to a centralized VMS/AA, the same extension number is assigned to the integrated VMI calling group created on each system sharing the centralized VMS/AA (including the VMI hub system). This configuration allows users to dial the same extension number to retrieve voice mail messages regardless of location. For each remote system, the number of digits absorbed should equal the length of the VMI conversion number (the non-local member in the integrated VMI calling group used to route calls to the centralized VMS/AA). The VMI conversion number has no corresponding physical extension. Digit absorption removes the VMI conversion number so that the extension for the centralized VMS/AA at the VMI hub can be added by prepending.

Entries of 1 through 11 indicate that the system should not send the specified number of digits, starting with the first digit dialed by the user.

**NOTE:**

Do not use this procedure to overcome conflicts between local and non-local extension numbering. Such conflicts can result in numerous problems with system features and should be resolved by system renumbering of the affected systems.

The factory setting is 0.

*Valid Entries*

0 to 11

## Other (Prepended) Digits

Use this procedure to specify other (extra) digits that must be prepended by the system to the remaining after any absorption when calls are placed on an identified route. You may need to prepend a digit in order to accommodate the 5-digit numbering of DEFINITY ECS or DEFINITY ProLogix Solutions communications system extensions in your private network.

Other digits can also be used to specify alternate routing if private network trunks to another private network system are unavailable and the remote system has dial-in facilities. Use other digits to prepend the required area code and exchange to route the call via the PSTN to the remote private network system.

For Release 6.1 and later, when coverage or overflow calls are routed to a centralized VMS/AA, the same extension number is assigned to the integrated VMI calling group created on each system sharing the centralized VMS/AA (including the VMI hub system). This configuration allows users to dial the same extension number to retrieve voice mail messages regardless of location. For each remote system, digit absorption removes the VMI conversion number (the non-local member in the integrated VMI calling group used to route calls to the centralized VMS/AA). On each remote system sharing the centralized VMS/AA, use the Other Digits options to prepend the extension for the centralized VMS/AA at the VMI hub.

Unless a user employs a **Pool** button or pool dial-out code, which they should not, the dialed digits correspond to the non-local dial plan numbering.

**NOTE:**

Do not use this procedure to overcome conflicts between local and non-local extension numbering. Such conflicts can result in numerous problems with system features and should be resolved by system renumbering of the affected systems.

A maximum of 20 digits can be added, in any combination of digits 0 through 9.



Special characters such as \*, Stop, and # cannot be included as extra digits. Pause is allowed in every position but the first.



**NOTE:**

Digit absorption is applied before digit prepending.

The factory setting is empty.

*Valid Entries*

Up to 20 digits (any combination of 0 to 9 and **HOLD (P)**, for Pause)

## Voice and/or Data Routing

For UDP routing, the voice/data attribute is used in conjunction with PRI tandem trunks.

The voice/data attribute can be associated with any UDP route.

The factory setting is Voice/Data.

*Valid Entries*

Voice Only, Data Only, Voice/Data

## Task List: Uniform Dial-Plan Routing

---

- Obtain Non-Local UDP Administration Form in the Installation Specification, UDP Routing.
- Plan changed or new non-local UDP routes using the planning guidelines above and after consulting other system managers in the private network. Record the new values on the form.
- Ensure that tandem trunks have been assigned to pools. If necessary, consult "Trunks to Pools Assignment" in the "Lines and Trunks" section of *System Programming*.



**NOTE:**

To avoid confusion and for future planning purposes, tandem trunks and pools of tandem trunks should be numbered uniquely and unambiguously.

- Open the System Programming menu from the console or a PC with SPM.
- Program the change(s), following the instructions below in the order shown, or those for "UDP Routing" in *System Programming*.
- When you have finished, file the form with the rest of the planning forms.

## Programming Instructions

Console Procedures

To specify routes:  
 Tables→UDP Routing→Dial pattern no.→Enter→Dial route no.→Enter→Pool→Dial pool dial-out code→Enter→Exit→Exit→Exit→Exit

To assign FRLs to routes:  
 Tables→UDP Routing→Dial pattern no.→Enter→Dial route no.→Enter→FRL→Dial restriction level→Enter→Exit→Exit→Exit→Exit

To assign digit absorption to routes:  
 Tables→UDP Routing→Dial pattern no.→Enter→Dial route no.→Enter→Absorb→Press **Drop**→Dial number of absorption digits→Enter→Exit→Exit→Exit→Exit

To assign prepended digits to routes:  
 Tables→UDP Routing→Dial pattern no.→Enter→Dial route no.→Enter→Digits→Press **Drop**→Dial digits to add→Enter→Exit→Exit→Exit→Exit

To assign voice and/or data attribute to tandem routes:  
 Tables→UDP Routing→Dial pattern no.→Enter→Dial route no.→Enter→Data→Select capability→Enter→Exit→Exit→Exit→Exit

PC Procedures

To specify routes:  
 [F8]→[F7]→Enter pattern no.→[F10]→Type route no.→[F10]→[F1]→Type pool dial-out code→[F10]→[F5]→[F5]→[F5]→[F5]

To assign FRLs to routes:  
 [F8]→[F7]→Enter pattern no.→[F10]→Type route no.→[F10]→[F2]→Type restriction level→[F10]→[F5]→[F5]→[F5]→[F5]

To assign digit absorption to routes:  
 [F8]→[F7]→Enter pattern no.→[F10]→Type route no.→[F10]→[F3]→[Alt]+P→Type number of digits to absorb→[F10]→[F5]→[F5]→[F5]→[F5]

To assign prepended digits to routes:  
 [F8]→[F7]→Enter pattern no.→[F10]→Type route no.→[F10]→[F4]→[Alt]+P→Type digits to add→[F10]→[F5]→[F5]→[F5]→[F5]

To assign voice and/or data attributes to tandem PRI routes:  
 [F8]→[F7]→Enter pattern no.→[F10]→Type route no.→[F10]→[F5]→Select capability→[F10]→[F5]→[F5]→[F5]→[F5]

## Display Preferences for Intersystem Calls

---

Use this procedure to specify display preferences on MLX display telephones, for incoming PSTN calls or non-local dial plan calls that arrive on PRI tandem trunks. Non-local dial plan calls that arrive on private networked tie or T1 trunks are not affected; such calls display on the recipient's telephone as outside calls. For details about the display content, see the intersystem calling examples included in Chapter 2, "Call-Handling Scenarios."

The factory setting specifies display of the calling number.

### *Valid Entries*

Calling Name, Calling Number, Both

## Task List: Display Preferences for Intersystem Calls

---

- Obtain Non-Local UDP Administration Form in the Installation Specification, Display Preferences.
- Open the System Programming menu from the console or a PC with SPM.
- Program the change(s), following the instructions below or those for "Display Preference" in the "Optional Extension Features" section of *System Programming*.
- When you have finished, file the form with the rest of the planning forms.

## Programming Instructions

---

Console Procedure      Extensions→**More**→**More**→DisplayPref →Dial  
extension no.→Enter→Select display option→  
Enter→Exit→Exit

PC Procedure            **F6**→PgUp→PgUp→**F4**→Type extension no.→**F10**→  
Select display option→**F10**→**F5**→**F5**



# Troubleshooting

# 6

---

This chapter helps you analyze and solve some common private network calling problems that users of your system may encounter. Each problem is summarized, with possible causes and solutions. Most problems listed here originate in system programming on one or more systems in a private network. Before attempting to handle these issues, you should be familiar with the preceding chapters in this guide.

In many cases, the coordinating system manager must review programming in order to arrive at solutions.



**NOTE:**

If your private network consists of more than two systems, a system manager in the private network should be appointed to maintain system forms for all systems in the private network. Any local modifications should be cleared with this coordinating system manager, who must ensure that changes to a local system do not have undesirable effects on the private network as a whole. When modifications are made, he or she should see that corresponding changes are made, as necessary, at networked systems. If your private network consists of two systems, the managers should work together to assess and agree upon any changes.

## Troubleshooting Guidelines and Preparation

---

Before troubleshooting problems, obtain copies of your system's planning forms. Many of the solutions offered in this chapter require that you contact the coordinating system manager in your private network, who maintains records of how systems in your private network are programmed and keeps them up to date. Problems can occur when changes are made in a private network without considering the needs of the private network as a whole. In particular, changes to local and non-local dial plans, Uniform Dial Plan (UDP) routes, Automatic Route Selection (ARS) routes, and remote access settings can have unintended effects on other systems in your private network.

To solve a problem, you may need to perform system programming using your MLX-20L programming console or PC equipped with System Programming and Maintenance (SPM) software.

Most of the problems outlined here can be solved by system managers working together in a two system private network or with the coordinating system manager in a larger private network. However, some problems require the intervention of a Lucent Technologies technician. In the USA only, Lucent Technologies provides a toll-free customer Helpline (1 800 628-2888) 24 hours a day. You may want to allow only the coordinating system manager to contact the Helpline, because this person has the complete information that allows Lucent Technologies technicians to understand problems that you are experiencing. Under certain circumstances, you may be charged for consultation with Helpline personnel. Contact your Lucent Technologies representative or authorized dealer, if you have any questions concerning consultation charges.

The troubleshooting instructions in this chapter provide information about reviewing current programming on your local system. You can find out about current programming in the following three ways:

- **System Forms.** Review the filled-out system form that includes the programming information you need. This method requires that forms be available and up-to-date.
- **System Reports.** Appendix B, "Sample Reports," includes samples of reports that you may require when troubleshooting private network problems, along with the menu options for selecting each report. To see a report, select the **Print** option on the System Programming menu and then choose a report. The *Feature Reference*, Appendix F, includes samples of all system reports.
- **System Programming.** Many of the system programming procedures that you may need to perform are summarized in Chapter 5, "[Network Management](#)." *System Programming* includes instructions for accessing system programming by using the MLX-20L console or SPM software on a personal computer. The troubleshooting instructions also cite procedures from *System Programming*.

The next topic provides specific information to help you review non-local extension ranges, patterns, and routing on your system. This information is required for several of the troubleshooting procedures in this chapter.

## Reviewing the Non-Local Dial Plan and Routing

Some of the troubleshooting steps in this chapter require that you review the extension ranges programmed in the non-local dial plan and/or the routing for private network calls. Use one of the following three methods to do this:

- **System Form.** Check System Non-Local UDP Administration Form in the Installation Specification before proceeding. This form summarizes the extension ranges and routing for the patterns programmed in your system. For each route, the pool number, programmed digit manipulation, the Facility Restriction Level (FRL) value are listed, and the voice/data attribute is listed.
- **System Report.** To see a system print report of existing non-local extension ranges, patterns, and routes, select the Print option on the System Programming menu and then choose NonLc1 UDP. Appendix B, "Network Reports," includes a sample.
- **System Programming.** To check the current call routing on a system, consult "UDP Routing" in Chapter 4 of *System Programming*. Alternatively, follow one of the summary procedures listed below, starting from the System Programming menu on your console or PC.

Console Procedure Tables→UDP Routing→Press **Inspect** to view current patterns in use→Exit→Dial the number of the pattern that you want to review→Enter→Press **Inspect** to view the current routing for the pattern→Exit→to view prepended digits, dial route number→Enter→Digits→view current digits→Exit→Exit→Exit→Exit→Exit→Exit

PC Procedure F8 → F7 → Press PgDn to view current patterns in use → F5 → Enter the number of the pattern that you want to review → F10 → Press PgDn to view the current routing for the pattern → F5 → to view the prepended digits dial the route number → F10 → F3 → view current digits → F5 → F5 → F5 → F5 → F5

## Verifying Switch Identifiers

For communications between switches to operate properly, the switch identifiers must be properly set:

- The switch identifier must be appropriate for a MERLIN LEGEND or DEFINITY system.
- The switch identifier must be appropriate for near or far distance between connected systems.
- The switch identifier must be programmed on every tandem trunk

If the switch identifiers are not properly set, any or all of the following problems may occur:

- Automatic cycling not blocked
- ARS not working across systems (the switch can't identify tandem versus central office lines).
- Incorrect call signaling information sent for calls to the VMS/AA (exact results depend on the VMS used).
- Incorrect SMDR reports
- Message Waiting light updates not sent or received properly
- Other unidentified problems

To check the switch identifier on a system, consult "Switch Identifiers" in Chapter 5 of this guide. Alternatively, follow one of the summary procedures listed below, starting from the System Programming menu on your console or PC.

Console Procedure To check an identifier for one trunk:

LinesTrunks → **More** → UDP → SwNum-Single → Dial trunk no. → Enter → View switch no. → Exit → Exit → Exit → Exit → Exit

To check an identifier for a block of trunks:

LinesTrunks → **More** → UDP → SwNum-Block → Dial starting trunk in block → Enter → Dial ending trunk in block → Enter → View switch no. → Exit → Exit → Exit

PC Procedure

To check an identifier for one trunk:

**F4** → **PgUp** → **F10** → **F1** → Type trunk no. → **F10** → View switch no. → **F5** → **F5** → **F5**

To view identifiers for a block of trunks:

**F4** → **PgUp** → **F10** → **F2** → Type starting trunk in block → **F10** → Type ending trunk in block → **F10** → View switch no. → **F5** → **F5** → **F5**



## Call to a Non-Local Extension: Unexpected Busy Tone

---

This topic discusses unexpected busy tones that may be caused by system features. It applies not only to regular calls from one private network extension to another but also to remote access calls that are routed among private network systems. [“Call to Non-Local Extension: Silence or Fast Busy Tone” on page 6](#) outlines possible causes for a busy tone that relate either to system programming of facilities or to call routing.

As a first step, the caller should try using Callback. All available local routes for the call may be busy, and Automatic or Selective Callback allows the call to queue for the next available tandem trunk assigned to the Route 1 pool.

If a user is having trouble with the Callback feature, see [“Callback Does Not Work” on page 20](#).

If the wait time for an available local trunk is unacceptable, you may be able to change the local extension or barrier code FRL and/or route FRLs for the UDP pattern in order to make more routes available for the call.

If you want to make changes in FRLs for routes, speak with the coordinating system manager for your private network and consult the following resources:

- [“How Facility Restrictions Levels Work in a Network” on page 9](#) discusses FRL planning in detail.
- To change a UDP route FRL, see [“Uniform Dial Plan Routing” on page 25](#) or “UDP Routing” in Chapter 4 of *System Programming*.
- To change the extension FRL, see *System Programming*, Chapter 3, “Common Administrative Procedures.”
- To change the FRL assigned to a remote access barrier code, see “Remote Access” in *System Programming*, Chapter 4. Follow the guidelines in [“Remote Access Default Class-of-Restriction Settings” on page 6](#).



### SECURITY ALERT:

*FRLs, applied to ARS and UDP routes, default class-of-restrictions (COR) for all tie and/or all non-tie tandem trunks, extensions, and remote access barrier codes are particularly important for maintaining security in a private network. Before changing FRLs in your system, check with the coordinating system manager, who should understand the security implications for your local system and for the private network as a whole.*

Changing local FRLs may not work simply because the problem is not on the local system. In this case, see [“Call to Non-Local Extension: Silence or Fast Busy Tone” on page 6](#).

## Call to Non-Local Extension: Silence or Fast Busy Tone

---

The following are likely circumstances in which silence occurs when a call is attempted:

- A selected tie or analog facility between the caller or called extension is out of service. After four consecutive occurrences, this can be verified by checking for an outgoing analog facility hardware error such as 8410 (no outgoing seizure) or 840B (no loop current). Call your service provider to verify that the line is functioning.
- No Touch-Tone Receivers (TTRs) available at a remote system when using tie trunks. This can be verified by checking for the 0c03 error on the error log on the remote switches. If this error persists, contact your local service representative.
- Power was lost at a remote system connected via PRI tandem trunks. If power is lost then restored, the PRI channels become active and cause false ringing until the calls are answered or the circuit finishes resetting.

A fast busy tone can have one of several causes. Before investigating further, check the following possibilities:

- A technician may be performing maintenance on local tandem trunks or non-local tandem trunks included in the routes for the call.
- A power failure may have occurred at the destination system or at another networked system whose tandem trunks are included in routes for the call.
- Some of the problems described in this section can occur when a system manager makes a change in a networked system's local dial plan, non-local dial plan, switch identifier, or DS1 Switch Type setting. Ensure that your private network system forms are kept up to date and that changes are cleared with the coordinating system manager.

**Possible Cause 1:** *All programmed available routes for the call are busy.*

**What to do:** Note the extension number range(s) being called. Check that the pattern assigned to the range includes routes that include pools that have a sufficient number of trunks to handle the call volume.

- If you're not sure of the pattern number being used to route calls in your local system, see ["Reviewing the Non-Local Dial Plan and Routing" on page 3](#).
- To add different routes that can handle the call, consult the coordinating system manager and see ["Uniform Dial Plan Routing" on page 25](#) or "UDP Routing" in Chapter 4 of *System Programming*.
- If you do not have enough tandem trunks to handle intersystem calls, consider assigning pools of PSTN trunks to less preferred routes (3 and 4, for example). If you program such routes and they involve higher toll costs

than routes that specify tandem facilities, you may need to adjust extension and route FRLs in order to restrict access to them. Be sure that you discuss any changes with the coordinating system manager.

- If the routing is correct and enough routes are included in the pattern, but the problem persists, check if PRI lines are used. If they are, check the error log for D-channel inoperative and loss of signal alarms indicating lines are inoperative. If the D-channel inoperative alarm has occurred, check the CSU/DSU associated with the line for correct programming. If the loss at signal alarm has occurred, check for open cables, etc. If these conditions are not present, go to Possible Cause 3.

**Possible Cause 2:** *Callback Queuing is not used.*

**What to Do:** All available local routes for the call may be busy, and Automatic or Selective Callback allows the call to queue for the next available tandem trunk assigned to the Route 1 pool. As a first step, the caller should try using Callback.

If a user is having trouble with the Callback feature, see [“Callback Does Not Work” on page 20](#).

**Possible Cause 3:** *Not enough trunks are assigned to the pools for UDP routes.*

**What to Do:** To verify, check the error log for pool busy errors (such as 4c02, Pool Busy). Consult System Form 2c, System Numbering: Line/Trunk Jacks to determine the assignments. To see a report of pool assignments, select the Print option on the System Programming menu and then choose Trunk Info and General.

- If more trunks are available and need to be assigned, follow the procedure in “Trunks to Pools Assignment” in Chapter 4 of *System Programming* to assign more tandem trunks. All the tandem trunks in a pool must be of the same type (tie or PRI).
- If not enough trunks are available, consider adding more to your system.
- If there are sufficient trunks assigned but the problem persists, go to Possible Cause 4.

**Possible Cause 4:** Facilities are available but restricted and the caller is not able to access them.

**What to Do:** Verify that the extension’s FRL is higher than or equal to the UDP route FRL.

If you want to make changes in FRLs for routes, speak with the coordinating system manager for your private network and consult the following resources:

- [“How Facility Restrictions Levels Work in a Network” on page 9](#) discusses FRL planning in detail.
- To change a UDP route FRL, see [“Uniform Dial Plan Routing” on page 25](#) or “UDP Routing” in Chapter 4 of *System Programming*.

- To change the extension FRL, see *System Programming*, Chapter 3, “Common Administrative Procedures.”
- To change the FRL assigned to a remote access barrier code, see “Remote Access” in *System Programming*, Chapter 4. Follow the guidelines in [“Remote Access Default Class-of-Restriction Settings” on page 6](#).



### SECURITY ALERT:

*FRLs, applied to ARS and UDP routes, default CORs for all tie and/or all non-tie tandem trunks, extensions, and remote access barrier codes are particularly important for maintaining security in a private network. Before changing FRLs in your system, check with the coordinating system manager, who should understand the security implications for your local system and for the private network as a whole.*

Changing local FRLs may not work simply because the problem is not on the local system. In this case, go to Possible Cause 5.

**Possible Cause 5:** *The FRL for the default COR for non-tie trunks (PRI) on the remote system may be blocking tandem calls. The private network is an all PRI network.*

**What to Do:** Check with the coordinating system manager so that he or she can determine where the problem exists. This may involve more than one system, depending upon how your private network is set up. For example, a call might be routed across the private network in a fashion such as this:

Origin System A→System B→System C→Destination System D

In this configuration, the coordinating system manager must check routes and default COR attributes for Systems B and C.

- Check to make sure the calling restriction of the default COR is set to unrestricted. The factory setting is outward restricted, which blocks calls across the private network.
- Check that the routes voice/data capability is correct for the type of call being made. The factory setting is Both, which will support both voice and data calls.
- In each intervening system, compare the FRLs assigned to routes for the call with the default COR FRL. The route FRL must be equal to or lower than the default COR value or the call is blocked. The factory setting is 3.
- If FRL settings are not the cause, go to Possible Cause 6.

**Possible Cause 6:** *There may be a numbering conflict in the switch identifiers for the trunks that carry the call. Within a private network, switch identifiers should be unique and unambiguous. If they are not, calls may terminate prematurely or continue to route unexpectedly.*

**What to Do:** The coordinating system manager must check system planning Form Non-Local UDP Administration Form in the Installation Specification and review the switch identifiers for all systems over which calls travel to reach the destination extension(s). To review a report including the switch identifiers programmed on your local system, select the Print option on the System Programming menu and then choose Trunk Info and General.

- If the switch identifiers are not correct, the coordinating system manager must see that a change is made at one or more non-local systems where the conflict exists. To change the current switch identifiers at your local system, see [“Switch Identifiers” on page 19](#) or “UDP Facilities” in Chapter 4 of *System Programming*.
- If the switch identifiers are correct and the problem persists, do one of the following:
  - If the call is being routed over any tandem PRI facilities, go to Possible Cause 7.
  - If the call is being routed over tandem tie trunks only, call the Lucent Technologies Helpline at 1 800 628-2888; consultation charges may apply.

**Possible Cause 7:** *The Switch Type setting at both ends of a tandem PRI facility may match.*

**What to Do:** The coordinating system manager must check the programmed Switch Type settings at networked systems. Calls are not routed properly unless the Switch Type setting is correctly programmed at the systems on both ends of any tandem PRI facilities on the call route. If only MERLIN LEGEND Communications Systems are included in the routing, the switch types must not match in a single private network link. For example, if System A is connected to System B by tandem PRI trunks, System A can be set to a switch type LEGEND-PBX and System B can be LEGEND-Ntwk. It does not matter which system is assigned a given switch type as long as they are not the same.

If a DEFINITY ECS or DEFINITY ProLogix Solutions system has its Interface field set to Network, any MERLIN LEGEND Communications Systems connected to it by tandem PRI trunks must specify LEGEND-Ntwk. If the Interface field specifies User, the MERLIN LEGEND Communications System facilities must be programmed with the LEGEND-PBX setting.

- If the call is routed over a tandem PRI facility connected to your system, ensure that the system at the other end of the facility is programmed correctly to work with your own setting. Consult system Non-Local UDP Administration Form in the Installation Specification. To see a report including the switch type programmed for PRI facilities on your system,

select the Print option on the System Programming menu and then choose PRI Info. “[PRI Facilities Switch Type](#)” on page 23 provides summary instructions for determining the switch type programmed at your system and changing it if necessary. “Switch Type” in the Chapter 4 “PRI Facilities” section of *System Programming* gives full details.

- In Release 6.1 and later systems, the PRI Switch Type Test requests the system at the other end to verify that the correct PRI switch type is programmed. This test should be run only by Lucent Technologies technicians or authorized representatives.
- If the call is carried over other systems connected by tandem PRI facilities, the coordinating system manager must ensure that the settings are correct, as in this example of MERLIN LEGEND Communications Systems:

System A LEGEND-PBX→System B LEGEND-Ntwk→System C LEGEND-PBX

- If the switch type settings are correct and problem persists, do one of the following:
  - If the call is a data call, go to Possible Cause 8.
  - If the call is not a data call, call the Lucent Technologies Helpline at 1 800 628-2888; consultation charges may apply.

**Possible Cause 8:** *The FRL for the default COR for tie trunks (T1-emulated voice or data, or analog) on the remote system may be blocking tandem calls. The private network includes at least one analog tie trunk.*

**What to Do:** Check with the coordinating system manager so that he or she can determine where the problem exists. This may involve more than one system, depending upon how your private network is set up. For example, a call might be routed across the private network in a fashion such as this:

Origin System A→System B→System C→Destination System D

In this configuration, the coordinating system manager must check routes and default COR attributes for Systems B and C.

- Check to make sure the calling restriction of the default COR is set to unrestricted. The factory setting is outward restricted, which blocks calls across the private network.
- Check that the routes voice/data capability is correct for the type of call being made. The factory setting is Both. Routes need to be programmed for voice or data, but not both.

If the call is routed over the PSTN, check ARS routes including the default local and non-local routes to be sure that the setting is either voice or data, but not both.

- In each intervening system, compare the FRLs assigned to routes for the call with the default COR FRL. The route FRL must be equal to or lower than the default COR value or the call is blocked. The factory setting is 3.

- If FRL settings are not the cause, go to Possible Cause 9.

**Possible Cause 9:** *If the call is a 64-kbps data call, all routing facilities may not support this data speed.*

**What to Do:** Unless you are directly connected to the destination system, the coordinating system manager must check the routes for the call. To check the local routes, see [“Reviewing the Non-Local Dial Plan and Routing” on page 3](#). To change the routing in order to specify facilities that can handle the call, see [“Uniform Dial Plan Routing” on page 25](#) or “UDP Routing” in Chapter 4 of *System Programming*.

If the call is routed over any analog facilities (tie or loop-start, for example), or T1-emulated voice or data facilities, it cannot go through because they support less than 64 kbps. If the call is routed over PRI and/or BRI facilities, a speed of 64 kbps may be possible. If this is not the cause of the problem, call the Lucent Technologies Helpline at 1 800 628-2888; consultation charges may apply.

## Call to Non-Local Extension: Warble Tone (Error Tone)

---

There are several reasons why a call to a non-local extension receives warble tone. The first two possibilities are easy to check, because they all derive from the local system. The third possible cause only occurs when there are tandem PRI facilities included in the route for the call.

**Possible Cause 1:** *The extension number is omitted from the non-local dial plan.*

**What to do:** Check your system’s non-local dial plan to see whether the destination extension number is included in a programmed extension range. If it is not, you have solved the problem. If it is included, check all tandem switches to ensure that the extension is in their non-local dial plans. To add the extension to the non-local dial plan, consult the coordinating system manager and see [“Non-Local Dial Plan Numbering” on page 15](#) or “System Renumbering” in Chapter 3 of *System Programming*. If it is included in all programmed extension ranges, proceed to Possible Cause 2.

**Possible Cause 2:** *The remote system rejects the dialed number on an all PRI private network route.*

**What to do:** Check that the number that arrived is in the non-local dial plan. If the number is in the non-local dial plan, verify that it is a valid extension number for a station, adjunct, calling group, Listed Directory Number (LDN), Remote Access, Dial 0, or ARS.

**Possible Cause 3:** *The pattern does not have pools assigned to any routes.*

**What to do:** Verify that the correct pattern is assigned to the range. If the pattern is correct, assign the pools to the routes.

**Possible Cause 4:** *The FRL assigned to the extension may not permit the call on any of the routes included in the pattern for the call.*

**What to do:** Look at the system form for the caller's extension. Depending on the type of extension (analog multiline, MLX, digital or analog data, operator, and so on) the extension form varies. You can see a report that lists all extension FRLs by choosing the Print option on the System Programming menu, then selecting Ext Direct. You can see programmed route FRLs by choosing Non-Lc1 UDP from the same menu.

For the call to go through, the extension FRL must be equal to or greater than at least one of the route FRLs for the pattern that is programmed to reach the destination extension range.

- If it is appropriate to change the extension FRL, see "ARS Restriction Levels for Extensions" in Chapter 4 of *System Programming*.
- If you change one or more route FRLs, the modification may restrict or unrestrict calling from some private network extensions. Be sure to clear any changes with the coordinating system manager for the private network. If you decide to make this change, see "[Uniform Dial Plan Routing](#)" on [page 25](#) or "UDP Routing" in Chapter 4 of *System Programming*. For details about FRLs in private networks, see "[Facility Restriction Levels and Remote Access](#)" on [page 5](#).
- If a local extension or route FRL is not the problem, the coordinating system manager must determine the private network route for the call once it leaves your local system. If there is an intervening system between yours and the destination, proceed to Possible Cause 5.
- If there is no intervening system between yours and the destination, go to Possible Cause 5.

**Possible Cause 5:** *The FRL for the default COR for non-tie trunks (PRI) on the remote system may be blocking tandem calls. The private network is an all PRI network.*

**What to Do:** Check with the coordinating system manager so that he or she can determine where the problem exists. This may involve more than one system, depending upon how your private network is set up. For example, a call might be routed across the private network in a fashion such as this:

Origin System A→System B→System C→Destination System D

In this configuration, the coordinating system manager must check routes and default COR attributes for Systems B and C.



- Check to make sure the calling restriction of the default COR is set to unrestricted. The factory setting is outward restricted, which blocks calls across the private network.
- Check that the routes voice/data capability is correct for the type of call being made. The factory setting is Both, which will support both voice and data calls for PRI facilities.
- In each intervening system, compare the FRLs assigned to routes for the call with the default COR FRL. The route FRL must be equal to or lower than the default COR value or the call is blocked. The factory setting is 3.
- If FRL settings are not the cause, call the Lucent Technologies Helpline at 1 800 628-2888; consultation charges may apply.

## Calls to Non-Local Extensions: Unexpected Busy Tone

---

This topic discusses unexpected busy tones that may be caused by system features. It applies not only to regular calls from one private network extension to another but also to remote access calls that are routed among private network systems.

**Possible Cause:** *Intersystem callers may receive a busy tone that is unexpected because they know that the call recipient has coverage. However, in a private network non-local calls are treated as outside calls by the system. The non-local extension may not have coverage for outside calls turned on.*

**What to Do:** Depending upon how the non-local system is set up, try one of the following techniques in order to reach the extension:

- If the destination extension can be dialed directly via Direct Inward Dialing (DID) or PRI dial-plan routing, try calling the destination extension over public switched telephone private network trunks. If you receive the same busy tone, then the Coverage setting may be the problem. Call the system manager or receptionist at the non-local system and have them check the extension to ensure that coverage is correct and that the extension is functional.
- If you cannot dial the extension directly, use public switched telephone network facilities or the non-local dial plan in order to reach the operator for the non-local system. Have the operator transfer you to the extension. You should be able to leave a message for the extension user with voice mail or with the operator.

If neither of the above methods solves the problem, call the non-local system's system manager or the private network coordinating system manager and explain the situation.

## Call to Non-Local Extension Reaches Wrong Extension

---

**Possible Cause:** *If a call to a non-local extension connects to the wrong extension, one or more non-local dial plan extension ranges and/or routes may be incorrectly programmed. Non-local dial plan numbers must be unique and unambiguous or calls can be misrouted. Furthermore, digit absorption and prepending for the routes must be programmed correctly.*

**What to Do:** First, review the local routing for the call (see [“Reviewing the Non-Local Dial Plan and Routing”](#) on page 3). Then follow the steps below.

1. At your local system, ensure that routing for the destination extension specifies pools of trunks connecting to the correct adjacent system (if there is more than one). If digit prepending or absorption is needed, make sure that it is correctly programmed. If you find an error, you have solved the problem. If not, proceed to Step 2.
2. If you are directly connected to the system where the destination extension is located, go to Step 3. Otherwise, the coordinating system manager should repeat Step 1 for each system through which the call is routed until you reach the system where the destination extension is located.
3. Check with the system manager at the destination system or with the coordinating system manager to ensure that the extension number is in the local dial plan for that system.



**NOTE:**

The system does not permit programming of non-local extension ranges that conflict with extension numbers included in the local or non-local dial plan. However, conflicts can still arise due to digit prepending or absorption as a call is routed across the private network.

If this is not the problem, call the Lucent Technologies Helpline at 1 800 628-2888; consultation charges may apply.

## Call to Non-Local Extension: Message from CO

---

**Possible Cause:** *If someone calls a non-local extension and connects to a central office message announcing a misdialed number or some other problem, the call is routed over a PSTN trunk (PSTN facility pools rather than tandem trunk pools are sometimes assigned to secondary UDP routes such as Routes 3 or 4). Problems can occur when the programming for a PSTN route does not at least prepend the correct digits (as in 555, for a local access call, or 1555 for a toll access call prefixed before a 4-digit extension number) and possibly absorb digits as well, in order for the call to be directed properly.*

**What to Do:** Check the UDP range for the pattern to which the dialed extension is assigned. See [“Reviewing the Non-Local Dial Plan and Routing” on page 3](#) for instructions.

If there is no error in the local programming and there is an intervening system between yours and the system where the destination extension is located, speak with the coordinating system manager. The coordinating system manager should check the intervening system’s UDP tables for proper digit manipulation. He or she can determine whether the routing problem is on that system.

If this is not the problem, call the Lucent Technologies Helpline at 1 800 628-2888; consultation charges may apply.

## Transfer to Non-Local Extension Not Completed

---

There are several possible causes for an incomplete transfer. They are very easy to check.

- **Do Not Disturb.** Calls transferred to non-local extensions that have Do Not Disturb active, using tie tandem trunks, do not return and the caller hears busy. The exception is a transfer that is routed over PRI tandem trunk that is manually completed. In this case, the transfer returns as an incomplete transfer.
- **Transfer from PassageWay Telephony Services Client.** Transfers with consultation cannot be made from PassageWay Telephony Services clients to non-local extensions. The user must make such a transfer by using a telephone.



**NOTE:**

PassageWay Telephony Services clients cannot use an application to transfer calls across the private network. The user must make transfers manually using a telephone. If the transfer recipient is a PassageWay

Telephony Services client, only the transfer originator calling information is delivered to the extension, not information about the original caller.

- **PSTN Trunk Transfer.** The system permits trunk-to-trunk transfers of inside or outside calls to non-local extensions, regardless of whether system programming has prohibited trunk-to-trunk transfer. However, trunk-to-trunk transfer does not work under the following circumstances:
  - Trunk-to-trunk transfer is prohibited at the transferring extension and the call is an outside call being transferred to a local PSTN line/trunk.
  - The transfer originator is attempting to transfer an outside PSTN or private network call to or from a loop-start line that does not have reliable disconnect. All loop-start lines connected to networked systems must have reliable disconnect.

If the problem persists, call the Lucent Technologies Helpline at 1 800 628-2888; consultation charges may apply.

## Transfer Call to Non-Local Extension Does Not Return

---

**Possible Cause:** *If a transfer to a non-local extension cannot be completed (due to the extension being busy, for example), the transfer returns only when the call was transferred manually and routed over tandem PRI facilities. Calls are not returned under the following conditions:*

- The call is routed over tandem tie trunks or PSTN trunks that may be used for less preferred routes
- The system operator transfers the call using a DSS programmed for transfer with automatic completion over PRI tandem trunks.

**What to Do:** Review the routing for the call (see [“Reviewing the Non-Local Dial Plan and Routing” on page 3](#) for instructions), and check with the coordinating system manager if necessary. If the call is routed over any tandem tie trunks or over any PSTN facilities, or if an operator is using a DSS programmed for transfer for automatic completion over PRI trunks, you have solved the problem.

If the call is routed only over tandem PRI facilities, call the Lucent Technologies Helpline at 1 800 628-2888; consultation charges may apply.

## Conference: Cannot Add Call

---

Non-local extensions are treated as outside parties for the purpose of transfer. A non-local conference participant takes up one of the two outside calls permitted in a conference.

**NOTE:**

A PassageWay Telephony Services client cannot add a non-local extension to a conference. The user must add the conferee by using a telephone. If a conferee is dropped, the PassageWay Telephony Services client display does not so indicate. A PassageWay Telephony Services client, when added to a conference, only sees information about the conference originator, not about other conferees.

If this is not the problem, call the Lucent Technologies Helpline at 1 800 628-2888; consultation charges may apply.

## DID Calls Not Completed

---

There are several reasons why Direct Inward Dialing (DID) calls across a private network may not complete, either due to busy facilities or to faulty programming. The coordinating system manager may need to address the problem.

**Possible Cause 1:** *All programmed and available routes for the call are busy.*

**What to do:** This problem solves itself when traffic decreases. Only address the problem if it persists.

Note the extension number range for the DID destination. At the system where the call is received from the PSTN, check that the pattern assigned to the range includes sufficient different routes with pools (of tandem and/or PSTN facilities) to handle the call volume. This is accomplished by checking the error for errors 4C01 (Pool Empty), 4C02 (Pool Busy), or 4C03 (Pool Busy and/or Out-of-Service). If any of these error codes are present, check the pool index on the maintenance screen to determine if it matches the pool used to deliver the call. If it matches, check occurrence times and count. If the count is too high and the occurrences indicate the problem occurred within the duration of the occurrences, consider changing the routing of the call, pool sizes, or add trunks to the pool if empty.

- To add more routes that can handle the call, see [“Uniform Dial Plan Routing” on page 25](#) or “UDP Routing” in Chapter 4 of *System Programming*.
- If more trunks are available and need to be assigned, follow the procedure in “Trunks to Pools Assignment” in Chapter 4 of *System Programming* to assign more tandem trunks. All the tandem trunks in a pool must be of the same type (tie or PRI).

- If not enough trunks are available, consider adding more to the system.
- If there are sufficient trunks assigned and the problem persists, the cause of the problem may be at an intervening system between the one where the calls are received from the PSTN and the destination. Go to Possible Cause 2.
- If there are sufficient trunks and routes and there are no intervening systems between the one where the calls are received from the PSTN and the destination, contact the provider of the DID service. If this does not solve the problem, call the Lucent Technologies Helpline at 1 800 628-2888; consultation charges may apply.

**Possible Cause 2:** *The FRL for the default COR for all tie (T-1 emulated voice or data, or analog) or non-tie trunks (PRI) on the remote system may be blocking tandem calls.*

**What to Do:** Check with the coordinating system manager so that he or she can determine where the problem exists. This may involve more than one system, depending upon how your private network is set up. For example, a call might be routed across the private network in a fashion such as this:

Origin System A→System B→System C→Destination System D

In this configuration, the coordinating system manager must check routes and default COR attributes for Systems B and C.

- Check to make sure the calling restriction of the default COR is set to unrestricted. The factory setting is outward restricted, which blocks calls across the private network.
- Check that the routes voice/data capability is correct for the type of call being made. The factory setting is Both, which will support both voice and data calls.
- In each intervening system, compare the FRLs assigned to routes for the call with the default COR FRL. The route FRL must be equal to or lower than the default COR value or the call is blocked. The factory setting is 3.
- If FRL settings are not the cause, call the Lucent Technologies Helpline at 1 800 628-2888; consultation charges may apply.

## ARS Calls Are Blocked

---

Verify that switch identifiers have been assigned to both ends of all private network trunks. (Switch cannot identify tandem versus central office lines. ARS is blocked from central office lines.)

**Possible Cause 1:** *The switch identifiers for the trunks that carry the call may not be assigned or may be assigned incorrectly. Within a private network, switch identifiers should be assigned to both ends of the private network trunks and should be unique and unambiguous. If they are not, the switch cannot identify tandem versus central office lines. ARS is blocked from central office lines.*

**What to Do:** The coordinating system manager must check system planning Form Non-Local UDP Administration Form in the Installation Specification and review the switch identifiers for all systems over which calls travel to reach the destination extension(s). To review a report including the switch identifiers programmed on your local system, select the Print option on the System Programming menu and then choose Trunk Info and General.

- If the switch identifiers are not correct, the coordinating system manager must see that a change is made at one or more non-local systems where the conflict exists. To change the current switch identifiers at your local system, see ["Switch Identifiers" on page 19](#) or "UDP Facilities" in Chapter 4 of *System Programming*.
- If the switch identifiers are correct and the problem persists, go to Possible Cause 2.

**Possible Cause 2:** *When an ARS call is routed across the private network, it can be intercepted because the default COR FRL at a networked system is lower than the ARS route (or the UDP route if the system is sending the call to another networked system).*

**What to do:** Check Possible Cause 2 listed in ["DID Calls Not Completed" on page 17](#) of the previous section. If the FRLs are not the cause, go to Possible Cause 3.

**Possible Cause 3:** *A Disallowed List assigned to the default COR settings where the call is routed either to the PSTN or to another system in the private network may be blocking the call.*

**What to do:** Check the Disallowed List entries applied to default COR settings at systems where the call is routed either to the PSTN or to another system in the private network. Compare the entries to the dialed digits; If it is necessary to change the Disallowed List, see "Disallowed Lists" in Chapter 3 of *System Programming*. Check the ARS programming to verify that the remote machine's ARS code is being prepended.

If this does not solve the problem, call the Lucent Technologies Helpline at 1 800 628-2888; consultation charges may apply.

## Callback Does Not Work

---

Callback allows queueing for an available line/trunk connected to the local system. If a user attempts an ARS- or UDP-routed call and hears a busy signal or warble tone, the signal may be derived from a non-local system's tandem or PSTN facilities. If this is the case, Callback does not work. When all available routes on the local system are busy, a caller can use Callback to wait for an available facility in the Route 1 pool.

## Network Call Transmission Level (Volume) Too Low or Too High

---

When transmission levels are too high or too low, the coordinating system manager must investigate the cause.

**Possible Cause 1:** *Switch identifiers programmed incorrectly.*

**What to Do:** Refer to the table below as you examine the problem. It lists the rules for programming switch identifiers. At each system in a private network, each tandem trunk is programmed (individually or as part of a block of trunks) to indicate the type of system connected to the other end of the trunk as well as the distance between the connected systems.

- 1–20 = trunk connected to a MERLIN LEGEND Communications System that is more than 200 miles away
- 21–40 = trunk connected to a MERLIN LEGEND Communications System that is within 200 miles
- 41–50 = trunk connected to a system that is not a MERLIN LEGEND Communications System (for example, a DEFINITY ECS communications system) and is more than 200 miles away
- 51–60 = trunk connected to a system that is not a MERLIN LEGEND Communications System (for example, a DEFINITY ProLogix Solutions communications system) and is within 200 miles



**NOTE:**

DEFINITY ECS and DEFINITY ProLogix Solutions systems are beyond the scope of this guide. For information about how these systems identify tandem facilities, see the documentation for the applicable system.

Follow the steps below to check on the problem.

1. Check the routing for the call, and identify each system where the call is routed, including the system where the call originated or was received from the public switched telephone network. See [“Reviewing the Non-Local Dial Plan and Routing” on page 3](#) for instructions.



2. As necessary, note the switch identifier programmed on each system for the trunks that carry the calls. To review a report including the switch identifiers programmed on a system, select the Print option on the System Programming menu and then choose Trunk Info and General.
3. Look for switch identifiers that incorrectly specify the distance between systems or that specify the incorrect type of system. The diagram below shows how switch identifiers might be programmed at either end of tandem trunks in a hypothetical private network. A switch identifier is programmed to identify the system at the *opposite* end of the tandem trunk. In the example, all three switches are MERLIN LEGEND Communications Systems. On the facility that links Systems A and B, the system managers program identifiers to indicate that they are within 200 miles of one another. Next to the name of each system, is the switch identifier associated with that switch. The switch is programmed on the switches on the other end of the tandem trunk. Systems B and C are linked by trunks whose identifiers indicate distant systems.

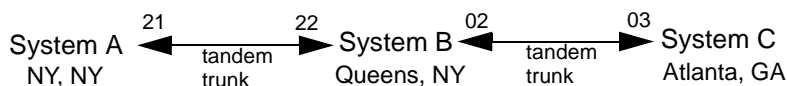

The example below shows programming that would be incorrect in the same private network. The link between Systems A and B has mismatched identifiers, because System B specifies that System A is more than 200 miles away. System C incorrectly specifies System B as a non-MERLIN LEGEND Communications System.

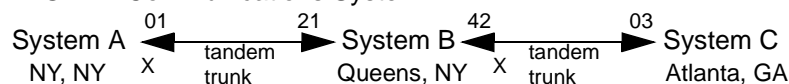

4. If any of the programming is incorrect, one or more system managers must correct it. The coordinating system manager must clear any changes. To change the switch identifiers at your local system, see [“Switch Identifiers” on page 19](#) or “UDP Facilities” in Chapter 4 of *System Programming*. If the programming appears to be correct, skip to Step 6.
5. Make some test calls across the private network. If calls are at the proper levels, the problem is solved. If transmission levels are still incorrect, proceed to Step 6.
6. If the identifiers appear correct but the distance between systems is between 180 and 220 miles, you may need to experiment with switch identifiers in order to achieve the correct transmission levels. Return to Step 4.

If changing one or more switch identifiers do not solve the problem,

**Possible Cause 2:** *More than three analog spans are involved in the call.*

**What to Do:** This may occur when calls are transferred or forwarded multiple times across analog facilities. Consider changing to digital facilities if this situation occurs frequently. Contact your Lucent Technologies representative or Local Authorized Dealer for instructions.

If the problem is not solved with the above instructions, call the Lucent Technologies Helpline at 1 800 628-2888; consultation charges may apply.

## MLX Displays: Network Call Display Problems

---

There are several possible causes for this problem, all of them easy to check:

**Possible Cause 1:** *Non-local extension calls and outside calls routed on tandem tie trunks display at recipient MLX display telephones as outside calls, for example, TIE-TRK.*

**What to Do:** Check the call routing and find out whether any tandem tie trunks are included in the route. You may need to contact the coordinating system manager. If the call originated from the PSTN on a PRI or BRI facility with Automatic Number Identification (ANI), the original calling party information displays when private network routing is over tandem PRI trunks only. Check the call routing and see whether any tandem tie trunks are included in the route.

**Possible Cause 2:** *Call transferred to the extension.*

**What to Do:** If the call was transferred to the extension, only the transfer originator information displays, not the name and/or number of the original caller, even if PRI ANI was available for the original call.

**Possible Cause 3:** *Display Preference setting for MLX incorrect*

**What to Do:** If the call route for an intersystem call includes only tandem PRI trunks and the call was not transferred, the Display Preference setting for the MLX display telephone extension may not be programmed as you expect. The factory setting displays the caller's extension number. Check System Planning Form, MLX Telephones, for the recipient extension or see ["Display Preferences for Intersystem Calls" on page 31](#) to check the setting through system programming. If you see the word "Ext" in the display, change the programming to Both.

You can see a report for the extension, showing the display preference, by choosing the Print option on the System Programming menu, then selecting Ext Info and entering the extension number. If the display shows a 10-digit ANI as PRI-TRK Ext 9089575555, you may want to change the display option from Name to Both and then the display would look like PRI-TRK 9089575555.

**Possible Cause 4:** *Transfer completed too quickly.*

**What to Do:** Callers must wait at least two seconds before completing transfers.

If none of these factors caused the problem, call the Lucent Technologies Helpline at 1 800 628-2888; consultation charges may apply.

## PassageWay Call Display Problems

---

In private networks, calls to and from PassageWay Telephony services clients may not display or initiate screen pop as expected. The operation varies according to the application, according to the following rules:

- For an outgoing call, if the PassageWay Telephony Services application uses the length of a destination telephone number to differentiate PSTN calls from UDP calls, a PassageWay Telephony Services client displays a non-local extension call in the same way as it does inside calls.
- For an outgoing call, if the PassageWay Telephony Services application uses receipt of the *Network Reached event* to differentiate PSTN calls from inside calls, a PassageWay Telephony Services client displays a non-local extension call or other UDP-routed call in the same way as it does an outside call made to the public switched telephone network.
- For an incoming call, if the PassageWay Telephony Services application uses the length of ANI information to differentiate PSTN calls from UDP calls, a PassageWay Telephony Services client displays a non-local dial plan call as an inside call.
- For an incoming call, if the PassageWay Telephony Services application uses the presence of a trunk identifier in the *delivered event* to differentiate PSTN calls from UDP calls, a PassageWay Telephony Services client displays a non-local dial plan call in the same way it does a PSTN call.
- For an incoming PSTN call that enters the private network on a PRI trunk with an ANI of length shorter than seven digits and crosses PRI tandem trunks only, the recipient PassageWay Telephony Services client display depends on the PassageWay Telephony Services application implementation.

If none of these factors explain the problem, contact the application provider. If the application provider instructs you to do so, call the Lucent Technologies Helpline at 1 800 628-2888; consultation charges may apply.

## ARS Calls Go to System Operator (Unassigned Extension)

---

**Possible Cause:** System managers in your private network may have set up ARS and remote access to route outgoing calls to PSTN facilities on switches where these calls are most economical.

**What to Do:** If such calls are reaching a system operator (unassigned extension) on a networked system, rather than being routed to the PSTN, the coordinating system manager must check the tandem facilities that carry calls to the system where the operator is located. The problem is caused when one or more tandem trunks has no switch identifier (the factory setting).

If this is not the problem, call the Lucent Technologies Helpline at 1 800 628-2888; consultation charges may apply.

## DID or PRI Dial-Plan Routed Calls Not Completed

---

**Possible Cause 1:** DID and PRI calls cannot be routed to a 5-digit DEFINITY ECS or DEFINITY ProLogix Solutions system.

**What to Do:** Verify system programming and the digits received from the PSTN. Refer to Chapter 5, "Non-Local Dial Plan Number" for details on programming required.

**Possible Cause 2:** DID or PRI routing not correct

**What to Do:** The coordinating system manager should check the DID or PRI routing. These calls may come into one networked switch and be routed across the private network to an extension on another system in the private network. The routing must specify the correct tandem trunk pools, extension numbers, and digit manipulation.

If the routing is correct, contact the service provider. If the service provider instructs you to do so, call the Lucent Technologies Helpline at 1 800 628-2888; consultation charges may apply.

## Excessive Line Noise on Voice and Data Calls

---

**Possible Cause:** *Clocks are not properly synchronized.*

**What to Do:** The coordinating system manager should check error logs at problem systems. If slips are occurring at a high rate or an alarm was raised, clock synchronization is a problem. The coordinating system manager should then check the programming for the PRI tandem trunk(s) and/or PSTN digital facilities that carry the calls. A single clock source is used for all networked systems so that calls are properly synchronized. For details about clock synchronization in a private network, see [“Clock Synchronization” on page 6](#). To program clock synchronization, see Chapter 4 of *System Programming*.

If the clock source is correct, ensure that the specified port is functioning properly and has an in-service facility connected to it.

If this does not solve or explain the problem, call the Lucent Technologies Helpline at 1 800 628-2888; consultation charges may apply.

## Station Message Detail Recording (SMDR) Reports Do Not Include Calls across the Network

---

In Release 6.0 systems, when SMDR is programmed to report both incoming and outgoing calls to an individual system, all UDP calls are also reported.

In Release 6.1 and later systems, SMDR can be programmed to log all UDP calls or to log no UDP calls. The SMDR option is programmed on individual private network systems and is not set network wide. If a UDP call is received or routed over a PSTN trunk, the call is recorded regardless of the setting for logging of UDP calls on each system involved on the call.

SMDR reports may report calls using more than one call record on more than one system. Depending upon how SMDR is programmed and how calls are routed, you may need to consult several SMDR records to trace a call that is routed over private network trunks.

For examples of SMDR reporting for calls routed across the private network, refer to “Station Message Detail Recording (SMDR) in Chapter 3 of this guide.

## Operator Hears Tones

---

**Possible Cause:** If the operator receives coverage calls intended for the VMS/AA because there were no ports available, the operator will hear the signalling information intended for the VMS/AA.

**What to Do:** Repair out of service ports or add more VMS ports as necessary so that overflow does not go to operator.

## Calls From a Remote System Do Not Reach the Centralized Voice Messaging System

---

The following are likely circumstances in which calls do not reach the centralized voice messaging system:

- System programming is incorrect. Some of the problems described in this section can occur when a system manager makes a change in a networked system's local dial plan, non-local dial plan, switch identifier, or DS1 Switch Type setting. Ensure that your private network system forms are kept up to date and that changes are cleared with the coordinating system manager. Refer to possible causes and action to take below.
- A selected tandem facility between the caller or called VMI extension is out of service. Check the error logs and if the error indicates an out of service condition, call the Lucent Technologies Helpline at 1 800 628-2888; consultation charges may apply.
- No Touch-Tone Receivers (TTRs) available at a remote system when using tie trunks. This can be verified by checking for the 0c03 error on the error log on the remote switches. If this error persists, contact your local service representative.
- A technician may be performing maintenance on tandem trunks included in the routes for the call.
- A power failure may have occurred at the destination system or at another networked system whose tandem trunks are included in routes for the call.

**Possible Cause 1:** Calling group used to route calls to the centralized VMS/AA is not programmed correctly or the coverage programming is not correct.

**What to Do:** Check the programming for the calling group:

- Verify that the calling group type is Integrated VMI.
- Verify that the calling group has a non-local member (VMI conversion number) assigned.

Check the coverage programming:

- For individual extensions that will receive coverage by the centralized VMS/AA, establish a coverage group verify that the extensions are assigned as senders in the group and the VMI calling group as the receiver.
- For calling groups that will receive overflow coverage to the centralized VMS/AA, verify that the VMI calling group is assigned as the calling group overflow receiver.

**Possible Cause 2:** *The routing for the VMI conversion number is not programmed correctly.*

**What to Do:** Check the programmed routing for the VMI conversion number:

- Verify the range for the VMI conversion number.
- Check the pattern assigned to the VMI conversion number and verify that the routes for the pattern are programmed as follows:
  - The private network facility pool contains a pool of PRI or tie trunks, but not mixed trunk types.
  - The FRL for the route is 0.
  - The digit absorption parameter is specified to absorb exactly the number of digits in the VMI conversion number. For example, if the VMI conversion number is 3738, 4 should be specified.
  - The other (prepended) Digits parameter is specified to add the extension number for the centralized VMS/AA calling group on the VMS hub. For example, if the extension at the VMS hub is 7700, specify prepending 7700.
  - The voice/data attribute is set to Voice.

**Possible Cause 3:** *All programmed available routes for the call are busy and/or out of service.*

**What to do:** Check that the pattern assigned to the VMI conversion number includes routes that include pools that have a sufficient number of trunks to handle the call volume and that all trunks are functioning properly.

- Check the error logs for out of service (such as 4c03, Pool Busy &/or OOS). Call your service provider if errors are present, and/or call the Lucent Technologies Helpline at 1 800 628-2888; consultation charges may apply
- If you're not sure of the pattern number being used to route calls in your local system, see ["Reviewing the Non-Local Dial Plan and Routing" on page 3](#).
- To add different routes that can handle the call, consult the coordinating system manager and see ["Uniform Dial Plan Routing" on page 25](#) or "Centralized Voice Message" in Chapter 4 of *System Programming*.

- If the routing is correct and enough routes are included in the pattern, but the problem persists, check if PRI lines are used. If they are, check the error log for D-channel inoperative and loss of signal alarms indicating lines are inoperative. If the D-channel inoperative alarm has occurred, check the CSU/DSU associated with the line for correct programming. If the loss at signal alarm has occurred, check for open cables, etc. If these conditions are not present, go to Possible Cause 4.

**Possible Cause 4:** *Not enough trunks are assigned to the pools for UDP routes.*

**What to Do:** Check the error log for no trunks in pool (such as 4c01, Pool empty). If error is present, consult System Form 2c, System Numbering: Line/Trunk Jacks to determine the assignments. To see a report of pool assignments, select the Print option on the System Programming menu and then choose Trunk Info and General.

- If more trunks are available and need to be assigned, follow the procedure in “Trunks to Pools Assignment” in Chapter 4 of *System Programming* to assign more tandem trunks. All the tandem trunks in a pool must be of the same type (tie or PRI).
- If not enough trunks are available, consider adding more to your system.
- If there are sufficient trunks assigned but the problem persists, go to Possible Cause 5.

**Possible Cause 5:** *No Touch-Tone Receivers (TTRs) available at remote system when using tie trunks.*

**What to Do:** This can be verified by checking for the 0C03 error on the error log on the remote switches.

- If this error persists, contact your local service representative.

**Possible Cause 6:** *The Switch Type setting at both ends of a tandem PRI facility may match.*

**What to Do:** The coordinating system manager must check the programmed Switch Type settings at networked systems. Calls are not routed properly unless the Switch Type setting is correctly programmed at the systems on both ends of any tandem PRI facilities on the call route. If only MERLIN LEGEND Communications Systems are included in the routing, the switch types must not match in a single private network link. For example, if System A is connected to System B by tandem PRI trunks, System A can be set to a switch type LEGEND-PBX and System B can be LEGEND-Ntwk. It does not matter which system is assigned a given switch type as long as they are not the same.

- If the call is routed over a tandem PRI facility connected to your system, ensure that the system at the other end of the facility is programmed correctly to work with your own setting. Consult system Non-Local UDP Administration Form in the Installation Specification. To see a report including the switch type programmed for PRI facilities on your system, select the Print option on the System Programming menu and then choose PRI Info. [“Tandem PRI Facilities” on page 22](#) provides summary



instructions for determining the switch type programmed at your system and changing it if necessary. "Switch Type" in the Chapter 4 "PRI Facilities" section of *System Programming* gives full details.

- In Release 6.1 and later systems, the PRI Switch Type Test requests the system at the other end to respond with information about the system mode specification. Lucent Technologies technicians or authorized representatives can run this test to determine the mode of the system at the other end.
- If the call is carried over other systems connected by tandem PRI facilities, the coordinating system manager must ensure that the settings are correct, as in this example of MERLIN LEGEND Communications Systems:

System A LEGEND-PBX→System B LEGEND-Ntwk→System C LEGEND-PBX

- If the switch type settings are correct and problem persists, call the Lucent Technologies Helpline at 1 800 628-2888; consultation charges may apply.

## Calls From a Remote System to Centralized Voice Messaging System Get the Wrong Message or Go To Operator

---

The following are likely circumstances in which calls reach the centralized voice messaging system but receive the wrong message, for example, automated attendant instead of voice mail, or no message, or go to operator:

**Possible Cause 1:** *There may be a numbering conflict in the switch identifiers for the trunks that carry the call. Within a private network, switch identifiers should be unique and unambiguous. If they are not, calls may terminate prematurely or continue to route unexpectedly.*

**What to Do:** Dial the local VMI group. If the problem still occurs, the coordinating system manager must check system planning Form Non-Local UDP Administration Form in the Installation Specification and review the switch identifiers for all systems over which calls travel to reach the destination extension(s). To review a report including the switch identifiers programmed on your local system, select the Print option on the System Programming menu and then choose Trunk Info and General.

- If the switch identifiers are missing or not correct, the coordinating system manager must see that a change is made at one or more non-local systems where the conflict exists. To change the current switch identifiers at your local system, see ["Switch Identifiers" on page 19](#) or "UDP Facilities" in Chapter 4 of *System Programming*.

- If the switch identifiers are correct and the problem persists, do one of the following:
  - If the call is being routed over any tandem PRI facilities, go to Possible Cause 2.
  - If the call is being routed over tandem tie trunks, the call information sent to the centralized VMS/AA for both inside calls and outside calls indicates an outside calls.

**Possible Cause 2:** *System programming is not correct or tandem tie trunks are used to route the call.*

**What to Do:** The action you takes depends on how frequently the problem occurs:

- If the problem occurs for all calls, verify that the outgoing VMI calling group is programmed as Integrated VMI.
- If the problem occurs only on tandem tie-trunks, verify trunk type. The call information sent to the VMS for both Inside calls and outside calls indicates an inside call. Program the VMS message as necessary to provide a generic message for both inside and outside calls.
- If the problem occurs only on tandem PRI trunks, Verify that switch identifier is not zero. See procedure earlier in this chapter.
- If the problem occurs only at certain times, check the time zone for Night Service and make adjustments to VMS recordings as needed.

## **No Message Waiting Light Update**

---

The following are likely circumstances in which Message Waiting lights are not updated:

- The error log indicates that Message Waiting light update has been delayed more than one minute. Errors are 0C04 (Message Waiting light facility timeout) and 0C05 (Message Waiting light delivery delay).
- A selected tandem facility between the caller or called VMI extension is out of service. Check the error logs and if the error indicates an out of service condition, call the Lucent Technologies Helpline at 1 800 628-2888; consultation charges may apply.
- No Touch-Tone Receivers (TTRs) available at a remote system when using tie trunks. This can be verified by checking for the 0c03 error on the error log on the remote switches. If this error persists, contact your local service representative.
- A technician may be performing maintenance on local tandem trunks or non-local tandem trunks included in the routes for the call.
- A power failure may have occurred at the destination system or at another networked system whose tandem trunks are included in routes for the call.

- Some of the problems described in this section can occur when a system manager makes a change in a networked system's local dial plan, non-local dial plan, switch identifier, or DS1 Switch Type setting. Ensure that your private network system forms are kept up to date and that changes are cleared with the coordinating system manager.



**NOTE:**

If there is an alarm on the CPU board and Message Waiting light updates not delivered is the only obvious problem, check the possible causes in this section before calling the Lucent Technologies helpline.

**Possible Cause 1:** *The UDP at the VMI hub system for voice messaging subscribers is programmed incorrectly.*

**What to Do:** Check the programmed routing for the VMI conversion number:

- Verify the ranges for the non-local subscribers.
- Verify that the pattern for each range has routes assigned.
- Verify that each route has pools assigned with the same type of trunks in each pool.

**Possible Cause 2:** *All programmed available routes for the call are busy.*

**What to do:** Check that the pattern assigned to the VMI conversion number includes routes that include pools that have a sufficient number of trunks to handle the call volume.

- If you're not sure of the pattern number being used to route calls in your local system, see ["Reviewing the Non-Local Dial Plan and Routing" on page 3](#).
- To add different routes that can handle the call, consult the coordinating system manager and see ["Uniform Dial Plan Routing" on page 25](#) or "Centralized Voice Message" in Chapter 4 of *System Programming*.
- If the routing is correct and enough routes are included in the pattern, but the problem persists, check if PRI lines are used. If they are, check the error log for D-channel inoperative and loss of signal alarms indicating lines are inoperative. If the D-channel inoperative alarm has occurred, check the CSU/DSU associated with the line for correct programming. If the loss of signal alarm has occurred, check for open cables, etc. If these conditions are not present, go to Possible Cause 4.

**Possible Cause 3:** *Not enough trunks are assigned to the pools for UDP routes.*

**What to Do:** Consult System Form 2c, System Numbering: Line/Trunk Jacks to determine the assignments. To see a report of pool assignments, select the Print option on the System Programming menu and then choose Trunk Info and General.

- If more trunks are available and need to be assigned, follow the procedure in “Trunks to Pools Assignment” in Chapter 4 of *System Programming* to assign more tandem trunks. All the tandem trunks in a pool must be of the same type (tie or PRI).
- If not enough trunks are available, consider adding more to your system.
- If there are sufficient trunks assigned but the problem persists, go to Possible Cause 4.

**Possible Cause 4:** *No Touch-Tone Receivers (TTRs) available at the hub or at a remote system when using tie trunks to send message waiting light updates.*

**What to Do:** This can be verified by checking for the 0c03 error on the error log on the hub and on the remote switches. If this error persists on any switches in the private network, contact your local service representative.

# Customer Support Information



---

## Support Telephone Number

**In the USA only**, Lucent Technologies provides a toll-tree customer Helpline (1 800 628-2888) 24 hours a day. If you need assistance when installing, programming, or using your system, call the Helpline or your Lucent Technologies representative. Consultation charges may apply.

**Outside the USA**, if you need assistance when installing, programming, or using your system, contact your Lucent Technologies representative.

## Federal Communications Commission (FCC) Electromagnetic Interference Information

This equipment has been tested and found to comply with the limits for a Class A digital device, pursuant to Part 15 of the FCC Rules. These limits are designed to provide reasonable protection against harmful interference when the equipment is operated in a commercial environment. This equipment generates, uses, and can radiate radio frequency energy and, if not installed and used in accordance with the instruction manual, may cause harmful interference to radio communications. Operation of this equipment in a residential area is likely to cause harmful interference, in which case the user will be required to correct the interference at his or her own expense.

## Canadian Department of Communications (DOC) Interference Information

---

This digital apparatus does not exceed the Class A limits for radio noise emissions set out in the radio interference regulations of the Canadian Department of Communications.

Le Présent Appareil Numérique n'émet pas de bruits radioélectriques dépassant les limites applicables aux appareils numériques de la classe A prescrites dans le règlement sur le brouillage radioélectrique édicté par le ministère des Communications du Canada.

## FCC Notification and Repair Information

---

This equipment is registered with the FCC in accordance with Part 68 of its rules. In compliance with those rules, you are advised of the following:

- **Means of Connection.** Connection of this equipment to the telephone network shall be through a standard network interface jack, USOC RJ11C, RJ14C, RJ21X. Connection to E&M tie trunks requires a USOC RJ2GX. Connection to off-premises extensions requires a USOC RJ11C or RJ14C. Connection to 1.544-Mbps digital facilities must be through a USOC RJ48C or RJ48X. Connection to DID requires a USOC RJ11C, RJ14C, or RJ21X. These USOCs must be ordered from your telephone company. Connection to 56-Kbps or 64-Kbps facilities requires a USOC RJ11C, RJ14C, or RJ21.
- **Party Lines and Coin Telephones.** This equipment may not be used with party lines or coin telephone lines.
- **Notification to the Telephone Companies.** Before connecting this equipment, you or your equipment supplier must notify your local telephone company's business office of the following:
  - The telephone number(s) you will be using with this equipment.
    - The appropriate registration number and ringer equivalence number (REN), which can be found on the back or bottom of the control unit, as follows:
    - If this equipment is to be used as a Key system, report the number AS593M-72914-KF-E.
    - If the system provides both manual and automatic selection of incoming/outgoing access to the network, report the number AS593M-72682-MF-E.
    - If there are no directly terminated trunks, or if the only directly terminated facilities are personal lines, report the number AS5USA-65646-PF-E.

- The REN (Ringer Equivalence Number) for all three systems is 1.5A.
- The facility interface code (FIC) and service order code (SOC):
  - For tie line connection, the FIC is TL31M and the SOC is 9.0F.
  - For connection to off-premises stations, the FIC is OL13C and the SOC is 9.0F.
  - For equipment to be connected to DID facilities, the FIC is 02RV2-T and the SOC is AS.2.
    - For equipment to be connected to 1.544-Mbps digital service, the SOC is 6.0P and the FIC is:
      - 04DU9-BN for D4 framing format with AMI zero code suppression.
      - 04DU9-DN for D4 framing format with bipolar 8 zero code suppression (B8ZS).04DU9-IKN for extended superframe format (ESF) with AMI zero code suppression.
      - 04DU9-ISN with ESF and B8ZS.
  - For equipment to be connected to 56-Kbps or 64-Kbps digital facilities, the FIC is 02B1Q.
- The quantities and USOC numbers of the jacks required.
- For each jack, the sequence in which lines are to be connected, the line types, the FIC, and the REN by position when applicable.
- **Ringer Equivalence Number (REN).** The REN is used to determine the number of devices that may be connected to the telephone line. Excessive RENs on the line may result in the devices not ringing in response to an incoming call. In most, but not all, areas the sum of the RENs should not exceed five (5.0). To be certain of the number of devices that may be connected to the line, as determined by the total RENs, contact the local telephone company to determine the maximum REN for the calling area.
- **Disconnection.** You must also notify your local telephone company if and when this equipment is permanently disconnected from the line(s).

## Installation and Operational Procedures

---

The manuals for your system contain information about installation and operational procedures.

- **Repair Instructions.** If you experience trouble because your equipment is malfunctioning, the FCC requires that the equipment not be used and that it be disconnected from the network until the problem has been corrected. Repairs to this equipment can be made only by the manufacturers, their authorized agents, or others who may be authorized by the FCC. In the event repairs are needed on this equipment, contact your authorized Lucent Technologies dealer or, **in the USA only**, contact the National Service Assistance Center (NSAC) at 1 800 628-2888.
- **Rights of the Local Telephone Company.** If this equipment causes harm to the telephone network, the local telephone company may discontinue your service temporarily. If possible, they will notify you in advance. But if advance notice is not practical, you will be notified as soon as possible. You will also be informed of your right to file a complaint with the FCC.
- **Changes at Local Telephone Company.** Your local telephone company may make changes in its facilities, equipment, operations, or procedures that affect the proper functioning of this equipment. If they do, you will be notified in advance to give you an opportunity to maintain uninterrupted telephone service.
- **Hearing Aid Compatibility.** The custom telephone sets for this system are compatible with inductively coupled hearing aids as prescribed by the FCC.
- **Automatic Dialers.** WHEN PROGRAMMING EMERGENCY NUMBERS AND/OR MAKING TEST CALLS TO EMERGENCY NUMBERS:
  - Remain on the line and briefly explain to the dispatcher the reason for the call.
  - Perform such activities in off-peak hours, such as early morning or late evening.
- **Direct Inward Dialing (DID).** This equipment returns answer supervision signals to the Public Switched Telephone Network when:
  - Answered by the called station
  - Answered by the attendant
  - Routed to a recorded announcement that can be administered by the customer premises equipment user
  - Routed to a dial prompt



This equipment returns answer supervision on all DID calls forwarded back to the Public Switched Telephone Network. Permissible exceptions are when:

- A call is unanswered
- A busy tone is received
- A reorder tone is received

*Allowing this equipment to be operated in such a manner as not to provide proper answer supervision signaling is in violation of Part 68 rules.*

**New Network Area and Exchange Codes.** The MERLIN LEGEND Communications System software does not restrict access to any new area codes or exchange codes established by a local telephone company. If the user has established toll restrictions on the system that could restrict access, then the user should check the lists of allowed and disallowed dial codes and modify them as needed.

**Equal Access Codes.** This equipment is capable of providing users access to interstate providers of operator services through the use of access codes. Modifications of this equipment by call aggregators to block access dialing codes is a violation of the Telephone Operator Consumers Act of 1990.

## DOC Notification and Repair Information

---

**NOTICE:** The Canadian Department of Communications (DOC) label identifies certified equipment. This certification means that the equipment meets certain telecommunications network protective, operational, and safety requirements. The DOC does not guarantee the equipment will operate to the user's satisfaction.

Before installing this equipment, users should ensure that it is permissible to connect it to the facilities of the local telecommunications company. The equipment must also be installed using an acceptable method of connection. In some cases, the company's inside wiring for single-line individual service may be extended by means of a certified connector assembly (telephone extension cord). The customer should be aware that compliance with the above conditions may not prevent degradation of service in some situations.

Repairs to certified equipment should be made by an authorized Canadian maintenance facility designated by the supplier. Any repairs or alterations made by the user to this equipment, or any equipment malfunctions, may give the telecommunications company cause to request the user to disconnect the equipment.

Users should ensure for their own protection that the electrical ground connections of the power utility, telephone lines, and internal metallic water pipe

system, if present, are connected. This precaution may be particularly important in rural areas.



**CAUTION:**

*Users should not attempt to make such connections themselves, but should contact the appropriate electrical inspection authority or electrician, as appropriate.*

To prevent overloading, the Load Number (LN) assigned to each terminal device denotes the percentage of the total load to be connected to a telephone loop used by the device. The termination on a loop may consist of any combination of devices subject only to the requirement that the total of the Load Numbers of all the devices does not exceed 100.

**DOC Certification No.:** 230 4095A

**CSA Certification No.:** LR 56260

**Load No.:** 6

## Renseignements sur la notification du ministère des Communications du Canada et la réparation

---

**AVIS:** L'étiquette du ministère des Communications du Canada identifie le matériel homologué. Cette étiquette certifie que le matériel est conforme à certaines normes de protection, d'exploitation et de sécurité des réseaux de télécommunications. Le Ministère n'assure toutefois pas que le matériel fonctionnera à la satisfaction de l'utilisateur.

Avant d'installer ce matériel, l'utilisateur doit s'assurer qu'il est permis de le raccorder aux installations de l'entreprise locale de télécommunication. Le matériel doit également être installé en suivant une méthode acceptée de raccordement. Dans certains cas, les fils intérieurs de l'entreprise utilisés pour un service individuel à ligne unique peuvent être prolongés au moyen d'un dispositif homologué de raccordement (cordon prolongateur téléphonique interne). L'abonné ne doit pas oublier qu'il est possible que la conformité aux conditions énoncées ci-dessus n'empêchent pas la dégradation du service dans certaines situations. Actuellement, les entreprises de télécommunication ne permettent pas que l'on raccorde leur matériel à des jacks d'abonné, sauf dans les cas précis prévus par les tarifs particuliers de ces entreprises.

Les réparations de matériel homologué doivent être effectuées par un centre d'entretien canadien autorisé désigné par le fournisseur. La compagnie de télécommunications peut demander à l'utilisateur de débrancher un appareil à la suite de réparations ou de modifications effectuées par l'utilisateur ou à cause de mauvais fonctionnement.

Pour sa propre protection, l'utilisateur doit s'assurer que tous les fils de mise à la terre de la source d'énergie électrique, des lignes téléphoniques et des

canalisations d'eau métalliques, s'il y en a, sont raccordés ensemble. Cette précaution est particulièrement importante dans les régions rurales.

**AVERTISSEMENT:** L'utilisateur ne doit pas tenter de faire ces raccordements lui-même; il doit avoir recours à un service d'inspection des installations électriques, ou à un électricien, selon le cas.



L'indice de charge (IC) assigné à chaque dispositif terminal indique, pour éviter toute surcharge, le pourcentage de la charge totale qui peut être raccordée à un circuit téléphonique bouclé utilisé par ce dispositif. La terminaison du circuit bouclé peut être constituée de n'importe quelle combinaison de dispositifs, pourvu que la somme des indices de charge de l'ensemble des dispositifs ne dépasse pas 100.

**No d'homologation:** 230 4095A

**No de certification:** CSA LR 56260

**L'indice de charge:** 6

MERLIN LEGEND D.O.C.  
Location Label Placement  
Ministère des Communications  
du Canada emplacement de  
l'étiquette

	<b>MERLIN LEGEND</b>	This device complies with Part 15 of the FCC Rules. Operation is subject to the following two conditions: (1) this device may not cause harmful interference, and (2) this device must accept any interference received, including interference that may cause undesired operation.
<b>Model 511A Control Unit</b>		Complies with Part 68, FCC Rules. See the SystemReference Manual for proper FCC Classification.
 LISTED 538E	TELEPHONE EQUIPMENT	FCC Reg. Nos. MF: AS593M-72682-MF-E KF: AS593M-72914-KF-E PF: AS5USA-65646-PF-E REN: 1.5A
MADE IN U.S.A.	 LR 56260	

Use only Lucent Technologies manufactured MERLIN LEGEND circuit modules, carrier assemblies, and power units, as specified in the Installation Manual, in this product. There are no user serviceable parts inside. Contact your authorized agent for service and repair.

This digital apparatus does not exceed the Class A limits for radio noise emissions set out in the radio interference regulations of the Canadian Department of Communications.

Le présent appareil numérique n'émet pas de bruits radioélectriques dépassant les limites applicables aux appareils numériques de la classe A prescrites dans le Règlement sur le brouillage radioélectrique édicté par le ministère Communications du Canada.

**WARNING:** If equipment is used for out-of-building applications, approved secondary protectors are required. See Installation Manual.

**AVERTISSEMENT:** Si l'équipement est utilisé pour des applications extérieures, l'installation d'un protecteur secondaire est requise. Voir le manuel d'Installation.

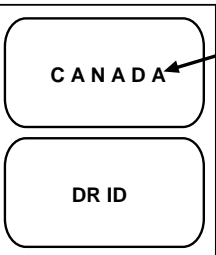

## Security of Your System: Preventing Toll Fraud

---

As a customer of a new telephone system, you should be aware that there is an increasing problem of telephone toll fraud. Telephone toll fraud can occur in many forms, despite the numerous efforts of telephone companies and telephone equipment manufacturers to control it. Some individuals use electronic devices to prevent or falsify records of these calls. Others charge calls to someone else's number by illegally using lost or stolen calling cards, billing innocent parties, clipping on to someone else's line, and breaking into someone else's telephone equipment physically or electronically. In certain instances, unauthorized individuals make connections to the telephone network through the use of the Remote Access features of your system.

The Remote Access features of your system, if you choose to use them, permit off-premises callers to access the system from a remote telephone by using a telephone number with or without a barrier code. The system returns an acknowledgment signaling the user to key in his or her barrier code, which is selected and administered by the system manager. After the barrier code is accepted, the system returns dial tone to the user. In Release 3.1 and later systems, barrier codes are by default restricted from making outside calls. In prior releases, if you do not program specific outward calling restrictions, the user is able to place any call normally dialed from a telephone associated with the system. Such an off-premises network call is originated at, and will be billed from, the system location.

The Remote Access feature, as designed, helps the customer, through proper administration, to minimize the ability of unauthorized persons to gain access to the network. Most commonly, phone numbers and codes are compromised when overheard in a public location, through theft of a wallet or purse containing access information, or through carelessness (for example, writing codes on a piece of paper and improperly discarding it). Additionally, hackers may use a computer to dial an access code and then publish the information to other hackers. Enormous charges can be run up quickly. It is the customer's responsibility to take the appropriate steps to properly implement the features, evaluate and administer the various restriction levels, protect access codes, and distribute access codes only to individuals who have been fully advised of the sensitive nature of the access information.

Common carriers are required by law to collect their tariffed charges. While these charges are fraudulent charges made by persons with criminal intent, applicable tariffs state that the customer of record is responsible for payment of all long-distance or other network charges. Lucent Technologies cannot be responsible for such charges and will not make any allowance or give any credit for charges that result from unauthorized access.

To minimize the risk of unauthorized access to your communications system:

- Use an unpublished Remote Access number.
- Assign access codes randomly to users on a need-to-have basis, keeping a log of *all* authorized users and assigning one code to one person.
- Use random-sequence access codes, which are less likely to be easily broken.
- Use the longest-length access codes the system will allow.
- Deactivate all unassigned codes promptly.
- Ensure that Remote Access users are aware of their responsibility to keep the telephone number and any access codes secure.
- When possible, restrict the off-network capability of off-premises callers, using calling restrictions, Facility Restriction Levels (FRLs) (Hybrid/PBX mode only), and Disallowed List capabilities. In Release 3.1 and later systems, a prepared Disallowed List (number 7) is provided and is designed to prevent the types of calls that toll-fraud abusers often make.
- When possible, block out-of-hours calling.
- Frequently monitor system call detail reports for quicker detection of any unauthorized or abnormal calling patterns.
- Limit Remote Call Forwarding to persons on a need-to-have basis.
- Change access codes every 90 days.
- Use the longest-length barrier codes possible, following the guidelines for passwords. (See "Choosing Passwords.")

## **Toll Fraud Prevention**

---

Toll fraud is the unauthorized use of your telecommunications system by third parties to make long-distance telephone calls. Under the law, you, the customer, are responsible for paying part or all of those unauthorized calls. Thus, the following information is of critical importance.

Unauthorized persons concentrate their activities in two areas with the MERLIN LEGEND Communications System:

- They try to transfer out of the MERLIN LEGEND Communications System to gain access to an outgoing trunk and make long-distance calls.
- They try to locate unused or unprotected mailboxes and use them as drop-off points for their own messages.

The following is a discussion of how toll fraud is often perpetrated and ways to prevent unauthorized access that can lead to toll fraud.

## Physical Security, Social Engineering, and General Security Measures

---

Criminals called *hackers* may attempt to gain unauthorized access to your communications system and voice messaging system in order to use the system features. Hackers often attempt to trick employees into providing them with access to a network facility (line/trunk) or a network operator. This is referred to as social engineering. Hackers may pose as telephone company employees and employees of Lucent Technologies or your authorized dealer. Hackers will go through a company's trash to find directories, dialing instructions, and other information that will enable them to break into the system. The more knowledgeable they appear to be about the employee names, departments, telephone numbers, and the internal procedures of your company, the more likely it is that they will be able to trick an employee into helping them.

### Preventive Measures

Take the following preventive measures to limit the risk of unauthorized access by hackers:

- Provide good physical security for the room containing your telecommunications equipment and the room with administrative tools, records, and system manager information. These areas should be locked when not attended.
- Provide a secure trash disposal for all sensitive information, including telephone directories, call accounting records, or anything that may supply information about your communications system. This trash should be shredded.
- Educate employees that hackers may try to trick them into providing them with dial tone or dialing a number for them. All reports of trouble, requests for moving extensions, or any other administrative details associated with the MERLIN LEGEND Communications System should be handled by one person (the system manager) or within a specified department. Anyone claiming to be a telephone company representative should be referred to this person or department.
- No one outside of Lucent Technologies needs to use the MERLIN LEGEND Communications System to test facilities (lines/trunks). If a caller identifies him- or herself as a Lucent Technologies employee, the system manager should ask for a telephone number where the caller can be reached. The system manager should be able to recognize the number as a Lucent Technologies telephone number. *Before connecting the caller to the administrative port of the MERLIN LEGEND Communications System, the system manager should feel comfortable that a good reason to do so exists.* In any event, it is not advisable to give anyone access to network facilities or operators, or to dial a number at the request of the caller.
- Any time a call appears to be suspicious, call the Lucent Technologies BCS Fraud Intervention Center at 1 800 628-2888 (fraud intervention for System 25, PARTNER<sup>®</sup> and MERLIN systems).

- Customers should also take advantage of Lucent Technologies monitoring services and devices, such as the NetPROTECT<sup>SM</sup> family of fraud-detection services, CAS with HackerTracker<sup>®</sup>, and CAT Terminal with Watchdog. Call 1 800 638-7233 to get more information on these Lucent Technologies fraud detection services and products.

## Security Risks Associated with Transferring through Voice Messaging Systems

---

Toll fraud hackers try to dial into a voice mailbox and then execute a transfer by dialing \*T. The hacker then dials an access code (either 9 for Automatic Route Selection or a pooled facility code) followed by the appropriate digit string to either direct dial or access a network operator to complete the call.



### NOTE:

In Release 3.1 and later systems, all extensions are initially and by default restricted from dial access to pools. In order for an extension to use a pool to access an outside line/trunk, this restriction must be removed.

## Preventive Measures

Take the following preventive measures to limit the risk of unauthorized transfers by hackers:

- Outward restrict all MERLIN LEGEND Communications System voice mail port extension numbers. This denies access to facilities (lines/trunks). In Release 3.1 and later systems, voice mail ports are by default outward restricted.
- As an additional security step, network dialing for all extensions, including voice mail port extensions, should be processed through ARS using dial access code 9.



### SECURITY ALERT:

*The MERLIN LEGEND Communications System ships with ARS activated with all extensions set to FRL 3, allowing all international calling. **To prevent toll fraud**, ARS FRLs should be established using:*

- FRL 0 for restriction to internal dialing only
- FRL 2 for restriction to local network calling only
- FRL 3 for restriction to domestic long-distance (excluding area code 809 for the Dominican Republic as this is part of the North American Numbering Plan, unless 809 is required)
- FRL 4 for international calling



*In Release 3.1 and later systems, default local and default toll tables are factory-assigned an FRL of 2 and 3 respectively. This simplifies the task of restricting extensions: the FRL for an extension merely needs to be changed from the default of 3.*

*Each extension should be assigned the appropriate FRL to match its calling requirements. All voice mail port extensions not used for Outcalling should be assigned to FRL 0 (the default setting in Release 3.1 and later).*

- Deny access to pooled facility codes by removing pool dial-out codes 70, 890-899, or any others on your system.
- Create a Disallowed List or use the pre-prepared Disallowed List number 7 (Release 3.1 and later systems only) to disallow dialing 0, 11, 10, 1700, 1809, 1900, and 976 or 1(wildcard)976. In Release 3.1 and later systems, Disallowed List number 7 does not include 800 and 1800 and 411 and 1411, but Lucent Technologies recommends that you add them. **Assign all voice mail port extensions to this Disallowed List. Lucent Technologies recommends assigning Disallowed List number 7. This is an added layer of security, in case outward restriction is inadvertently removed.** (In Release 3.1 and later systems, voice messaging ports are assigned by default to Disallowed List number 7.)

If your system is part of a private network, assign Disallowed List 7 to Remote Access.

If Outcalling is required by voice messaging system extensions:

- Program an ARS FRL of 2 on voice mail port extension(s) used for Outcalling. This allows calls to use the default local ARS table that is defaulted to an FRL of 2 and any other ARS routes with an FRL of 2 or less.
- If 800 and 411 numbers are used, remove 1800, 800, 411, and 1411 from Disallowed List number 7.
- If Outcalling is allowed to long-distance numbers, build an Allowed List for the voice mail port extension(s) used for Outcalling. This list should contain the area code and the first three digits of the local exchange telephone numbers to be allowed.
- In a private network, if your switch is outcalling only to non-local network extensions, program the VMI ports with an FRL of 2.

Additional general security for voice messaging systems:

- Use a secure password for the General Mailboxes.
- The default administration mailbox, 9997, must be reassigned to the system manager's mailbox/extension number and securely password protected.

- All voice messaging system users must use secure passwords known only to the user.

## **Security Risks Associated with the Automated Attendant Feature of Voice Messaging Systems**

---

Two areas of toll fraud risk associated with the Automated Attendant feature of voice messaging systems are the following:

- Pooled facility (line/trunk) access codes are translated to a menu prompt to allow Remote Access. If a hacker finds this prompt, the hacker has immediate access. (In Release 3.1 and later systems, dial access to pools is initially factory-set to restrict all extensions: to allow pool access, this restriction must be removed by the system manager.)
- If the Automated Attendant prompts callers to use Remote Call Forwarding to reach an outside telephone number, the system may be susceptible to toll fraud. An example of this application is a menu or Submenu that says, "To reach our answering service, select prompt number 5," and transfers a caller to an external telephone number.

Remote Call Forwarding can be used securely only when the central office provides "reliable disconnect" (sometimes referred to as forward disconnect or disconnect supervision), which guarantees that the central office does not return a dial tone after the called party hangs up. In most cases, the central office facility is a loop-start line/trunk which does not provide reliable disconnect. When loop-start lines/trunks are used, if the calling party stays on the line, the central office does return a dial tone at the conclusion of the call, enabling the caller to place another call as if it were being placed from your company. Ground-start trunks provide reliable disconnect and should be used whenever possible.

## **Preventive Measures**

Take the following preventive measures to limit the risk of unauthorized use of the Automated Attendant feature by hackers:

- *Do not* use Automated Attendant prompts for ARS Codes or Pooled Facility Codes.
- Assign all unused Automated Attendant Selector Codes to zero, so that attempts to dial these are routed to the system attendant.
- If Remote Call Forwarding is required, MERLIN LEGEND Communications System owners should coordinate with their Lucent Technologies Account Team or authorized dealer to verify the type of central office facility used for RCF. If it is a ground-start line/trunk, or if it is a loop-start line/trunk and central office reliable disconnect can be ensured, then nothing else needs to be done.



**NOTE:**

In most cases these are loop-start lines/trunks without reliable disconnect. The local telephone company must be involved in order to change the facilities used for RCF to ground start lines/trunks. Usually a charge applies for this change. Also, hardware and software changes may be necessary in the MERLIN LEGEND Communications System. The *MERLIN MAIL* MERLIN and *MERLIN LEGEND MAIL* Automated Attendant feature merely accesses the RCF feature in the MERLIN LEGEND Communications System. Without these changes being made, this feature is highly susceptible to toll fraud. These same preventive measures must be taken if the RCF feature is active for MERLIN LEGEND Communications System extensions whether or not it is accessed by an Automated Attendant menu.

## Security Risks Associated with the Remote Access Feature

---

Remote Access allows the MERLIN LEGEND Communications System owner to access the system from a remote telephone and make an outgoing call or perform system administration, using the network facilities (lines/trunks) connected to the MERLIN LEGEND Communications System. Hackers, scanning the public switched network by randomly dialing numbers with war dialers (a device that randomly dials telephone numbers, including 800 numbers, until a modem or dial tone is obtained), can find this feature, which will return a dial tone to them. They can even employ war dialers to attempt to discover barrier codes.

## Preventive Measures

Take the following preventive measures to limit the risk of unauthorized use of the MERLIN LEGEND Communications System Remote Access feature by hackers:

- The Remote Access feature can be abused by criminal toll fraud hackers, if it is not properly administered. Therefore, this feature should not be used unless there is a strong business need.
- It is strongly recommended that customers invest in security adjuncts, which typically use one-time passcode algorithms. These security adjuncts discourage hackers. Since a secure use of the Remote Access feature generally offers savings over credit-card calling, the break-even period can make the investment in security adjuncts worthwhile.
- If a customer chooses to use the Remote Access feature without a security adjunct, then multiple barrier codes should be employed, with one per user if the system permits. The MERLIN LEGEND Communications System permits a maximum of 16 barrier codes.

- The maximum length should be used for each barrier code, and should be changed periodically. Barrier codes, like passwords, should consist of a random, hard-to-guess sequence of digits. While MERLIN LEGEND Communications System Release 3.0 permits a barrier code of up to 11 digits, systems prior to Release 3.0 permit barrier codes of up to only four digits.

If Remote Access is used, an upgrade to MERLIN LEGEND Communications System Release 3.0 is encouraged to take advantage of the longer barrier code.

## Other Security Hints

---

Make sure that the Automated Attendant Selector Codes do not permit outside line selection.

Following are a number of measures and guidelines that can help you ensure the security of your communications system and voice messaging system.

Multiple layers of security are always recommended to keep your system secure.

Refer to *Network Reference*, Chapter 4.

## Educating Users

---

Everyone in your company who uses the telephone system is responsible for system security. Users and attendants/operators need to be aware of how to recognize and react to potential hacker activity. Informed people are more likely to cooperate with security measures that often make the system less flexible and more difficult to use.

- Never program passwords or authorization codes onto Auto Dial buttons. Display telephones reveal the programmed numbers and internal abusers can use the Auto Dial buttons to originate unauthorized calls.
- Discourage the practice of writing down barrier codes or passwords. If a barrier code or password needs to be written down, keep it in a secure place and never discard it while it is active.
- Operators or attendants should tell their system manager if they answer a series of calls where there is silence on the other end or the caller hangs up.
- Users who are assigned voice mailboxes should frequently change personal passwords and should not choose obvious passwords.
- The system manager should advise users with special telephone privileges (such as Remote Access, Outcalling, and Remote Call Forwarding) of the potential risks and responsibilities.

- Be suspicious of any caller who claims to be with the telephone company and wants to check an outside line. Ask for a callback number, hang up and confirm the caller's identity.
- Never distribute the office telephone directory to anyone outside the company; be careful when discarding it (shred the directory).
- Never accept collect telephone calls.
- Never discuss your telephone system's numbering plan with anyone outside the company.

## Educating Operators

---

Operators or attendants need to be especially aware of how to recognize and react to potential hacker activity. To defend against toll fraud, operators should follow the guidelines below:

- Establish procedures to counter *social engineering*. Social engineering is a con game that hackers frequently use to obtain information that may help them gain access to your communications system or voice messaging system.
- When callers ask for assistance in placing outside or long-distance calls, ask for a callback extension.
- Verify the source. Ask callers claiming to be maintenance or service personnel for a callback number. Never transfer to \*10 without this verification. Never transfer to extension 900.
- Remove the headset and/or handset when the console is not in use.

## Detecting Toll Fraud

---

To detect toll fraud, users and operators should look for the following:

- Lost voice mail messages, mailbox lockout, or altered greetings
- Inability to log into voice mail
- Inability to get an outside line
- Foreign language callers
- Frequent hang-ups
- Touch-tone sounds
- Caller or employee complaints that the lines are busy
- Increases in internal requests for assistance in making outbound calls (particularly international calls or requests for dial tone)
- Outsiders trying to obtain sensitive information
- Callers claiming to be the "phone" company
- Sudden increase in wrong numbers

## Establishing a Policy

---

As a safeguard against toll fraud, follow these guidelines for your MERLIN LEGEND Communications System and voice messaging system:

- Change passwords frequently (at least quarterly). Changing passwords routinely on a specific date (such as the first of the month) helps users to remember to do so.
- Always use the longest-length password allowed.
- Establish well-controlled procedures for resetting passwords.
- Limit the number of invalid attempts to access a voice mailbox to five or less.
- Monitor access to the MERLIN LEGEND Communications System dial-up maintenance port. Change the access password regularly and issue it only to authorized personnel. Disconnect the maintenance port when not in use. (However, this eliminates Lucent Technologies' 24-hour maintenance surveillance capability and may result in additional maintenance costs.)
- Create a communications system management policy concerning employee turnover and include these suggestions:
  - Delete all unused voice mailboxes in the voice mail system.
  - If a terminated employee had Remote Access calling privileges and a personal authorization code, remove the authorization code immediately.
  - If barrier codes and/or authorization codes were shared by the terminated employee, these should be changed immediately.
- Regularly back up your MERLIN LEGEND Communications System files to ensure a timely recovery should it be required. Schedule regular, off-site backups.
- Keep the Remote Maintenance Device turned off when not in use by Lucent Technologies or your authorized dealer.
- Limit transfers to registered subscribers only.
- Use the Security Violations Notification options (Mailbox Lock or Warning Message) to alert you of any mailbox break-in attempts. Investigate all incidents.
- Review security policies and procedures and keep them up to date.

## Choosing Passwords

---

Passwords should be the maximum length allowed by the system.

Passwords should be hard to guess and should **not** contain:

- All the same numbers (for example, 1111, 666666)
- Sequential characters (for example 123456)
- Numbers that can be associated with you or your business, such as your name, birthday, business name, business address, telephone number, or social security number
- Words and commonly used names

Passwords should be changed regularly, at least on a quarterly basis. Recycling old passwords is not recommended. Never program passwords (or authorization codes or barrier codes) onto a speed dial button.

## Physical Security

---

You should always limit access to the system console (or attendant console) and supporting documentation. The following are some recommendations:

- Keep the system console and supporting documentation in an office that is secured with a changeable combination lock. Provide the combination only to those individuals having a real need to enter the office.
- Keep telephone wiring closets and equipment rooms locked.
- Keep telephone logs and printed reports in locations that only authorized personnel can enter.
- Design distributed reports so they do not reveal password or trunk access code information.
- Keep the voice messaging system Remote Maintenance Device turned off.

## Limiting Outcalling

---

When Outcalling is used to contact subscribers who are off-site, use the MERLIN LEGEND Communications System Allowed Lists and Disallowed Lists or ARS features to minimize toll fraud.

If the Outcalling feature will not be used, outward restrict all voice messaging system ports. If Outcalling will be used, ports not used for Outcalling should be Outward Restricted (for MERLIN MAIL Voice Messaging Systems, port 2 on a 2-port system, port 4 on a 4-port system, ports 5 and 6 on a 6-port system; for MERLIN LEGEND MAIL Voice Messaging Systems, port 7 of the system's module). Use Outward Restriction, Toll Restrictions, Allowed Lists, Disallowed Lists and Facility Restrictions Levels, as appropriate, to minimize the possibility of toll fraud.

## Limited Warranty and Limitation of Liability

---

Lucent Technologies warrants to you, the customer, that your MERLIN LEGEND Communications System will be in good working order on the date Lucent Technologies or its authorized reseller delivers or installs the system, whichever is later ("Warranty Date"). If you notify Lucent Technologies or its authorized reseller within one year of the Warranty Date that your system is not in good working order, Lucent Technologies will without charge to you repair or replace, at its option, the system components that are not in good working order. Repair or replacement parts may be new or refurbished and will be provided on an exchange basis. If Lucent Technologies determines that your system cannot be repaired or replaced, Lucent Technologies will remove the system and, at your option, refund the purchase price of your system, or apply the purchase price towards the purchase of another Lucent Technologies system.

If you purchased your system directly from Lucent Technologies, Lucent Technologies will perform warranty repair in accordance with the terms and conditions of the specific type of Lucent Technologies maintenance coverage you selected. If you purchased your system from an a Lucent Technologies-authorized reseller, contact your reseller for the details of the maintenance plan applicable to your system.

This Lucent Technologies limited warranty covers damage to the system caused by power surges, including power surges due to lightning.

The following will not be deemed to impair the good working order of the system, and Lucent Technologies will not be responsible under the limited warranty for damages resulting from:

- Failure to follow Lucent Technologies' installation, operation, or maintenance instructions
- Unauthorized system modification, movement, or alteration
- Unauthorized use of common carrier communications services accessed through the system
- Abuse, misuse, or negligent acts or omissions of the customer and persons under the customer's control
- Acts of third parties and acts of God

LUCENT TECHNOLOGIES' OBLIGATION TO REPAIR, REPLACE, OR REFUND AS SET FORTH ABOVE IS YOUR EXCLUSIVE REMEDY.

EXCEPT AS SPECIFICALLY SET FORTH ABOVE, LUCENT TECHNOLOGIES, ITS AFFILIATES, SUPPLIERS, AND AUTHORIZED RESELLERS MAKE NO WARRANTIES, EXPRESS OR IMPLIED, AND SPECIFICALLY DISCLAIM ANY WARRANTIES OF MERCHANTABILITY OR FITNESS FOR A PARTICULAR PURPOSE.



## Limitation of Liability

---

Except as provided below, the liability of Lucent Technologies and its affiliates and suppliers for any claims, losses, damages, or expenses from any cause whatsoever (including acts or omissions of third parties), regardless of the form of action, whether in contract, tort, or otherwise, shall not exceed the lesser of: (1) the direct damages proven; or (2) the repair cost, replacement cost, license fee, annual rental charge, or purchase price, as the case may be, of the equipment that gives rise to the claim. Except as provided below, Lucent Technologies and its affiliates and suppliers shall not be liable for any incidental, special, reliance, consequential, or indirect loss or damage incurred in connection with the equipment. As used in this paragraph, consequential damages include, but are not limited to, the following: lost profits, lost revenues, and losses arising out of unauthorized use (or charges for such use) of common carrier telecommunications services or facilities accessed through or connected to the equipment. For personal injury caused by Lucent Technologies's negligence, Lucent Technologies's liability shall be limited to proven damages to person. **No action or proceeding against Lucent Technologies or its affiliates or suppliers may be commenced more than twenty-four (24) months after the cause of action accrues.** THIS PARAGRAPH SHALL SURVIVE FAILURE OF AN EXCLUSIVE REMEDY.

## Remote Administration and Maintenance

---

The Remote Administration and Maintenance feature of your telecommunications system, if you choose to use it, permits users to change the system features and capabilities from a remote location.

The Remote Administration and Maintenance feature, through proper administration, can help you reduce the risk of unauthorized persons gaining access to the network. However, telephone numbers and access codes can be compromised when overheard in a public location, or lost through theft of a wallet or purse containing access information or through carelessness (for example, writing codes on a piece of paper and improperly discarding them). Additionally, hackers may use a computer to dial an access code and then publish the information to other hackers. Substantial charges can accumulate quickly. It is your responsibility to take appropriate steps to implement the features properly, evaluate and administer the various restriction levels, and protect and carefully distribute access codes.

Under applicable tariffs, you will be responsible for payment of toll charges. Lucent Technologies cannot be responsible for such charges and will not make any allowance or give any credit resulting from unauthorized access.

To reduce the risk of unauthorized access through Remote Administration and Maintenance, please observe the following procedures:

- The System Administration and Maintenance capability of a Hybrid/PBX or Key system is protected by a password.
  - Change the default password immediately.
  - Continue to change the password regularly.
  - Give the password only to people who need it and impress upon them the need to keep it secret.
  - If anyone who knows the password leaves the company, change the password immediately.
- If you have a special telephone line connected to your Hybrid/PBX or Key system for Remote Administration and Maintenance, you should do one of the following:
  - Unplug the line when it is not being used.
  - Install a switch in the line to turn it off when it is not being used.
  - Keep the Remote Administration and Maintenance telephone number secret. Give it only to people who need to know it, and impress upon them the need to keep it a secret. Do not write the telephone number on the Hybrid/PBX or Key system, the connecting equipment, or anywhere else in the system room.

If your Remote Administration and Maintenance feature requires that someone in your office transfer the caller to the Remote Administration and Maintenance extension, you should impress upon your employees the importance of transferring only authorized individuals to that extension.

## Sample Reports

# B

---

This appendix includes samples of the print reports generated by the communications system. It only includes samples of reports that include information about private network features or affect planning for private networks.

**Table B-1. Sample Report Pages**

---

<b>For...</b>	<b>See...</b>
Dial Plan Report	<a href="#">B-6</a>
Non-Local Dial Plan Report	<a href="#">B-9</a>
Tie Trunk Information Report	<a href="#">B-10</a>
DID Trunk Information Report	<a href="#">B-11</a>
General Trunk Information Report	<a href="#">B-12</a>
DS1 Information Report	<a href="#">B-13</a>
PRI Information Report	<a href="#">B-14</a>
Remote Access (DISA) Information Report	<a href="#">B-18</a>
Disallowed Lists Report	<a href="#">B-19</a>
Access to Disallowed Lists Report	<a href="#">B-19</a>
Automatic Route Selection Report	<a href="#">B-20</a>
Extension Directory Report	<a href="#">B-21</a>

*Continued on next page*

Table B-1. *Continued*

For...	See...
Extension Information Report	<a href="#">B-22</a>
Direct Group Calling Information Report	<a href="#">B-24</a> , <a href="#">B-25</a>
Error Log Report	<a href="#">B-26</a>
Switch 56 Data Information Report	<a href="#">B-27</a>

[Table B-2](#) lists all of the system reports and includes the print menu option used to print each report, the report name, and a brief description of each report. For samples of all reports, see the *Feature Reference*.

To access the menu options in [Table B-2](#), select the Print option on the System Programming menu.

Table B-2. System Reports

Menu Option	Report Name	Description
All		Prints each of the reports available on the Print menu, from SysSet-up to Error Log. <b>Note:</b> With All selected, four trunk information reports automatically print. See Trunk Info.
SysSet-up	System Information	Systemwide information such as return intervals, system mode, system programming port, slot assignments, and so on.
Dial Plan	Dial Plan	Extensions assigned to pools, paging zones, calling groups, lines or trunks, and stations (in the report); labels for lines/trunks and stations.
Labels	Label Information	Labels assigned to stations (extensions), Posted Messages, and names and telephone numbers in MLX-20L Personal Directory.
Trunk Info		Select to display four trunk options: Tie, DID, Loop/Ground, General.
TIE	TIE Trunk Information	Extensions assigned to and signaling attributes associated with Tie trunks.
DID	DID Trunk Information	Extensions assigned to and signaling attributes associated with DID trunks.
Loop/ Ground	GS/LS Trunk Information	Extensions assigned to, signaling attributes for ground- and loop-start lines/trunks.
General	General Trunk Information	All identified extensions and feature-related attributes of each extension.

*Continued on next page*

Table B-2. *Continued*

Menu Option	Report Name	Description
TL Info	DS1 information	Options (line, signal, and so on) assigned to T1 trunks or lines.
PRI Info	PRI Information	PRI trunks assigned to B-channel groups.
Remote Access	Remote Access (DISA) Information	Remote access dial code, class of restriction, barrier code information.
Oper Info	Operator Information	For each system operator position: logical ID, extension number, label, type (DLC or QCC). All general system operator options, such as backup position; call types and priorities.
AllowList	Allowed Lists	Telephone numbers included in Allowed Lists. Lists numbered 0-7; entries numbered 0-9.
AllowListTo	Access to Allowed Lists	Lists numbered 0-7. If the Allowed List is assigned to remote access users and barrier codes are used, barrier codes are numbered 0-16. If no barrier codes are used, 17 means list is assigned to tie-trunk users and 18 means list is assigned to non-tie-trunk users.
AllowListTo	Access to Allowed Lists	Lists are numbered 0-7. If the Allowed List is assigned to Remote Access users and barrier codes are used, the barrier codes are numbered 0-16. If no barrier codes are used, 17 means the Allowed List is assigned to tie-trunk users and 18 means the Allowed list is assigned to non-tie-trunk users.
DisallowLst	Disallowed Lists	Telephone numbers included in Disallowed Lists. Lists are numbered 0-7, and entries are numbered 0-9.
DisallowTo	Access to Disallowed Lists	Telephones to which Disallowed Lists are assigned. Lists are numbered 0-7. If the Disallowed List is assigned to Remote Access users and barrier codes are used, the barrier codes are numbered 0-16. If no barrier codes are used, 17 means the Disallowed List is assigned to tie-trunk users and 18 means the Disallowed List is assigned to non-tie-trunk users.
ARS	Automatic Route Selection	Access code; table types with area codes and exchanges; routes for subpatterns A and B, FRL, absorb digit, delete digit, Dial 0, and N11 tables.

*Continued on next page*

Table B-2. *Continued*

Menu Option	Report Name	Description
Ext Direct	Extension Directory	Slot/port addresses, extensions, labels and feature-related attributes. Column headings are printed on the first page only and are not carried over to subsequent pages. Column headings 4 through 10 (and 14 through 20) should be read vertically. That is: FACE (Forced Account Code Entry); HBIS (HFAI/BIS); RCFW (Remote Call Forward); MICD (Microphone Disable); SIG (Voice Signal); RSTR (Calling Restrictions); ARSR (ARS Restriction Level); ZBDT (2B Data Capability).
Sys Direct	System Directory	System Speed Dial number, label and telephone number in System Directory, and whether number should display.
Group Page	Group Paging	Extension number for each group and the extension number of each telephone assigned to the group.
Ext Info	Extension Information	For each specified station (extension), type of equipment connected, features assigned, ESS supervisor status, and features assigned to each button. On this report, MLX-16DP telephones are reported as MLX-28D. As of Release 5.0, MLX-5 and MLX-5D telephones are reported as 5-button telephone sets. In releases prior to Release 5.0, MLX-5 and MLX-5D telephones are reported as MLX-10 and MLX-10D telephones respectively.
GrpCoverage	Group Coverage Information	Extension number for each group and the extension number for each telephone assigned to the group. Information is printed only for calling groups with members and/or lines/trunks assigned.
GrpCalling	Direct Group Calling Information	Group calling options (hunt, type, message waiting, station, delay announcements, alarm thresholds, and so on), the extension number for each telephone assigned to the group, and the lines or trunks assigned to the group.
Night Service	Night Service Information	The operator, password required, time-of-day, and Emergency Allowed List extension numbers.

*Continued on next page*

Table B-2. *Continued*

Menu Option	Report Name	Description
NonLocal UDP	Non-Local Dial Plan	Ranges of extension numbers for non-local dial plan extensions connected to a networked external switch; pattern number associated with each range. For each pattern, shows Pool number, absorbed and prepended (other) digits, FRL, and call type (voice, data, or both).
Call Pickup	Group Call Pickup	Extension numbers for telephones assigned to each group; pickup groups numbered 1-30.
Error Log	Error Log	Error message and code, time and day error occurred, frequency of error. See the <i>Maintenance and Troubleshooting</i> guide.
Auth Code	Authorization Code Information	Authorization Code and permissions for extensions to which authorization codes are assigned.
BRI	BRI Information Report	Service Profile ID and Directory Number for each BRI line, flexible timers, and fixed timers and counters.
Switch 56	Switch 56 Data Information Report	Dial Plan Routing information and programmable options.

## Dial Plan Report

**Print Menu Option:** Dial Plan  
**Sections:** Pools; Telephone Paging Zones; Direct Group Calling Group; Lines/Trunks; Stations

### DIAL PLAN FOR POOLS

POOL.# 1: 70  
POOL.# 2: 890  
POOL.# 3: 891  
POOL.# 4: 892  
POOL.# 5: 893  
POOL.# 6: 894  
POOL.# 4: 895  
POOL.# 8: 896  
POOL.# 9: 897  
POOL.# 10: 898  
POOL.# 11: 899

### DIAL PLAN FOR TELEPHONE PAGING ZONES

TPZ # 1: 793  
TPZ # 2: 794  
TPZ # 3: 795  
TPZ # 4: 796  
TPZ # 5: 797  
TPZ # 6: 798  
TPZ # 7: 799

### DIAL PLAN FOR DIRECT GROUP CALLING GROUP

DGCG # 1: 770  
DGCG # 2: 771  
DGCG # 3: 772  
DGCG # 4: 773  
DGCG # 5: 774  
.  
.  
.  
DGCG # 32: 7929

### DIAL PLAN FOR LINES/TRUNKS

LINE # 1:	801	OUTSIDE	LINE # 2:	802	OUTSIDE
LINE # 3:	803	OUTSIDE	LINE # 4:	804	OUTSIDE
LINE # 5:	805	OUTSIDE	LINE # 6:	806	OUTSIDE
LINE # 7:	807	OUTSIDE	LINE # 8:	808	OUTSIDE
LINE # 9:	809	OUTSIDE	LINE # 10:	810	OUTSIDE
.			.		
.			.		
.			.		
LINE # 79:	879	OUTSIDE	LINE # 80:	880	OUTSIDE



## Dial Plan Report—Continued

### DIAL PLAN FOR STATIONS

STN #:	1	10	OPERATR	STN #:	2	710	
STN #:	3	11		STN #:	4	711	
STN #:	5	12		STN #:	6	712	
STN #:	7	13	EXT 13	STN #:	8	713	
STN #:	9	14	EXT 14	STN #:	10	714	
STN #:	11	15		STN #:	12	715	
STN #:	13	16		STN #:	14	716	
STN #:	15	17		STN #:	16	717	
STN #:	17	18	EXT 18	STN #:	18	19	
STN #:	19	20		STN #:	20	21	
STN #:	21	22	OPERATR	STN #:	22	23	
STN #:	23	24		STN #:	24	25	
STN #:	25	26		STN #:	26	21	
STN #:	27	28		STN #:	28	29	
STN #:	29	30	AUDIXVP	STN #:	30	31	AUDIXVP
STN #:	31	32	AUDIXVP	STN #:	32	33	AUDIXVP
STN #:	33	34		STN #:	34	35	
STN #:	35	36		STN #:	36	31	
STN #:	37	38		STN #:	38	39	
STN #:	39	40		STN #:	40	41	
STN #:	41	42	EXT 42	STN #:	42	742	
.				.			
.				.			
.				.			
STN #:	121	7198		STN #:	122	7398	
STN #:	123	5555		STN #:	124	7399	

## Dial Plan Report—Continued

COMPLETE DIAL PLAN FOR STATIONS AND ADJUNCTS

ID #:	1	4000	7300	ID #:	2	4001	7301
ID #:	3	4002	7302	ID #:	4	4003	7303
ID #:	5	4004	7304	ID #:	6	4005	7305
ID #:	7	4006	7306	ID #:	8	4007	7307
ID #:	9	4008	7308	ID #:	10	4009	7309
ID #:	11	4010	3000	ID #:	12	4011	3001
ID #:	13	4012	3002	ID #:	14	4013	3003
ID #:	15	4014	3004	ID #:	16	4015	3005
ID #:	17	4016	3006	ID #:	18	4017	3007
ID #:	19	4018	3008	ID #:	20	4019	3009
ID #:	21	4020	3010	ID #:	22	4021	3011
ID #:	23	4022	3012	ID #:	24	4023	3013
ID #:	25	4024	3014	ID #:	26	4025	3015
ID #:	27	4026	3016	ID #:	28	4027	3017
ID #:	29	4028	3018	ID #:	30	4029	3019
ID #:	31	4030	3020	ID #:	32	4031	3021
ID #:	33	4032	3022	ID #:	34	4033	3023
ID #:	35	4034	3024	ID #:	36	4035	3025
ID #:	37	4036	3026	ID #:	38	4037	3027
ID #:	39	4038	3028	ID #:	40	4039	3029
ID #:	41	4040	3030	ID #:	42	4041	3031
ID #:	43	4042	3032	ID #:	44	4043	3033
ID #:	45	4044	3034	ID #:	46	4045	3035
ID #:	47	4046	3036	ID #:	48	4047	3037
ID #:	49	4048	3038	ID #:	50	4049	3039
ID #:	51	4050	3040	ID #:	52	4051	7351
ID #:	53	4052	3042	ID #:	54	4053	7353
ID #:	55	4054	7354	ID #:	56	4055	7355
ID #:	57	4056	7356	ID #:	58	4057	7357
ID #:	59	4058	7358	ID #:	60	4059	7359
ID #:	61	7160	7360	ID #:	62	7161	7361
ID #:	63	7162	7362	ID #:	64	7163	7363
ID #:	65	7164	7364	ID #:	66	7165	7365
ID #:	67	7166	7366	ID #:	68	7167	7367
ID #:	69	7168	7368	ID #:	70	7169	7369
.				.			
.				.			
.				.			
ID #:	191	5151	7490	ID #:	192	5152	7491
ID #:	193	5153	7492	ID #:	194	5154	7493
ID #:	195	5155	7494	ID #:	196	5156	7495
ID #:	197	5156	7496	ID #:	198	5158	7497
ID #:	199	5158	7498	ID #:	200	5160	7499

## Non-Local Dial Plan Report

**Print Menu Option:** NonLc1 UDP (Release 6.0 and later systems only)  
**Sections:** Ranges; Patterns

	Range	Ptn	Dgt		Range	Ptn	Dgt		Range	Ptn	Dgt
01)	2400-2449	01	04	18)	5200-5200	11	04	35)	7590-7609	07	04
02)	2550-2559	02	04	19)	5201-5202	12	04	36)	7610-7709	08	04
03)	2560-2569	03	04	20)	5203-5204	13	04	37)	7710-7809	09	04
04)	2570-2589	04	04	21)	5205-5206	14	04	38)	7810-7899	10	04
05)	2590-2609	04	04	22)	5207-5209	15	04	39)	8050-8059	15	04
06)	2610-2649	05	04	23)	5210-5230	03	04	40)	8060-8069	03	04
07)	2650-2679	06	04	24)	5231-5250	17	04	41)	8070-8099	04	04
08)	3100-3109	07	04	25)	5251-5270	18	04	42)	8100-8199	05	04
09)	3110-3129	07	04	26)	6050-6079	14	04	43)	8200-8229	06	04
10)	3130-3159	02	04	27)	7000-7049	12	04	44)	8230-8259	16	04
11)	3160-3179	06	04	28)	7050-7050	20	04	45)	8260-8289	17	04
12)	3180-3199	08	04	29)	7051-7059	01	04	46)	8290-8389	18	04
13)	4000-4025	08	04	30)	7060-7099	02	04	47)	8390-8429	19	04
14)	5000-5049	09	04	31)	7100-7119	03	04	48)	8430-8459	20	04
15)	5050-5079	10	04	32)	7220-7449	04	04	49)	8460-8489	03	04
16)	5080-5099	01	04	33)	7450-7549	05	04	50)	8490-8499	02	04
17)	5100-5199	02	04	34)	7550-7589	06	04				

Pattern 01:

Pool	Absorb	Other Digits	FRL	Call type
1)3870	00	00	0	BOTH
2)3892	00	00	0	BOTH
3)3893	00	00	0	BOTH
4)3894	00	00	0	BOTH

Pattern 02:

Pool	Absorb	Other Digits	FRL	Call type
1)4590	00	00	2	BOTH
2)4592	00	00	2	Voice
3)3893	00	00	0	BOTH
4)3894	00	00	0	BOTH
.	.	.	.	.
.	.	.	.	.

Pattern 20:

Pool	Absorb	Other Digits	FRL	Call type
1)4591	00	00	3	Data
2)4592	00	00	3	Data
3)3894	00	00	3	BOTH
4)3870	00	00	4	BOTH

## Tie Trunk Information Report

---

Print Menu Option: Trunk Info and TIE

### TIE TRUNK INFORMATION

TRUNK	849	Slot/Port : 14/ 1	TIE-PBX
Direction:	2 Way	E&M Signal: Type1S	Dialtone : Remote
InType	: Delay	InMode : Rotary	AnsSupvr : 300 ms
OutType	: Delay	OutMode : Rotary	Disconnect: 300 ms

TRUNK	850	Slot/Port : 14/ 2	TIE-PBX
Direction:	2 Way	E&M Signal: Type1S	Dialtone : Remote
InType	: Delay	InMode : Rotary	AnsSupvr : 300 ms
OutType	: Delay	OutMode : Rotary	Disconnect: 300 ms

TRUNK	851	Slot/Port : 14/ 3	S56DATA
Direction:	2 Way	E&M Signal: Type1S	Dialtone : Remote
InType	: Delay	InMode : Rotary	AnsSupvr : 300 ms
OutType	: Delay	OutMode : Rotary	Disconnect: 300 ms

TRUNK	852	Slot/Part : 14/ 4	TIE-PBX
Direction:	2 Way	E&M Signal: Type1S	Dialtone : Remote
InType	: Delay	InMode : Rotary	AnsSupvr : 300 ms
OutType	: Delay	OutMode : Rotary	Disconnect: 300 ms

## DID Trunk Information Report

---

Print Menu Option: Trunk Info and DID

DID TRUNK INFORMATION

Trk	SS/PP	Blk	DiscTime	Type	ExpDig	DelDig	AddDig	Signal	InvDest
841	13/ 1	1	500ms	Wink	4	3	1	TouchTone	BkupExt
842	13/ 2	1	500ms	Wink	4	3	1	TouchTone	BkupExt
843	13/ 3	2	500ms	Wink	3	0		Rotary	BkupExt
844	13/ 4	2	500ms	Wink	3	0		Rotary	BkupExt
845	13/ 5	1	500ms	Wink	4	3	1	TouchTone	BkupExt
846	13/ 6	1	500ms	Wink	4	3	1	TouchTone	BkupExt
847	13/ 7	2	500ms	Wink	3	0		Rotary	BkupExt
848	13/ 8	1	500ms	Wink	4	3	1	TouchTone	BkupExt



## DS1 Information Report

---

Print Menu Option: T1 Info

DS1 SLOT ATTRIBUTES

Slot	Type	Format	Supp	Signal	LineComp	ClkSync	Src	Active
2	T1	ESF	B8ZS	Rob Bit	1	Prim	Loop	No
3	T1	ESF	B8ZS	Rob Bit	1	None	Local	No

## PRI Information Report

---

**Print Menu Option:** PRI Info  
**Sections:** Network Selection, Special Service, Call-by-Call and Dial Plan Routing Tables; PRI Information

Slot 5 Switch: DMS-100

Slot 11 Switch: Legend-PBX

Slot 12 Switch: Legend-PBX

System: By line

BchnlGrp #:	Slot:	TestTelNum:	NtwkServ:	Incoming Routing:
5	5		CallbyCall	By Dial Plan

Channel ID:	23	22	21	20	19	18	17	16	15	14
	13	12	11	10	9	8	7	6	5	4
	3	2	1							

Line	PhoneNumber	NumberToSend
801		
802		
803		
804		
805		
806		
807		
808		
809		
810		
811		
812		
813		
814		
815		
816		
817		
818		
819		
820		
821		
822		
823		



## PRI Information Report—Continued

---

BchnlGrp #: Slot: TestTelNum: NtwkServ: Incoming Routing:  
79 12 ElecTandNtwkRoute Directly to UDP

Channel ID: 1 2 3 4 5 6 7 8 9 10  
11 12 13 14 15 16 17 18 19 20  
21 22 23

Line	PhoneNumber	NumberToSend
849		
850		
851		
852		
853		
854		
855		
856		
857		
858		
859		
860		
861		
862		
863		
864		
865		
866		
867		
868		
869		
870		
871		

BchnlGrp #: Slot: TestTelNum: NtwkServ: Incoming Routing:  
80 11 ElecTandNtwk Route Directly to UDP

Channel ID: 1 2 3 4 5 6 7 8 9 10  
11 12 13 14 15 16 17 18 19 20  
21 22 23

Line	PhoneNumber	NumberToSend
825		
826		
827		
828		
829		

## PRI Information Report—Continued

830  
 831  
 832  
 833  
 834  
 835  
 836  
 837  
 838  
 839  
 840  
 841  
 842  
 843  
 844  
 845  
 846  
 847

### Network Selection Table

Entry Number:	0	1	2	3
Pattern to Match:	101****	10***		

### Special Service Table

Entry Number:	0	1	2	3	4	5	6	7
Pattern to Match:	011	010	01	00	0	1		
Operator:	none	OP	OP	OP/P	none	none	none	none
Type of Number:	I	I	I	N	N	N	N	N
Digits to Delete:	3	3	2	2	1	0	0	0

### Call-By-Call Service Table

Entry Number:	0	1	2	3	4
Pattern 0:	957	7			
Pattern 1:		1			
Pattern 2:		2			
Pattern 3:		3			
Pattern 4:		4			
Pattern 5:		5			
Pattern 6:		6			
Pattern 7:		7			
Pattern 8:		8			

## PRI Information Report—Continued

Pattern	9:	9			
Call Type:	BOTH	BOTH	BOTH	BOTH	BOTH
NtwkServ:	DMS-Private	DMS-Private			
DeleteDigits:	0	0	0	0	0
Entry Number:	5	6	7	8	9
Call Type:	BOTH	BOTH	BOTH	BOTH	BOTH
NtwkServ:					
DeleteDigits:	0	0	0	0	0

### Dial Plan Routing Table

Entry Number:	0	1	2	3
NtwkServ:	Any service	Any service	Any service	
Expected Digits:	4	7	10	0
Pattern to Match:				
Digits to Delete:	0	7	10	0
Digits to Add:		13	13	
Entry Number:	4	5	6	7
NtwkServ:				
Expected Digits:	0	0	0	0
Pattern to Match:				
Digits to Delete:	0	0	0	0
Digits to Add:				
Entry Number:	8	9	10	11
NtwkServ:				
Expected Digits:	0	0	0	0
Pattern to Match:				
Digits to Delete:	0	0	0	0
Digits to Add:				
Entry Number:	12	13	14	15
NtwkServ:				
Expected Digits:	0	0	0	0
Pattern to Match:				
Digits to Delete:	0	0	0	0
Digits to Add:				

## Remote Access (DISA) Information Report

---

**Print Menu Option:** Rmote Access  
**Sections:** General Options; System Default Class of Restrictions  
(Non-TIE); System Default Class of Restrictions (TIE);  
Barrier Code Administration

### GENERAL OPTIONS (ACCESS CODE 889)

Barrier Code required for Non-TIE DISA lines :Yes  
Barrier Code required for TIE DISA lines :Yes  
Automatic Queuing enabled for DISA lines :Yes  
System Wide Barrier Code Length: 07  
Date And Time of Last Barrier Code Length Change: 09:23:94, 09:45 PM

### SYSTEM DEFAULT CLASS OF RESTRICTIONS (NON-TIE)

Restriction : UNRESTRICTED  
ARS Restriction Level: 2  
Allowed Lists :  
Disallowed Lists : 7

### SYSTEM DEFAULT CLASS OF RESTRICTIONS (TIE)

Restriction : UNRESTRICTED  
ARS Restriction Level: 1  
Allowed Lists :  
Disallowed Lists : 7

### BARRIER CODE ADMINISTRATION

Barrier Code number : 1  
Barrier Digits : 2468345  
Restriction : OUTWARD RESTRICTED  
ARS Restriction Level: 3  
Allowed Lists :  
Disallowed Lists :

Barrier Code number : 2  
Barrier Digits : 1234693  
Restriction : UNRESTRICTED  
ARS Restriction Level: 3  
Allowed Lists :  
Disallowed Lists : 1,2,7

.  
.

Barrier Code number : 16  
Barrier Digits : 9876115  
Restriction : OUTWARD RESTRICTED  
ARS Restriction Level: 0  
Allowed Lists :  
Disallowed Lists :

## Disallowed Lists Report

---

Print Menu Option: DisallowLst  
Sections: Lists 1 through 7

### DISALLOWED LISTS

List : 0

Entry 0: -----  
Entry 1: -----  
Entry 2: -----  
Entry 3: -----  
Entry 4: -----  
Entry 5: -----  
Entry 6: -----  
Entry 7: -----  
Entry 8: -----  
Entry 9: -----

.  
.  
.

List : 7

Entry 0: 0  
Entry 1: 10  
Entry 2: 11  
Entry 3: 1809  
Entry 4: 1700  
Entry 5: 1900  
Entry 6: 1976  
Entry 7: lppp976  
Entry 8: \*  
Entry 9: -----

## Access to Disallowed Lists Report

---

Print Menu Option: DisallowTo

### ACCESS TO DISALLOWED LISTS

FOR REMOTE ACCESS 17 & 18 MEAN TIE & NON-TIE RESTRICTIONS

List	1	STNS	33
		RACC	9
List	3	STNS	33
		RACC	

# Automatic Route Selection Report

Print Menu Option: ARS  
 Sections: Tables

AUTOMATIC ROUTE SELECTION

ARS IS: ACTIVE ACCESS CODE: 9

TABLE 17: Default Toll Output Table

Pool	Absorb	Other Digits	FRL	Call type	Start	Pattern
1)70--	00	-----	2	BOTH	--:--	A
2)----	--	-----	-	-----	--:--	A
3)----	--	-----	-	-----	--:--	A
4)----	--	-----	-	-----	--:--	A
5)----	--	-----	-	-----	--:--	B
6)----	--	-----	-	-----	--:--	B

Pool	Absorb	Other Digits	FRL	Call type	Start	Pattern
1)70--	00	-----	2	BOTH	--:--	B
2)----	--	-----	-	-----	--:--	B
3)----	--	-----	-	-----	--:--	B
4)----	--	-----	-	-----	--:--	B
5)----	--	-----	-	-----	--:--	B
6)----	--	-----	-	-----	--:--	B

TABLE 18: Default Local Output Table

Pool	Absorb	Other Digits	FRL	Call type	Start	Pattern
1)70--	00	-----	2	BOTH	--:--	A
2)----	--	-----	-	-----	--:--	A
3)----	--	-----	-	-----	--:--	A
4)----	--	-----	-	-----	--:--	A
5)----	--	-----	-	-----	--:--	B
6)----	--	-----	-	-----	--:--	B

Pool	Absorb	Other Digits	FRL	Call type	Start	Pattern
1)70--	00	-----	2	BOTH	--:--	B
2)----	--	-----	-	-----	--:--	B
3)----	--	-----	-	-----	--:--	B
4)----	--	-----	-	-----	--:--	B
5)----	--	-----	-	-----	--:--	B

TABLE 19: Dial 0 Output Table

Pool	Absorb	Other Digits	FRL	Call type	Start	Pattern
1)70--	00	-----	3	BOTH	--:--	A

TABLE 20: N11 Output Table  
 01)411 02)611 03)811 04)911

Pool	Absorb	Other Digits	FRL	Call type	Start	Pattern
1)70--	00	-----	3	BOTH	--:--	A
1)70--	00	-----	3	BOTH	--:--	A

## Extension Directory Report

Print Menu Option: Ext Direct

EXTENSION DIRECTORY

Port	Ext #	Label	F H R M V R A 2	Port	Ext #	Label	F H R M V R A 2
Addr			A B C I S S R B	Addr			A B C I S S R B
			C I F C I T S D				C I F C I T S D
			E S W D G R R T				E S W D G R R T
1/ 1	10	OPERATR	N N N N U 3 N	1/21	710		N N N N U 3 N
1/ 2	11		N N N N O 3 Y	1/22	711		N N N N U 3 N
1/ 3	12		N N N N U 3 Y	1/23	712		N N N N U 3 N
1/ 4	13	EXT 13	N N N N U 3 N	1/24	713		N N N N U 3 N
1/ 5	14	EXT 14	N N N N U 3 N	1/25	714		N N N N U 3 N
1/ 6	15		N N N N U 3 N	1/26	715		N N N N U 3 N
1/ 7	16		N N N N U 3 N	1/27	716		N N N N U 3 N
1/ 8	17		N N N N U 3 N	1/28	717		N N N N U 3 N
2/ 1	18	EXT 18	N Y N N U 3 N	2/ 2	19		N Y N N U 3 N
2/ 3	20		N Y N N U 3 N	2/ 4	21		N Y N N U 3 N
2/ 5	22	OPERATR	N Y N N U 3 N	2/ 6	23		N Y N N U 3 N
2/ 7	24		N Y N N U 3 N	2/ 8	25		N Y N N U 3 N
3/ 1	26		N Y N N U 3 N	3/ 2	27		N Y N N U 3 N
3/ 3	28		N Y N N U 3 N	3/ 4	29		N Y N N U 3 N
3/ 5	30	AUDIXVP	N Y N N U 0 N	3/ 6	31		N Y N N U 3 N
3/ 7	32	AUDIXVP	N Y N N U 0 N	3/ 8	33		N Y N N U 3 N
4/ 1	34		N Y N N U 3 N	4/ 2	35	AUDIXVP	N Y N N U 0 N
4/ 3	36	AUDIXVP	N Y N N U 0 N	4/ 4	37		N Y N N U 3 N
4/ 5	38		N Y N N U 3 N	4/ 6	39		N Y N N U 3 N
4/ 7	40		N Y N N U 3 N	4/ 8	41		N Y N N U 3 N
6/ 1	42	EXT 42	N N N N U 3 N	6/21	742		N N N N U 3 N
.							
.							
7/ 1	54	EXT 54	N N N N U 3 N	7/2	754		N N N N U 3 N

## Extension Information Report

Print Menu Option: Ext Info plus extension number

### EXTENSION INFORMATION

Extn	SS/PP	Type
10	1/ 1	MLX-20L + 1 DSS

CTI Link	:	NO Alarms: ACTIVE (SUSPENDED)
Pool Access	:	70 890 891 892 893 894 895 896 897 898 899
Page Group	:	
Primary Coverage	:	
Secondary Coverage	:	
Coverage Group	:	5
Group Coverers	:	773
NS Groups	:	10
Group Calling Member	:	
Pickup Groups	:	
Allowed Lists	:	
Disallowed Lists	:	
Restrictions	:	UNRESTRICTED
ESS Sup. Status	:	ESS-0 -NO RESTRICTION
ESS Restrictions	:	ON
Auto Callback	:	OFF
Call Waiting	:	ON
Abbreviated Ring	:	ON
Line Preference	:	ON
Shared SA Ring	:	ON
Receive Voice Calls	:	ON
Coverage Inside	:	OFF
Forwarding to	:	
Delay Forwarding	:	0
ARS Restriction	:	3
Forced Account Code	:	No
Microphone Disable	:	No
Remote Forward Allow	:	No
Trunk Transfer Allow	:	No
NS Exclusion	:	No
Voice Announce Pair	:	No
Voice/Data Pair	:	No
BIS/HFAI	:	No
Language	:	English
Authorization Code	:	3134
2B Data Port	:	No
Primary Ring Delay	:	2
Secondary Ring Delay	:	2
Group Cover Delay	:	3
HotLine Extension	:	No
Display Preference	:	Name



## Extension Information Report— Continued

---

EXTENSION INFORMATION

Extn	SS/PP	Type	
10	1/ 1	MLX-20L + 1 DSS	
Button 34	Blank	Status	None
Button 33	Blank	Status	None
Button 32	Blank	Status	None
Button 31	Blank	Status	None
Button 30	Blank	Status	None
Button 29	Blank	Status	None
Button 28	Blank	Status	None
Button 27	Blank	Status	None
Button 26	Blank	Status	None
Button 25	Blank	Status	None
Button 24	Blank	Status	None
Button 23	Blank	Status	None
Button 22	Blank	Status	None
Button 21	Blank	Status	None
Button 20	Forced Release	Status	None
Button 19	Pool Inspect	Status	None
Button 18	Headset Auto Answer	Status	Off
Button 17	Join	Status	None
Button 16	Cancel	Status	None
Button 15	Alarm Status	Status	Off
Button 14	Night Service	Status	Off
Button 13	Headset Status	Status	Off
Button 12	Destination	Status	None
Button 11	Release	Status	None
Button 10	Position Busy	Status	Off
Button 9	Send/Remove Message	Status	None
Button 8	Handset/Headset Mute	Status	Off
Button 7	Source	Status	None
Button 6	Start	Status	None
Button 5	Call 5	Status	None
Button 4	Call 4	Status	None
Button 3	Call 3	Status	None
Button 2	Call 2	Status	None
Button 1	Call 1	Status	None

## Direct Group Calling Information Report (Local Members Only)

---

Print Menu Option: GrpCalling

DIRECT GROUP CALLING INFORMATION

Group # : 770                    Group Type : IntegrtdVMI  
Call Distribution Type : CIRCULAR

PryAnn No.	EXT #	LABEL
	1	
	2	
	.	
	.	
	10	

Secondary Announcement Ext # :  
Time Between Delay Announcements: 0  
Repeat Secondary Announcement: No

Message Waiting Station :

Queue Control Limit: 99  
Calls\_in\_queue Threshold 1: 1  
Calls\_in\_queue Threshold 2: 1  
Calls\_in\_queue Threshold 3: 1  
External Alert ext # :  
Overflow Threshold (#) : 1  
Overflow Threshold (Time): 0  
Prompt Based Overflow Option: No  
Overflow to DGC group # :

Group Coverage : 1

Member No.	EXT #	LABEL
	1	6131
	2	6132
	3	
	.	
	.	
	.	
	20	

LINES :

## Direct Group Calling Information Report (Single Non-Local Member)

---

Print Menu Option: GrpCalling

DIRECT GROUP CALLING INFORMATION

Group # : 771                    Group Type : IntegrtdVMI  
Call Distribution Type : CIRCULAR

PryAnn No.	EXT #	LABEL
	1	
	2	
	.	
	.	
	10	

Secondary Announcement Ext # :  
Time Between Delay Announcements: 0  
Repeat Secondary Announcement: No

Message Waiting Station :

Queue Control Limit: 99  
Calls\_in\_queue Threshold 1: 1  
Calls\_in\_queue Threshold 2: 1  
Calls\_in\_queue Threshold 3: 1  
External Alert ext # :  
Overflow Threshold (#) : 1  
Overflow Threshold (Time): 0  
Prompt Based Overflow Option: No  
Overflow to DGC group # :

Group Coverage :

Member No.	EXT #	LABEL
	1	5300

LINES :

## Error Log Report

---

Print Menu Option: Error Log

ERROR LOG

Last 30 System Errors:

Message	ss/pp	Cnt	First	Last	Code
PRI SVC AUDIT TIMEOUT	00/00	-	-	01/08 00:00:53	7001
TIMEOUT COLD START	00/00	-	-	01/11 00:04:08	0001
PRI SVC AUDIT TIMEOUT	00/00	-	-	01/11 00:04:14	7001
TIMEOUT COLD START	00/00	-	-	01/21 00:22:14	0001
PRI SVC AUDIT TIMEOUT	00/00	-	-	01/03 00:22:14	7001
PRI SVC AUDIT TIMEOUT	00/00	-	-	01/04 00:22:14	7001
SOFTWARE COLD START	00/00	-	-	01/04 00:21:14	0003
SOFTWARE COLD START	00/00	-	-	01/04 00:21:14	0003
PRI SVC AUDIT TIMEOUT	00/00	-	-	01/04 00:21:14	7001
SOFTWARE COLD START	00/00	-	-	01/04 00:22:11	0003
PRI SVC AUDIT TIMEOUT	00/00	-	-	01/08 00:00:53	7001
TIMEOUT COLD START	00/00	-	-	02/11 00:04:08	0001
PRI SVC AUDIT TIMEOUT	00/00	-	-	02/11 00:04:14	7001
TIMEOUT COLD START	00/00	-	-	02/21 00:22:14	0001
PRI SVC AUDIT TIMEOUT	00/00	-	-	02/03 00:22:14	7001
PRI SVC AUDIT TIMEOUT	00/00	-	-	02/04 00:22:14	7001
SOFTWARE COLD START	00/00	-	-	02/04 00:21:14	0003
SOFTWARE COLD START	00/00	-	-	02/04 00:21:14	0003
PRI SVC AUDIT TIMEOUT	00/00	-	-	02/04 00:21:14	7001
SOFTWARE COLD START	00/00	-	-	02/04 00:22:11	0003
PRI SVC AUDIT TIMEOUT	00/00	-	-	02/08 00:00:53	7001
TIMEOUT COLD START	00/00	-	-	03/11 00:04:08	0001
PRI SVC AUDIT TIMEOUT	00/00	-	-	03/11 00:04:14	7001
TIMEOUT COLD START	00/00	-	-	03/21 00:22:14	0001
PRI SVC AUDIT TIMEOUT	00/00	-	-	03/03 00:22:14	7001
PRI SVC AUDIT TIMEOUT	00/00	-	-	03/04 00:22:14	7001
SOFTWARE COLD START	00/00	-	-	03/04 00:21:14	0003
SOFTWARE COLD START	00/00	-	-	03/04 00:21:14	0003
PRI SVC AUDIT TIMEOUT	00/00	-	-	03/04 00:21:14	7001

## Switch 56 Data Information Report

---

Print Menu Option: Switch 56

Dial Plan Routing for Network Service

Expected Digits: 3

Digits to Delete: 0

Digits to Add: 0

Trk	ss/pp	Dirction	InType	OutType	AnsSup	Discnt	Inmode	Outmode	Service
801	02/01	2 Way	Wink	Wink	120	180	T-Tone	T-Tone	TIE
802	02/02	Outgoing	Delay	Delay	160	180	Rotary	T-Tone	S56
803	02/03	Incoming	Auto	Auto	100	140	Rotary	Rotary	S56
.									
.									
.									
808	02/08	2 Way	Wink	Wink	120	180	Rotary	Rotary	TIE



## Voice/Fax Messaging Systems



---

This appendix provides voice/fax messaging system requirements that must be followed for the voice messaging system to route calls to non-local extensions.

MERLIN LEGEND Communications System Release 6.0 Version 11 or later software must be used when the customer's configuration includes an automated attendant that will be used to route calls across a private network. Release 6.1 or later must be used when the customer's configuration includes a centralized voice messaging system.



**NOTE:**

With Release 6.0 Version 11, a centralized automated attendant cannot answer lines that reside on a remote networked switch. This capability is included in Release 6.1.

## Supported System Considerations

---

The following are considerations for voice messaging systems used for centralized automated attendant on MERLIN LEGEND Communications System Release 6.0 Version 11 and later systems.

### MERLIN LEGEND System

---

For Release 6.1 and later systems, the number of dialed digits for the non-local UDP range for a given pattern must be entered in a new system programming screen (14.515). To access this screen, select SysRenumber.NonLocal UDP.Enter first extension number in range..Enter last extension number in range..Enter number of dialed digits for the range..

### Intuity AUDIX

---

- All local and non-local UDP stations must be administered on Intuity AUDIX.
- Within Intuity AUDIX, the parameter “transfer to subscribers only” must be administered so as to ensure that Intuity AUDIX will deny transfers to all but local and non-local UDP stations.
- When optioned for MERLIN LEGEND systems, Intuity AUDIX can handle 3- or 4-digit dial plans (but not both simultaneously). For example, you cannot have a 3-digit dial plan for one site and a 4-digit dial plan at another site. Note that since a 5-digit dial plan is not supported by Intuity AUDIX when optioned for MERLIN LEGEND systems, one of the work-arounds described in Chapter 5 must be used to route calls to DEFINITY ECS or DEFINITY ProLogix or the DEFINITY must have a 4-digit dial plan.
- The MAP/5P platform supports 500 subscribers, the MAP/40 supports 3000 subscribers, and the MAP/100 supports 6000 subscribers.
- Beginning with Intuity AUDIX R4, enhanced transfer security is available by administering the allowed numbers list. Unless an extension (local and non-local UDP) appears in this list, calls will not be transferred to that number.

### MERLIN LEGEND Mail

---

- MERLIN LEGEND Mail should be set up with “Transfer to Subscriber-Only Restrictions.”
- For local UDP extensions, call answer mailboxes (up to 100) should be used.
- For non-local UDP numbers, transfer-only mailboxes should be used. The maximum number of mailboxes of both types is 375.



## Messaging 2000

---

- All local and non-local UDP extensions must be programmed as mailboxes.
- Messaging 200 can handle 2- 3- or 4-digit dial plans but not simultaneously. All MERLIN LEGEND systems sharing the Messaging 2000 must be renumbered to the same number of digits in the dial plan.

## IS-III AUDIX Voice Power

---

Existing AUDIX Voice Power systems can be used for centralized VMS/AA, but this system can no longer be ordered.

- The AUDIX Voice Power Directory consists of the local UDP extensions (“Subscribers”) and the non-local UDP numbers (“Special Extensions”). This directory should not exceed 300 entries (maximum number of mailboxes). When the dialed number does not match one of the numbers in the Directory, the attempt to transfer the call is denied.
- When using *analog* tandem tie trunks as private network facilities, each remote (non-local UDP) station must be added to the AUDIX Voice Power Directory’s database with Class of Service set to Custom and Switch Call Coverage set to Yes. Otherwise, the transfer will fail unconditionally.
- When using T1 tie and/or PRI tandem trunks as private network facilities, each local UDP station must be added to the database, but the Class of Service setting and the Switch Call Coverage setting do not affect operation. The maximum number of rings (0-9) is not required with Switch Call Coverage, but is required when no Switch Call Coverage is specified.

## Fax Messaging in a Centralized Voice Mail Configuration

---

Both the Messaging 2000 and Intuity AUDIX systems have fax messaging capabilities. Both systems can have faxes sent to the same mailbox as voice messages, but users often find this operation inconvenient when they have to transfer a fax call back to their mailbox. The most common operation is to have a separate mailbox for fax messages that are forwarded to the voice mailbox. By doing so, the user retrieves voice and fax messages from one mailbox and isn't bothered by answering fax calls.

To set-up a mailbox on the MERLIN LEGEND system to receive faxes, you administer an MFM or SLS as the fax number (mailbox) then assign it to coverage. You also change the number of group coverage rings to 1. The call is handled just like a call over the private network. An incoming call from the PSTN rings at an endpoint (MFM or SLS), then is routed through the private network as a coverage call.

The following considerations apply when fax messaging is used in a centralized voice mail configuration:

- There is a possibility that faxes may become corrupted if clock synchronization is established improperly. A single clocking source must be provided for the entire private network. When establishing a MERLIN LEGEND private network, be sure to consult the Network Reference guide for procedures on selecting the clocking source.
- Most fax machines will dial a number, wait 30 seconds for the fax tone and if no tone is received, the sending fax hangs up (and often goes into the redial mode). If it takes longer than 30 seconds for a fax call to cover across a private network to a messaging system, fax messages may never be received. To assure the fastest call set-up in a private network, PRI tandem trunks are recommended.

# Touch-Tone Receiver Requirements



This appendix includes information to aid in determining Touch-Tone Receiver requirements for private network systems.

## System Requirements for Touch-Tone Receivers

---

A voice messaging system requires a certain number of TTRs in addition to any system requirements for TTRs. The number of TTRs depends on the number of ports used by the voice messaging system (see [Table D-1](#)). TTRs are also required in private networks using E&M, T1 tie, and tandem tie trunks.

In Release 6.0 and later systems, the use of the Prompt-Based Overflow setting, which allows callers to request overflow coverage while waiting in a calling group queue, requires TTRs for primary and secondary delay announcement devices that present the option to callers.

**Table D-1. TTRs Required by VMS/AA**

Number of VMS Ports	Number of TTRs Required
1	1
2	1
3	2
4	2
6	3
8	4
12*	6*
18	8

\*If a 12-port MERLIN LEGEND Enhanced Service Center is used, 8 TTRs are required.

[Table D-2](#) estimates the total number of TTRs required in the system, based on call volume and whether the system uses account codes. The call volume per hour in this table includes all calls originating from single-line telephones, calls on tie lines, incoming remote access and DID calls.



**NOTE:**

You must consider the call traffic across a private network when estimating the number of required TTRs. This includes calls on analog tandem tie trunks and T1-emulated tandem tie trunks. In addition, if your private network includes Centralized Voice Messaging, you must consider the call traffic coming across the private network for the voice messaging system and the TTRs required for the updating of Message Waiting lights (Release 6.1 or later systems). For this updating, a TTR is required at the sending end and the receiving end. If the systems in the private network are connected by PRI trunks, no additional TTRs are needed.

**Table D-2. System Requirement for TTRs**

Calls/Hour	TTRs Required	
	No Account Codes Used	Account Codes Used
110	2	4
180	4	6
350	4	8
420	6	8
610	6	10
710	8	10

[Table D-3](#) shows the TTRs required for primary delay announcement devices.

**Table D-3. TTRs Required for Primary Delay Announcement Devices When Using Prompt-Based Overflow**

Number of Devices	Number of TTRs Required
1	1
2	2
3	3
4	4
5	4
6	5
7	5
8 or more	6

[Table D-4](#) shows the TTRs required for secondary delay announcement devices.

**Table D-4. TTRs Required for Secondary Delay Announcement Devices When Using Prompt-Based Overflow**

Number of Devices	Number of TTRs Required
1	1
2	1
3	1
4	2
5	2
6	2
7	3
8	3
9	3
10 or more	4

The following modules supply TTRs for the MERLIN LEGEND Communications System.

**Table D-5. Modules with TTRs**

Module	No. of TTRs
008 OPT	2
012	2
016 (T/R)	4
400 GS/LS	4
400 (LS)	4
800 DID	2
800 LS-ID	2
MERLIN LEGEND Mail module	2

The following symptoms indicate that the system needs more TTRs.

- Single-line telephone users do not get dial tone when they lift the handset to dial out.
- The voice messaging system fails to transfer calls.
- Calls fail to ring or go to coverage prematurely.
- Reorder tone on UDP/ARS calls using tandem tie trunks.
- Delay in MWL tie trunks when tie trunks are available.





# Glossary

---

## Italics

The use of italics in the glossary denotes multiple usage of the italicized text throughout the glossary.

---

## Numerics

**2B data** Digital information carried by two *B-channels* for better performance and quality; the *bit rate* is twice that of one B-channel used alone.

**7500B data module** See *ISDN 7500B Data Module*

---

## A

**account code** Code used to associate incoming and outgoing calls with corresponding accounts, employees, projects, and clients.

**ACCUNET** AT&T's switched digital service for 56-kbps, 64-kbps restricted, and 64-kbps clear circuit-switched data calls.

**address** A coded representation of the destination of data or of the data's originating terminal, such as the dialed extension number assigned to the data terminal. Multiple terminals on one communications line must each have a unique address.

**ADDS** (Automated Document Delivery System) Computer-based application that stores documents in a database and automatically faxes them on request.

**adjunct** Optional equipment used with the communications system, such as an alerting device or *modem* that connects to a multiline telephone or to an extension jack.

**ALS** (Automatic Line Selection) Programmed order in which the system makes outside lines available to a user.

**ambiguous numbering** Numbering of extension ranges, remote access codes, or other system components that causes conflicts in network operations. These numbers can be unique and still be ambiguous. For example, Extension 441 is different from Extension 4410. However, for *UDP routing* purposes, the two numbers are ambiguous and a call intended for Extension 4410 is misrouted on the first three digits sent, to Extension 441. See also *unambiguous numbering*.

<b>AMI</b>	(alternate mark inversion) Line coding format in which a binary one is represented by a positive or negative pulse, a binary zero is represented by no line signal, and subsequent binary ones must alternate in polarity; otherwise, a <i>bipolar violation</i> occurs. AMI is used in the <i>DS1</i> interface.
<b>Analog data station</b>	See <i>modem data station</i> .
<b>analog transmission</b>	Mode of transmission in which information is represented in continuously variable physical quantities, such as amplitude, frequency, phase, or resistance. See also <i>digital transmission</i> .
<b>ANI</b>	(Automatic Number Identification) Process of automatically identifying a caller's billing number and transmitting that number from the caller's local central office to another point on or off the public network.
<b>application</b>	Software and/or hardware that adds functional capabilities to the system. For example, MERLIN Identifier is an application that provides caller identification information (if available in the local area or jurisdiction).
<b>ARS</b>	(Automatic Route Selection) System feature that routes calls on outside facilities according to the number dialed and line/trunk availability. To initiate ARS, the user dials a <i>dial-out code</i> , also called an "ARS access code."
<b>ASCAP</b>	(American Society of Composers, Artists, and Producers)
<b>ASN</b>	(AT&T Switched Network) AT&T telecommunications services provided through an Integrated Digital Services Network Primary Rate Interface (ISDN-PRI) trunk, <i>Accunet</i> switched digital service, <i>Megacom</i> , <i>Megacom 800</i> , Software Defined Network ( <i>SDN</i> ), Multiquest, and Shared Access for Switch Services ( <i>SASS</i> ).
<b>asynchronous data transmission</b>	A method of transmitting a short bitstream of digital data, such as printable characters represented by a 7- or 8-bit ASCII code. Each string of data bits is preceded by a start bit and followed by a stop bit, thus permitting data to be transmitted at irregular intervals. See also <i>synchronous data transmission</i> .
<b>AT&amp;T Attendant</b>	Application with equipment that connects to one or more <i>tip/ring</i> extension jacks and automatically answers incoming calls with a recorded announcement; directs calls in response to touch tones.
<b>AT&amp;T Switched Network</b>	See <i>ASN</i> .
<b>AUDIX Voice Power</b>	A voice-processing application, part of <i>IS II/III</i> , that provides Automated Attendant, Call Answer, Information Service, Message Drop, Voice Mail, and, optionally, <i>Fax Attendant System</i> for use with the system.

<b>Automated Attendant</b>	<i>IS II/III, MERLIN LEGEND MAIL, and Lucent Technologies Attendant</i> application that automatically answers incoming calls with a recorded announcement and directs callers to a department, an extension, or the system operator.
<b>Automated Document Delivery System</b>	See <i>ADDs</i> .
<b>automatic immediate cycling</b>	Process that occurs in private network when all available routes for a call specify systems with matching <i>switch identifiers</i> . The call is routed from the originating system to the destination system and back to the originating system in a continuous loop. <i>Switch identifiers</i> labelling systems must be unique across a network.
<b>Automatic Line Selection</b>	See <i>ALS</i> .
<b>Automatic Number Identification</b>	See <i>ANI</i> .
<b>automatic ringdown tie-trunk</b>	See <i>automatic-start tie trunk</i> .
<b>Automatic Route Selection</b>	See <i>ARS</i> .
<b>automatic-start tie trunk</b>	<i>Tie trunk</i> on which incoming calls are routed to an operator or other designated destination without a start signal, as soon as the trunk is seized; the destination is specified during programming. Also called "automatic ringdown" or "auto-in" tie trunk.
<b>auxiliary power unit</b>	Device that provides additional power to the system.

---

**B**

<b>B8ZS</b>	(bipolar 8 zero substitution) Line-coding format that encodes a string of eight zeros in a unique binary sequence to detect bipolar violations.
<b>backup</b>	Procedure for saving a copy of system programming onto a floppy disk or <i>memory card</i> . See also <i>restore</i> .
<b>bandwidth</b>	Difference, expressed in hertz, between the highest and lowest frequencies in a range that determines channel capacity.
<b>barrier code</b>	Password used to limit access to the <i>Remote Access</i> feature of the system. In a <i>private network</i> , it is especially important that barrier codes be required for all types of remote access.
<b>basic carrier</b>	Hardware that holds and connects the <i>processor module, power supply module, and up to five other modules</i> in the system. See also <i>expansion carrier</i> .

<b>baud rate</b>	Strictly speaking, a measurement of transmission speed equal to the number of signal level changes per second. In practice, often used synonymously with <i>bit rate</i> and <i>bps</i> .
<b>B-channel</b>	(Bearer-channel) 64- or 56-kbps channel that carries a variety of digital information streams, such as voice at 64 kbps, data at up to 64 kbps, wideband voice encoded at 64 kbps, and voice at less than 64 kbps, alone or combined.
<b>Basic Rate Interface</b>	See <i>BRI</i> .
<b>Bearer-channel</b>	See <i>B-channel</i> .
<b>Behind Switch mode</b>	One of three modes of system operation, in which the control unit is connected to (behind) another telephone switching system, such as <i>Centrex</i> or <i>DEFINITY</i> , which provides features and services to telephone users. See also <i>Hybrid/PBX mode</i> and <i>Key mode</i> .
<b>binary code</b>	Electrical representation of quantities or symbols expressed in the base-2 number system, which includes zeros and ones.
<b>bipolar 8 zero substitution</b>	See <i>B8ZS</i> .
<b>bipolar signal</b>	Digital signal in which pulses (ones) alternate between positive and negative. See also <i>AMI</i> , <i>B8ZS</i> , and <i>bipolar violation</i> .
<b>bipolar violation</b>	Condition occurring when two positive or two negative pulses are received in succession. See also <i>AMI</i> and <i>B8ZS</i> .
<b>BIS</b>	(Built-In Speakerphone) Part of the model name of some analog multiline telephones.
<b>bit</b>	(binary digit) One unit of information in binary notation; it can have one of two values, zero or one.
<b>bit rate</b>	Speed at which bits are transmitted, usually expressed in <i>bps</i> . Also called "data rate."
<b>blocking</b>	Condition in which end-to-end connections cannot be made on calls because of a full load on all possible services and facilities. See also <i>glare</i> .
<b>BMI</b>	(Broadcast Music Incorporated)
<b>board</b>	A module, for example, 100D or 408 MLX GS/LS, that allows you to connect lines/trunks and extensions to the communications system.
<b>board assignment</b>	System Programming and Maintenance (SPM) procedure for assigning line/trunk and extension modules to slots on the control unit.
<b>board renumbering</b>	System programming procedure for renumbering boards that have already been assigned to specific slots on the control unit.

<b>BRI</b>	(Basic Rate Interface) A standard protocol for accessing Integrated Service Digital Network (ISDN) services.
<b>broadband</b>	Transmission path having a bandwidth greater than a voice-grade channel.
<b>BTMI</b>	(basic telephone modem interface)
<b>bus</b>	Multiconductor electrical path used to transfer information over a common connection from any of several sources to any of several destinations.
<b>button</b>	Key on the face of a telephone that is used to access a line, activate a feature, or enter a code on a communications system.
<b>byte</b>	Sequence of <i>bits</i> (usually eight) processed together. Also called "octet."

---

C

<b>Call Accounting System</b>	See <i>CAS</i> .
<b>Call Accounting Terminal</b>	See <i>CAT</i> .
<b>Caller ID</b>	A service provided by some local telephone companies (if local regulations allow) that supplies the calling party telephone number. In Release 3.0 and later, an 800 GS/LS-ID module on the system can capture this information and display it on the screens of MLX telephones. See also <i>ANI</i> .
<b>Calling group</b>	Team of individuals who answer the same types of calls.
<b>Call Management System</b>	See <i>CMS</i> .
<b>CAS</b>	(Call Accounting System) DOS- or UNIX System-based application that monitors and manages telecommunications costs.
<b>CAT</b>	(Call Accounting Terminal) Standalone unit with a built-in microprocessor and data buffer that provides simple call accounting at a low cost.
<b>CCITT</b>	(International Telegraph and Telephone Consultative Committee)
<b>CCS</b>	(common-channel signaling) Signaling in which one channel of a group of channels carries signaling information for each of the remaining channels, permitting each of the remaining channels to be used to nearly full capacity. In the system's 100D module, channel 24 can be designated as the signaling channel for channels 1–23.
<b>Central Voice Mail</b>	A voice mail system that can service two or more directly connected MERLIN Legend Communications systems in a network.

<b>centralized telephone programming</b>	Programming of features on individual telephones; performed at a central location by the system manager. See also <i>system programming</i> and <i>extension programming</i> .
<b>central office</b>	See <i>CO</i> .
<b>Centrex</b>	Set of system features to which a user can subscribe on telephone trunks from the local telephone company.
<b>channel</b>	Telecommunications transmission path for voice and/or data.
<b>channel service unit</b>	See <i>CSU</i> .
<b>checksum</b>	Sum of ones in a sequence of ones and zeros used to detect or correct errors in data transmission.
<b>circuit-switched data call</b>	Data call made through an exclusively established and maintained connection between <i>data stations</i> .
<b>class of restriction</b>	See <i>COR</i> .
<b>clear data channel</b>	Clear data channels (also called unrestricted data channels) allow the transmission of occurrences of more than seven contiguous zero bits. If a clear data channel is requested and only restricted channels are available, the call will be rejected. See also restricted data channel.
<b>clock synchronization</b>	When digital signals are transmitted over a communications link, the receiving end must be synchronized with the transmitting end to receive the digital signals without errors using clock synchronization. A system synchronizes itself by extracting a timing signal from an incoming digital stream. All the digital facilities in a network operate from a single common clock, preferably a port connected to a digital <i>PSTN</i> facility on a <i>hub system</i> or a system that connects two network systems. In this case, all digital facilities specify a loop clock source. One system in a network may be specified as a local clock source when no functioning digital facility in the network is connected to the <i>PSTN</i> . All other digital facilities then use this clock and specify their clock sources as loop. Primary, secondary, and tertiary clock sources are specified to allow backup synchronization in the event that the primary source is out of service.
<b>CMS</b>	(Call Management System) DOS-based application that simulates the actions of a system operator by answering and distributing calls. Also produces reports for call analysis.
<b>CO</b>	(central office) Location of telephone switching equipment that provides local telephone service and access to toll facilities for long-distance calling.
<b>coaxial cable</b>	Cable consisting of one conductor, usually a small copper tube or wire within and insulated from another conductor of larger diameter, usually copper tubing or copper braid.

<b>codec</b>	(coder-decoder) Device used to convert analog signals such as speech, music, or television to digital form for transmission over a digital medium and back to the original analog form.
<b>collected digits</b>	Digits that a caller dials in response to an integrated voice response application's menus (also called <i>prompted digits</i> ); collected digits may be used to initiate <i>screen pop</i> at a system extension. See also <i>CTI link</i> .
<b>combination configuration</b>	A <i>private network</i> arrangement that combines characteristics of <i>Virtual Private Network (VPN)</i> , a <i>series configuration</i> , and a <i>star configuration</i> .
<b>common channel signaling</b>	See <i>CCS</i> .
<b>communications system</b>	Software-controlled processor complex that interprets dialing pulses, tones, and/or keyboard characters and makes the proper interconnections both inside and outside. Consists of a computer, software, a storage device, and carriers with special hardware to perform the actual connections. Provides voice and/or data communications services, including access to public and private networks, for telephones and other equipment. Also referred to in this guide as "system," short for MERLIN LEGEND Communications System.
<b>control unit</b>	<i>Processor module, power supply module, other modules, carriers, and housing of the system.</i>
<b>console</b>	Telephone and <i>adjuncts</i> (if any) at operator or system programmer extension.
<b>CONVERSANT</b>	Entry-level voice response application that automatically answers and routes calls and executes telephone transactions.
<b>conversion resource</b>	See <i>modem pool</i> .
<b>coordinating system manager</b>	In a <i>private network</i> that includes more than two systems, the system manager who acts as a clearinghouse for any changes made on local systems, that effect the network, assuring that all system managers work together and that local system changes do not have undesirable effects on the network as a whole.
<b>COR</b>	(class of restriction) Various types of restrictions that can be assigned to <i>remote access</i> trunks or barrier codes. These restrictions consist of calling restrictions, <i>ARS</i> Facility Restriction Levels ( <i>FRLs</i> ), Allowed Lists, Disallowed Lists, and Automatic Callback queuing.
<b>Coverage</b>	Set of system features that can determine how extensions' calls are covered when the person at the extension is busy or not available.
<b>CRC</b>	(cyclic redundancy check) An error-detection code used on <i>DS1</i> facilities with the extended superframe format ( <i>ESF</i> ).

<b>CSU</b>	(channel service unit) Equipment used on customer premises to provide <i>DS1</i> facility terminations and signaling compatibility.
<b>CTI link</b>	(Computer Telephony Integration) link. A hardware/software feature that is part of the PassageWay Telephony Services application. It allows the use of Lucent Technologies-certified software applications on a <i>LAN</i> running Novell NetWare software in a <i>Hybrid/PBX mode</i> system. These applications may provide special features for client control of such calling activities as power dialing. See also <i>screen pop</i> .
<b>cyclic redundancy check</b>	See <i>CRC</i> .

---

## D

<b>D4 framing format</b>	<i>Framing format</i> consisting of a sequence of individual frames of 24 eight-bit slots and one signal bit (193 bits) in a 12-frame superframe. See also <i>ESF</i> .
<b>Data-channel</b>	See <i>D-channel</i> .
<b>data communications equipment</b>	See <i>DCE</i> .
<b>data module</b>	A type of <i>ISDN terminal adapter</i> that acts as the <i>DCE</i> at a <i>data workstation</i> that communicates over high-speed <i>digital</i> facilities.
<b>data rate</b>	See <i>bps</i> .
<b>data station</b>	Special type of extension where data communications take place; includes <i>DTE</i> and <i>DCE</i> ; sometimes a telephone is also part of a data station.
<b>data terminal</b>	An input/output device (often a personal computer) that can be connected to the control unit via an interface.
<b>data terminal equipment</b>	See <i>DTE</i> and <i>data terminal</i> .
<b>data workstation</b>	Special type of extension where data communications take place; includes <i>DTE</i> and <i>DCE</i> ; sometimes a telephone is also part of a data workstation.
<b>DCE</b>	(data communications equipment) Equipment such as <i>modems</i> or <i>ISDN terminal adapters</i> used to establish, maintain, and terminate a connection between the system and data terminal equipment ( <i>DTE</i> ), such as printers, personal computers, host computers, or network workstations.
<b>DCP</b>	(Digital Communications Protocol) AT&T proprietary protocol to transmit digitized voice and data over the same communications link.



<b>D-channel</b>	(Data-channel) 16- or 64-kbps channel that carries signaling information or data on a <i>PRI</i> or <i>BRI</i> .
<b>dedicated feature buttons</b>	The imprinted feature buttons on a telephone: <b>Conf</b> or <b>Conference</b> , <b>Drop</b> , <b>Feature</b> , <b>HFAI</b> (Hands Free Answer on Intercom), <b>Hold</b> , <b>Message</b> , <b>Mute</b> or <b>Microphone</b> , <b>Recall</b> , <b>Speakerphone</b> or <b>Spkrphone</b> , and <b>Transfer</b> .
<b>delay-start tie trunk</b>	<i>Tie trunk</i> or <i>tandem tie trunk</i> on which the originating end of the tie trunk transmits an off-hook signal to the receiving end and waits for the receiving end to send an off-hook signal followed by an on-hook signal. Also called "dial-repeating tie trunk."
<b>desktop videoconferencing system</b>	A system application that allows face-to-face, simultaneous video and voice communications between individuals and requires high-speed data transmission facilities. See also <i>group videoconferencing system</i> .
<b>DFT</b>	(direct facility termination) See <i>personal line</i> .
<b>DHG</b>	(data hunt group) Group of analog or digital <i>data stations</i> that share a common access code. Calls are connected in a round-robin fashion to the first available data station in the group.
<b>dial access</b>	See <i>feature code</i> .
<b>Dialed Number Identification Service</b>	See <i>DNIS</i> .
<b>dial-out code</b>	Digit (usually a 9) or digits dialed by telephone users to get an outside line.
<b>dial plan</b>	Numbering scheme for system extensions, lines, and trunks.
<b>dial-repeating tie trunk</b>	<i>Tie trunk</i> on which the originating end of the tie trunk transmits an off-hook signal to the receiving end and waits for the receiving end to send an off-hook signal followed by an on-hook signal. Also called "dial-repeating tie trunk."
<b>DID</b>	(Direct Inward Dial) Service that transmits from the telephone company central office and routes incoming calls directly to the called extension, <i>calling group</i> , or outgoing line/trunk <i>pool</i> , bypassing the system operator.
<b>DID trunk</b>	Incoming trunk that receives dialed digits from the local exchange, allowing the system to connect directly to an extension without assistance from the system operator.
<b>digital</b>	Representation of information in discrete elements such as off and on or zero and one. See also <i>analog transmission</i> .
<b>Digital Communications Protocol</b>	See <i>DCP</i> .
<b>digital data station</b>	See <i>ISDN terminal adapter data station</i> .
<b>Digital Signal 0</b>	See <i>DS0</i> .

<b>Digital Signal 1</b>	See <i>DS1</i> .
<b>digital subscriber line</b>	See <i>DSL</i> .
<b>digital switch element</b>	See <i>DSE</i> .
<b>digital transmission</b>	Mode of transmission in which the information to be transmitted is first converted to digital form and then transmitted as a serial stream of pulses. See also <i>analog transmission</i> .
<b>DIP switch</b>	(dual in-line package) Switch on a 400EM module used to select the signaling format for tie-line transmission. Also used on other equipment for setting hardware options.
<b>direct facility termination</b>	(DFT) See <i>personal line</i> .
<b>Direct Inward Dial</b>	See <i>DID</i> .
<b>Direct-Line Console</b>	See <i>DLC</i> .
<b>Direct Station Selector</b>	See <i>DSS</i> .
<b>display buttons</b>	Buttons on an MLX display telephone used to access the telephone's display.
<b>DLC</b>	(Direct-Line Console) Telephone used by a system operator to answer outside calls (not directed to an individual or a group) and inside calls, transfer calls, make outside calls for users with outward calling restrictions, set up conference calls, and monitor system operation.
<b>DNIS</b>	(Dialed Number Identification Service) Service provided by AT&T and MCI; it routes incoming 800 or 900 calls according to customer-selected parameters, such as area code, state, or time of call.
<b>door answering unit</b>	Device connected to a basic telephone jack and used at an unattended extension or front desk.
<b>DOS</b>	(disk operating system)
<b>drop-and-insert equipment</b>	A device that can be installed between systems connected by <i>tandem PRI trunks</i> or T1-emulated <i>tandem tie trunks</i> to allow fractional use of the facility, that is, use of fewer than 23 of the PRI <i>B-channels</i> or fewer than 24 of the T1 <i>channels</i> . In a PRI facility, the equipment must never drop Channel 24, the <i>D-channel</i> . All channels must still be programmed and all count towards the system maximum of 80 lines.
<b>DS0</b>	(Digital Signal 0) Single 64-kbps voice or data channel.
<b>DS1</b>	(Digital Signal 1) <i>Bit</i> -oriented signaling interface that multiplexes twenty-four 64-kbps channels into a single 1.544-Mbps stream.

<b>DSL</b>	(Digital Subscriber Line) A Digital Subscriber Line provides full-duplex service on a single twisted metallic pair (2-wire) at a rate sufficient to support ISDN Basic Rate Access.
<b>DSS</b>	(Direct Station Selector) 60-button <i>adjunct</i> that enhances the call-handling capabilities of an MLX-20L or MLX-28D telephone used as an operator console.
<b>DTE</b>	(data terminal equipment) Equipment that makes the endpoints in a connection over a data connection; for example, a data terminal, personal computer, host computer, or printer.
<b>DTMF signaling</b>	(dual-tone multifrequency signaling) Touch-tone signaling from telephones using the voice transmission path. DTMF signaling provides 12 distinct signals, each representing a dialed digit or character, and each composed of two voiceband frequencies.

---

## E

<b>E&amp;M</b>	Ear and Mouth. Synonymous with analog <i>tie trunk</i> .
<b>E&amp;M signaling</b>	Trunk supervisory signaling, used between two communications systems, in which signaling information is transferred through two-state voltage conditions (on the Ear and Mouth leads) for analog applications and through two <i>bits</i> for digital applications. See also <i>tie trunk</i> .
<b>EIA</b>	(Electronic Industries Association)
<b>EIA-232-D</b>	Physical interface, specified by the <i>EIA</i> , that transmits and receives asynchronous data at speeds of up to 19.2-kbps over cable distances of 50 feet (15 m).
<b>Electronic Switching System endpoint</b>	See <i>ESS</i> .
<b>ESF</b>	(extended superframe format) <i>PRI</i> framing format consisting of individual frames of 24 eight-bit slots and one signal bit (193 bits) in a 24-frame extended superframe.
<b>ESS</b>	(Electronic Switching System) Class of central office ( <i>CO</i> ) switching systems developed by Lucent Technologies in which the control functions are performed principally by electronic data processors operating under the direction of a stored program.
<b>expansion carrier</b>	Carrier added to the control unit when the basic carrier cannot house all of the required modules. Houses a power supply module and up to six additional modules.

<b>ExpressRoute 1000</b>	Data communications device that allows connection between an RS-232 <i>DTE</i> device and the control unit using MLX extension jacks on the 008 MLX or 408 GS/LS-MLX module.
<b>extended superframe format</b>	See <i>ESF</i> .
<b>extension</b>	An endpoint on the internal side of the communications system. An extension can be a telephone with or without an adjunct. Also called "station." See also <i>data workstation</i> .
<b>extension jack</b>	An analog, digital, or <i>tip/ring</i> physical interface on a module in the control unit for connecting a telephone or other device to the system. Also called "station jack."
<b>extension programming</b>	Programming performed at an extension to customize telephones for personal needs; users can program features on buttons, set the telephone ringing pattern, and so on. See also <i>centralized telephone programming</i> and <i>system programming</i> .

---

## F

<b>facility</b>	Equipment (often a <i>line/trunk</i> ) constituting a telecommunications path between the system and the telephone company central office ( <i>CO</i> ).
<b>Facility Restriction Level</b>	See <i>FRL</i> .
<b>factory setting</b>	Default state of a device or feature when an optional setting is not programmed by the user or system manager.
<b>fax</b>	(facsimile) Scanning and transmission of a graphic image over a telecommunications facility, or the resulting reproduced image, or the machine that does the scanning and transmitting.
<b>Fax Attendant System</b>	Fax handling and processing application available with <i>AUDIX Voice Power</i> .
<b>FCC</b>	(Federal Communications Commission)
<b>feature</b>	Function or service provided by the system.
<b>feature code</b>	Code entered on a dialpad to activate a feature.
<b>feature module</b>	Prior to Release 3.0, a circuit pack inserted into the <i>processor module</i> , used to provide system features and replaced when the system is upgraded.
<b>Feature screen</b>	Display screen on MLX display telephones; provides quick access to commonly used features.
<b>ferrite core</b>	Attachment to the AC power cord and ground wire of the carrier power supply for compliance with FCC, part 15 requirements.

<b>Flash ROM</b>	Beginning with Release 3.0, a type of read-only memory provided on the <i>processor module</i> , used to supply system features.
<b>foil shield</b>	Copper foil sheet (for power units) used to prevent excessive noise on the module.
<b>forced idle</b>	Condition of the system during certain programming or maintenance procedures; system prevents initiation of new calls.
<b>foreign exchange</b>	See <i>FX</i> .
<b>Fractional-T1</b>	A digital transmission facility consisting of at least one, and fewer than 24 <i>DS0</i> channels using robbed-bit signaling and connecting a <i>PBX</i> and a <i>central office</i> or toll office.
<b>frame</b>	One of several segments of an analog or digital signal that has a repetitive characteristic. For example, a <i>DS1</i> frame consists of a framing <i>bit</i> and 24 bytes, which equals 193 bits.
<b>framing format</b>	Pattern of <i>frames</i> used in transmissions.
<b>frequency generator</b>	See <i>ring generator</i> .
<b>FRL</b>	(Facility Restriction Level) Calling restriction type that restricts calls to certain specified <i>ARS</i> and <i>UDP</i> routes.
<b>FX</b>	(Foreign exchange) Central office ( <i>CO</i> ) other than the one that is providing local access to the public telephone network.

---

## G

<b>General Purpose Adapter</b>	See <i>GPA</i> .
<b>glare</b>	Condition that occurs when a user tries to call out on a <i>loop-start line</i> at the same time that another call arrives on the same line.
<b>GPA</b>	(General Purpose Adapter) Device that connects an analog multiline telephone to optional equipment such as an answering machine or a fax machine.
<b>ground-start trunk</b>	Trunk on which the communications system, after verifying that the trunk is idle (no ground on tip lead), transmits a request for service (puts ground on ring lead) to the telephone company central office ( <i>CO</i> ).
<b>Group IV (G4) fax machine</b>	A fax unit, offering 400 by 100 dots per inch (DPI) in fine mode, that can operate at any speed for communication with a Group III (G3) fax machine or another Group IV (G4) fax machine.

**group videoconferencing system** A system application that allows face-to-face, simultaneous video and voice communications between groups and requires high-speed data transmission facilities. See also *desktop videoconferencing system*.

## H

**Hands Free Answer on Intercom** See *HFAI*.

**hands-free unit** See *HFU*.

**headset** Lightweight earpiece and microphone used for hands-free telephone operation.

**HFAI** (Hands Free Answer on Intercom) Feature that allows a user to answer a voice-announced call.

**HFU** (Hands-Free Unit) Unit for analog multiline telephones that allows users to make and receive calls on the speakerphone without using the handset.

**Home screen** Display normally shown on an MLX display telephone; shows time, date, and call information, and shows when some features are in use.

**host** Telephone company or other switch providing features and services to the system users, usually when the system is operating in *Behind Switch mode*.

**hub system** In *private network* that is arranged in a *star configuration*, the communications system through which all calls across the network pass.

**Hybrid/PBX mode** One of three modes of system operation, in which the system uses line/trunk *pools* and *ARS* in addition to *personal lines*. Provides a single interface (**SA** buttons) to users for both internal and external calling. See also *Behind Switch mode* and *Key mode*.

## I

**ICLID** (Incoming Call Line Identification) See *Caller ID*.

**ICOM buttons** (intercom buttons) Telephone buttons that provide access to inside system lines for calling other extensions or receiving calls from them.

**immediate-start tie trunk** *Tie trunk* on which no start signal is necessary; dialing can begin immediately after the trunk is seized.

**in-band signaling** See *robbed-bit signaling*.

**inside dial tone** A tone users hear when they are off-hook on an **SA** or **ICOM** button.

<b>Inspect screen</b>	Display screen on an MLX display telephone that allows the user to preview incoming calls and see a list of the features programmed on line buttons.
<b>Integrated Administration</b>	Capability of <i>IS III</i> that simplifies the programming of common information for the system, <i>AUDIX Voice Power</i> , and, if it is also installed, <i>Fax Attendant System</i> .
<b>Integrated Services Digital Network</b>	See <i>ISDN</i> .
<b>Integrated Solution II/III</b>	See <i>IS II/III</i> .
<b>Integrated Voice Power Automated Attendant</b>	<i>IS II</i> application that automatically answers incoming calls with a recorded announcement and directs callers to a department, an extension, or the system operator.
<b>intercom buttons</b>	See <i>ICOM buttons</i> .
<b>interface</b>	Hardware and/or software that links systems, programs, or devices.
<b>intersystem calls</b>	In a <i>private network</i> , calls between a local extension and a <i>local or non-local dial plan</i> extension.
<b>Intuity CONVERSANT</b>	Voice response application that automatically answers and routes calls and executes telephone transactions.
<b>I/O device</b>	(input/output device) Equipment that can be attached to a computer internally or externally for managing a computer system's input and output of information.
<b>IROB protector</b>	(In-Range Out-of-Building protector) Surge-protection device for off-premises telephones at a location within 1000 feet (305 m) of cable distance from the control unit.
<b>IS II/III</b>	(Integrated Solution II or Integrated Solution III) Set of UNIX System-based applications that augments and provides additional services using the system.
<b>ISDN</b>	(Integrated Services Digital Network) Public or private network that provides end-to-end digital connectivity for all services to which users have access by a limited set of standard multipurpose user and <i>network interfaces</i> ; provides digital circuit-switched or packet-switched connections within the network and to other networks for national and international digital connectivity.
<b>ISDN 7500B Data Module</b>	Data communications device that allows connection between an RS-232 <i>DTE</i> device and the control unit by MLX extension jacks on the 008 MLX or 408 GS/LS-MLX module.
<b>ISDN terminal adapter</b>	(Integrated Services Digital Network terminal adapter) A device that connects the communications system with <i>data terminal equipment (DTE)</i> ; for example, an <i>ISDN terminal adapter</i> or <i>modem</i> acting as <i>data communications equipment (DCE)</i> for a PC.

---

**ISDN terminal adapter data station** A type of data station that includes an ISDN terminal adapter as its DCE. It may also include an MLX telephone for simultaneous voice and data (ISDN terminal adapter data-only station). These data stations connect to MLX extension jack modules for digital transmission of data over a DS1 facility.

---

## J

**jack** Physical connection point to the system for a telephone, line/trunk, or other device. Also called "port."

---

## K

**kbps** (kilobits per second)

**Key mode** One of three modes of system operation, in which the system uses personal lines on line buttons for outside calls, with a separate interface (**ICOM buttons**) for inside calling. See also *Behind Switch mode* and *Hybrid/PBX mode*.

---

## L

**LAN** (local area network) Arrangement of interconnected personal computers or terminals, sometimes accessing a host computer, sometimes sharing resources such as files and printers.

**LDN** (Listed Directory Number)

**LED** (light-emitting diode) Semiconductor device that produces light when voltage is applied; light on a telephone.

**line** Connection between extensions within the communications system; often, however, used synonymously with *trunk*.

**line and trunk assignment** Assignment of lines and trunks connected to the system control unit to specific buttons on each telephone.

**line coding** Pattern that data assumes as it is transmitted over a communications channel.

**line compensation** Adjustment for the amount of cable loss in decibels (dB), based on the length of cable between a 100D module and a channel service unit (*CSU*) or other far-end connection point.

**line/trunk** Refers to inside system lines and outside lines/trunks in general terms. See also *line* and *trunk*.



<b>line/trunk jack</b>	Physical interface on a module in the control unit for connecting an outside line/trunk to the communications system. Also called "trunk jack."
<b>line/trunk and extension module</b>	Module on which the jacks for connecting central office lines/trunks and/or the jacks for connecting the extensions are located.
<b>local dial plan</b>	In a system that is part of a <i>private network</i> , a list of extension ranges that the local system references in order to route local <i>intersystem calls via UDP</i> .
<b>local host computer access</b>	A method for connecting an extension jack to an on-site computer for data-only calls through a <i>modem</i> or <i>ISDN terminal adapter</i> .
<b>local loop</b>	The two-way connection between a customer's premises and the central office (CO).
<b>local user</b>	In a <i>private network</i> , a person whose extension is connected to the local control unit.
<b>logical ID</b>	Unique numeric identifier for each <i>extension</i> and <i>line/trunk jack</i> in the system control unit.
<b>loop-start line</b>	Line on which a closure between the tip and ring leads is used to originate or answer a call. High-voltage 20-Hz AC ringing current from the central office signals an incoming call.
<b>Lucent Technologies Attendant</b>	Application with equipment that connects to one or more <i>tip/ring</i> (T/R) extension jacks and automatically answers incoming calls with a recorded announcement; directs calls in response to touch tones.

---

## M

<b>Magic on Hold</b>	A Lucent Technologies Music On Hold enhancement that promotes a company's products or services.
<b>Mbps</b>	(megabits per second)
<b>Megacom</b>	The AT&T tariffed digital <i>WATS</i> offering for outward calling.
<b>Megacom 800</b>	The AT&T tariffed digital 800 offering for inward calling.
<b>memory card</b>	Storage medium, similar in function to a floppy disk, that allows information to be added to or obtained from the communications system through the PCMCIA interface slot on the processor module.
<b>MERLIN Identifier</b>	Adjunct that allows users to receive, store, and use information provided by Caller ID.
<b>MERLIN and MERLIN LEGEND MAIL Voice Messaging Systems</b>	Applications that provide automated attendant, call answering, and voice-mail services on the system.

<b>MFM</b>	(Multi-Function Module) Adapter that has a <i>tip/ring</i> mode for answering machines, modems, fax machines, and tip/ring alerts, and an <i>SAA</i> mode for -48 VDC alerts. It is installed inside an MLX telephone and is used to connect optional equipment to the telephone. The optional equipment and the telephone operate simultaneously and independently.
<b>MLX-5 or MLX-5D telephone</b>	5-line button digital telephone offered with (MLX-5D) or without (MLX-5) a 2-line by 24-character display.
<b>MLX-10, MLX-10D or MLX-10DP telephone</b>	10-line button digital telephone offered with (MLX-10D) or without (MLX-10) a 2-line by 24-character display. The MLX-10DP allows connection of <i>Passageway Direct Connection Solution</i> .
<b>MLX-16DP telephone</b>	16-line button digital telephone offered with a 2-line by 24-character display, allowing connection of <i>Passageway Direct Connection Solution</i> .
<b>MLX-20L telephone</b>	20-line button digital telephone with a 7-line by 24-character display.
<b>MLX-28D telephone</b>	28-line button digital telephone with a 2-line by 24-character display.
<b>mode codes</b>	Streams of touch-tone codes used by voice messaging applications to communicate with the system's control unit.
<b>modem</b>	Device that converts digital data signals to analog signals for transmission over a telephone line, and analog signals received on a telephone line to digital signals.
<b>modem data station</b>	A type of data station that includes a modem as its DCE. It may also include an MLX telephone for simultaneous voice and data (MLX voice and modem data station), an analog multiline telephone (analog voice and modem data station), or a single-line telephone for dialing only (modem data-only station). These data stations connect respectively to MLX, analog, or tip/ring extension jack modules. They provide analog transmission of data.
<b>modem pool</b>	Pair, or group of pairs, of <i>modems</i> and data modules with interconnected RS-232 interfaces that converts digital signals to analog, or analog signals to digital, thereby allowing users with <i>ISDN terminal adapter data stations</i> to communicate with users who have analog <i>modem data stations</i> .

<b>module</b>	Circuit pack in the control unit that provides the physical jacks for connection of telephones and/or outside lines/trunks to the communications system. In the name of a module, the first digit indicates the number of <i>line/trunk jacks</i> it contains; the last digit indicates the number of <i>extension jacks</i> it contains. If no letters appear after the number, a line/trunk module provides <i>loop-start lines</i> or an extension jack module provides analog or <i>tip/ring jacks</i> . For example, a 408 GS/LS MLX module contains four line/trunk jacks and eight digital (MLX) extension jacks, and provides either <i>loop-start (LS)</i> or <i>ground-start (GS) trunks</i> .
<b>monitored extension</b>	Extension for which one or more CTI applications is receiving call information. The CTI application does not have to be directly attached to the equipment at the extension in order to monitor calls. The call information may appear on the PC screen of another extension that has been programmed to receive it. See also <i>CTI link</i> and <i>unmonitored extension</i> .
<b>Multi-Function Module</b>	See <i>MFM</i> .
<b>multiline telephone</b>	An analog or digital (MLX) telephone that provides multiple line buttons for making or receiving calls or programming features.
<b>multiplexing</b>	The division of a transmission channel into two or more independent channels, either by splitting the frequency band into a number of narrower bands or by dividing the channel into successive time slots.
<b>Music On Hold</b>	Customer-provided music source or Magic on Hold connected to the system through a <i>loop-start</i> jack.

---

## N

<b>network</b>	Configuration of communications devices and software connected for information interchange.
<b>network interface</b>	Hardware, software, or both that links two systems in an interconnected group of systems, for example, between the local telephone company and a PBX.
<b>NI-1 BRI</b>	(National Integrated Services Digital Network 1 Basic Rate Interface) A type of digital facility that carries the equivalent of three lines. Two are called <i>B-channels</i> and provide voice and data communications services. A third <i>D-channel</i> controls signaling and maintains operations on the B-channels.
<b>non-local user</b>	In a <i>private network</i> , a user who is connected to another system in the network and not to the local system.
<b>non-local dial plan</b>	In a system that is part of a <i>private network</i> , a list of extension ranges that the local system references in order to route non-local <i>intersystem calls via UDP</i> .
<b>non-satellite system</b>	In a <i>private network</i> , a <i>communications system</i> that is directly connected to and located more than 200 miles from the local system.

---

## O

<b>off-hook</b>	Telephone is said to be off-hook when the user has lifted the handset, pressed the <b>Speakerphone</b> button to turn on the speakerphone, or used a headset to connect to the communications system or the telephone network.
<b>off-premises telephone</b>	See <i>OPT</i> .
<b>ones density</b>	Requirement for channelized <i>DS1</i> service to the public network that eight consecutive zeros cannot occur in a digital data stream.
<b>on-hook</b>	Telephone is said to be on-hook when the handset is hung up, the speakerphone is turned off, and the user is not using a headset to connect to the communications system or the telephone network.
<b>OPT</b>	(off-premises telephone) <i>Single-line telephone</i> or other <i>tip/ring</i> device connected to the system via a 008 OPT module in the control unit. Appears as an inside extension to the system, but may be physically located away from the system.
<b>OPX</b>	(off-premises extension)

**out-of-band signaling** Signaling that uses the same path as voice-frequency transmission and in which the signaling is outside the band used for voice frequencies.

---

**P**

**parity** The addition of a *bit* to a bit string so that the total number of ones is odd or even, used to detect and correct transmission errors.

**PassageWay Direct Connection Solution** Set of software applications that provides an interface between a personal computer and an MLX telephone.

**PBX** (private branch exchange) Local electronic telephone switch that serves local stations (for example, extensions within a business) and provides them with access to the public network.

**PC** personal computer

**PCMCIA memory card** (Personal Computer Memory Card International Association memory card) See *memory card*.

**peripheral system** In a *private network*, a system that does not connect to more than one other system, sometimes called an "end node."

**personal line** Central office line/trunk that terminates directly at one or more extensions. In *Hybrid/PBX mode*, a personal line cannot be part of a line/trunk *pool*. Also called "DFT" (direct facility termination).

**PFT** (Power Failure Transfer) Feature that provides continuity of telephone service during a commercial power failure by switching some of the system's line/trunk connections to telephones connected to specially designated extension jacks.

**phantom extension** An extension that is not actually plugged into the system but is used, for example, as a calling group member covered by a *voice messaging system*.

**pool** In *Hybrid/PBX mode*, a group of outside lines/trunks that users can access with a **Pool** button or by dialing an access code on an **SA** button. Also used by the *ARS* feature when choosing the least expensive route for a call.

**point-to-point facility** In a *private network*, a line/trunk that passes through the *PSTN* without using the switching capabilities of the *PSTN*.

**port** See *jack*. Also, refers to *extension* or *line/trunk jacks* before these are numbered according to the *dial plan* during programming. The lowest jack on a module is always Port 1.

**Power Failure Transfer** See *PFT*.

<b>power supply module</b>	Device that directs electricity to modules and telephones on the system. One power supply module is needed for each carrier, and an <i>auxiliary power unit</i> is added if needed.
<b>PRI</b>	(Primary Rate Interface) Standard interface that specifies the protocol used between two or more communications systems. As used in North America, it provides twenty-three 64-kbps <i>B-channels</i> for voice and/or data and one 16-kbps <i>D-channel</i> , which carries multiplexed signaling information for the other 23 channels.
<b>primary system operator position</b>	First jack on the first MLX or analog multiline extension module in the control unit, that is, the extension jack with the lowest logical ID in the system.
<b>prime line</b>	Individual extension number assigned to a telephone in a system operating in <i>Behind Switch mode</i> . Each telephone user has his or her own prime line and is automatically connected to that line when he or she lifts the handset.
<b>private communications network or private network</b>	An interconnected group of <i>communications systems</i> , which may consist of MERLIN LEGEND Communications Systems, DEFINITY Enterprise Communications Servers (ECS), and/or DEFINITY ProLogix Solutions.
<b>private network trunks</b>	The facilities that connect <i>communications systems</i> in a <i>private network</i> . See also <i>tandem tie trunks</i> and <i>tandem PRI trunks</i> .
<b>processor module</b>	Module in the second slot of the control unit (Slot 0, to the right of the <i>power supply module</i> ). Includes the software and memory that runs the system.
<b>programming port reassignment</b>	Reassignment of the system programming jack position to any of the first five extension jacks on the first MLX module in the control unit.
<b>protocol</b>	Set of conventions governing the format and timing of message exchanges between devices, such as an MLX telephone and the control unit.
<b>PSTN</b>	Network that is commonly accessible for local or long-distance calling. Also called "public network" or "public switched network."
<b>PSTN trunk</b>	In a <i>private network</i> , a facility that connects a networked system to the public switched telephone network.
<b>public switched telephone network</b>	See <i>PSTN</i> .

---

## Q

**QCC** (Queued Call Console) MLX-20L telephone used by a system operator in *Hybrid/PBX mode* only. Used to answer outside calls (directed to a system operator position) and inside calls, direct inside and outside calls to an extension or an outside telephone number, serve as a message center, make outside calls for users with outward calling restrictions, set up conference calls, and monitor system operation.

---

## R

**RAM** (random-access memory) Computer memory in which an individual *byte* or range of bytes can be addressed and read or changed without affecting other parts of memory.

**read-only memory** See *ROM*.

**Remote Access** System feature that allows an outside caller to gain access to the system, almost as if at a system extension. In a *private network*, remote access settings are used to control calls routed via *ARS* or *UDP* routing across the network.

**restore** Procedure whereby saved and archived system programming is reinstated on the system, from a floppy disk or *memory card*. See also *backup*.

**restricted data channel** Restricted data channels do not allow the transmission of occurrences of more than seven contiguous zero bits. See also unrestricted data channel.

**ring generator** Circuit pack added to the power supply that generates a high-voltage, 20–30 Hz signal to ring a telephone.

**riser cable** Cable that runs between floors in a multistory building and connects wiring closets.

**RS-232** Physical interface, specified by the Electronics Industries Association (EIA), that transmits and receives asynchronous data at distances of up to 50 feet (15 m).

**robbed-bit signaling** Signaling in which the least significant *bit* of every sixth frame per channel is used for signaling in that channel.

**ROM** (read-only memory) Computer memory that can be read but cannot be changed.

---

## S

<b>SAA</b>	(Supplemental Alert Adapter) Device that permits alerting equipment to be connected to an analog multiline telephone jack so that people working in noisy or remote areas of a building can be alerted to incoming calls.
<b>SA buttons</b>	Telephone buttons that provide access to both inside and outside calls.
<b>satellite system</b>	In a <i>private network</i> , a <i>communications system</i> that is directly connected to and located within 200 miles of the local system.
<b>screen pop</b>	Refers to a computer-telephony software application that takes caller information (for example, provided by Caller ID service), queries a database, and displays a screen with information about the caller onto a user's PC screen. Screen pop requires that an identifying number or code be available to identify the calling party. See also <i>CTI link</i> .
<b>SDN</b>	(Software Defined Network) AT&T private networking service created by specialized software within the public network.
<b>series configuration</b>	A <i>private network</i> arrangement where either two or four or more communications systems are connected in a line, with no particular system acting as the <i>hub system</i> . See also <i>star configuration</i> .
<b>SID</b>	[station (extension) identification]
<b>signaling</b>	Sending of information between devices to set up, maintain, or cease a connection such as a telephone call.
<b>simplex signaling</b>	Transmission of signals in one direction only across a telecommunications channel.
<b>single-line telephone</b>	Industry-standard touch-tone or rotary-dial telephone that handles one call at a time and is connected to the system via an <i>extension jack</i> on a 012, 016, or 008 OPT module.
<b>slot</b>	Position in a <i>carrier</i> for a module; numbered from 0.
<b>SMDR</b>	(Station Message Detail Recording) Feature that captures usage information on incoming and outgoing calls.
<b>SMDR printer</b>	Printer used to produce SMDR reports. Connected to the system via an RS-232 jack on the <i>processor module</i> .
<b>Software Defined Network</b>	See <i>SDN</i> .
<b>special character</b>	Pause, Stop, or End-of-Dialing signal in a programmed dialing sequence such as a speed dial number.
<b>SPM</b>	(System Programming and Maintenance) DOS- or UNIX System-based application for programming the system.
<b>square key</b>	Configuration in <i>Key mode</i> operation in which all outside lines appear on all telephones.



<b>star configuration</b>	A <i>private network</i> arrangement where either three or more communications systems are connected with one system acting as the <i>hub system</i> . See also <i>series configuration</i> .
<b>station</b>	See <i>extension</i> .
<b>station jack</b>	See <i>extension jack</i> .
<b>Station Message Detail Recording</b>	See <i>SMDR</i> .
<b>Supplemental Alert Adapter</b>	See <i>SAA</i> .
<b>switch</b>	See <i>communications system</i> .
<b>Switched 56 service</b>	DS1 Switched 56 Service is an end-to-end digital, 56-kbps, full duplex, synchronous, circuit-switched service offering. The service is offered by network service providers and by some Local Exchange Carriers (LECs) as circuit-switched, 56-kbps service. T1-emulated tandem tie trunks in a private network can be programmed for data.
<b>switchhook flash</b>	Momentary (320 ms to 1 second) on-hook signal used as a control; may be directed to the control unit or to a <i>host</i> switch outside the system. Also called "Recall" or "timed flash."
<b>switch identifier</b>	A number assigned to a <i>tandem trunk</i> in a <i>private network</i> . It identifies the system connected to the far end of the trunk. Switch identifiers are based on the type of system and its distance from the system where the identifier is assigned. See also <i>satellite system</i> and <i>non-satellite system</i> .
<b>synchronous data transmission</b>	Method of transmitting a continuous digital data stream in which the transmission of each binary <i>bit</i> is synchronized with a master clock. See also <i>asynchronous data transmission</i> .
<b>system acceptance test</b>	Test of all trunks, telephones, data terminals, and features after installation to ensure that they are working correctly.
<b>System Access buttons</b>	See <b>SA</b> buttons.
<b>system date and time</b>	Date and time that appear on MLX display telephones and <i>SMDR</i> reports.
<b>system programming</b>	Programming of system functions and features that affect most users, performed from an MLX-20L telephone or a computer using <i>SPM</i> . See also <i>extension programming</i> and <i>centralized telephone programming</i> .
<b>System Programming and Maintenance</b>	See <i>SPM</i> .
<b>system renumbering</b>	Procedure used to change the numbers assigned to telephones, adjuncts, <i>calling groups</i> , paging groups, park zones, <i>Remote Access</i> , and lines/trunks.

## T

<b>T1</b>	Type of digital transmission facility that in North America transmits at the <i>DS1</i> rate of 1.544 Mbps.
<b>T1-emulated data</b>	A T1 tie trunk programmed for S56DATA for use by data calls at speeds up to 56 kbps. These trunks may be used for tandem and non-tandem operation.
<b>T1-emulated voice</b>	A T1 tie trunk programmed for Tie-PBX or Tie-Toll for use by voice calls.
<b>T1 Switched 56 service</b>	<i>T1</i> digital data transmission over the <i>public network</i> or over a <i>private network</i> at 56 kbps. See <i>Switched 56 service</i> .
<b>tandem switching</b>	The capability of <i>private network</i> communications systems that allows them to direct outside calls from one facility to another facility, rather than just to an extension. Calls may be sent, for example, from a <i>PSTN</i> facility to a <i>tandem trunk</i> or vice versa.
<b>tandem trunk</b>	An private outside facility (as opposed to an inside system line) that connects two communications systems in a <i>private network</i> and can carry calls to another outside facility through <i>tandem switching</i> . The trunk is not connected to the <i>PSTN</i> .
<b>tandem tie trunk</b>	A <i>tandem trunk</i> that is an analog <i>delay-start tie trunk</i> , providing a single line/trunk per facility and allowing <i>analog transmission</i> of voice and low-speed data. Or a T1 facility offering 24 channels on emulated tie trunks and programmed for voice or data
<b>tandem PRI trunk</b>	(tandem Primary Rate Interface trunk) A private network trunk.
<b>TAPI</b>	Telephony Application Programming Interface. An application programming interface that allows computer telephony applications to be used. TAPI is not yet supported by the MERLIN LEGEND Communications System. See also <i>TAPI</i> , <i>CTI</i>
<b>telephone power supply unit</b>	Equipment that provides power to an individual telephone.
<b>terminal adapter</b>	See <i>ISDN terminal adapter</i> .
<b>tie trunk</b>	Private trunk directly connecting two telephone switches.
<b>timed flash</b>	See <i>switchhook flash</i> .
<b>tip/ring</b>	Contacts and associated conductors of a <i>single-line telephone</i> plug or jack.
<b>touch-tone receiver</b>	See <i>TTR</i> .
<b>T/R</b>	See <i>tip/ring</i> .

<b>trunk</b>	Telecommunications path between the communications system and the telephone company central office (CO) or another switch. Often used synonymously with <i>line</i> .
<b>trunk jack</b>	See <i>line/trunk jack</i> .
<b>trunk pool</b>	See <i>pool</i> .
<b>TSAPI</b>	Telephony Services Application Programming Interface. An application programming interface that allows computer telephony applications to be used. TSAPI is supported by the MERLIN LEGEND Communications System Release 5.0. See also <i>TAPI</i> , <i>CTI</i> .
<b>TTR</b>	(touch-tone receiver) Device used to decode <i>DTMF</i> touch-tones dialed from <i>single-line</i> or <i>Remote Access</i> telephones.

---

## U

<b>UDP</b>	(Uniform Dial Plan) Composed of the <i>local dial plan</i> and <i>non-local dial plan</i> . A dial plan that allows a caller at any extension in a <i>private network</i> to dial the same number of digits to reach any other extension in the private network, even if the originating extension is physically connected to one communications system and the terminating extension is physically connected to a different communications system.
<b>unambiguous numbering</b>	The practice of numbering of extension ranges, remote access codes, or other system components to avoid routing conflicts in network or local calling. For example, Extension 441 is unique when compared to Extension 4410. However it is ambiguous, because a system routes as soon as it matches the digits sent for a call with the digits in a local plan or in a non-local dial plan extension range. When a caller dials <i>4410</i> , a system routes the call to Extension 441 immediately, without considering the last dialed digit.
<b>Uniform Dial Plan</b>	See <i>UDP</i> .
<b>uninterruptible power supply</b>	See <i>UPS</i> .
<b>unit load</b>	Measure of the power load drain of a module, telephone, or <i>adjunct</i> .
<b>unmonitored extension</b>	An extension for which no CTI application is receiving call information. See also <i>CTI link</i> and <i>monitored extension</i> .
<b>unrestricted data channel</b>	Unrestricted data channels (also called clear data channels) allow the transmission of occurrences of more than seven contiguous zero bits. If an unrestricted data channel is requested and only restricted channels are available, the call will be rejected. See also <i>restricted data channel</i> .

**UPS** (uninterruptible power supply) Device that connects to the system to provide 117 VAC to the equipment when the commercial power source fails.

---

**V**

**VAC** (alternating-current voltage)

**VDC** (direct-current voltage)

**VMI** (voice messaging interface) An enhanced *tip/ring* port.

**videoconferencing system** System application that allows face-to-face meetings, with voice and video, to occur between individuals or groups. This application requires high-speed data transmission facilities. See also *desktop videoconferencing* and *group videoconferencing*.

**virtual private network** See *VPN*.

**VPN** (virtual private network) A type of *private network* that uses the switching capabilities of the *PSTN*, rather than *tandem switching*, to direct calls between connected communications systems. A VPN may constitute a part of a private network.

**voice-band channel** A transmission channel, generally in the 300–3400-Hz frequency band.

**voice mail** Application that allows users to send messages to other system extensions, forward messages received with comments, and reply to messages.

**voice messaging interface** See *VMI*.

---

**W**

**WATS** (Wide Area Telecommunications Service) Service that allows calls to certain areas for a flat-rate charge based on expected usage.

**wink-start tie trunk** *Tie trunk* on which the originating end transmits an off-hook signal and waits for the remote end to send back a signal (a wink) that it is ready for transmission.

# Index

---

## Numerics

- 008 OPT modules, [D-4](#)
  - 012 T/R modules
    - touch-tone receivers (TTRs), [D-4](#)
  - 016 T/R modules
    - touch-tone receivers (TTRs), [D-4](#)
  - 100D module
    - clock source, [5-6](#), [6-25](#)
  - 2B data
    - troubleshooting, [6-25](#)
  - 400 GS/LS modules, [D-4](#)
  - 800 DID modules, [D-4](#)
  - 800 LS-ID modules, [D-4](#)
- 

## A

- Access to Disallowed Lists Report, [B-19](#)
  - Account Code Entry
    - feature interactions, [3-1](#)
  - Alarm
    - feature interactions, [3-1](#)
  - Allowed/Disallowed Lists, [6-19](#)
    - feature interactions, [3-2](#)
    - security, [4-4](#), [4-9](#)
  - Alternate mark inversion (AMI) line coding, [5-22](#)
  - Authorization Code
    - feature interactions, [3-2](#)
  - Auto Answer All
    - feature interactions, [3-2](#)
  - Auto Answer Intercom
    - feature interactions, [3-2](#)
  - Auto Dial
    - feature interactions, [3-2](#)
  - Automatic Route Selection (ARS)
    - calls blocked, [6-19](#)
    - calls go to operator, [6-24](#)
    - feature interactions, [3-3](#) to [3-4](#)
    - programming, [5-3](#)
    - restrictions, [5-5](#)
    - scenarios, [2-7](#)
  - Automatic Route Selection Report, [B-20](#)
- 

## B

- Barge-In
  - feature interactions, [3-4](#)
- Barrier codes, [4-7](#)

- Basic Rate Interface (BRI)
    - clock source, [5-7](#)
  - B-channels, [5-23](#)
  - Benefits
    - improved efficiency, [1-5](#)
    - service cost savings, [1-4](#)
    - toll saving, [1-4](#)
  - Bipolar 8 zero substitution (B8ZS) line coding, [5-22](#)
  - Busy tone
    - troubleshooting, [6-5](#), [6-11](#)
- 

## C

- Call reaches wrong extension, [6-14](#)
- Call volume
  - troubleshooting, [6-20](#)
- Callback, [4-8](#), [5-6](#), [6-5](#), [6-7](#)
  - feature interactions, [3-4](#)
  - security, [4-9](#)
  - troubleshooting, [6-20](#)
- Caller ID
  - feature interactions, [3-5](#)
- Calling restrictions
  - feature interactions, [3-5](#)
  - security, [4-3](#)
- Calls do not reach centralized VMS/AA
  - troubleshooting, [6-26](#)
- Calls go to operator, [6-24](#)
- Calls to centralized VMS/AA get wrong message
  - troubleshooting, [6-29](#)
- Camp-On
  - feature interactions, [3-6](#)
- Centralized Voice Messaging
  - configuration requirements, [1-21](#)
  - example, [1-23](#)
  - feature interactions, [3-6](#) to [3-7](#)
  - implementation, [1-23](#)
  - introduction, [1-21](#)
  - networking voice messaging systems, [1-26](#)
  - tandem facilities, [1-22](#)
- Class-of-restriction settings, [4-6](#)
- Class-of-restriction settings, [see also](#) Remote access
- Clock source
  - troubleshooting, [6-25](#)
- Clock synchronization
  - DEFINITY Enterprise Communications Server (ECS) and DEFINITY ProLogix Solutions, [5-8](#)
  - programming, [5-6](#)
  - troubleshooting, [6-25](#)
- Computer Telephony Integration (CTI) link
  - feature interactions, [3-7](#) to [3-8](#)
  - transfers, [6-15](#)
- Computer Telephony Integration (CTI) link, [see also](#) PassageWay Telephony Services clients
- Conference
  - feature interactions, [3-8](#)
  - troubleshooting, [6-17](#)
- Configuration requirements
  - centralized voice messaging system, [1-21](#)

Considerations for voice messaging, [C-3](#)  
  Intuity AUDIX, [C-2](#)  
  MERLIN LEGEND Mail, [C-2](#)  
  Messaging 2000, [C-3](#)  
Copy Telephone Number to Send setting, [5-24](#)  
Coverage, [D-5](#)  
  feature interactions, [3-9](#)  
  troubleshooting, [6-13](#)  
CTI link, see Computer Telephony Integration (CTI) link

---

## D

D4 framing, [5-22](#)  
D-channels, [5-22](#)  
DEFINITY Enterprise Communications Server (ECS) and DEFINITY ProLogix Solutions  
  clock synchronization, [5-8](#)  
  digit manipulation, [5-28](#)  
  Direct Inward Dialing (DID), [5-9](#)  
  non-local Uniform Dial Plan (UDP), [5-16](#)  
  switch identifiers, [5-20](#)  
  switch type, [5-24](#)  
Delay announcement devices, [D-1](#)  
Dial Plan Report, [B-6](#)  
Dial tone, [D-1](#)  
DID Trunk Information Report, [B-11](#)  
DID, see Direct Inward Dialing (DID)  
Digit absorption, [5-4](#), [5-27](#)  
Digital data calls, [6-11](#)  
  feature interactions, [3-9](#)  
Digital data calls, see also 2B data  
Direct Group Calling Information Report  
  (Local Members Only), [B-24](#)  
  (Single Non-Local Member), [B-25](#)  
Direct Inward Dialing (DID)  
  DEFINITY Enterprise Communications Server (ECS) and DEFINITY ProLogix Solutions, [5-9](#)  
  programming, [5-9](#)  
  remote access, [4-6](#)  
  routing, [6-24](#)  
  troubleshooting, [6-17](#)  
Direct Station Selector (DSS)  
  feature interactions, [3-10](#)  
Direct Voice Mail  
  feature interactions, [3-10](#)  
Direct-Line Console (DLC)  
  feature interactions, [3-10](#)  
Directories  
  feature interactions, [3-10](#)  
Disallowed Lists Report, [B-19](#)  
Disallowed Lists, see Allowed/Disallowed Lists  
Display  
  feature interactions, [3-11](#) to [3-12](#)  
  troubleshooting, [6-22](#)  
Display preference, [5-31](#), [6-22](#)  
Do Not Disturb  
  feature interactions, [3-12](#)  
Drop-and-insert equipment, [5-22](#)  
DS1 Information Report, [B-13](#)

---

## E

- Efficiency, [1-5](#)
  - Error Log Report, [B-26](#)
  - Extended Station Status
    - feature interaction, [3-12](#)
  - Extended superframe (ESF) format, [5-22](#)
  - Extension Directory Report, [B-21](#)
  - Extension Information Report, [B-22](#)
  - Extension ranges, see Non-local Uniform Dial Plan (UDP)
  - Extension Status
    - security, [4-4](#)
- 

## F

- Facilities planning
    - scenario, [2-20](#), [2-44](#), [2-59](#), [2-76](#), [2-90](#)
  - Facility Restriction Levels (FRLs)
    - extensions, [5-4](#)
    - overview, [4-5](#)
    - planning, [4-9](#)
    - remote access, [4-6](#)
    - routes, [5-26](#)
    - troubleshooting, [6-8](#), [6-10](#), [6-11](#), [6-12](#), [6-18](#), [6-19](#)
  - Fax Messaging in a Centralized Voice Mail Configuration, [C-4](#)
  - Feature interactions, [3-1](#) to [3-28](#)
  - Forced Account Code Entry
    - feature interactions, [3-1](#)
  - Forced-idle condition, [5-17](#)
  - Forward and Follow Me
    - feature interactions, [3-13](#)
  - fractional T1, [5-9](#)
- 

## G

- General Trunk Information Report, [B-12](#)
  - Group Calling
    - feature interactions, [3-13](#) to [3-15](#)
- 

## H

- Hands-Free Answer on Intercom (HFAI)
  - feature interactions, [3-15](#)
- HotLine
  - feature interactions, [3-16](#)



---

## I

### Implementation

centralized voice messaging system, [1-23](#)

Interexchange (IXC) calls, [5-2](#)

### Intersystem calling

call reaches wrong extension, [6-14](#)

display preference programming, [5-31](#)

feature interactions, [3-1](#) to [3-28](#)

scenario, [2-29](#), [2-54](#), [2-70](#), [2-96](#)

transferring calls, [3-26](#), [6-15](#)

### Intuity AUDIX

considerations for voice messaging, [C-2](#)

### IS-III AUDIX Voice Power

considerations for voice messaging, [C-3](#)

---

## L

### Labeling

feature interactions, [3-16](#)

Line noise, [6-25](#)

### Lines and trunks

introduction, [1-10](#)

### Loop-start lines

reliable disconnect, [6-16](#)

---

## M

### MERLIN LEGEND Mail

considerations for voice messaging, [C-2](#)

module, [D-4](#)

### MERLIN LEGEND system

considerations for voice messaging, [C-2](#)

Message from central office, [6-15](#)

### Message Waiting lights

troubleshooting, [6-30](#)

### Messaging

feature interactions, [3-16](#)

### Messaging 2000

considerations for voice messaging, [C-3](#)

MLX display telephones, see Display, Display preference

### Modules

supplying touch-tone receivers (TTRs), [D-4](#)

### Music On Hold

feature interactions, [3-17](#)

---

## N

- Network configuration
    - introduction, [1-8](#)
    - sample, [1-8](#)
    - scenarios, [2-14](#)
  - Network planning
    - scenario, [2-44](#)
  - Network service, [5-23](#)
  - Networking
    - benefits, [1-4](#)
  - Networking concepts
    - introduction, [1-2](#)
  - Networking guidelines
    - scenarios, [2-2](#)
  - Networking voice messaging systems
    - Centralized voice messaging system, [1-26](#)
  - Night Service
    - feature interactions, [3-17](#)
    - security, [4-4](#)
  - Non-local dial plan
    - scenario, [2-20](#), [2-44](#), [2-59](#), [2-76](#), [2-90](#)
    - scenarios, [2-2](#)
  - Non-Local Dial Plan Report, [B-9](#)
  - Non-local Uniform Dial Plan (UDP)
    - Facility Restriction Levels (FRLs), [5-4](#)
    - programming, [5-15](#)
    - troubleshooting, [6-11](#), [6-14](#)
  - Non-local Uniform Dial Plan (UDP) routing
    - programming, [5-25](#)
    - troubleshooting, [6-15](#)
- 

## O

- Operator hears tones
    - troubleshooting, [6-26](#)
  - Other digits, [5-4](#), [5-28](#)
- 

## P

- Paging
  - feature interactions, [3-17](#)
- Park
  - feature interactions, [3-18](#)
- PassageWay Telephony Services clients
  - conference, [6-17](#)
  - feature interactions, [3-7](#) to [3-8](#)
  - transfer, [6-15](#)
  - troubleshooting, [6-23](#)
- Personal lines
  - feature interactions, [3-18](#)
  - security, [4-3](#)

- Pickup
    - feature interactions, [3-18](#)
  - Pools, [5-2](#)
    - feature interactions, [3-18](#)
    - security, [4-3](#)
  - Power failure, [6-6](#), [6-26](#), [6-30](#)
  - PRI Information Report, [B-14](#)
  - Primary Rate Interface (PRI)
    - dial-plan routing, [4-6](#), [6-24](#)
    - feature interactions, [3-19](#)
    - programming, [5-23](#)
    - remote access, [4-6](#)
    - switch type, [5-23](#)
    - troubleshooting, [6-24](#)
  - print menu option, [B-2](#)
  - Private communications network
    - definition, [1-2](#)
  - Problems, see Troubleshooting
  - Programming
    - Automatic Route Selection (ARS), [5-3](#)
    - clock synchronization, [5-6](#)
    - Direct Inward Dialing (DID), [5-9](#)
    - display preference, [5-31](#)
    - non-local Uniform Dial Plan (UDP), [5-15](#)
    - non-local Uniform Dial Plan (UDP) routing, [5-25](#)
    - remote access, [5-5](#)
    - switch identifiers, [5-19](#)
    - tandem PRI trunks, [5-22](#)
    - tandem tie trunks, [5-9](#)
  - Prompt-Based Overflow setting, [D-1](#)
- 

## Q

- Queued Call Console (QCC)
    - feature interactions, [3-20](#)
- 

## R

- Reminder Service
  - feature interactions, [3-20](#)
- Remote Access
  - scenarios, [2-8](#)
- Remote access
  - barrier codes, [4-6](#), [5-15](#)
  - class-of-restriction settings, [4-6](#)
  - Facility Restriction Levels (FRLs), [4-6](#)
  - feature interactions, [3-21](#) to [3-22](#)
  - Primary Rate Interface (PRI), [4-6](#)
  - programming, [5-5](#)
  - security, [4-3](#)
- Remote Access (DISA) Information Report, [B-18](#)

## Report

- Access to Disallowed List, [B-19](#)
- Automatic Route Selection, [B-20](#)
- Dial Plan, [B-6](#)
- DID Trunk Information, [B-11](#)
- Direct Group Calling Information
  - (Local Members Only), [B-24](#)
  - (Single Non-Local Member), [B-25](#)
- Disallowed Lists, [B-19](#)
- DS1 Information, [B-13](#)
- Error Log, [B-26](#)
- Extension Directory, [B-21](#)
- Extension Information, [B-22](#)
- General Trunk Information, [B-12](#)
- Non-Local Dial Plan, [B-9](#)
- PRI Information, [B-14](#)
- Remote Access (DISA) Information, [B-18](#)
- Switch 56 Data Information, [B-27](#)
- Tie Trunk Information, [B-10](#)

## Reports, [6-2](#)

- print menu option, [B-2](#)
- sample, [B-1](#)

## Route Directly to UDP setting, [5-23](#)

## Routing outside calls

- programming, [5-3](#), [5-9](#)
- restrictions, [5-5](#)
- scenario, [2-26](#), [2-51](#), [2-67](#), [2-85](#), [2-94](#)
- security, [4-5](#)

---

## S

## Satellite system, [5-19](#)

## Scenario

- facilities planning, [2-20](#), [2-44](#), [2-59](#), [2-76](#), [2-90](#)
- Four Systems in a Series, Mixed Facilities, [2-57](#)
- Four Systems in a Star, Mixed Facilities, [2-74](#)
- intersystem calling, [2-29](#), [2-54](#), [2-70](#), [2-96](#)
- Large System Hub, [2-88](#)
- network planning, [2-44](#)
- non-local dial plan, [2-20](#), [2-44](#), [2-59](#), [2-76](#), [2-90](#)
- routing outside calls, [2-26](#), [2-51](#), [2-67](#), [2-85](#), [2-94](#)
- two systems, tandem PRI facilities, [2-16](#)
- two systems, tandem tie facilities, [2-32](#)

## Scenarios

- Automatic Route Selection (ARS), [2-7](#)
- network configuration, [2-14](#)
- networking guidelines, [2-2](#)
- non-local dial plan, [2-2](#)
- Remote Access, [2-8](#)
- security, [2-12](#)
- tandem trunks, [2-10](#)

- Security
    - Allowed/Disallowed Lists, [4-4](#), [4-9](#)
    - callback, [4-9](#)
    - calling restrictions, [4-3](#)
    - Extension Status, [4-4](#)
    - Night Service, [4-4](#)
    - overview, [4-2](#)
    - Personal Lines, [4-3](#)
    - planning, [4-1](#)
    - Pools, [4-3](#)
    - Remote Access, [4-3](#)
    - routing outside calls, [4-5](#)
    - scenarios, [2-12](#)
    - transfer, trunk-to-trunk, [4-3](#)
    - trunk-to-trunk transfer, [4-3](#)
  - Series configuration
    - illustration, [1-7](#)
  - Service cost savings, [1-4](#)
  - Service Observing
    - feature interactions, [3-22](#)
  - Signal/Notify
    - feature interactions, [3-22](#)
  - Speed Dial
    - feature interactions, [3-25](#)
  - Star configuration
    - illustration, [1-8](#), [1-9](#), [1-14](#), [1-16](#)
  - Station Message Detail Recording (SMDR)
    - feature interactions, [3-23](#) to [3-25](#)
    - troubleshooting, [6-25](#)
  - Switch 56 Data Information Report, [B-27](#)
  - Switch identifiers
    - DEFINITY Enterprise Communications Server (ECS) and DEFINITY ProLogix Solutions, [5-20](#)
    - programming, [5-19](#)
    - troubleshooting, [6-9](#), [6-19](#), [6-20](#), [6-29](#)
  - Switch type
    - programming, [5-23](#)
    - troubleshooting, [6-9](#), [6-10](#), [6-28](#)
  - System date and time, [5-8](#)
  - System forms, [6-2](#)
  - System programming, see Programming
  - System Renumbering
    - feature interactions, [3-26](#)
  - System reports, see Reports
- 

## T

- T1
  - feature interactions, [3-19](#)
  - fractional use, [5-9](#)
  - ordering, [5-22](#)
  - programming, [5-9](#)
- Tandem facilities
  - centralized voice messaging system, [1-22](#)

- Tandem PRI trunks
  - ordering circuit for, [5-22](#)
  - pools, [5-26](#)
  - programming, [5-6](#), [5-22](#)
  - troubleshooting, [6-9](#), [6-10](#), [6-28](#)
  - voice and/or data service, [5-29](#)
- Tandem switching
  - definition, [1-3](#)
  - introduction, [1-6](#)
- Tandem tie trunks
  - programming, [5-9](#)
  - troubleshooting, [6-6](#), [6-26](#), [6-29](#), [6-30](#)
- Tandem trunking
  - introduction, [1-6](#)
- Tandem Trunks
  - scenarios, [2-10](#)
- Tandem trunks
  - definition, [1-3](#)
  - identifying systems connected to far end, [5-19](#)
  - pools, [5-2](#), [5-25](#)
  - PRI versus tie, [1-11](#)
- Tie Trunk Information Report, [B-10](#)
- Toll Savings, [1-4](#)
- Touch-tone receivers (TTRs)
  - 008 OPT modules, [D-4](#)
  - 400 GS/LS modules, [D-4](#)
  - 800 DID modules, [D-4](#)
  - 800 LS-ID modules, [D-4](#)
  - calculating system requirements, [D-1](#)
  - required by voice mail/auto attendant, [D-1](#)
- Transfer
  - Computer Telephony Integration (CTI) link, [6-15](#)
  - feature interactions, [3-26](#) to [3-27](#)
  - incomplete, [6-15](#)
  - troubleshooting, [6-15](#)
- Transfer not returning
  - troubleshooting, [6-16](#)
- Transfer, trunk-to-trunk
  - security, [4-3](#)
- Transferring calls, [3-26](#)
- Troubleshooting
  - 2B data, [6-25](#)
  - Automatic Route Selection (ARS), [6-24](#)
  - busy tone, [6-5](#), [6-11](#)
  - call volume, [6-20](#)
  - Callback, [6-20](#)
  - clock synchronization, [6-25](#)
  - Conference feature, [6-17](#)
  - Coverage features, [6-13](#)
  - Direct Inward Dialing (DID), [6-17](#), [6-24](#)
  - display, [6-22](#)
  - Facility Restriction Levels (FRLs), [6-8](#), [6-10](#), [6-11](#), [6-12](#), [6-18](#), [6-19](#)
  - intersystem calling, [6-5](#)
  - message from central office, [6-15](#)
  - non-local Uniform Dial Plan (UDP), [6-11](#), [6-14](#)
  - non-local Uniform Dial Plan (UDP) routing, [6-15](#)
  - numbering conflicts, [5-28](#), [6-15](#)
  - PassageWay Telephony Services clients, [6-23](#)
  - preparation, [6-2](#)
  - Primary Rate Interface (PRI), [6-24](#)

Troubleshooting, (continued)

silence, [6-6](#), [6-26](#), [6-29](#), [6-30](#)

Station Message Detail Recording (SMDR), [6-25](#)

switch identifiers, [6-9](#), [6-19](#), [6-20](#), [6-29](#)

switch type, [6-9](#), [6-10](#), [6-28](#)

tandem PRI trunks, [6-9](#), [6-10](#), [6-28](#)

tandem tie trunks, [6-6](#), [6-26](#), [6-29](#), [6-30](#)

transfer, [6-15](#)

transfer not returning, [6-16](#)

warble tone, [6-11](#)

Trunk-to-trunk transfer

security, [4-3](#)

TTRs, see Touch-tone receivers (TTRs)

---

**U**

UDP routing, see Non-local Uniform Dial Plan (UDP) routing

Uniform Dial Plan (UDP)

illustration, [1-20](#)

introduction, [1-19](#)

---

**V**

Voice and/or data routing, [5-29](#)

Voice Announce to Busy

feature interactions, [3-27](#)

Voice mail, [3-27](#)

Voice mail/auto attendant

fails to transfer calls, [D-5](#)

touch-tone receivers (TTRs) required, [D-1](#)

Voice Messaging Interface (VMI)

feature interactions, [3-27](#)

---

**W**

Warble tone

troubleshooting, [6-11](#)

