

Lucent Technologies
Bell Labs Innovations



MERLIN LEGEND[®]
Communications System
Release 7.0
Feature Reference

555-670-110
Comcode 108370263
Issue 1
April 1999

Copyright © 1999, Lucent Technologies
All Rights Reserved
Printed in USA

Document 555-670-110
Comcode 108370263
Issue 1
April 1999

Notice

Every effort has been made to ensure that the information in this guide is complete and accurate at the time of printing. Information, however, is subject to change. See Appendix A, "Customer Support Information," in *System Programming* for important information.

Your Responsibility for Your System's Security

Toll fraud is the unauthorized use of your telecommunications system by an unauthorized party—for example, persons other than your company's employees, agents, subcontractors, or persons working on your company's behalf. Note that there may be a risk of toll fraud associated with your telecommunications system, and, if toll fraud occurs, it can result in substantial additional charges for your telecommunications services.

You and your system manager are responsible for the security of your system, such as programming and configuring your equipment to prevent unauthorized use. The system manager is also responsible for reading all installation, instruction, and system administration documents provided with this product in order to fully understand the features that can introduce risk of toll fraud and the steps that can be taken to reduce that risk. Lucent Technologies does not warrant that this product is immune from or will prevent unauthorized use of common-carrier telecommunication services or facilities accessed through or connected to it. Lucent Technologies will not be responsible for any charges that result from such unauthorized use. For important information regarding your system and toll fraud, see Appendix A, "Customer Support Information," in *System Programming*.

Federal Communications Commission Statement

This equipment has been tested and found to comply with the limits for a Class A digital device, pursuant to Part 15 of the FCC Rules. These limits are designed to provide reasonable protection against harmful interference when the equipment is operated in a commercial environment. This equipment generates, uses, and can radiate radio frequency energy and, if not installed and used in accordance with the instruction manual, may cause harmful interference to radio communications. Operation of this equipment in a residential area is likely to cause harmful interference, in which case the user will be required to correct the interference at their own expense. For further FCC information, see Appendix A, "Customer Support Information," in *System Programming*.

Canadian Department of Communications (DOC) Interference Information

This digital apparatus does not exceed the Class A limits for radio noise emissions set out in the radio interference regulations of the Canadian Department of Communications.

Le Présent Appareil Numérique n'émet pas de bruits radioélectriques dépassant les limites applicables aux appareils numériques de la classe A prescrites dans le règlement sur le brouillage radioélectrique édicté par le ministère des Communications du Canada.

Year 2000 Compliance

The MERLIN LEGEND Communications System is certified to be Year 2000 compliant. Additional information on this certification, and other issues regarding Year 2000 compliance, is available online at <http://www.lucent.com/entreprise/sig/yr2000>.

Trademarks

5ESS, AUDIX, CONVERSANT, CentreVu, DEFINITY, Magic On Hold, MERLIN, MERLIN LEGEND, MERLIN Mail, PARTNER, PassageWay, MLX-10, MLX-10D, MLX-10DP, MLX-16DP, MLX-20L, MLX-28D, MLS-6, MLS-12, MLS-12D, MLS-18D, MLS-34D, SYSTIMAX, TransTalk, and Voice Power are registered trademarks and 4ESS, Intuity, Lucent Technologies, and Prologix are trademarks of Lucent Technologies in the US and other countries.

Acculink, ACCUNET, MEGACOM, MultiQuest, MLX-5, MLX-5D, and NetPROTECT are registered trademarks of AT&T.

Microsoft, Windows, Windows NT, and MS-DOS are registered trademarks of Microsoft Corporation.

ProComm and ProComm Plus are registered trademarks of DataStorm Technologies, Inc.

Supra, Supra NC, StarSet, and Mirage are registered trademarks of Plantronics, Inc.

UNIX is a registered trademark of UNIX System Laboratories, Inc.

PagePac is a registered trademark and Powermate and Zonemate are trademarks of DRACON, a division of Harris Corporation.

Okidata is a registered trademark of Okidata Corporation.

Pipeline is a trademark of Ascend Communications, Inc.

Intel and Pentium are registered trademarks of Intel Corporation.

Apple and Macintosh are registered trademarks of Apple Computer, Inc.

IBM is a registered trademark of International Business Machines, Inc.

Novell and NetWare are registered trademarks of Novell Corporation.

CLASS is a servicemark of Bellcore.

Ordering Information

Call: BCS Publications Center
Voice 1-800-457-1235 International Voice 317-322-6791
Fax 1-800-457-1764 International Fax 317-322-6699

Write: BCS Publications Center
2855 North Franklin Road
Indianapolis, IN 46219-1385

Order: Document No. 555-670-110
Comcode: 108370263
Issue 1, April 1999

For more information about Lucent Technologies documents, refer to the section entitled "Related Documents" in "About This Guide" in *System Programming*.

Support Telephone Number

In the continental US, Lucent Technologies provides a toll-free customer helpline 24 hours a day. Call the Lucent Technologies Helpline at **1-800-628-2888** or your Lucent Technologies authorized dealer if you need assistance when installing, programming, or using your system. Outside the continental US, contact your local Lucent Technologies authorized representative.

Network Engineering Group

For assistance in designing a private network, call the Network Engineering Group at **1-888-297-4700**.

Lucent Technologies Corporate Security

Whether or not immediate support is required, all toll fraud incidents involving Lucent Technologies products or services *should be reported* to Lucent Technologies Corporate Security at **1-800-821-8235**. In addition to recording the incident, Lucent Technologies Corporate Security is available for consultation on security issues, investigation support, referral to law enforcement agencies, and educational programs.

Lucent Technologies Fraud Intervention

If you *suspect you are being victimized* by toll fraud and you need technical support or assistance, call BCS National Service Assistance Center at **1-800-628-2888**.

Warranty

Lucent Technologies provides a limited warranty on this product. Refer to "Limited Warranty and Limitation of Liability" in Appendix A, "Customer Support Information," of *System Programming*.

Contents

Contents	v
Figures	xi
Tables	xv
New Features and Enhancements	xix
Release 7.0 Enhancements (April 1999)	xix
Prior Releases: Features and Enhancements	xxiii
Release 6.1 Enhancements (August 1998)	xxiii
Release 6.0 Enhancements (February 1998)	xxvii
Release 5.0 Enhancements (June 1997)	xxxi
Release 4.2 Enhancements (June 1997)	xxxvi
Release 4.1 Enhancements (June 1997)	xxxix
Release 4.0 Enhancements (March 1996)	xli
Release 3.1 Enhancements (March 1996)	xliv
Release 3.0 Enhancements (August 1994)	xlvi
Release 2.1 Enhancements (August 1994)	l
Release 2.0 Enhancements (October 1992)	liii
Release 1.1 Enhancements (October 1992)	lvi
About This Guide	lix
Intended Audience	lix
How to Use This Guide	lix
Terms and Conventions Used	lxi
Security	lxiii
Related Documents	lxiv
How to Comment on This Guide	lxv

<u>Features</u>	<u>1</u>
■ <u>Overview</u>	<u>1</u>
■ <u>Index of Feature Names</u>	<u>2</u>
■ <u>Index of Features by Activity</u>	<u>14</u>
■ <u>Abbreviated Ring</u>	<u>29</u>
■ <u>Account Code Entry/Forced Account Code Entry</u>	<u>30</u>
■ <u>Alarm</u>	<u>37</u>
■ <u>Alarm Clock</u>	<u>40</u>
■ <u>Allowed/Disallowed Lists</u>	<u>42</u>
■ <u>Authorization Code</u>	<u>49</u>
■ <u>Auto Answer All</u>	<u>56</u>
■ <u>Auto Answer Intercom</u>	<u>59</u>
■ <u>Auto Dial</u>	<u>62</u>
■ <u>Automatic Line Selection and Ringing/Idle Line Preference</u>	<u>69</u>
■ <u>Automatic Maintenance Busy</u>	<u>75</u>
■ <u>Automatic Route Selection</u>	<u>77</u>
■ <u>Barge-In</u>	<u>95</u>
■ <u>Basic Rate Interface (BRI)</u>	<u>99</u>
■ <u>Call Waiting</u>	<u>110</u>
■ <u>Callback</u>	<u>116</u>
■ <u>Caller ID</u>	<u>125</u>
■ <u>Calling Restrictions</u>	<u>132</u>
■ <u>Camp-On</u>	<u>140</u>
■ <u>Centralized Voice Messaging</u>	<u>144</u>
■ <u>Centrex Operation</u>	<u>145</u>
■ <u>Conference</u>	<u>158</u>
■ <u>Coverage</u>	<u>170</u>
■ <u>CTI (Computer Telephony Integration) Link</u>	<u>208</u>
■ <u>Digital Data Calls</u>	<u>223</u>
■ <u>Direct-Line Console</u>	<u>231</u>
■ <u>Direct Station Selector</u>	<u>240</u>
■ <u>Direct Voice Mail</u>	<u>260</u>
■ <u>Directories</u>	<u>263</u>
■ <u>Display</u>	<u>271</u>
■ <u>Do Not Disturb</u>	<u>311</u>

■ Drop	316
■ Extension Status	317
■ Fax Extension	322
■ Forced Account Code Entry	325
■ Forward and Follow Me	326
■ Group Calling	350
■ Headset Options	388
■ Hold	395
■ HotLine	404
■ Idle Line Preference	408
■ Inside Dial Tone	409
■ Inspect	410
■ Labeling	413
■ Language Choice	418
■ Last Number Dial	423
■ Line Request	427
■ Messaging	429
■ Microphone Disable	444
■ Multi-Function Module	446
■ Music-On-Hold	454
■ Night Service	458
■ Notify	469
■ Paging	470
■ Park	479
■ Personal Lines	484
■ Personalized Ringing	493
■ Pickup	494
■ Pools	500
■ Power-Failure Transfer	507
■ Primary Rate Interface (PRI) and T1	509
■ Privacy	553
■ Programming	557
■ Queued Call Console (QCC)	565
■ Recall/Timed Flash	590
■ Reminder Service	598

■ Remote Access	602
■ Ringing Line Preference	617
■ Ringing Options	618
■ Saved Number Dial	626
■ Second Dial Tone Timer	630
■ Service Observing	632
■ Signal/Notify	645
■ Speed Dial	648
■ Station Message Detail Recording (SMDR)	655
■ System Access/Intercom Buttons	673
■ System Renumbering	685
■ Timed Flash	698
■ Tandem Switching	699
■ Timer	712
■ Toll Type	714
■ Touch-Tone or Rotary Signaling	716
■ Transfer	723
■ Uniform Dial Plan Features	741
■ Voice Announce	757
A Customer Support Information	A-1
■ Support Telephone Number	A-1
■ Federal Communications Commission (FCC) Electromagnetic Interference Information	A-1
■ Canadian Department of Communications (DOC) Interference Information	A-2
■ FCC Notification and Repair Information	A-2
■ Installation and Operational Procedures	A-4
■ DOC Notification and Repair Information	A-5
■ Renseignements sur la Notification du Ministère des Communications du Canada et la Réparation	A-6
■ Security of Your System: Preventing Toll Fraud	A-8
■ Toll Fraud Prevention	A-10
■ Other Security Hints	A-16
■ Limited Warranty and Limitation of Liability	A-20
■ Remote Administration and Maintenance	A-21

<u>B</u>	<u>Features and Planning Forms</u>	<u>B-1</u>
<u>C</u>	<u>System Features</u>	<u>C-1</u>
<u>D</u>	<u>General Feature Use and Telephone Programming</u>	<u>D-1</u>
	■ <u>General Feature Use Information</u>	<u>D-1</u>
	■ <u>Telephone and Operator Features</u>	<u>D-3</u>
	■ <u>Telephone Programming</u>	<u>D-28</u>
<u>E</u>	<u>System Programming Menu Hierarchy</u>	<u>E-1</u>
<u>F</u>	<u>Sample Reports</u>	<u>F-1</u>
	■ <u>System Information Report</u>	<u>F-7</u>
	■ <u>Dial Plan Report</u>	<u>F-9</u>
	■ <u>Non-Local Dial Plan Report</u>	<u>F-12</u>
	■ <u>Label Information Report</u>	<u>F-13</u>
	■ <u>Tie Trunk Information Report</u>	<u>F-14</u>
	■ <u>DID Trunk Information Report</u>	<u>F-15</u>
	■ <u>GS/LS Trunk Information Report</u>	<u>F-16</u>
	■ <u>General Trunk Information Report</u>	<u>F-17</u>
	■ <u>DS1 Information Report</u>	<u>F-18</u>
	■ <u>PRI Information Report</u>	<u>F-19</u>
	■ <u>Remote Access (DISA) Information Report</u>	<u>F-23</u>
	■ <u>Operator Information Report</u>	<u>F-24</u>
	■ <u>Allowed Lists Report</u>	<u>F-26</u>
	■ <u>Access to Allowed Lists Report</u>	<u>F-27</u>
	■ <u>Disallowed Lists Report</u>	<u>F-28</u>
	■ <u>Access to Disallowed Lists Report</u>	<u>F-29</u>
	■ <u>Automatic Route Selection Report</u>	<u>F-30</u>
	■ <u>Extension Directory Report</u>	<u>F-31</u>
	■ <u>System Directory Report</u>	<u>F-32</u>
	■ <u>Group Paging Report</u>	<u>F-33</u>
	■ <u>Extension Information Report</u>	<u>F-34</u>
	■ <u>Group Coverage Information Report</u>	<u>F-36</u>
	■ <u>Direct Group Calling Information Report</u>	<u>F-37</u>
	■ <u>Night Service Information Report</u>	<u>F-39</u>
	■ <u>Group Call Pickup Report</u>	<u>F-40</u>
	■ <u>Error Log Report</u>	<u>F-41</u>

■	Authorization Code Information Report	F-42
■	BRI Information Report	F-43
■	Switch 56 Data Information Report	F-44
<u>G</u>	<u>Button Diagrams</u>	<u>G-1</u>
<u>H</u>	<u>Programming Special Characters</u>	<u>H-1</u>
■	Single-Line Telephones	H-1
■	Analog Multiline Telephones	H-2
■	MLX-10 and MLX-5 Non-display Telephones	H-3
■	MLX Display Telephones	H-4
■	ETR and MLS Non-display Telephones	H-5
■	ETR and MLS Display Telephones	H-6
<u>I</u>	<u>Applications</u>	<u>I-1</u>
■	Organization of Descriptions	I-2
■	System Support for Applications	I-3
■	Supported Printers	I-4
■	PassageWay Direct Connection Solution	I-5
■	Voice Messaging Systems	I-6
■	MERLIN LEGEND Mail	I-10
■	Messaging 2000	I-15
■	MERLIN LEGEND Enhanced Service Center	I-16
■	Call Accounting System	I-17
■	Call Accounting Terminal	I-20
■	MERLIN LEGEND Reporter	I-23
■	System Programming and Maintenance	I-29
■	Intuity	I-31
■	Intuity CONVERSANT	I-32
■	TransTalk 9000 Digital Wireless System	I-33
■	Business Cordless 905 Telephone	I-34
■	Videoconferencing	I-34
■	ISDN Terminal Adapter	I-41
<u>GL</u>	<u>Glossary</u>	<u>GL-1</u>
<u>IN</u>	<u>Index</u>	<u>IN-1</u>

Figures

Features

1	ARS Table Selection	86
2	ARS Route Selection within a Table	87
3	Subpattern Selection	88
4	Full Centrex Service	147
5	Limited Centrex Service	148
6	Group Coverage Only or All Individual Coverage Receivers Unavailable (Release 4.1 and Later Systems Only)	186
7	Group Coverage Only or All Individual Coverage Receivers Unavailable (Release 4.0 and Prior Systems)	187
8	Individual (Primary and Secondary) and Group Coverage Ringing Patterns (Release 4.1 and Later Systems Only)	188
9	Individual (Primary and Secondary) and Group Coverage Ringing Patterns (Release 4.0 and Prior Systems)	189
10	Cover to Voice Mail with Escape to System Operator	190
11	Primary Coverage	191
12	Phantom Calling Groups	193
13	Phantom Extensions	194
14	Coverage and Direct Voice Mail	195
15	Direct Station Selector (DSS)	242
16	2-Line Display Home Screen	277
17	7-Line Display Home Screen	277
18	2-Line Display Menu Screen	278
19	7-Line Display Menu Screen	278
20	2-Line Display Inspect Screen for Programmed Button	281
21	7-Line Display Inspect Screen for Programmed Button	281
22	Home Calling Group with a Support Calling Group	361
23	Two Calling Groups Supporting Each Other	362

Figures

xii

24	Multiple Home Groups Sharing a Support Group	363
25	A Support Calling Group with its Own Support Calling Group	364
26	PRI Lines and B-Channel Groups	517
27	PRI Call Processing (Non-Tandem Only)	533
28	MLX-20L Telephone and DSS	560
29	System Programming Console Overlay	560
30	SPM Display	562
31	QCC Button Assignments	571
32	Sample SMDR Report in ISDN Format	658
33	2-Digit Numbering Plan	688
34	3-Digit Numbering Plan	690
35	Set Up Space Numbering Plan	692

G Button Diagrams

G-1	MLX-20L and MLX-28D Telephone (Hybrid/PBX Mode)	G-1
G-2	MLX-16DP Telephone (Hybrid/PBX Mode)	G-2
G-3	MLX 5- and 10-Button Telephone (Hybrid/PBX Mode)	G-2
G-4	Analog Multiline Telephone (Hybrid/PBX Mode)	G-3
G-5	MLX-20L and MLX-28D Telephone (Key and Behind Switch Modes)	G-4
G-6	MLX-16DP Telephone (Key and Behind Switch Modes)	G-4
G-7	MLX 5- and 10-Button Telephone (Key and Behind Switch Modes)	G-5
G-8	Analog Multiline Telephone (Key and Behind Switch Modes)	G-5
G-9	ETR-34D Telephone (Hybrid/PBX Mode)	G-6
G-10	ETR-18/18D Telephone (Hybrid/PBX Mode)	G-6
G-11	ETR-6 Telephone (Hybrid/PBX Mode)	G-7
G-12	MLS-34D Telephone (Hybrid/PBX Mode)	G-7
G-13	MLS-18D Telephone (Hybrid/PBX Mode)	G-8
G-14	MLS-12/12D, TransTalk, or Business Cordless 905 Telephone (Hybrid/PBX Mode)	G-8

Figures

xiii

G-15	MLS-6 Telephone (Hybrid/PBX Mode)	G-8
G-16	ETR-34D Telephone (Key Mode)	G-9
G-17	ETR-18/18D Telephone (Key Mode)	G-9
G-18	ETR-6 Telephone (Key Mode)	G-10
G-19	MLS-34D Telephone (Key Mode)	G-10
G-20	MLS-18D Telephone (Key Mode)	G-11
G-21	MLS-12/12D, TransTalk, or Business Cordless 905 Telephone (Key Mode)	G-11
G-22	MLS-6 Telephone (Key Mode)	G-11
G-23	ETR-34D Telephone (Behind Switch Mode)	G-12
G-24	ETR-18/18D Telephone (Behind Switch Mode)	G-12
G-25	ETR-6 Telephone (Behind Switch Mode)	G-13
G-26	MLS-34D Telephone (Behind Switch Mode)	G-13
G-27	MLS-18D Telephone (Behind Switch Mode)	G-14
G-28	MLS-12/12D, TransTalk, or Business Cordless 905 Telephone (Behind Switch Mode)	G-14
G-29	MLS-6 Telephone (Behind Switch Mode)	G-14

I Applications

I-1	Call Accounting Terminal Basic	I-21
I-2	Call Accounting Terminal Plus	I-22

Tables

Features

1	Special Characters for Outside Auto Dial	63
2	Factory-Set Automatic Line Selection Sequence	71
3	Facility Restriction Levels	88
4	Ring Delays Affecting Coverage	174
5	Ring Timing Options	176
6	Ringling on Individual Coverage (Receiver) Buttons	176
7	Calls Eligible and Calls Ineligible for Coverage	180
8	Group Coverage Call delivery Rules (Release 4.1 and Later Systems)	184
9	Group Coverage Call Delivery Rules (Release 4.0 and Prior Systems)	185
10	Results of Pressing DSS Button while Active on a Call: DLC Position with One-Touch Hold	244
11	Results of Pressing DSS Button while Active on a Call: DLC Position with One-Touch Transfer	245
12	Results of Pressing DSS Button while Active on a Call: QCC Position	246
13	ED Meanings for Normal Call-Handling Operation	247
14	LED Meanings for Supervisor Operation without Message Status Active	249
15	LED Meanings for Hotel Extension Status Operation without Message Status Active	250
16	LED Meanings for Hotel Extension Status Operation with Message Status Active	251
17	LED Meanings for Supervisor or Hotel Extension Status Operation with Message Status Active	251
18	Call-Handling Displays	273
19	Feature Screen Option	279

Tables

xvi

20	Extension Status for Hotel Mode	318
21	Extension Status for Calling Group/CMS Mode	319
22	Forwarded Call Ringing	334
23	Eligibility of Calling Group Calls for Queue Control	358
24	Checking the Effectiveness of Delay Announcements	374
25	Factory-Set Posted Messages and Their Codes	415
26	Receiving Messages Functions	434
27	Message-Waiting Display Identifiers	435
28	Posted Messages	437
29	Call Types and Transfer Audible	455
30	Types of Pickup – Individual	495
31	Line Compensation Settings	526
32	Sample PRI Dial-Plan Routing Table	535
33	Sample Network Selection Table	539
34	Sample Special Services Selection Table	539
35	Sample Call-by-Call Services Table	540
36	Sample T1 Switched 56 Dial-Plan Routing Table	545
37	Features Available at Call Progress Stages	570
38	QCC Buttons	571
39	Remote Access Routing	608
40	Distinctive Ringing	621
41	Error Tones	633
42	Renumbering Extensions	693
43	System Requirements for TTRs	719
44	TTRs Required by Voice Messaging Systems/Auto Attendants	719
45	TTRs Required for Primary Delay Announcement Devices When Using Prompt-Based Overflow	720
46	TTRs Required for Secondary Delay Announcement Devices When Using Prompt-Based Overflow	720
47	Modules with TTRs	721

IMPORTANT SAFETY INSTRUCTIONS



The exclamation point in an equilateral triangle is intended to alert the user to the presence of important operating and maintenance (servicing) instructions in the literature accompanying the product.

To reduce the risk of fire, electrical shock, and injury to persons, follow these basic safety precautions when installing telephone equipment:

- Read and understand all instructions.
- Follow all warnings and instructions marked on or packed with the product.
- Never install telephone wiring during a lightning storm.
- Never install a telephone jack in a wet location unless the jack is specifically designed for wet locations.
- Never touch uninsulated telephone wires or terminals unless the telephone wiring has been disconnected at the network interface.
- Use caution when installing or modifying telephone lines.
- Use only Lucent Technologies-manufactured MERLIN LEGEND Communications System circuit modules, carrier assemblies, and power units in the MERLIN LEGEND Communications System control unit.
- Use only Lucent Technologies-recommended/approved MERLIN LEGEND Communications System accessories.
- If equipment connected to the analog extension modules [008 (ATL), 408 (LS-ATL), and 408 GS/LS], the MLX telephone modules (008 MLX, 408 GS/LS-MLX, 408 GS/LS-ID-MLX, and 016 MLX), or the ETR telephone modules (412 LS-ID-ETR and 016 ETR) is to be used for in-range out-of-building (IROB) applications, IROB protectors are required.
- Do not install this product near water—for example, in a wet basement location.
- Do not overload wall outlets, as this can result in the risk of fire or electrical shock.
- The MERLIN LEGEND Communications System is equipped with a 3-wire grounding-type plug with a third (grounding) pin. This plug will fit only into a grounding-type power outlet. This is a safety feature. If you are unable to insert the plug into the outlet, contact an electrician to replace the obsolete outlet. Do not defeat the safety purpose of the grounding plug.
- The MERLIN LEGEND Communications System requires a supplementary ground.

- Do not attach the power supply cord to building surfaces. Do not allow anything to rest on the power cord. Do not locate this product where the cord will be abused by persons walking on it.
- Slots and openings in the module housings are provided for ventilation. To protect this equipment from overheating, do not block these openings.
- Never push objects of any kind into this product through module openings or expansion slots, as they may touch dangerous voltage points or short out parts, which could result in a risk of fire or electrical shock. Never spill liquid of any kind on this product.
- Unplug the product from the wall outlet before cleaning. Use a damp cloth for cleaning. Do not use cleaners or aerosol cleaners.
- Auxiliary equipment includes answering machines, alerts, modems, and fax machines. To connect one of these devices, you must first have a Multi-Function Module (MFM).
- Do not operate telephones if chemical gas leakage is suspected in the area. Use telephones located in some other safe area to report the trouble.



WARNING:

- For your personal safety, **DO NOT** install an MFM yourself.
- **ONLY** an authorized technician or dealer representative shall install, set options, or repair an MFM.
- To eliminate the risk of personal injury due to electrical shock, **DO NOT** attempt to install or remove an MFM from your MLX telephone. Opening or removing the module cover of your telephone may expose you to dangerous voltages.

SAVE THESE INSTRUCTIONS

New Features and Enhancements

Release 7.0 Enhancements (April 1999)

Release 7.0 includes all Release 6.1 functionality, plus the enhancements listed below. For a description of features and enhancements in prior releases, see “Prior Releases: Features and Enhancements” in *System Programming*.

MLS and Enhanced Tip/Ring (ETR) Telephone Support

One of the most important new capabilities of MERLIN LEGEND Release 7.0 is its support for MLS and ETR telephones, allowing existing customers with either telephones the ability to migrate to a MERLIN LEGEND Communications System. The MLS telephones include the MLS-6[®], MLS-12[®], MLS-12D[®], MLS-18D[®], and MLS-34D[®]. The ETR telephones include the ETR-6, ETR-18, ETR-18D, and ETR-34D. The Business Cordless 905 telephone and the TransTalk™ 9000 Digital Wireless System are also supported.

The MLS, ETR, and Business Cordless 905 telephones, as well as the TransTalk 9000 Digital Wireless System, require ETR station ports. To provide support for these telephones and for the TransTalk 9000 system, two new modules have been designed:

- **412 LS-ID-ETR Module.** The 412 LS-ID-ETR module provides 4 LS trunks with Caller ID and 2 touch tone receivers (TTRs) plus 12 ETR station ports, including 4 with Tip/Ring (T/R) functionality. On the 412 LS-ID-ETR module, the first 8 ports are ETR ports only—these ports do not have T/R functionality. The remaining 4 ports (ports 9 through 12) can be

programmed to support either T/R or ETR, but not both simultaneously. This module does not have a separate PFT port. In the event of a power failure, port 12 becomes the PFT port for line 1. If the port is programmed for ETR operation, a single-line telephone must be plugged into the port for operation during power failure.

If caller identification is subscribed to from the local telephone company, the 412 LS-ID-ETR module displays the telephone number of incoming callers (from supported areas) on ETR and MLS display telephones. In addition, a button on the ETR and MLS telephone can be programmed to toggle between displaying caller name or caller number.

- **016 ETR Module.** The 016 ETR module provides 16 ETR station ports, including 6 with T/R functionality and 4 TTRs. On the 016 ETR module, the first 10 ports are ETR ports only—these ports do not have T/R functionality. The remaining 6 ports (ports 11 through 16) can be programmed to support either T/R or ETR, but not both simultaneously.

Expanded Digital Endpoint Connectivity

Release 7.0 increases the maximum number of digital telephones supported from 127 to 200 by introducing a new 016 MLX module. In addition, each of the 200 ports can support an MFM adjunct which increases the current 255 station endpoints to 400.

- **016 MLX Module.** Each 016 MLX module provides 16 digital station ports and has an additional 32K of dual port RAM.
- **Processor Module.** The 016 MLX module can only be utilized with the CKE4 or later processor module with upgrade to R7.0 software. The CKE4 processor module provides the lead to access the additional 32K of RAM on the 016 MLX module.

Voice Announce on Idle Only Option on MLX Telephones

Prior to Release 7.0, no options were available for disabling intercom voice announcements at an MLX telephone when busy. In Release 7.0, a new option—Voice Announce on IDLE ONLY—is available with the existing Voice Announce feature. This new option allows a user to receive intercom voice announcements only when they are not active on another call.

Priority Call Queuing

Priority call queuing provides the ability to:

- Place some callers ahead of others who are waiting for the same agent group.
- Give key clients priority over others.
- Automatically increase the number of agents answering calls during busy times, while continuing to offer callers the choice to leave a message instead of waiting.
- Keep costs down by handling toll free calls (calls arriving on 800 and 888 lines) before processing calls on local lines.

Priority call queuing is accomplished in Release 7.0 by allowing you to define a supportive relationship between calling groups. Calls that arrive in one calling group can be processed by another calling group when no one from the first calling group is available to answer the call. Through system programming, a calling group can be assigned a priority level between 1 (highest priority) and 32 (lowest priority) and then designated as a support group for another group.

Calling Party Name on Caller ID

Release 7.0 continues to support Calling Party Number and adds a new functionality for Calling Party Name. By programming a button on the telephone or with a feature code through centralized programming, users are able to toggle between displaying the caller's telephone number or the caller's name. In order to use this feature, users must subscribe to caller identification from their local exchange carrier (LEC).

Calling Party Name can be 15 characters in length for MLX telephones as well as for ETR and MLS telephones. Calling Party Name is not recorded on SMDR reports. In addition, neither Calling Party Name nor Calling Party Number are displayed on analog multiline telephones.

This feature requires loop-start (LS) trunks. The existing LS-ID delay feature must be programmed for each line, as well. This prevents Calling Party Number and Name information from being lost when a call is answered too quickly.

Release 7.0 software also supports the Caller ID capability of the 408 GS/LS-ID-MLX module. Although previously orderable, the Caller ID capability of this module could not be used until Release 7.0 software became available.

MLX Headset Operation

Headset operation in Release 7.0 has been enhanced so that MLX headset operation more closely mimics the handset operation in the following ways:

- When a person is on a call using a headset and the headset auto-answer is turned on, the user hears a short ring when another call is coming in. In previous releases, this ring was not provided.
- When a person receives a voice-announced call and handles the call by using a headset and turning off the speakerphone, the associated LEDs (the DSS button and the inside Auto Dial button) for that extension at other telephones are lit. In previous releases, the LEDs for that extension did not light at the other telephones.
- When a reliable disconnect occurs on a headset-handled call, the associated LEDs (the DSS button and the inside Auto Dial button) for that extension at other telephones are turned off. In previous releases, the LEDs for that extension remained lit at the other telephones unless the user pressed the Headset Hangup button.

Touch-Tone or Rotary Signaling

Beginning in Release 7.0, you can program tip/ring ports to use rotary signaling. You can program any tip/ring port on an individual basis (including ports on the 412 LS-ID-ETR and 016 ETR modules that are programmed for tip/ring operation). The factory setting is that rotary signaling is disabled.

Whenever the system receives a rotary digit on a port, it determines if the port is programmed as rotary-enabled. If the port is rotary-enabled, the system processes the digit. If the port is not rotary-enabled, the digit is rejected. Touch-tone digits are always accepted by the port, regardless if it is rotary-enabled or not.

Abandoned Call Information Reported to MERLIN LEGEND Reporter

For abandoned calls, you are now able to identify the queue or the agent where the call was abandoned. The MERLIN LEGEND Release 7.0 software has been modified so that either of the following occurs:

- If the caller hangs up while the call is in queue, the Auto Login/Logout Group ID is entered into the Station Message Detail Recording (SMDR) record.
- If the caller hangs up while the call is ringing at a group member's extension, that group member's extension number is entered into the SMDR record.

Prior Releases: Features and Enhancements

Release 6.1 Enhancements (August 1998)

Release 6.1 includes all Release 6.0 functionality plus the enhancements listed below.

Private Networking

Release 6.1 enhances the functioning of the networked MERLIN LEGEND Communications System in a number of ways:

- Centralized Voice Messaging
- Group Calling Enhancements
- Transfer Redirect
- Direct Station Selector
- Call Forwarding
- SMDR
- Decrease in Call Set-Up Time
- PRI Switch Type Test

Centralized Voice Messaging

One or more MERLIN LEGEND Systems (Release 6.1 or later) can share the voice messaging system (VMS) of another MERLIN LEGEND System, provided the systems are directly connected to the system with the VMS. In this configuration, the system containing the VMS is known as the *hub*. This sharing of the VMS is called *Centralized Voice Messaging*. Centralized Voice Messaging includes the functions of voice mail, Automated Attendant, and fax messaging. See the *Network Reference* for detailed information about Centralized Voice Messaging.

Centralized Voice Messaging offers the following benefits:

- Private-networked MERLIN LEGEND Systems do not need a local VMS. Having systems use a centralized VMS instead of separate VMSs is more economical.
- Users who travel between sites can dial the same digits anywhere in the private network to access the voice messaging system. For example, a salesperson headquartered in Cincinnati can dial the same four digits at the company's Los Angeles office to retrieve voice messages.
- Productivity is enhanced because messages can be forwarded and broadcast to all personnel within the private network.
- Calling groups on networked systems can send overflow coverage to a shared VMS, so that an incoming caller can leave a message instead of waiting in a queue.
- The VMS can light the Message Waiting lights on multiple MERLIN LEGEND Systems in a private network. This greater efficiency saves time because a user only has to look at his or her telephone to determine if he or she has a message.

Group Calling Enhancements

A calling group can have a *single* non-local member that is defined by the Uniform Dial Plan and exists on another MERLIN LEGEND Communications System connected by a tandem trunk to the local system. If a calling group contains a non-local member, the non-local member must be the *only* member in the calling group. See the *Network Reference* for details.

A calling group containing a single non-local member can be used for the same purposes as a calling group containing local extensions, including:

- **Night Service.** Night Service coverage can be provided across a private network to a centralized Automated Attendant, a non-local calling group, a QCC queue, a DLC, or any individual extension on the remote system, such as a night bell.

- **Group Coverage.** Group Coverage can be provided across a private network to a VMS, a non-local calling group, a QCC queue, a DLC, or any individual extension on the remote system.
- **Calling Group Overflow Coverage.** Calling group overflow coverage can be provided by a centralized VMS, a non-local calling group, a QCC queue, a DLC, or any individual extension on the remote system.
- **Calls Directed to Another System.** Lines connected to remote systems can be answered by any extension programmed to answer the call, such as a centralized Automated Attendant or a system operator (QCC or DLC).

Transfer Redirect

When an Automated Attendant transfers a call to a non-local extension, the transferring MERLIN LEGEND System monitors the call to ensure that it is answered. If the non-local extension is not available, or the call is not answered within the transfer redirect timeout period (fixed at 32 seconds), the call stops ringing at the non-local destination and is redirected to the extension on the same system as the Automated Attendant that is programmed to receive redirected calls. This redirect extension can be a QCC queue, a calling group, or an individual extension.

Direct Station Selector

Now users can press a Direct Station Selector (DSS) button for a non-local extension to make or transfer calls to that extension. No busy indication, however, is displayed by the DSS for non-local extensions.

Call Forwarding

The Forward feature now can be used to send calls to non-local extensions across the private network.

SMDR

In addition to SMDR options for non-network calls placed to and from the local system, system managers now can program SMDR to log incoming and outgoing UDP calls, or they can choose to log no UDP calls. The factory setting is to record all UDP calls.

Customers who use a call accounting system may not want to fill the database with calls coming and going across the private network. These customers may choose not to log UDP calls.

Decrease in Call Setup Time

The setup time for a call across a private network has been reduced by programming the number of UDP digits expected.

PRI Switch Type Test

A new maintenance test, the PRI Switch Type Test, has been created to allow Lucent Technologies technicians or authorized dealers to automatically determine if each end of the PRI tandem trunks has been programmed correctly. The test works for directly connected MERLIN LEGEND Systems, not for DEFINITY® systems.

For a PRI tandem trunk to operate correctly between two MERLIN LEGEND Systems, one system must have the PRI Switch Type set to Network, and the other system must have the PRI Switch Type set to PBX. If both ends of the PRI tandem trunk are programmed the same, problems occur in the communications between the two systems.

Service Observing

Service Observing allows one extension to listen in on (observe) a call at another extension. A typical application of this feature is that of a Customer Service supervisor observing how a Customer Service representative handles calls.

The Service Observing group can listen to anywhere from one extension to all extensions in the system, including other Service Observers. Up to 16 Service Observing groups can be programmed. The Service Observer and the observed extension must be on the same system.

The observer activates Service Observing either by pressing a Service Observing button and then dialing an extension number, or by pressing a DSS or Auto Intercom button. The Service Observer must use an MLX telephone to observe an extension; the telephone at the observed extension can be of any type.

A warning tone that alerts the observer, the observed extension, and the caller that Service Observing is occurring can be set to on or off through System Programming. The factory setting is on.

WinSPM

The System Programming and Maintenance (SPM) software is now available in a Windows format called WinSPM. For R6.1 and later systems, WinSPM provides a graphical user interface (GUI) for those tasks most commonly performed by the system manager. Pictorial representations of system components, such as modules and their vintages and the creation of MLX telephone button labels

appear on WinSPM. Supported in Windows 95, Windows NT, and Windows 98, WinSPM is also backwards-compatible with previous DOS versions of SPM and is available on CD-ROM.

Windows NT Driver

The MERLIN LEGEND Windows NT PBX driver is available in R6.1. When coupled with the CentreVU Telephony Services application, the driver provides true server-based Computer Telephony Integration (CTI). The new driver requires a MERLIN LEGEND System of Release 5.0 or later and servers and PCs that support the applications.

Release 6.0 Enhancements (February 1998)

Release 6.0 includes all Release 5.0 functionality, plus the enhancements listed below.

Private Networks

In Hybrid/PBX mode systems only, MERLIN LEGEND Communications Systems can be networked with one another or with DEFINITY Enterprise Communications Server (ECS) and ProLogix™ Communications Systems in private networks. In previous releases, this functionality is available using tie lines, but users handle calls between networked switches as outside calls. In this release, dialing the pool access code is not necessary for a call going from one networked switch to another. Also, delay-start tie trunks or T1 trunks administered as PRI can act as *tandem trunks* to connect networked systems.

Available for Hybrid/PBX mode systems, the private network features of the MERLIN LEGEND Communications System Release 6.0 provide the following advantages for geographically dispersed organizational sites:

- **Intersystem Calling.** In a private network, users on one local system can call extensions on other systems in the network. Release 6.0 can support 2-, 3-, 4-, or 5-digit dial plans. They dial these extensions as inside calls. To implement this function, the system manager programs the extension ranges of remote networked switches to create a non-local dial plan. This programming does not actually affect numbering on the remote system. To correctly set up systems for transparent calling among non-local dial plan extensions, the system manager assigns networking tie and/or PRI tandem trunks to pools. Then he or she programs up to 20 patterns, associated routes, Facility Restriction Levels (FRLs), digit absorption, and digit prepending. This allows ARS-like routing of non-local dial plan calls. In

addition, system managers can control whether calling name, calling number, or both are shown at MLX display telephones for incoming calls across PRI tandem trunks.

- **Toll Savings.** Private networked trunks may allow you to realize significant cost savings on long-distance and toll calls by performing tandem switching in the following two ways:
 - Callers on a local system, or individuals dialing in to remote access at a local system, can reach the public switched telephone network (PSTN) via outside trunks connected to other systems in a private network, avoiding toll charges or decreasing the cost of toll calls. No special dialing is required. For example, an organization might have a main office in Boston and a subsidiary office in New Jersey connected by networked private tandem trunks between two systems. A user in the New Jersey office who wishes to make an outside call to the 617 area code (Boston) can do so through a line/trunk connected to the system in Boston. For example, he or she might dial, 916175551211. The local ARS tables would route this call over the private networked trunks and use the ARS tables of the remote system in Boston to route this call. The system managers at each end of a private network set up ARS and Remote Access features to implement this functionality.
 - In addition, local organizations or incoming DID calls use private networked trunks to make intersystem calls between networked systems, which may be geographically distant from one another, also resulting in toll savings.
- **Service Cost Savings.** In addition to toll call savings, there are two ways that organizations can save on service costs incurred from telecommunications providers that provide public switched telephone network access:
 - You order a point to point T1 facility from a service provider, then use system programming to set it up for PRI signalling. As necessary, a service provider can provide amplification on the T1 facility, but does not supply switching services.
 - You can tailor your use of PRI B-channels with drop-and-insert equipment that allows fractional use of B-channels for dedicated data/video communications between systems at speeds greater than 64 kbps per channel or 128 kbps for 2B data, while keeping the remaining B-channels available for PRI voice traffic. The PRI D-channel must remain active.
 - You can tailor use of T1 channels to support both T1-emulated tandem tie service and T1 Switched 56 service for data communications at 56 kbps per channel, allowing 2B data transfers at 112 kbps. You can also use drop-and-insert equipment to provide fractional T1 use.

- **Voice Mail and Auto Attendant.** Networked systems (prior to Release 6.1) should have their own local voice mail and/or auto attendant applications as well as their own external alerts and Music-On-Hold sources. A single Auto Attendant, however, can transfer calls throughout the network. It can answer only those calls that arrive on the PSTN facilities of the system where it is connected.

Although many features are available using tie trunks for network connectivity, PRI tandem trunks provide greatly enhanced features and faster call setup. For this reason, PRI is recommended over tie functionality in private networks.

Group Calling Enhancements

Release 6.0 and later systems include Group Calling features that enhance group calling operations.

Queue Control

The system manager can control the maximum number of calls allowed in the primary calling group queue for calls that arrive on certain facilities often assigned to calling groups. When the number of the calls in queue reaches the programmed maximum, subsequent callers receive a busy signal.

Queue control applies to calls received on the following types of facilities:

- Direct Inward Dialing (DID)
- PRI facilities programmed for dial-plan routing
- All calls transferred from a voice messaging interface (VMI) port
- Dial-in Tie

Queue control also applies to internal calls to a calling group and calls to a calling group through the Queued Call Console (QCC).

Internal calls that dial #0 or #800 and are directed to a calling group administered as Position-Busy Backup are eligible for queue control. Calls that come in on a trunk assigned to the QCC are not eligible for queue control if the call is directed to a calling group designated as Position-Busy Backup.

Remote-access calls to a calling group, coverage calls directed to a calling group, calls directed to a calling group through QCC Position-Busy Backup, and all other outside calls are not eligible for queue control.

Prompt-Based Overflow

System managers can activate the Prompt-Based Overflow option. This option allows callers waiting in queue and listening to a delay announcement to press the # key in order to reach the overflow receiver for the group, which may be the QCC queue or another calling group (including a calling group assigned for a voice mail system).

All three overflow distribution options—based on the number of calls, the time a caller has waited, and according to the caller's prompt—may be used at one time. In this case, time-based and number-of-calls based options take precedence over overflow distribution based on the caller's prompt.

When prompt-based overflow distribution is used, an extra TTR must be provided for each delay announcement device assigned to the associated calling group. The delay announcement informs the caller of the # key option to exit the queue and leave rather than waiting for an agent. If no TTR is available when a calling group call arrives, the call is not sent to a delay announcement extension.

Centrex Transfer via Remote Call Forwarding

Centrex Transfer via Remote Call Forwarding can be used in all system modes of operation to send outside calls to a remote telephone number or another Centrex station. In this context, the term *outside calls* refers to calls from outside the communications system, which may originate at extensions in the Centrex system that are not connected to the local MERLIN LEGEND Communications System.

An outside call that uses this feature is defined as a call that arrives on an analog Centrex loop-start line at the MERLIN LEGEND Communications System. It may arrive directly or be transferred without consultation or without transfer supervision (in the case of an automated attendant). The forwarding call to the outside number is made on the same line/trunk on which the call arrived, conserving system facilities. The following considerations and rules apply:

- Only outside Centrex calls are forwarded using this feature.
- The system must be equipped with analog loop-start Centrex lines and *all* loop-start lines in the system must be Centrex facilities. Loop-start lines do not have to provide reliable disconnect for use by the Centrex Transfer via the Remote Call Forwarding feature.
- To transfer calls outside the Centrex system, the organization must subscribe to a Centrex trunk-to-trunk transfer feature.

Activating Centrex Transfer via Remote Call Forwarding is just like activating regular Remote Call Forwarding and requires that Remote Call Forwarding be enabled for the extension. However, the user dials * instead of a dial-out code, and a Pause character may be required after the *. The Centrex service provider determines whether the Pause is needed.

Pause cannot be originated from a single-line telephone or a remote access user. A multiline telephone user in the local system must enter an authorization code to activate the feature.

A remote access user may activate the feature without using an authorization code. Barrier code requirements, however, do apply.

Authorization Codes and Remote Call Forwarding

In Release 6.0 and later Key or Hybrid/PBX mode systems, forwarding features (including Centrex Transfer via Remote Call Forwarding, but excluding Follow Me) can be activated or deactivated at a multiline telephone by entering the authorization code for the extension from which calls are to be forwarded. The user enters the authorization code, then activates or deactivates the forwarding feature in the normal fashion. This is especially useful for a single-line telephone user who must include a Pause character in a Centrex Transfer via Remote Call Forwarding dialing sequence, because the character cannot be dialed at a single-line telephone. It is also useful when activating Call Forwarding or Remote Call Forwarding at phantom stations or via remote access (for example, from another switch in the network). No other features can be used by entering an authorization code in this fashion.

Release 5.0 Enhancements (June 1997)

Release 5.0 includes all Release 4.2 functionality, plus the enhancements listed below.

Computer Telephony Integration (CTI)

Beginning with Release 5.0, a PassageWay[®] Telephony Services CTI link from the MERLIN LEGEND Communications System to a LAN server running Novell[®] NetWare[®] software allows Lucent Technologies-certified telephony applications to control and monitor MLX and analog multiline telephone (BIS only) operations. The physical connection for the CTI link is an MLX port on a 008 MLX or 408 MLX module on the MERLIN LEGEND Communications System control unit and an ISDN link interface card plugged into the customer's server. The feature is available for Hybrid/PBX mode systems only.



NOTES:

- The NetWare server software version must be 3.12, 4.1, or 4.11.

- The 008 MLX and 408 MLX modules must have a firmware vintage other than 29. If the module has firmware 29, programming a CTI link on the module is prevented. An earlier or later vintage firmware is supported.

Basic Call Control

A CTI link application on a user's computer can assume basic call control of the user's analog multiline or MLX telephone's SA buttons. Basic call control includes:

- Answering calls arriving on an SA button.
- Making calls from an SA button.
- Hanging up calls.
- Holding and retrieving a call on hold at the user's extension.



NOTE:

Transfer and three-way conference, when handled through a CTI link application, provide the original caller's calling number information or other information to the transfer receiver or new conference participant, if the user has screen-pop capability.

Screen Pop

Screen pop occurs when the calling number, called number, or other user-defined identifier (such as an account code that a voice-response unit prompts the caller to dial) is used to display a screen associated with the far-end party. For example, Caller ID services can be used to support screen pop on a system that includes a CTI link; using the calling party number as a database key code, information about a caller automatically appears on the user's computer screen when the call arrives at the extension. Depending on the application, screen pop may be available for calls that arrive on line buttons other than SA buttons and/or calls that are answered manually at the telephone rather than by the application.

Screen pop can occur on incoming calls from the following sources:

- Calling group distribution.
- ISDN PRI Routing by Dial Plan.
- An extension on the MERLIN LEGEND Communications System.
- Remote access.



NOTE:

In the case of remote access calls, the only information that the application can collect about the caller is the remote telephone number.

- A transfer of a call that was answered by a voice response unit.
- A transfer, redirection, or conference of a call that was answered at a Direct-Line Console (DLC) or at a Queued Call Console (QCC).



NOTES:

- DLCs may use CTI applications. If they do, they perform the same way as other extensions. A DLC assigned to use a CTI link application is a monitored DLC. When a DLC is used as a regular operator console and is not using a CTI link extension, it is non-monitored.
- Calls to a QCC or a DLC not using a CTI application do not initiate screen pop at the operator position. However, when an operator directs a call to an extension using a CTI application, caller information does initiate screen pop. If the DLC is non-monitored, screen pops can occur after the DLC releases the call.
- Calls transferred from Cover buttons on non-monitored DLCs do not initiate screen pop at the destination extension.

HotLine Feature

The Release 5.0 HotLine feature is designed for retail sales, catalogue sales, and other types of businesses and organizations, and is available in all three modes of system operation. It allows a system manager to program a single-line telephone extension connected to an 008 OPT, 012, or 016 module as a HotLine. When a user lifts the handset at the HotLine extension, the telephone automatically dials the inside extension or outside telephone number programmed as the first Personal Speed Dial number (code #01) for the extension. The system does not permit calls to be transferred, put on hold, or conferenced. (A user can press the telephone's Hold button, if it has one, to put a call on local hold, but the call cannot be redirected in any way. Switchhook flashes are ignored.)

Personal Speed Dial codes can be programmed from the extension prior to HotLine assignment (a system programming function). Alternatively, a Personal Speed Dial code can be programmed from the single-line telephone after HotLine operation is assigned. However, because of security considerations, this is a one-time opportunity. Once the Personal Speed Dial number is programmed, any changes to it or any other extension programming must be performed using centralized telephone programming.

Any type of inside or outside line that is normally available to a single-line telephone can be assigned to a HotLine extension. Generally, the HotLine telephone does not receive calls, and its lines should be set to No Ring.



SECURITY ALERT:

If a HotLine extension accesses a loop-start line, that line should provide reliable disconnect and be programmed for reliable disconnect. Otherwise, a user at the extension may be able to stay on the line after a call is completed and then make a toll call.

Group Calling Enhancements

Release 5.0 and later systems include Group Calling features that enhance group calling operations.

Most Idle Hunt Type

In addition to the Circular (factory setting) and Linear hunt types supported in earlier releases, a third hunt type distributes calling group calls in an order based on which agent has waited the longest since transferring or hanging up on an incoming calling group call. For some applications, this hunt type is more efficient than the circular type because it takes into account the varying duration of calls. The system distributes calls based on when an agent last completed a call, not on when he or she last received one. This hunting method ignores non-calling group calls. For example, if an agent transfers a call that arrived on a line not assigned to the calling group, the calling group member's most-idle status is unaffected.

Delay Announcement Devices

The system manager can designate as many as ten primary delay announcement devices per group, rather than the single device for each group that is available in Release 4.2 and earlier systems. Furthermore, an additional secondary delay announcement device can be specified, for a total of ten primary device extensions and one secondary device extension per group.

A primary delay announcement device operates in the same fashion as a single delay announcement device, playing once, as soon as it is available, for the caller who has waited the longest for a calling group agent and has not heard a primary delay announcement. If a secondary announcement device is used, it can use the factory setting, which plays the announcement once, or it can be set to repeat the announcement after a certain amount of time. The system manager programs the time (0–900 seconds) between announcements. This setting controls both the interval between primary and secondary announcements and the interval between repetitions of the secondary announcement, if it is set to repeat. (See "Group Calling Options" in Chapter 4 of *System Planning* for guidelines on setting the delay.)

The primary and secondary announcement options, when used together, allow an initial message to play for callers, followed by a repeating announcement that, for example, urges callers to stay on the line and wait for a calling group member.

Two or more groups may share an announcement device.

A primary delay announcement device can be programmed as a secondary delay announcement device.

Enhanced Calls-in-Queue Alarm Thresholds

Three Calls-in-Queue Alarm thresholds can be set to more clearly indicate the real-time status of the calls waiting in the queue according to the behavior of programmed Calls-in-Queue Alarm buttons. In earlier releases, only one Calls-in-Queue Alarm Threshold setting is available to activate the LEDs at programmed Calls-in-Queue Alarm buttons for a calling group.

Using all three levels, the system manager sets Threshold 3 to the highest value, Threshold 2 to a middle value, and Threshold 1 to the lowest value. A Calls-in-Queue Alarm button indicates the severity of the alarm conditions in the following ways:

- If the number of waiting calls is less than the value programmed for Threshold 1 or drops below that level, the LED is unlit.
- If the number of waiting calls is greater than or equal to the Threshold 1 value but less than the Threshold 2 value, the LED flashes.
- If the number of waiting calls is greater than or equal to the Threshold 2 value but less than the value for Threshold 3, the LED winks.
- If the number of waiting calls is greater than or equal to the highest value, Threshold 3, the LED lights steadily.



NOTE:

A Direct Station Selector (DSS) button that is used as a Calls-in-Queue Alarm button can only indicate two threshold levels, either by flashing or by lighting steadily. If a calling group must use this type of Calls-in-Queue Alarm button, only two threshold levels should be programmed.

If all three thresholds are set to the same value, the result is one threshold only with LED state either off or on (steady). If two values are the same, then the result is two alarm levels (flash, steady). The factory setting is one call for all three thresholds, with LED states of off and steady.

An external alert signals only when the number of calls in the queue meets or exceeds the programmed Threshold 3 value.

MLX-5 and MLX-5D Telephones

The MLX-5 nondisplay and MLX-5D display telephones are compatible with all system releases. The display telephone includes a 2-line by 24-character display, and both telephones come with five line buttons. In systems prior to Release 5.0, the MLX-5 and MLX-5D telephones are treated as MLX-10 and MLX-10D telephones, respectively. As of Release 5.0, the system recognizes the MLX-5 and MLX-5D telephones as 5-button telephones.

If these telephones are connected to communications system releases prior to 5.0, they are recognized by the communications system as 10-button telephones.

Release 4.2 Enhancements **(June 1997)**

Release 4.2 includes all Release 4.1 functionality, plus the enhancements listed below. There are no hardware changes for Release 4.2.

Additional Network Switch and Services Options **for ISDN Primary Rate Interface (PRI)**

Release 4.2 of the system supports connectivity to MCI[®] or local exchange carrier (LEC) PRI services and to the following central office switch types (in addition to the 4ESS[™] and 5ESS[®] switch types that carry AT&T Switched Network services):

- NORTEL[®] DMS[™]-100 BCS 36 for local exchange carrier services.
- NORTEL DMS-250 generic MCI07, serving the MCI network.
- Digital Switch Corporation DEX600E generic 500-39.30, serving the MCI network.

Beginning with Release 4.2, the following MCI PRI and PRI local exchange carrier (LEC) services (along with AT&T Switched Network services) can be provided to users of the MERLIN LEGEND Communications System:

- MCI Toll Services for DMS-250 or DEX600E switch type:
 - MCI Prism[®] service for domestic outgoing long-distance and international voice calls; for domestic outgoing 56-kbps restricted, 64-kbps unrestricted, and 64-kbps restricted circuit-switched data calls.
 - MCI VNet[®] service for incoming and outgoing domestic and voice calls; for 56-kbps restricted, 64-kbps restricted, and 64-kbps unrestricted circuit-switched data calls.
 - MCI 800 for domestic, toll-free incoming voice calls.

- MCI 900 service numbers.
- LEC services for DMS-100 switch types:
 - DMS Virtual Private Network service for calls between the MERLIN LEGEND Communications System and another communications system (such as another MERLIN LEGEND Communications System).
 - DMS INWATS (Inward Wide Area Telephone Service) for domestic toll-free incoming voice calls.
 - DMS OUTWATS (Outward Wide Area Telephone Service) for domestic outgoing long-distance voice calls.
 - DMS FX (foreign exchange) to provide local call rating for calls from the local exchange to the area serviced by the foreign exchange.
 - DMS tie trunk service to provide private exchange call rating for calls placed on a dedicated central office facility between the MERLIN LEGEND Communications System and another communications system (such as another MERLIN LEGEND Communications System).

Improvements to Station Message Detail Recording (SMDR) and Support for MERLIN LEGEND Reporter Application

The SMDR feature is enhanced to provide more details about calling group agent activities and to help system managers assess the effectiveness of call centers in terms of both agent performance and the adequacy of facilities to handle inbound calls. These improvements apply to calling groups that are programmed as Auto Login or Auto Logout type. The SMDR and MERLIN LEGEND Reporter features listed are administrable:

- **TALK Field.** For Auto Login and Auto Logout calling groups, the TALK field records the amount of time a calling group agent spends on a call.
- **DUR. (DURATION) Field.** For Auto Login and Auto Logout calling groups, call timing begins when a call arrives at the MERLIN LEGEND Communications System and not after a preset number of seconds. Call timing ends when the call is disconnected; either the caller or the agent hangs up. This allows the system manager to determine how long a caller waited for an agent's attention.
- **Coding of Calls on Reports.** An asterisk (*) appears in the call record when:
 - A call is not answered by an Auto Login or Auto Logout calling group agent and is abandoned while waiting for an agent.

- The call is answered by someone not a member of an Auto Login or Auto Logout calling group.

An exclamation point (!) signals that an Auto Login or Auto Logout agent handled a call that was answered by someone who was not a member of that Auto Login or Auto Logout with Overflow group. An ampersand (&) in the call record indicates that the group's overflow receiver answered the call.

MERLIN LEGEND Reporter

MERLIN LEGEND Reporter provides basic call accounting system reports for all incoming calls to Auto Login or Auto Logout type calling groups. MERLIN LEGEND Reporter assists in determining the effectiveness of calling group agents, assessing the level of service provided to callers, and ascertaining whether adequate incoming telephone lines and agents are available to handle peak-call load. The SMDR Talk Time option sets up special call records used by MERLIN LEGEND Reporter. The default is off, in which case the Release 4.0 SMDR reports are available. If the option is set to on, the following new reports are provided:

- Organization Detail Report
- Organization Summary and Trends Report
- Selection Detail Report
- Account Code Report
- Traffic Report
- Extension Summary Report
- Data Report
- Talk and Queue Time Distribution Report
- Time of Day Report
- ICLID Call Distribution Report
- Facility Grade-of-Service Report

Maintenance Enhancements

Change to Permanent Error Alarm

Beginning with Release 4.2, the most recent permanent error alarm is not shown on the System Error Log menu screen but is available as an option from that screen. For details, refer to the maintenance section of the technician guide, *Installation, Programming, and Maintenance*.

Enhanced Extension Information Report

Beginning with Release 4.2, the Extension Information Report includes the Extension Status and supervisory mode of each extension.

Release 4.1 Enhancements **(June 1997)**

Release 4.1 includes all Release 4.0 functionality, plus the enhancements listed below. There are no hardware changes in Release 4.1.

Coverage Timers Programmed for Individual Extensions

Beginning with Release 4.1, coverage timers, which control the duration of the delay before calls are sent to each level of coverage, are changed as follows:

- The Group Coverage Ring Delay (1–9 rings) is programmed on individual extensions and replaces the Coverage Delay Interval programmed systemwide in previous releases.
- The Primary Cover Ring Delay (1–6 rings) and Secondary Cover Ring Delay (1–6 rings), programmed on individual extensions, replace the Delay Ring Interval programmed systemwide in previous releases.

These enhancements allow the system manager to customize coverage call delivery to match individual extensions' call-handling requirements.

Night Service with Coverage Control

Beginning with Release 4.1, a system manager can enable the Night Service Coverage Control option to automatically control the status of telephones programmed with Coverage VMS (voice messaging system) Off buttons, according to Night Service status.

When Coverage Control is enabled and the MERLIN LEGEND Communications System is put into Night Service, all programmed Coverage VMS Off buttons are automatically turned off (LED is unlit) and all eligible outside calls are sent to the assigned voice messaging system calling group with normal ringing delay. When Night Service is deactivated during the day, all programmed Coverage VMS Off buttons are automatically turned on (LED is lit) and voice mail coverage is disabled for outside calls.

Users can override the Coverage VMS Off button status at any time by pressing the programmed Coverage VMS Off button to turn the LED on or off.

Night Service Group Line Assignment

Beginning with Release 4.1, a system manager can assign lines to Night Service groups to control handling of after-hours calls received on individual lines. This capability replaces the automatic assignment to Night Service groups of only those lines that ring on the Night Service operator console. An outside line must be assigned to a Night Service group to receive Night Service treatment.

With this enhancement, Night Service can be activated and deactivated on lines that do not appear on operator consoles (for example, personal lines), and lines appearing at operator positions can be excluded from Night Service.

Forward on Busy

Beginning with Release 4.1, the Forward, Follow Me, and Remote Call Forward features are enhanced to remove the requirement that a call be ringing at an extension before it can be forwarded. With the Forward on Busy enhancement, a call to an extension with no available SA or ICOM buttons is forwarded immediately to the programmed destination, preventing the caller from hearing a busy signal from the intended call recipient's extension.

Maintenance Testing for BRI Facilities that Are Part of Multiline Hunt Groups (MLHGs)

Beginning with Release 4.1, the NI-1 BRI (National Integrated Services Digital Network-1 Basic Rate Interface) Provisioning Test Tool is enhanced to include testing for BRI facilities that are part of Multiline Hunt Groups (MLHGs).

The NI-1 BRI Provisioning Test Tool is used by Lucent Technologies maintenance personnel on MERLIN LEGEND Communications Systems that include an 800 NI-BRI module. Technicians use the tool during system installation and maintenance to test the functionality of the BRI lines and to report analyzed results.

Release 4.0 Enhancements (March 1996)

Release 4.0 includes all Release 3.1 functionality, plus the enhancements listed below.

Support for Up to 200 Extensions

An expanded dial plan supports up to 200 tip/ring devices.

Support for National ISDN BRI Service

This service (Hybrid/PBX and Key modes) provides an alternative to loop-start and ground-start lines/trunks for voice and digital data connectivity to the central office. Each of the two B-channels (*bearer channels*) on a BRI line can carry one voice and one data call at any given time. The data speeds on a B-channel are up to 28.8 kbps for analog data and up to 64 kbps for digital data, which is necessary for videoconferencing and other high-speed applications. Release 4.0 supports the ISDN Ordering Code (IOC) Package "S" (basic call handling) service configuration and Multiline Hunt service configuration on designated central office switches.

New Control Unit Modules

Release 4.0 supports a new NI-BRI line/trunk module and a higher-capacity tip/ring module.

800 NI-BRI Module

This new module connects NI-BRI trunks to the MERLIN LEGEND System for voice, high-speed data, and video transmission.

016 Tip/Ring Module

This new module supports a 200-extension dial plan by providing 16 ports for tip/ring devices. Applications that use a tip/ring interface can connect to this board. All 16 ports can ring simultaneously. Four touch-tone receivers (TTRs) are included on the module as well. The module's ringing frequency (default 20 Hz) can be changed, through programming, to 25 Hz for those locations that require it.

Downloadable Firmware for the 016 (T/R) and NI-BRI Modules

The Personal Computer Memory Card International Association (PCMCIA) technology, introduced in Release 3.0, continues to support these two modules for installation and upgrade in Release 4.0. A Release 3.0 or later processor is required for PCMCIA technology.

Support for 2B Data Applications

A Lucent Technologies-certified group and desktop video application can use two B-channels to make video/data calls when connected to a single MLX extension jack programmed for 2B data. The 2B data devices must be equipped with ISDN-BRI interfaces. NI-1 BRI, PRI, or T1 Switched 56 facilities support 2B data communications at 112 kbps (using two 56-kbps channels) or 128 kbps (using two 64-kbps B-channels). This feature is available for Hybrid/PBX and Key modes only.

Support for T1 Switched 56 Digital Data Transmission

For Hybrid/PBX and Key mode systems, Release 4.0 expands support of T1 functionality by providing access to digital data over the public switched 56-kbps network, as well as to digital data tie-trunk services. Users who have T1 facilities for voice services can now use them for video or data calls at rates of 56 kbps per channel (112 kbps for video calls using 2B data). The Release 4.0 offering also includes point-to-point connectivity over T1 tie trunks, allowing customers to connect two MERLIN LEGEND Communications Systems or a MERLIN LEGEND Communications System with a Lucent Technologies DEFINITY G1.1 Communications System or DEFINITY Enterprise Communications Server. The two communications systems can be co-located or can be at different sites.

Forwarding Delay Option

Each user can program a Forwarding Delay setting for the Forward, Remote Call Forwarding, or Follow Me features. The forwarding delay is the number of times that a call rings at the forwarding extension before the call is sent to the receiver. The delay period gives the original call recipient time to answer or to screen calls by checking the displayed calling number (if available). The delay can be set from 0 to 9 rings. The factory setting for the forwarding delay is 0 rings (no delay).

Voice Announce on Queued Call Console

The system manager can enable the fifth Call button on a QCC console (Hybrid/PBX mode only) to announce a call on another user's speakerphone (providing the destination telephone has a voice announce-capable SA button available). A QCC cannot receive voice-announced calls; they are received as ringing calls. The factory-set status for the fifth Call button is voice announce disabled.

Time-Based Option for Overflow on Calling Group

Release 4.0 has added a *time* limit for calls in queue in addition to the previous *number of calls* limit. If the Overflow Threshold Time option is set to a valid number between 1 and 900 seconds, calls that remain in the calling group queue for the set time are sent to the overflow receiver. If the overflow threshold time is set to 0, overflow by time is turned off. The factory-set time limit is 0 seconds (off).

Single-Line Telephone Enhancements

The following changes enhance the performance of single-line telephones:

- **Disable Transfer.** Through centralized telephone programming, the system manager can disable transfer by removing all but one SA or ICOM button from the extension.
- **No Transfer Return.** When a handset bounces in its cradle, the system interprets this as a switchhook flash and attempts to transfer a call. When the transfer attempt period expires, the user's telephone rings. Release 4.0 eliminates this unintended ringing by disconnecting the call in situations where a switchhook flash is followed by an on-hook state and a dial tone is present.
- **Forward Disconnect.** All ports on 008 OPT, 012, and 016 modules now send forward disconnect to all devices connected to them when forward disconnect is received from the central office. This enhancement prevents the trunk/line from being kept active when one end disconnects from the call. If an answering machine is connected to the port, it does not record silence, busy tones, or other useless messages. This operation is not programmable.

Seven-Digit Password for SPM

Release 4.0 has increased system security by requiring a 7-digit password for system managers or technicians who use System Programming and Maintenance (SPM) to perform programming or the Trunk Test procedure. This password is for use in addition to a remote access barrier code.

Release 3.1 Enhancements (March 1996)

Release 3.1 includes all Release 3.0 functionality, plus the enhancements listed below.

Call Restriction Checking for Star Codes

Beginning with Release 3.1, a system manager can add star (*) codes to Allowed and Disallowed Lists to help prevent toll fraud. Star codes, typically dialed before an outgoing call, enable telephone users to obtain special services provided by the central office. For example, in many areas, a telephone user can dial *67 before a telephone number to disable central office-supplied caller identification at the receiving party's telephone. You must contract with your telephone service provider to have these codes activated.

When users dial star codes, the system's calling restrictions determine whether the codes are allowed. If they are allowed, the system's calling restrictions are reset, and the remaining digits that the users dial are checked against the calling restrictions.

Trunk-to-Trunk Transfer Set for Each Extension

This enhancement to the Transfer feature enables the system manager to allow or disallow trunk-to-trunk transfer on a per-extension basis. In Release 3.1 and later systems, the default setting for all extensions is restricted.

Programmable Second Dial Tone Timer

The system manager can assign a second dial tone timer to lines/trunks, in order to help prevent toll fraud (for example, when star codes are used). After receiving certain digits dialed by a user, the central office may provide a second dial tone, prompting the user to enter more digits. If this second dial tone is delayed, and the user dials digits before the central office provides the second dial tone, there is a risk of toll fraud or misrouting the call. The second dial tone timer enables the system manager to make sure that the central office is ready to receive more digits from the caller.

Security Enhancements

The sections below outline security measures that are implemented in Release 3.1 and later systems.

Disallowed List Including Numbers Often Associated with Toll Fraud

A factory-set Disallowed List 7 contains default entries, which are numbers frequently associated with toll fraud. By default, Disallowed List 7 is automatically assigned to both generic and integrated voice messaging interface (VMI) ports used by voice messaging systems. The system manager can manually assign this list to other extensions.

Default Pool Dial-Out Code Restriction for All Extensions

The default setting for the pool dial-out code restriction (Hybrid/PBX mode only) is restricted. No extension or remote access user with a barrier code has access to pools until the restriction is removed by the system manager.

Default Outward Restrictions for VMI Ports

Ports assigned for use by voice messaging systems (generic or integrated VMI ports) are now assigned outward restrictions by default. If a voice messaging system must be allowed to call out (for example, to send calls to a user's home office), the system manager must remove these restrictions.



SECURITY ALERT:

Before removing restrictions, it is strongly recommended that you read [Appendix A, "Customer Support Information,"](#) in System Programming.

Default Facility Restriction Level (FRL) for VMI Ports

The default Automatic Route Selection (ARS) FRL for VMI ports is 0, restricting all outcalling.

Default for the Default Local Table

The default Automatic Route Selection (Hybrid/PBX mode only) FRL has changed to 2 for the Default Local table. System managers can easily change an extension's default FRL of 3 to 2 or lower to restrict calling. No adjustment to the route FRL is required.

New Maintenance Procedure for Testing Outgoing Trunks

Technicians must enter a password in order to perform trunk tests.



SECURITY ALERT:

The enhancements in Release 3.1 help increase the security of the MERLIN LEGEND System. To fully utilize these security enhancements, be sure to read and understand the information in these upgrade notes and in the relevant system guides.

Release 3.0 Enhancements (August 1994)

Release 3.0 includes all Release 2.1 functionality plus the enhancements listed below.

Equipment

New hardware includes a variety of components. Additional details are included elsewhere in this book.

- CPU modifications include:
 - A processor running at 16 MHz with a 32-bit wide data bus.
 - 1.5 MB of non-volatile (battery-backed) RAM.
 - 4.0 MB of Flash ROM.
 - PCMCIA memory card interface.
 - A full-duplex 1200/2400 bps modem.
 - Error/Status code display for maintenance support.
- An 800 GS/LS-ID line/trunk module delivers the calling party's telephone number to the customer premises (MLX display telephones only) if the service is subscribed to by the customer and if it is supported by the caller's telephone company.
- Support for:
 - MDC 9000 (six-line, cordless).
 - MDW 9000 (six-line, cordless, wireless).
 - 8101 (single-line telephone, desk or wall-mount, data/fax jack, selectable positive disconnect).

- 2500YMGL and 2500 MMGL (single-line desk telephones, selectable positive disconnect).
 - Picasso™ Still-Image telephone (for interactive display of still images).
 - Videophone 2500 single-line telephone with interactive video display
- Pre-fabricated and pre-drilled backboard.

Installation, Upgrade Administration, and Maintenance

These are the new MERLIN LEGEND Communications System capabilities:

- SPM (Release 3.18) conversion of translations from Release 1.0, 1.1, 2.0, and 2.1 to 3.0.
- Remote operation at 1200/2400bps.
- Advice and feedback administration screens for new Release 3.0 functionality.
- PCMCIA Memory Card Interface (a Release 3.0 processor board required) allowing:
 - System software installation.
 - System software upgrade.
 - 800 GS/LS-ID port module firmware upgrade.
 - Integrated backup and restore of translations.
 - Automatic and manual options for backup and restore are available on the system. Automatic backup can be scheduled weekly or daily to fit the customer's needs.
- Inter-digit dialing timer values are programmable.
- Inspection of Lines/Trunks displays only those lines and trunks configured on system rather than all 80 facilities.
- Extensions and facilities in Maintenance Busy (both manual and automatic) can be identified by the maintenance monitor.

User Features

Security

The Remote Access feature allows people at remote locations to enter the system by dialing the number of a line or trunk designated for remote access. The system can be programmed to require the remote user to dial a barrier code (a type of password) after reaching the system. In earlier versions, the systemwide barrier code length is fixed at four digits. Release 3.0 allows a systemwide barrier code length ranging from a minimum of four digits to a maximum of 11 digits, with a factory setting of seven digits. SMDR records are enhanced to provide information for remote access calls. If the remote access call is received on a facility providing Caller ID information (see below), the SMDR report can help trace the call.

Caller ID

Caller information (telephone number) is furnished to MLX display telephones by an 800 GS/LS-ID module using the LS (loop-start) option. This allows customers to screen calls before answering the telephone, as well as providing calling party information for use with various applications. This function is available only when the customer subscribes to caller identification service from the telephone company, if the telephone company supports that service.

Shared System Access (SSA)

A telephone may have up to 27 Shared SA buttons to expand extension coverage.

Authorization Codes

The Authorization Code feature allows you to make calls using your calling privileges when you are dialing from an extension other than your own. When you enter your authorization code (ranging from 2 to 11 characters and unique across the system), the privileges and restrictions assigned to your home extension override the current restrictions at the host extension. This includes toll restriction, outward restriction, Facility Restriction Level (FRL), Allowed Lists, Disallowed Lists, Night Service Exclusion List, and Dial Access to Pools. All other functions on the telephone are those of the local telephone, not the home extension.

Authorization codes can also be used for the purpose of call accounting through the SMDR printout. The SMDR account code field can hold either the authorization code extension number or the authorization code itself.

Direct Voice Mail

If your company has voice mail, this feature allows you to dial a co-worker's voice mailbox directly without ringing that person's extension. Direct Voice Mail is especially useful for transferring calls when a co-worker is not available.

Additional Features

The status of Leave Word Calling (LWC) and Privacy are retained across cold starts.

Caller ID (CLASSSM ICLID and PRI) are available on primary coverage and return from transfer.

Additional Application Packages, Adjuncts, and Adapter Enhancements

PassageWay Direct Connection Solution

PassageWay Direct Connection Solution (Release 2.0) is a computer telephony integrated product that links a desktop Microsoft® Windows®-based PC to the MERLIN LEGEND Communication System's MLX-10DP, MLX-20L, or MLX-28D telephone. The Windows applications are: AT&T Call (autodial/contact manager), AT&T Buzz (screen-pop applications), AT&T Set (extension programming interface), and Log Viewer (call log application). PassageWay Direct Connection Solution (Release 2.0) is the version supported on MERLIN LEGEND Communications System Release 3.0.

PagePal™

PagePal connects several paging systems to the MERLIN LEGEND Communications System. No other system adapter is necessary for loudspeaker paging.

Fax Attendant 2.1.1

Fax Attendant Release 2.1.1, which co-resides with AUDIX Voice Power on the IS III Release 1.2 platform, provides the same functionality as earlier versions, plus the following enhancements:

- **Personal Fax Messaging.** Inbound faxes can be stored until the subscriber asks that they be printed, at any fax machine he or she specifies, on company premises or offsite (when the subscriber retrieves fax messages remotely).

- **Fax Mail.** Allows subscribers to send fax messages, get fax messages, record personal greetings, and program outcalling.
- **Fax Broadcast.** Provides a simple way to send one fax to as many as 1000 fax numbers.

Call Accounting System (CAS) for Windows

This stand-alone version of CAS takes advantage of the easy-to-use graphical environment offered by Microsoft Windows. Through data communications, it also allows one CAS system to serve multiple business sites.

Group Videoconferencing

Group videoconferencing is supported over DS1 (Digital Signal Level 1) facilities with PRI. (Videoconferencing has been available since Release 2.0.)

Release 2.1 Enhancements (August 1994)

Refer to *Release 2.1 Notes* for detailed descriptions of Release 2.1 enhancements. Release 2.1 includes all Release 2.0 functionality plus the enhancements listed below.

Operational

System operational enhancements include the following:

- When a call is forwarded to a multiline telephone that has an Auto Dial or DSS button programmed for the forwarding telephone, the green light next to the Auto Dial or DSS button for the forwarding telephone does not flash.
- People answering calls received on Cover buttons are allowed to generate touch tones if their telephones are not outward- or toll-restricted.
- Calls received on personal lines with Do Not Disturb on go immediately to coverage instead of waiting for the coverage delay interval.
- A call put on hold at a Cover button can be added to a conference by someone who has a personal line for the call.
- A call put on hold at a Cover button can be picked up by any person who has a personal line for the call.
- Calls that have been put on hold at a Cover, SA, Shared SA, or Pool button can be picked up by a person who has a personal line button for the call.

- An inside call on hold at an SA button can be picked up and transferred by any person with a Shared SA button corresponding to the button with the held call.
- Calls that are on hold awaiting transfer can be picked up by any user who has a personal line for the call.
- Beginning with Integrated Solution III Version 1.2, the automatic reconciliation program that was run automatically at 3:00 a.m. is disabled and can be invoked manually from the User Maintenance menu.
- If an extension is programmed for Forced Account Code Entry, account codes do not have to be entered when using a programmed Loudspeaker Paging button. In addition, an SMDR record is not generated for calls made to paging ports.
- When an MLX telephone, other than an MLX-20L, is plugged into an MLX port and the Personal Directory does not contain any entries, the allocation of the Personal Directory resource is released. If there are any entries in the Personal Directory, the Personal Directory allocation and the entries in the Personal Directory are saved in the MLX port.
- SMDR call records for calls made on PRI facilities are more accurate than SMDR call records for calls made on non-PRI facilities. Outgoing calls made on PRI facilities receive "answer supervision." Consequently, SMDR timing for calls made on PRI facilities begins when the call is answered. Timing for calls made on non-PRI facilities begins when dialing is completed. Therefore, an SMDR call record is not generated when a call made on a PRI facility is not answered at the far end.
- The Call Type field and the Called Number field on the SMDR report are changed for both the Basic and ISDN report formats.
- An 012 port that is programmed as a generic voice messaging interface (VMI) port can transfer an outside call to an outside number.
- In a system where the transfer audible option is programmed for Music-On-Hold and a music source is provided, outside callers who are transferred to a calling group and are waiting in the queue or who are parked or camped-on, hear music while they are waiting. Internal callers never hear music on hold while waiting in the calling group queue or when they are parked, camped-on, or being transferred to another extension.

Installation and Hardware

Installation and hardware enhancements include the following:

- The control unit covers for the MERLIN LEGEND Communications System are the same easy-to-use covers as those for the MERLIN II Communications System.

- A new 012 (tip/ring) module [apparatus code 517G13 (28) or higher letter] contains a built-in ring generator. The maximum ring equivalency number (REN) supported is 2.2, and the module will ring four ports at one time. Bridging of single-line telephones is not supported because of poor transmission quality.
- A new 008 OPT module (labeled "with RING GEN.") contains a built-in ring generator. It rings four ports at a time.
- Ferrite cores for the power supply modules are shipped from the factory to comply with FCC Part 15 requirements.
- 3129-WTWA (touch tone outdoor telephone equipped with cast aluminum housing and armored handset cord with bell ringers)
- 3129-WRWA (rotary dial outdoor telephone equipped with cast aluminum housing and armored handset cord with bell ringers).
- 3129-WAWA (auto dial outdoor telephone equipped with cast aluminum housing and armored handset cord with bell ringers).
- 3129-WNWA (nondial, automatic ringing on dedicated circuit outdoor telephone equipped with cast aluminum housing and armored handset cord with bell ringers).

Equipment and Operations

Equipment and operations enhancements include the following:

- A new release (Version 2.16) of the System Programming and Maintenance (SPM) software to support international use.
- Support of PRI connection to DEFINITY, Communications Systems
- MLX-10DP telephone, identical to an MLX-10D, except that it provides a jack for access to the PassageWay™ Solution and PassageWay Direct Connection Solution application.

Additional Application Packages, Telephones, Adjuncts, and Adapter

Additional application packages, adjuncts, and adapter enhancements include the following:

- A Digital Announcer Unit, compatible with all call management systems and tip/ring applications currently available for the MERLIN LEGEND Communications System.
- The HackerTracker™ system software enhancement to the Call Accounting System (CAS) detects abnormal calling activity by allowing monitoring of facilities or authorization code usage.

- A new digital Magic On Hold unit is available in three configurations:
 - Basic Prerecorded Package
 - Personalized Package
 - Custom Production Package
- The MERLIN® Identifier application enables people to receive, store, and use information provided by the local telephone company, specifically, the telephone number of a caller in an area where the service is also supported.
- An Off-Premises Range Extender (OPRE) supports off-premises operation with an off-premises extension capability and extended range operation for tip/ring devices as well as variable gain to improve voice transmission levels.
- PagePac® Plus Loudspeaker Paging Systems do not require system adapters. The controller provides eight built-in zones (expandable to 56 zones by using up to three 16-zone expansion units), group zones, talkback, night bell, operator override, tones, door supervision, microphone input, and system access security codes as standard features.
- PassageWay Solution (Release 1.0) software consisting of four applications that run with Microsoft® Windows™ 3.1 or later and provide an interface between an IBM®-compatible personal computer and the MERLIN LEGEND Communications System.
- Four single-line telephones with memory buttons: 710, 715, 725, and 730.
- Four specialty handsets compatible with all MLX telephones and the 3101 series, 3178-NHL, 8102, and 8110 single-line telephones.

Release 2.0 Enhancements **(October 1992)**

Refer to *Release 2.0 Notes* for detailed descriptions of Release 2.0 enhancements. Release 2.0 includes all Release 1.1 functionality plus the enhancements listed below.

Programming

Programming enhancements include the following:

- Extension Copy is a feature that reduces programming time by allowing the use of any extension as a template for programming another extension or block of extensions through centralized telephone programming.

- Integrated Administration provides a single interface through Integrated Solution III (IS III) for programming entries common to the MERLIN LEGEND Communications System and AUDIX™ Voice Power.
- Any SPM Version 2.xx (where xx is replaced by numbers) provides a Convert function for use in upgrading the system from Release 1.0 or 1.1. This function converts a backup file from a Release 1.0 or 1.1 system to Release 2.0 and later format, allowing reuse of existing system programming on the upgraded system.
- Forced idle reductions keep system interruptions at a minimum. In general, the smallest necessary component is forced idle during programming activities. For example, renumbering a single extension idles only one extension. Only a few systemwide programming activities, such as setting the system mode and system renumbering, idle the entire system.

Operational

System operational enhancements include the following:

- Coverage VMS Off is a feature that prevents incoming outside calls from going to voice mail. (All other coverage remains active as programmed.) The feature is programmed extension by extension, either through extension programming or through centralized telephone programming.
- A Night Service group can be programmed to include either extensions or a calling group as members. You should not program both individual extensions and a calling group into the Night Service group, however, because individuals will not have a chance to answer before calling group members do.
- When AUDIX Voice Power sends a Leave Message notification to an extension, the system identifies the voice mail system as the sender of the message. When the voice mail subscriber uses the Return Call feature, the call goes to any available voice mail port, not just to the specific port that generated the message. This reduces the chance of getting a busy port.
- Coverage receivers can call coverage senders and have the call receive coverage treatment. If a receiver calls a sender for whom he or she is covering, and the sender is busy or unavailable, the call proceeds to other points of coverage. It does not come back to the receiver who originated the call.
- Enhancements to display prompts include automatic posting of a Do Not Disturb message (for MLX display telephones or other multiline telephones, a Posted Message button must be programmed for the Do Not Disturb message to be posted automatically) when a user activates the Do Not Disturb feature, and confirmation messages when a user activates Hold, Privacy, Saved Number Dial, and Transfer.

- Direct Inward Dialing (DID) trunk emulation on a T1 facility provides up to 24 DID channels on a single DS1 interface, instead of requiring 24 separate physical trunks.
- A telephone user can send a timed flash (switchhook flash) on a loop-start trunk call on a System Access (SA) button.

Fax Attendant System™

Fax Attendant is an application for sending and receiving fax messages; its interface is similar to the voice mail interface provided by AUDIX Voice Power. Fax Attendant System, which co-resides with AUDIX Voice Power on the IS III platform, provides the following services:

- **Fax Call Coverage.** Receives and holds messages for subscribers whose fax machines are busy or out of paper. This service also allows a subscriber to have a personal fax number without having a fax machine.
- **Fax Mail.** Allows subscribers to create and use fax distribution lists, send and receive fax messages, and record personal greetings for incoming fax calls.
- **Fax Response.** Prompts callers to select and receive faxes from a customer-created menu of choices, using touch-tone responses.

408 GS/LS-MLX Module

The 408 GS/LS-MLX module (Releases 2.0 and later only) combines four line/trunk jacks for ground-start or loop-start trunks and eight extension jacks for MLX telephones on a single module in the control unit.

Primary Rate Interface (PRI)

Primary Rate Interface (PRI) enhancements include the following:

- Connectivity to the 5ESS® Generic 6
- Multiple incoming calls to directory number
- Call-by-Call Service Selection
- Password handling for FTS2000
- Extension ID as Calling Party Number for Automatic Number ID (ANI)

Maintenance

Maintenance enhancements include the following:

- Clear descriptions of module test failures
- Optional printing of hard copy of error logs
- Display that correlates extension numbers with slot/port and logical ID
- Display showing which slots, trunks, and extensions are maintenance busy
- Internal digital switching element (DSE) loopback test for all modules
- B-channel loopback test for MLX modules
- B-channel line or call service states display
- Error log entries for dual-port RAM errors

Release 1.1 Enhancements **(October 1992)**

Refer to *Release 1.1 Notes* for detailed descriptions of Release 1.1 enhancements. Release 1.1 includes all Release 1.0 functionality plus the enhancements described in the following sections.

Language Selection

This selection allows you to program the system for the display of prompts, menus, and messages on MLX display telephones in English, French, or Spanish. You can also program the following options in any of these languages, independently of the system language:

- Individual extensions with MLX telephones
- System Programming and Maintenance (SPM)
- System programming reports
- SMDR report headers

MLX-10D, MLX-20L, and MLX-28D display telephones and MLX-10 nondisplay telephones are available in three separate versions, with factory-set buttons in English, Spanish, or French. (The MLX-10DP is available in the English version only.) In addition, user and operator guides and telephone tray cards are available in all three languages.

Programming and Maintenance

Programming and maintenance enhancements include the following:

- Additional Inspect capability in system programming.
- Editing capability (Backspace selection) in extension programming.
- Improvements to system reports.
- An access log that records the last 20 times maintenance or system programming has been accessed.
- Longer (20-second) gap between ring cycles for programming mode and Forced Idle tone.

Operational

System operational enhancements include the following:

- Automatic selection of an SA button when Conference is invoked (Hybrid/PBX mode).
- Prompting through Conference feature on MLX display telephones.
- Relocation of the More prompt on the MLX-20L display.
- Display of the number saved on a programmed Last Number Dial or Saved Number Dial button when the button is inspected.

SPM

SPM enhancements include operation in English, French, or Spanish, faster backup and restore, and automatic onscreen display of reports as they are created, with a Browse capability for reading the reports.

Equipment

Additional equipment includes the 8102 and 8110 analog telephones, four headsets, two headset amplifiers, and a transparent protective cover for the MLX-10 and MLX-10D telephones. The 8102 and 8110 telephones are also compatible with Release 1.0.

PF Registration

PF registration number AS5USA-65646-PF-E is assigned by the FCC for operating the MERLIN LEGEND Communications System in Hybrid/PBX mode in the United States. (The PF registration is also applicable to Release 1.0 systems.)

About This Guide

The MERLIN LEGEND Communications System is an advanced digital switching system that integrates voice and data communications features. Voice features include traditional telephone features, such as Transfer and Hold, and advanced features, such as Group Coverage, Direct Voice Mail, and Tandem Switching. Data features allow both voice and data to be transmitted over the same system wiring.

Intended Audience

This book provides detailed information about system features, extension features, and system applications in Release 7.0 of the MERLIN LEGEND Communications System. It is intended as a reference for anyone needing such information, including support personnel, sales representatives, system managers, and account executives. It is also intended for technicians who are responsible for system installation, maintenance, and troubleshooting.

How to Use This Guide

The section entitled [“Index of Feature Names” on page 2](#) is provided to help you to find the appropriate feature name for the function that you want described. You can then quickly find the description of the feature or features using the page numbers provided. If you do not know the name of a feature that interests you, the [“Index of Features by Activity” on page 14](#) provides a list of functions and the features that provide them, along with the page numbers where you can find descriptions.

Each entry in the guide explains a feature or set of features in great detail.

“At a Glance,” a boxed table at the beginning of each feature description, summarizes, as applicable, the following aspects of the feature or feature group:

- **Users Affected.** Shows what category of users is affected by a feature. For example, “Auto Dial” lists telephone users and Direct-Line Console (DLC) operators as those affected by the feature. (From this you can conclude that Queued Call Console (QCC) operators cannot use Auto Dial.)
- **Reports Affected.** Cites the Station Message Detail Recording (SMDR) reports in which you can find information relating to the feature.
- **Modes.** Lists the system operating mode or modes in which the feature is used.
- **Telephones.** Tells you which telephones support the feature.
- **Programming Code(s).** As appropriate, lists the programming code(s) used to program the feature on a button or to turn it on or off.
- **Feature Code(s).** Lists the feature code(s) you can use to activate the feature or turn it off.
- **MLX Display Label(s).** Lists the name as it appears on the MLX-20L[®] and/or other MLX telephones.
- **System Programming.** If applicable, summarizes the system programming procedure(s) that control the feature.
- **Maximum(s).** If applicable, tells you what maximum numbers apply to the feature.
- **Factory Setting(s).** Shows you the default programming, that is, how the system sets the feature when no one programs it.

Following each “At a Glance” table is a full description of the feature or feature group, telling you how it works for those who have different types of equipment or programmed positions. Following the description, feature entries include (as applicable) each of these sections:

- **Considerations and Constraints.** An explanation of exceptions and unusual conditions pertaining to the feature. This section can help you troubleshoot a problem with the feature.
- **Mode Differences.** An explanation of variations in the use of the feature in the different modes supported by the system.
- **Telephone Differences.** An explanation of variations in the use of the feature with different telephones.
- **Feature Interactions.** A list of issues and considerations to be aware of when using another feature in conjunction with the main feature described. The list is arranged alphabetically by feature.

[“Related Documents” on page Ixiv](#) provides a complete list of system documentation together with ordering information.

In the USA only, Lucent Technologies provides a toll-free customer Helpline 24 hours a day. Call the Helpline at 1-800-628-2888 (consultation charges may apply), or contact your Lucent Technologies representative if you need assistance when installing, programming, or using your system.

Outside the USA, if you need assistance when installing, programming, or using your system, contact your Lucent Technologies authorized representative.

Terms and Conventions Used

The terms described here are used in preference to other, equally acceptable terms for describing communications systems.

Lines, Trunks, and Facilities

Facility is a general term that designates a communications path between a telephone system and the telephone company central office. Technically, a *trunk* connects a switch to a switch—for example, the MERLIN LEGEND Communications System to the central office. Technically, a *line* is a loop-start facility or a communications path that does not connect switches—for example, an intercom line or a Centrex line. In actual usage, however, the terms *line* and *trunk* are often applied interchangeably. In this guide, we use *line/trunk* and *lines/trunks* to refer to facilities in general. Specifically, we refer to *digital facilities*. We also use specific terms such as *personal line*, *ground-start trunk*, *Direct Inward Dialing (DID) trunk*, and so on. When you talk to personnel at your local telephone company central office, ask them which terms they use for the specific facilities they connect to your system.

Some older terms have been replaced with newer terms, as follows:

Old Term	New Term
trunk module	line/trunk module
trunk jack	line/trunk jack
station	extension
station jack	extension jack
analog data station	modem data workstation
digital data station	terminal adapter workstation
7500B data station	ISDN terminal adapter data workstation

Old Term	New Term
analog voice and analog data station	analog voice and modem data workstation
digital voice and analog data station	MLX voice and modem data workstation
analog data-only station	modem data-only workstation
digital data-only station	terminal adapter data-only workstation
7500B data-only station	ISDN terminal adapter data-only workstation
digital voice and digital data station	MLX voice and terminal adapter workstation
MLX voice and 7500B data station	MLX voice and ISDN terminal adapter data workstation

Typographical Conventions

Certain type fonts and styles act as visual cues to help you rapidly understand the information presented:

Convention	Example
Italics or bold indicate emphasis.	It is <i>very</i> important that you follow these steps. WARNING: Do not remove modules from the carrier without following proper procedures.
Italics also set off special terms.	The part of the headset that fits over one or both ears is called a <i>headpiece</i> .
Plain constant-width type indicates text that appears on the telephone display or PC screen, as well as characters you dial at the telephone or type at the PC.	Choose <code>Ext Prog</code> from the display screen. To activate Call Waiting, dial <code>*11</code> .

Product Safety Advisories

Throughout these documents, hazardous situations are indicated by an exclamation point inside a triangle and the word *CAUTION* or *WARNING*.



WARNING:

Warning indicates the presence of a hazard that could cause death or severe personal injury if the hazard is not avoided.



CAUTION:

Caution indicates the presence of a hazard that could cause minor personal injury or property damage if the hazard is not avoided.

Security

Certain features of the system can be protected by passwords to prevent unauthorized users from abusing the system. You should assign passwords wherever possible and limit distribution of such passwords to three or fewer people.

Nondisplaying authorization codes and telephone numbers provide another layer of security. For more information, see [Appendix A, "Customer Support Information."](#)

Throughout this guide, toll fraud security hazards are indicated by an exclamation point inside a triangle and the words *SECURITY ALERT*.



SECURITY ALERT:

Security Alert indicates the presence of a toll fraud security hazard. Toll fraud is the unauthorized use of your telecommunications system, or use by an unauthorized party (e.g., persons other than your company's employees, agents, subcontractors, or persons working on your company's behalf). Be sure to read "[Your Responsibility for Your System's Security](#)" on the inside front cover of this guide and "[Security of Your System: Preventing Toll Fraud](#)" in [Appendix A, "Customer Support Information."](#)

Related Documents

The documents listed in the following table are part of the MERLIN LEGEND documentation set. Within the continental United States, contact the Lucent Technologies BCS Publications Center by calling 1-800-457-1235.

Document No.	Title
System Documents:	
555-670-100	<i>Customer Documentation Package:</i> Consists of paper versions of the <i>System Manager's Quick Reference</i> , the <i>Feature Reference</i> , and <i>System Programming</i>
555-670-110	<i>Feature Reference</i>
555-670-111	<i>System Programming</i>
555-670-112	<i>System Planning</i>
555-670-113	<i>System Planning Forms</i>
555-670-116	<i>Pocket Reference</i>
555-670-119	<i>System Manager's Quick Reference</i>
555-661-150	<i>Network Reference</i>
555-670-800	<i>Customer Reference CD-ROM:</i> Consists of the <i>System Manager's Quick Reference</i> , the <i>Feature Reference</i> , <i>System Programming</i> , and the <i>Network Reference</i>
Telephone User Support:	
555-660-122	<i>MLX Display Telephone User's Guide</i>
555-630-150	<i>MLX-5D, MLX-10D and MLX-10DP Display Telephone Tray Cards (5 cards)</i>
555-630-152	<i>MLX-28D and MLX-20L Telephone Tray Cards (5 cards)</i>
555-660-124	<i>MLX-5[®] and MLX-10[®] Nondisplay Telephone User's Guide</i>
555-630-151	<i>MLX-5 and MLX-10 Nondisplay Telephone Tray Cards (6 cards)</i>
555-630-155	<i>MLX-16DP Display Telephone Tray Cards (5 cards)</i>
555-660-120	<i>Analog Multiline Telephones User's Guide</i>
555-670-122	<i>MLS and ETR Telephone Tray Cards</i>
555-660-126	<i>Single-Line Telephones User's Guide</i>

Document No.	Title
555-660-138	<i>MDC and MDW Telephones User's Guide</i>
System Operator Support:	
555-660-134	<i>MLX Direct-Line Consoles Operator's Guide</i>
555-660-132	<i>Analog Direct-Line Consoles Operator's Guide</i>
555-660-136	<i>MLX Queued Call Console Operator's Guide</i>
Miscellaneous User Support:	
555-661-130	<i>Calling Group Supervisor and Service Observer User Guide</i>
555-650-105	<i>Data and Video Reference</i>
Documentation for Qualified Technicians:	
555-670-140ADD	<i>Installation, SPM, Maintenance and Troubleshooting Supplement</i>
Toll Fraud Security:	
555-025-600	<i>BCS Products Security Handbook</i>

How to Comment on This Guide

We welcome your comments, both positive and negative. Please use the feedback form on the next page to let us know how we can continue to serve you. If the feedback form is missing, write directly to:

Documentation Manager
Lucent Technologies
211 Mount Airy Road, Room 2W-330
Basking Ridge, NJ 07920

Features

Overview

This guide provides both summary and detailed information about the features of the MERLIN LEGEND Communications System. For each feature, the following types of information are provided, as applicable:

- **At a Glance.** Summary information about the feature, including users affected, telephones supported, programming codes, and factory settings.
- **Description.** A detailed description of the functions/uses of the feature.
- **Considerations and Constraints.** An explanation of exceptions and unusual conditions pertaining to the feature.
- **Mode Differences.** An explanation of variations in the use of the feature in the different modes supported by the communications system.
- **Telephone Differences.** An explanation of variations in the use of the feature with different telephones.
- **Feature Interactions.** A list of issues and considerations that you should know about when using one feature in conjunction with another.

For easy reference, features are covered in alphabetical order. The [“Index of Feature Names,”](#) which follows, shows where information can be found about features and other system components that may have been renamed or reorganized in this release of the communications system and related products. The [“Index of Features by Activity”](#) section, beginning on [page 14](#), presents tables listing features according to tasks typically performed with the system. Use these, or the index at the back of the book, when you are not sure which entry you should consult.

Index of Feature Names

Feature Name...	See...	Page #...
#		
2B Data	Digital Data Calls. See also <i>Data/Video Reference</i>	223
A		
Administration	Programming See also <i>System Programming</i>	557
Alarm	Alarm	37
Alarm Clock	Alarm Clock	40
Allowed Lists	Allowed/Disallowed Lists Night Service	42 458
Area Code Tables	Automatic Route Selection	77
Attendant Barge-In	Barge-In	95
Attendant DSS	Direct Station Selector	240
Attendant Message Waiting	Messaging	429
Attendant Console—Display	Display	271
Attendant Console—Switched Loop	Queued Call Console	565
Authorization Code	Authorization Code	49
Auto Answer—All	Auto Answer All	56
Auto Answer—Intercom	Auto Answer Intercom	59
Auto Dial	Auto Dial	62
Auto intercom	Auto Answer Intercom	59
Auto Login/Logout (Calling Group)	Group Calling Extension Status	350 317
Automatic Answer (Data Management)	Auto Answer All	56
Automatic Callback	Callback Remote Access	116 602
Automatic Completion	Transfer	723
Automatic Extended Call Completion	Queued Call Console	565
Automatic Hold or Release	Queued Call Console Hold	565 395
Automatic Line Selection	Automatic Line Selection and Ringing/Idle Line Preference	69
Automatic Maintenance Busy	Automatic Maintenance Busy	75
Automatic Route Selection (ARS)	Automatic Route Selection	77

Feature Name...	See...	Page #...
Automatic Route Selection (ARS) over Private Networks	Automatic Route Selection and Tandem Switching See also <i>Network Reference</i>	77 699
Autoqueuing	Callback Remote Access	116 602

B

Barge-In	Barge-In	95
Barrier Codes	Remote Access	602
Basic Rate Interface	Basic Rate Interface See also <i>Data/Video Reference</i>	99
Behind Switch Operation	Recall/Timed Flash Centrex Operation	590 145
Bridging of Station Lines on Multiline Telephones	Personal Lines, System Access/Intercom Buttons	484 , 673

C

Call Accounting System (CAS)	Appendix I	17
Call Accounting Terminal (CAT)	Appendix I	20
Call-by-Call Services Table	Primary Rate Interface (PRI) and T1 See also <i>Data/Video Reference</i>	509
Call Completion	Transfer, One-Touch	723
Call Coverage	Coverage	170
Call Forward(ing)/Follow me	Forward and Follow Me	326
Call Park	Park	479
Call Pickup	Pickup	494
Call Pickup—Directed	Pickup	494
Call Pickup—Group	Pickup	494
Call Records	Station Messaging Detail Recording (SMDR)	655
Call Restrictions	Calling Restrictions	132
Call Waiting	Call Waiting	110
Callback	Callback	116
Callback Queuing	Callback	116
Caller ID	Caller ID	125
Calling Group	Group Calling	350
Calls-in-Queue Alarm	Group Calling Queued Call Console	350 565

Feature Name...	See...	Page #...
Camp-On	Camp-On	-140
Cancel Delivered Message	Messaging	429
CAT (Call Accounting Terminal)	Appendix I	20
Centralized Telephone Programming	Programming See also <i>System Programming</i>	557
Centralized Voice Messaging	Centralized Voice Messaging See also <i>Network Reference</i>	144
Centrex	Centrex Operation	145
Centrex Transfer via Remote Call Forwarding	Forward and Follow Me	326
Class of Restriction	Remote Access	602
Computer Telephony Integration	CTI Link	208
Conference	Conference	158
Consultation Transfer	Transfer	723
CONVERSANT [®]	Appendix I	32
Coverage Delay Interval	Coverage	170
Coverage Group	Coverage	170
Coverage Inhibit	Coverage	170
Coverage On/Off	Coverage	170
Coverage	Coverage	170

D

Data Hunt Groups	See <i>Data/Video Reference</i>	
Data Privacy	Privacy See also <i>Data/Video Reference</i>	553
Data Status	See <i>Data/Video Reference</i>	
Data Transmission Speed	See <i>Data/Video Reference</i>	
Default Local and Toll Tables	Automatic Route Selection	77
Delay Announcement	Group Calling	350
Delay Ring	Ringing Options	618
Delete Message	Messaging	429
Deliver Message	Messaging	429
Dial by Name (Display Feature)	Directories	263
Dial Plan	System Renumbering	685
Dial Plan: Non-Local	Uniform Dial Plan (UDP) Features See also <i>Network Reference</i>	741
Dialed Number	Display	271

Feature Name...	See...	Page #...
Digital Data Ports	Digital Data Calls See also <i>Data/Video Reference</i>	223
Dial-Plan Routing Table	Primary Rate Interface (PRI) and T1 See also <i>Data/Video Reference</i>	509
Dial Tone	Inside Dial Tone	409
Digits in Extension	System Renumbering	685
Direct Dept. Calling (Hunting, Hunt Groups)	Group Calling	350
Direct Facility Termination (DFT)	Personal Lines	484
Direct Group Calling (DGC)	Group Calling	350
Direct Inward System Access (DISA)	Remote Access	602
Direct-Line Console	Direct-Line Console	231
Direct Pool Termination (DPT)	Pools	500
Direct Station Selector	Direct Station Selector	240
Direct Voice Mail	Direct Voice Mail	260
Directory Built into PBX	Directories	263
Directory of System Speed Dial Numbers	Speed Dial	648
Directory of Extension Numbers	Directories	263
Disallowed Lists	Allowed/Disallowed Lists	42
Display	Display	271
Display Preference	Display	271
Display of Name Associated with Station	Labeling	413
Display Prompting	Display	271
Distinctive Ringing	Ringling Options	618
Do Not Disturb	Do Not Disturb	311
Drop	Conference	158

E

Executive Barge-In	Barge-In	95
Extended Call Completion	Queued Call Console	565
Extended Station Status	Extension Status	317
Extension Auto Dial	Auto Dial	62
Extension Directory	Directories	263
Extension Pickup	Pickup	494
Extension Programming	Programming	557

Feature Name...	See...	Page #...
Extension Status	Extension Status	317
	Group Calling	350

F

Facility Alpha/Number for Incoming Calls	Labeling	413
Facility Restriction Levels (FRLs)	Automatic Route Selection, Uniform Dial Plan (UDP) Features See also <i>Network Reference</i>	77 , 741
Fax Extension	Fax Extension	322
Fax Message Waiting	Messaging	429
Feature feedback	Display	271
Flexible Numbering	System Renumbering	685
Follow Me	Forward and Follow Me	326
Forced Account Code Entry	Account Code Entry/Forced Account Code Entry	30
Forward	Forward and Follow Me	326

G

General Pickup	Pickup	494
Group Assignment	Night Service	458
Group Call Pickup	Pickup	494
Group Calling	Group Calling, Extension Status	350 , 317
Group Coverage	Coverage	170
Group Paging (Speakerphone)	Paging	470
Group Pickup	Pickup	494

H

Hands-Free Answer on Intercom (HFAI)	Auto Answer Intercom	59
Hands-Free Unit	Auto Answer Intercom	59
Handset Mute	Headset Options	388
Headset Auto Answer	Headset Options	388
Headset Disconnect	Headset Options	388
Headset/Handset Mute	Headset Options	388
Headset Hang Up	Headset Options	388
Headset Operation	Headset Options	388
Headset Options	Headset Options	388

Feature Name...	See...	Page #...
Headset Status	Headset Options	388
	Queued Call Console	565
Hold	Hold	395
Hold Reminder Station	Display	271
Hold Return	Queued Call Console	565
Hotel mode	Extension Status	317
HotLine	HotLine	404
Hunt Groups	Group Calling	350
Hunt Type	Group Calling (page 350)	

I

ICOM buttons	System Access/Intercom Buttons	673
Identification of Stations Being Covered on Covering Party's Display	Display	271
Idle Line Preference	Automatic Line Selection and Ringing/Idle Line Preference	69
Immediate Ring	Ringing Options	618
Incoming Call Line Identification (ICLID)	Caller ID	125
Individual Coverage	Coverage	170
Individual Paging	Paging	470
Individual Pickup	Pickup	494
Inside Auto Dial	Auto Dial	62
Inside Dial Tone	Inside Dial Tone	409
Inspect	Inspect	410
Inspect Screen	Display	271
Intercom (ICOM) Buttons	System Access/Intercom Buttons	673
Intercom Dialing	System Access/Intercom Buttons	673
Intercom Dialing over Private Networks	Uniform Dial Plan (UDP) Features See also <i>Network Reference</i>	741
Intuity™	Appendix I	31
Intuity CONVERSANT	Appendix I	32
ISDN/BRI Interface	Basic Rate Interface. See also <i>Data/Video Reference.</i>	99
ISDN/PRI Interface	Primary Rate Interface (PRI) and T1 See also <i>Data/Video Reference</i>	509

Feature Name...	See...	Page #...
ISDN Terminal Adapter	Digital Data Calls	223
	Appendix I	41
	See also <i>Data/Video Reference</i>	

L

Labeling	Labeling	413
Last Number Dial	Last Number Dial	423
Last Number Redial	Last Number Dial	423
Leave Message	Messaging	429
Leave Word Calling	Messaging	429
Line Pickup	Pickup	494
Line Request	Line Request	427
Line/trunk Pool Button Access	Pools	500
Line/trunk Queuing	Callback	116
Loudspeaker Paging	Paging	470
LS-ID Delay Option	Caller ID	125

M

Maintenance Alarm	Alarm	37
Maintenance Busy	Automatic Maintenance Busy	75
Manual Signaling	Signal/Notify	645
Menu-Based Feature Activation	Display	271
Menu-Based Station Programming	Programming	557
MERLIN II System Display Console	Direct-Line Console	231
	Direct Station Selector	240
MERLIN LEGEND Mail	Appendix I	10
MERLIN LEGEND Reporter	Appendix I	23
Message (Fax)	Messaging	429
Message Center Operation	Queued Call Console	565
Message Indicator	Messaging	429
Message Status (Operator)	Messaging	429
Message Waiting Receiver	Group Calling	350
	Messaging	429
Messaging	Messaging	429
Microphone Disable	Microphone Disable	444
Missed Reminder	Reminder Service	598

Feature Name...	See...	Page #...
Modem Pooling	See <i>MERLIN LEGEND Communications System Modem Pooling</i> , Application Note	
Multi-Function Module	Multi-Function Module	446
Music-On-Hold	Music-On-Hold	454
Mute	Microphone Disable	444
Mute, Headset/Handset	Headset Options	388

N

N11 Table	Automatic Route Selection	77
Name/Number of Internal Caller	Display	271
Networked Systems	Uniform Dial Plan (UDP) Features See also <i>Network Reference</i>	741
Next Message	Messaging	429
Night Service	Night Service	458
No Ring Option	Ringing Options	618
Notify	Signal/Notify	645
Numbering Plan	System Renumbering	685

O

On- or Off-Hook Queuing	Callback	116
One-Touch Hold	Transfer	723
One-Touch Transfer	Transfer	723
Operator Automatic Hold	Hold	395
Operator Hold Timer	Hold	395
Originate Only	System Access/Intercom Buttons	673
Outside Auto Dial	Auto Dial	62
Outward Restriction	Calling Restrictions Night Service	132 458

P

Page All	Paging	470
Paging	Paging	470
Park	Park	479
PassageWay® Direct Connection Solution	Appendix I	5
PassageWay Telephony Services	CTI Link See also <i>PassageWay Telephony Services Network Manager's Guide</i>	208

Feature Name...	See...	Page #...
Patterns	Automatic Route Selection	77
Personal Directory	Directories	263
Personal Speed Dial	Speed Dial	648
Personalized Ring	Ringing Options	618
Pickup	Pickup	494
Pickup, Call Waiting	Call Waiting	110
Pool Dial-Out Code Restriction	Calling Restrictions	132
Pool Routing	Automatic Route Selection	77
Pool Routing: Private Network Trunks	Uniform Dial Plan (UDP) Features	741
Pools	Pools	500
Position Busy Backup	Queued Call Console	565
Posted Messages	Messaging	429
PRI	Primary Rate Interface (PRI) and T1 See also <i>Data/Video Reference</i>	509
Primary Coverage	Coverage	170
Primary Rate Interface (PRI)	Primary Rate Interface (PRI) and T1 See also <i>Data/Video Reference</i>	509
Prime Line	Centrex Operation	145
Principal User	Personal Lines System Access/Intercom Buttons	484 673
Printer	Station Message Detail Recording (SMDR)	655
Priority Call Ringing	Ringing Options	618
Privacy	Privacy	553
Programming	Programming	557

Q

Queue Priority	Queued Call Console	565
Queued Call Console (QCC)	Queued Call Console	565

R

Recall	Recall/Timed Flash	590
Reminder Service	Reminder Service	598
Remote Access	Remote Access	602
Remote Administration	See <i>System Programming</i>	
Remote Call Forwarding	Forward and Follow Me	326
Remote Programming	See <i>System Programming</i>	

Feature Name...	See...	Page #...
Restrictions	Calling Restrictions	132
Retrieve Message	Messaging	429
Return Call	Messaging	429
Return Ring Interval	Queued Call Console	565
Ring Buttons	System Access/Intercom Buttons	673
Ring Timing Options	Ringing Options	618
Ringback (Transfer Audible)	Transfer	723
Ringing/Idle Line Preference	Automatic Line Selection and Ringing/Idle Line Preference	69
Ringing Options	Ringing Options	618
Rotary Signaling	Touch-Tone or Rotary Signaling	716
Routes per Pattern	Automatic Route Selection	77
Routing by Dial Plan	Primary Rate Interface (PRI) and T1	509

S

SA Buttons	System Access/Intercom Buttons	673
Saved Number Dial	Saved Number Dial	626
Scroll	Messaging	429
Second Dial Tone Timer	Second Dial Tone Timer	630
Selective Callback	Callback	116
Secondary Coverage	Coverage	170
Send All Calls	Do Not Disturb	311
Send/Remove Message	Messaging	429
Send Ring	Ringing Options	618
Service Observing	Service Observing	632
Set Up Space	System Renumbering	685
Shared System Access	System Access/Intercom Buttons	673
Signaling	Signal/Notify	645
Six-Digit Screening	Automatic Route Selection	77
SMDR	Station Message Detail Recording (SMDR)	655
Speakerphone Paging	Paging	470
Special Numbers Pattern	Automatic Route Selection	77
Special Services Selection Table	Primary Rate Interface (PRI) and T1	509
Speed Dial	Auto Dial	62
	Directories	263
	Speed Dial	648

Feature Name...	See...	Page #...
SPM	Programming See also <i>System Programming</i>	557
Station Conference—External Parties	Conference	158
Station Conference—Total Parties	Conference	158
Station DSS Auto Dial	Direct Station Selector	240
Station Lines	System Access/Intercom Buttons	673
Station Message Detail Recording	Station Message Detail Recording (SMDR)	655
Station Programming	Programming	557
Station-to-Station Messaging	Messaging Signal/Notify	429 645
Supplemental Alert Adapter	Multi-Function Module	446
Switched 56	Primary Rate Interface (PRI) and T1 See also <i>Data/Video Reference</i>	509
Switchhook (Flash)	Recall/Timed Flash	590
Switched Loop Console	Queued Call Console	565
Switch Identifiers for Non-Local Networked Systems	Tandem Switching See also <i>Network Reference</i>	699
System Access Buttons	System Access/Intercom Buttons	673
System Directory	Directories	263
System Numbering, Non-Local Extensions	Uniform Dial Plan (UDP) Features	741
System Renumbering	System Renumbering	685
System Programming	Programming See also <i>System Programming</i>	557
System Speed Dial	Speed Dial	648
System Programming and Maintenance	Programming See also <i>System Programming</i>	557

T

T1 Interface (DS1)	Primary Rate Interface (PRI) and T1 See also <i>Data/Video Reference</i>	509
Tandem Switching	Tandem Switching	699
Three-Digit Numbering	System Renumbering	685
Time-Day-Date (Display)	Display	271
Timed Flash	Recall/Timed Flash	590
Time of Day Routing	Automatic Route Selection	77
Timer	Timer	712
Toll Restriction	Calling Restrictions	132

Feature Name...	See...	Page #...
Toll Type	Toll Type	714
Touch-Tone Receivers (TTRs)	Touch-Tone or Rotary Signaling	716
Touch-Tone Signaling	Touch-Tone or Rotary Signaling	716
Transfer	Transfer	723
Transfer Audible	Transfer	723
Transfer Return Identification	Display	271
Transfer Return Interval	Transfer	723
Trunk Pools	Pools	500
Trunk-to-Trunk Transfer	Transfer	723
TTRs	Touch-Tone or Rotary Signaling	716
Two-Digit Numbering	System Renumbering	685

U

UDC/DDC	Group Calling	350
UDP Features	Uniform Dial Plan (UDP) Features	741
Unrestricted Restriction	Calling Restrictions	132

V

Videoconferencing	Digital Data Calls	223
	Appendix I	34
	See also <i>Data/Video Reference</i>	
Voice Messaging Interface (VMI) Ports	Group Calling	350
Voice Announce	Paging	470
Voice Announce Disable	Voice Announce	757
Voice Announce Inside Calls	Paging	470
	System Access/Intercom Buttons	673
Voice Announce on Busy Stations	Voice Announce	757
Voice-Announced Transfer	Transfer	723
Voice Buttons	System Access/Intercom Buttons	673
Voice Mail Message Waiting	Messaging	429
Voice Mail Systems	Appendix I	6
Voice Messaging Systems	Appendix I	6

Index of Features by Activity

The tables in this section index system features according to the activities that people typically perform. Operator features are not covered exhaustively here because they are described in detail in the entries: [“Direct-Line Console” on page 231](#), [“Direct Station Selector” on page 240](#), and [“Queued Call Console \(QCC\)” on page 565](#). This index lists features according to the following categories:

- Basic Calling and Answering Features
 - Answering calls
 - Conferencing and joining calls
 - Dialing
 - Paging
 - Putting a call on hold
 - Using the system from an outside telephone
- Call Coverage Features
 - Covering calls
 - Having your calls covered
- Timekeeping Features
- Calling Privileges and Restrictions Features
 - Preventing people from making calls
 - Allowing calls
 - Other calling privileges
- Messaging Features
 - Leaving messages
 - Receiving messages
 - Controlling messaging
- System Manager Features
 - Customizing your system
 - Managing directories
 - Monitoring messages
 - Obtaining reports
 - Allocating lines and trunks
 - Assisting operators
 - Troubleshooting
- Telephone Customizing Features

Basic Calling and Answering Features

Activity...	For...	Feature Name...	Page #...
<i>Answering calls:</i>			
And seeing who is calling you from another extension	Display telephones	Display	271
And seeing who is calling you from an extension on a remote networked system (Hybrid/PBX mode)	MLX display telephones Release 6.0 and later	Display	271
And seeing who is calling you from outside	MLX display telephones	Display, Caller ID Primary Rate Interface	271 125 509
And identifying the type of call according to the ring	All	Ringing Options	618
And transferring to another extension	All	Transfer	723
And transferring to an outside number	All except single-line	Transfer	723
And transferring to a non-local extension (Hybrid/PBX mode)	All	Uniform Dial Plan (UDP) Features	741
At another extension	All	Pickup	494
At a line not on your telephone	All	Pickup	494
At a line you share with others	All	System Access/ Intercom Buttons Personal Lines Centrex Operation	673 484 145
For another person or group of people	All	Coverage Personal Lines System Access/ Intercom Buttons Forward/Follow Me Queued Call Console Direct-Line Console Group Calling	170 484 673 326 565 231 350
If you are a calling supervisor for people answering calls	DLC and QCC operators only	Direct-Line Console Queued Call Console Direct Station Selector Group Calling Extension Status	231 565 240 350 317

Basic Calling and Answering Features — *Continued*

Activity...	For...	Feature Name...	Page #...
If you are an operator	DLC and QCC operators only	Direct-Line Console Queued Call Console Direct Station Selector	231 565 240
If you are part of a group	All	Group Calling, Extension Status	350 317
Waiting for you, after you hear call-waiting tone	All	Call Waiting	110
That come to your extension while you are at another extension	All	Forward/Follow Me	326
And then disconnect, without using the handset or Speaker button	All	Recall/Timed Flash	590
Using a Hands-Free Unit, without lifting the handset	Analog multiline with no speaker	Auto Answer Intercom	59
Using a headset	MLX	Headset Options	388
Using a modem, fax machine, or headset	Analog multiline	Auto Answer All	56
<i>Conferencing and joining calls:</i>			
Conferencing inside and outside parties where the inside parties do not share a line	All	Conference	158
Joining calls of inside parties who share a line	All	System Access/ Intercom Buttons Personal Lines Centrex Operation	673 484 145
Preventing others from joining your calls	All except QCC	Privacy	553
Joining a caller and the extension he or she wants to reach	All except operators	Transfer	723
<i>Dialing:</i>			
An inside call	All	System Access/ Intercom Buttons Centrex Operation	673 145
An inside call to an extension on a networked system (Hybrid/PBX mode)	All, Release 6.0 and later systems	Uniform Dial Plan (UDP) Features	741

Basic Calling and Answering Features — *Continued*

Activity...	For...	Feature Name...	Page #...
An outside call	All	System Access/ Intercom Buttons Pools Personal Lines Centrex Operation	673 500 484 145
An inside or outside number with one touch	All except single-line and QCC	Auto Dial	62
An inside or outside number with one touch	Operators with MLX telephones or System Display Consoles only	Direct Station Selector	240
An inside or outside number by lifting the handset of a single-line telephone	Single-line only (Release 5.0 and later systems)	HotLine	404
A call from another extension, using your own calling privileges	All	Authorization Code	49
An inside call to anyone in a group of people	All	Group Calling	350
An Account Code, for billing to a project or client, during or before a call	All	Account Code Entry/ Forced Account Code Entry	30
By entering a 3-digit code for a party that people in your company call often	All	Speed Dial	648
By entering a 2-digit code for a party you call often (telephones with 10 or fewer buttons)	All	Speed Dial	648
By selecting a name from the display	All	Directories	263
A person who has left a message on your display, with one touch	Display telephones only	Messaging	429
Outside of normal office hours	All	Night Service	458
A number you dialed before	All except QCC	Last Number Dial Saved Number Dial	423 626
A busy extension to reach it when it is available	All except QCC	Callback Camp-On	116 140

Basic Calling and Answering Features — *Continued*

Activity...	For...	Feature Name...	Page #...
A busy line to have your call placed when the line is available	All except QCC (and single-line and cordless or wireless, for Line Request)	Callback Line Request	116 427
When you want to interrupt a call at a busy extension or one with Do Not Disturb on	Operators only	Barge-In	95
Using a special long-distance service to which your company subscribes, such as MEGACOM® WATS	System managers (to set up)	Primary Rate Interface Pools Automatic Route Selection	509 500 77
Using a line/trunk that originates at another system in your private network	System managers (to set up); Release 6.0 and later	Tandem Switching Automatic Route Selection	699 77
A voice mail box	All	Direct Voice Mail	260
Change the Extension Directory to accommodate new or changed extensions	System managers only	Labeling	413
Change the System Directory to accommodate business needs	System managers only	Labeling	413
Paging:			
One person at your company who has a speakerphone and is not a QCC operator or at a single-line telephone	All	System Access/ Intercom Buttons	673
Several people at your company who have speakerphones and are not QCC operators or at single-line telephones	All	Paging Pickup	470 494
All the people at your company who have speakerphones and are not QCC operators or at single-line telephones	All	Paging Pickup	470 494
Over your company's loudspeaker system	All	Paging Pickup	470 494
Prevent or allow voice-announced calls from coming in over your speakerphone	Analog multiline and MLX	Voice Announce	757

Basic Calling and Answering Features — *Continued*

Activity...	For...	Feature Name...	Page #...
<i>Putting a call on hold:</i>			
At your own extension, so that you can pick it up	All except single-line	Hold	395
At your own extension, so that you can pick it up	Single-line	Recall/Timed Flash	590
At your own extension, so that you or someone who shares a line can pick it up	All	Hold System Access/ Intercom Buttons Personal Lines Centrex Operation	395 673 484 145
At your own extension, automatically in order to transfer an outside call to another extension with a shared line or button	All	Transfer	723
At your own extension, so that anyone can pick it up after you page them	All except QCC	Park	479
At one of several reserved extensions, so that anyone can pick it up after you page them	Operators only	Park	479
Automatically	DLC operators only	Hold Direct-Line Console	395 231
<i>Using the system from an outside telephone:</i>			
To gain access to the system as if you were on an inside extension	N/A	Remote Access	602
To receive calls that come to your system extension	N/A	Forward/Follow Me	326

Call Coverage Features

Activity...	For...	Feature Name...	Page #...
<i>Covering calls:</i>			
As an operator	DLC and QCC operators only	Direct-Line Console Queued Call Console Direct Station Selector	231 565 240
As a calling supervisor for people covering calls	DLC and QCC operators only	Direct-Line Console Queued Call Console Direct Station Selector Group Calling Extension Status	231 565 240 350 317
As a member of a group	All	Group Calling Coverage	350 170
And you want to adjust the ringing at the button where calls come in	All except single-line	Coverage Ringing Options	170 618
<i>Having your calls covered:</i>			
By someone who shares a line	All	System Access/ Intercom Buttons	673
Occasionally	All	Forward/Follow Me	326
Occasionally, and you wish to change forwarding options from any multiline telephone in the system	All; Release 6.0 and later systems	Forward/Follow Me Authorization Code	326 49
By voice mail	All	Coverage	170
Regularly	All	Coverage	170
And you want to adjust or remove the ringing at the button(s) where covered calls arrive	All except single-line	Coverage Ringing Options	170 618
At an outside number (for example, your home office)	All	Forward/Follow Me	326
At a number outside the MERLIN LEGEND Communications System, for calls arriving on Centrex lines	All; Release 6.0 and later systems	Forward/Follow Me	326

Timekeeping Features

Activity...	For...	Feature Name...	Page #...
To set others' telephones to ring at a certain time as a reminder	DLC operators only	Reminder Service	598
To set your own telephone to ring at a certain time as a reminder	All	Reminder Service	598
To set the alarm clock on your telephone	Display telephones only	Alarm Clock	40
To set the time at your telephone	Display telephones only	Alarm Clock	40
To set the timer for calls or other activities	Display telephones only	Alarm Clock	40
To set the systemwide time	System manager only	See <i>System Programming</i>	

Calling Privileges and Restrictions Features

Activity...	For...	Feature Name...	Page #...
<i>Preventing people from making calls:</i>			
To your extension	All except operator	Privacy Do Not Disturb	553 311
To your extension when your telephone is too busy to take any more calls or you must be away from your telephone	QCC only	Queued Call Console	565
To outside numbers	System manager only	Calling Restrictions Toll Type	132 714
To toll numbers	System manager only	Calling Restrictions Automatic Route Selection Pools Toll Type	132 77 500 714
To certain numbers or area codes	System manager only	Allowed/Disallowed Lists	42
Outside of normal business hours	System manager only	Night Service	458

Calling Privileges and Restrictions Features — *Continued*

Activity...	For...	Feature Name...	Page #...
On certain outside lines in a Hybrid/PBX system	System manager only	Automatic Route Selection	77
		Pools	500
		Toll Type	714

Allowing calls:

To certain numbers or area codes	System manager only	Allowed/Disallowed Lists	42
		Speed Dial (System Speed Dial)	648
Outside of normal business hours	System manager only	Night Service	458

Other calling privileges:

To use your own calling privileges at others' extensions	All	Authorization Code	49
To enter your password for off-hours calls	All	Night Service	458

Messaging

Activity...	For...	Feature Name...	Page #...
Leaving messages:			
Turn an extension's Message light on or off to indicate that you have a message for the party	Operators only	Messaging (Send/Remove Message)	429
Call and let a co-worker with a display telephone know that you have called	All	Messaging (Leave Message)	429
Let a co-worker with a display telephone know that you wish to speak with him or her, without calling	All except QCC	Messaging (Leave Message)	429
		Signal/Notify	645
Let a co-worker with a multiline telephone know that you wish to speak with him or her, without calling	All except QCC	Signal/Notify	645
Post a specific message (such as, OUT TO LUNCH) for co-workers who have display telephones	All except single-line	Messaging (Posted Messages)	429

Messaging — *Continued*

Activity...	For...	Feature Name...	Page #...
Cancel a message left for a co-worker who has a display telephone	All	Messaging (Leave Message)	429

Receiving messages:

Read messages	Display telephones only	Messaging	429
Turn off Message light	All	Messaging	429
Delete messages	Display telephones only	Messaging	429
Return a call from a co-worker who has left a message	Display telephones only	Messaging	429

Controlling messaging:

Change the posted messages that users can choose from	System manager only	Labeling	413
Change the extension information that appears on display telephones that have messages	System manager only	Labeling	413
Set up voice messaging system to take calls	System manager only	Group Calling	350
Set up extensions to receive messages from a fax machine that has a delivery for them	System manager only	Messaging	429
Set up calling groups to receive messages from co-workers	System manager only	Messaging	429

System Manager Features

Activity...	For...	Feature Name...	Page #...
Customizing your system:			
Set up account codes so that calls can be billed or tracked to a specific client or project	N/A	Account Code Entry/ Forced Account Code Entry	30

System Manager Features — *Continued*

Activity...	For...	Feature Name...	Page #...
Set up which line is selected when a user lifts the handset or presses the Speaker button	All telephones	Automatic Line Selection and Ringing/Idle Line Preference	69
Change extension numbers for extensions, adjuncts, lines, telephones, ranges of extensions on a DSS, ARS, calling groups, Idle Line Access, Listed Directory Number (LDN), paging groups, park zones, Pools, or Remote Access	All	System Renumbering	685
Add or change ranges of non-local dial plan extension numbers so that local users can dial them as if they were connected to the local system	All, Release 6.0 and later systems	Uniform Dial Plan (UDP) Features	741
Change the overall system numbering plan; for example, change to 2-, 3-, or a variable number of digits for extension numbers	All	System Renumbering	685
Modify the line buttons (SA or ICOM) available on a user's telephone: change, add, or delete	All except single-line	System Access/ Intercom Buttons	673
Set up a single-line telephone so that it dials a specific inside extension or outside number as soon as someone lifts the handset	For single-line only (Release 5.0 and later)	HotLine Speed Dial	404 648
Adjust the ringing at an extension, including one with a single-line telephone or Multi-Function Module (MFM)	For single-line/ MFM	Ringing Options, Coverage	618 , 170
Set up special telephones to be used for incoming and outgoing calls during a commercial power failure	N/A	Power-Failure Transfer	507
Adjust the system dial tone to accommodate a voice messaging system or modem	N/A	Inside Dial Tone	409
Control what a caller hears while waiting for the system (during transfer, while on hold, or during other operations where the caller must wait)	N/A	Music-On-Hold	454
Set up an adapter connected to an MLX extension to support a fax machine, modem, or other device	N/A	Multi-Function Module	446

System Manager Features — *Continued*

Activity...	For...	Feature Name...	Page #...
Change the language (English, French, or Spanish) used in System Programming and Maintenance (SPM) software	System manager or programmer	Labeling	413
Change the language (English, French, or Spanish) used in Station Message Detail Recording (SMDR) and programming reports	N/A	Labeling	413
Change the language used (English, French, or Spanish) systemwide or at an extension; this also changes the clock, which is 12-hour for English and 24-hour for French or Spanish	MLX display telephones only	Language Choice	418
In Hybrid/PBX mode, change the display of caller information for non-local dial plan calls	MLX display telephones, Release 6.0 and later	Uniform Dial Plan (UDP) Features	741
Set up the Transfer feature for one-touch Transfer or automatic Hold	All	Transfer	723
Control extensions with software running on an associated worktop PC, on a local area network (LAN) running Novell NetWare [®] 3.12, 4.1, or 4.11	MLX and analog multiline	CTI Link	208

Directories:

Change a user's Personal Directory listings	MLX display telephones only	Labeling	413
Change the Extension Directory to accommodate new or changed extensions	N/A	Labeling	413
Change the names listed with System Directory entries to accommodate business needs	N/A	Labeling	413

Monitoring Messages:

Change the posted messages that users can choose from	N/A	Labeling	413
Change the extension information that appears on display telephones with inside calls and messages	N/A	Labeling	413

System Manager Features — *Continued*

Activity...	For...	Feature Name...	Page #...
Set up a group of fax machines to take calls	N/A	Group Calling	350
Set up voice messaging system to take calls	N/A	Group Calling	350
<i>Obtaining reports:</i>			
Obtain a report on incoming and outgoing calls, including account codes, if programmed	N/A	Station Message Detail Recording	655
Get a report on the way the system is programmed	N/A	Station Message Detail Recording	655
<i>Allocating lines and trunks:</i>			
In Hybrid/PBX mode, route calls for maximal cost savings, security, and efficiency	All	ARS	77
In Hybrid/PBX mode, allow non-local users to access PSTN trunks connected to your local system, to save toll costs	All; Release 6.0 and later	Tandem Switching Remote Access	699 602
In Hybrid/PBX mode, allow local users to access PSTN trunks connected to another system in your network, to save toll costs	All; Release 6.0 and later	Tandem Switching ARS	699 77
Take an outside line out of service when there is a problem with it	N/A	Automatic Maintenance Busy	75
In Hybrid/PBX mode, assign lines that can be answered without operator involvement	All telephones	Personal Lines	484
In Behind Switch mode, allow Conference, Transfer, and Drop buttons to access host features	N/A	Recall/Timed Flash	590
<i>Assisting Operators:</i>			
Allow a QCC operator to join callers and extensions more rapidly	N/A	Queued Call Console	565
Find out about the Alarm button on operator consoles or set up a special light or bell to signal a system problem	Operator consoles	Alarm	37
<i>Troubleshooting:</i>			
Prevent DLC operators from accidentally disconnecting callers	N/A	Hold Direct-Line Console	395 231

System Manager Features — Continued

Activity...	For...	Feature Name...	Page #...
Find out what to do when callers on hold are being disconnected	N/A	Hold	395
Make your system more secure from toll fraud	N/A	Calling Restrictions Remote Access Forward/Follow Me ARS Group Calling	132 602 326 77 350
Correct problems that users are having with the switchhook, Recall, or Flash button	N/A	Recall/Timed Flash	590
Join a caller and the extension he or she wants to reach	Operator consoles	Direct-Line Console Queued Call Console	231 565
Find out about the Alarm button that signals a system problem	Operator consoles	Alarm	37
Find out about the Alarm button that signals too many calls waiting in line for your attention or your group's attention	Operator consoles	Group Calling, Auto Dial	350 62
Activate Night Service for system use outside of normal business hours	Operator consoles	Night Service	458
Set up the way calls are distributed to calling group members	System manager only	Group Calling	350
Monitor others' calls	N/A	Direct-Line Console Queued Call Console Direct Station Selector, Extension Status Group Calling	231 565 240 317 350
Set up a device to answer calls when a group is unavailable to take them	System manager only	Group Calling	350
Log a calling group member in or out.	Operator consoles	Group Calling, Extension Status X	350 317
Control the number of calls that can be waiting in a calling group queue before callers receive a busy signal	System manager only, Release 6.0 and later	Group Calling	350
Set options that control when calling group calls are sent to a QCC operator or calling group for overflow handling and when a calling group alarm or alert is activated to indicate that too many calls are in queue	System manager only	Group Calling	350

System Manager Features — Continued

Activity...	For...	Feature Name...	Page #...
Log a delay announcement device for a group in or out	Operator consoles	Group Calling	350
Allow DLC operators to place calls on hold automatically	System manager only	Hold Direct-Line Console	395 231
Turn an extension's Message light on or off to indicate that you have a message for the party	Operators only	Messaging (Send/Remove Message)	429

Customizing Your Telephone

Activity...	For...	Feature Name...	Page #...
Using the line buttons on your telephone	All	System Access/ Intercom Buttons Personal Lines Pools Centrex Operation	673 484 500 145
Programming buttons	Multiline telephones	Programming	557
Changing the ringing sound on your telephone	All	Ringing Options	618
Changing the number of times calls ring	All	Ringing Options	618
Using the display to screen incoming calls	MLX display telephones only	Inspect	410
Seeing what features are programmed on telephone buttons	MLX display telephones only	Inspect	410
For noisy environments: turning off the microphone at an MLX telephone (except a QCC) so that a user can hear voice announcements but must lift the handset to respond	System manager only	Microphone Disable	444

Features

Abbreviated Ring

29

Abbreviated Ring

See [“Ringling Options” on page 618.](#)

Account Code Entry/Forced Account Code Entry

At a Glance

Users Affected	Telephone users, operators, data users
Reports Affected	Extension Directory, Extension Information, SMDR
Modes	All
Telephones	All touch-tone telephones
Programming Code	*82
Feature Code	82
MLX Display Label	Account Code [Acct]
System Programming	Enter extensions required to use account codes before making an outside call: <ul style="list-style-type: none"> ■ Extensions→Account
Hardware	Printer for SMDR Reports, or PC and printer equipped with Lucent Technologies CAS software needed for Account Code Reports
Maximum	16 characters (0–9, *)
Factory Setting	Forced Account Code not assigned to any extensions

Description

Use Account Code Entry to enter account codes (developed by accounting or administrative personnel) for outside calls, both incoming and outgoing. These codes appear on Station Message Detail Recording (SMDR) reports, along with other call information, and are used for billing or cost-accounting to identify outgoing calls with a project, client, or department. You can enter an account code before or during a call or not at all. You can also change, correct, or cancel an account code while the call is in progress.

Forced Account Code Entry is similar, but it affects only outgoing calls and requires a caller to enter an account code before placing an outside call. You can change or correct an account code while a call is in progress, but you cannot cancel it.

To enter, change, or correct an account code during a call, activate the feature and enter the account code. Only the person who enters the account code hears

the tones generated by dialing the account code number. To cancel an account code (when permitted), activate the feature and exit without entering a code.

Forced Account Code Entry, when activated for an extension, has the following effects:

- If you select an outside line on an SA button (by dialing a dial-out code) or on an ICOM button (by dialing the Idle Line Access code) without entering an account code, the call is blocked. Depending on the type of telephone used, this may be indicated by the programmed Account Code Entry button flashing, the SA button going to the off/idle state, or an intercept tone.
- If you try to make an outside call on a personal line or Pool button without entering an account code, there is no dial tone.

Considerations and Constraints

If SMDR is set to record outgoing calls only, you cannot enter an account code for incoming calls.

The system does not validate account codes; it checks only the number of characters entered (maximum of 16) and completion (signaled by dialing # or pressing a programmed Account Code Entry button).

Account codes can be no more than 16 characters in length, and only the digits 0–9 and the character * can be used.

Forced Account Code Entry allows you to enter account codes for incoming calls, including incoming calls added to a conference call, by using the Account Code Entry feature. Account codes are not mandatory in these situations. (Outgoing, outside calls added to a conference must have an account code.)

You cannot change an account code entered from another extension.

An incoming caller cannot hear tones as account codes are entered during a call.

An Account Code Entry button only activates and completes the account code entry. It does not automatically enter an account code. A separate outside Auto Dial button can be programmed with an account code number.

In Release 2.0 and prior systems, a user at an extension programmed with Forced Account Code Entry must enter an account code to use Loudspeaker Paging. In Release 2.1 and later systems, users at extensions programmed with Forced Account Code Entry do not need to enter an account code to use Loudspeaker Paging.

Mode Differences

Behind Switch Mode

In Behind Switch mode, single-line telephones must be programmed through Idle Line Preference to select an SA or ICOM button when the user lifts the handset to make an outgoing call.

Telephone Differences

Queued Call Consoles

To make an outgoing call from a Queued Call Console (QCC), activate Account Code Entry by selecting the feature from the Home screen, or by pressing the Feature button and selecting the Account Code Entry feature from the display. After the account code is dialed, complete the entry by dialing #. Then select a personal line, SA, or Pool button on which to make the call.

Normally, you cannot enter account codes when you answer a Group Coverage call at a Group Cover button programmed on a multiline telephone. When the QCC queue is programmed as the receiver for a coverage group, however, Cover buttons are not required and the QCC system operator can enter account codes. Those account codes appear on the SMDR printout. In this case, the Account Code Entry feature must be activated from the display and cannot be activated by dialing the feature code.

MLX Telephones

You can program account codes individually on outside Auto Dial buttons. You can also program an account code as an entry in the Personal Directory (MLX-20L[®] telephones). Enter an account code by pressing the Feature button and selecting *Account Code* from the display.



NOTE:

Account codes cannot be entered with System Speed Dial or Personal Speed Dial because pressing # to activate speed dial completes account code entry.

On MLX display telephones, you can also activate and complete the feature by pressing the Feature button and selecting the feature from the display. Once the entry is complete, select a personal line, SA, or Pool button, lift the handset, and make the call.

If Account Code Entry is assigned to a button, the LED flashes when you lift the handset and attempt an outside call. On MLX display telephones, the feature name appears on the display. Enter the account code and press the programmed Account Code Entry button; the green LED goes from flashing to on. Then select the outside line and proceed with the call.

ETR, MLS, and Analog Multiline Telephones

You can program account codes individually on outside Auto Dial buttons on ETR, MLS, and analog multiline telephones. Activate Account Code Entry by pressing a programmed Account Code Entry button, or by pressing the Feature button and dialing 82. After dialing the account code, complete the entry by pressing a programmed Account Code Entry button or dialing #.

If Account Code Entry is assigned to a button, the LED flashes when you lift the handset and attempt an outside call. Enter the account code and press the programmed Account Code Entry button; the green LED goes from flashing to on. Then select the outside line and proceed with the call.

Single-Line Telephones

By default, single-line telephones in Behind Switch mode cannot use Account Code Entry or Forced Account Code Entry. If this feature is to be used, the single-line telephone must be programmed through Idle Line Preference to select an SA or ICOM button so that you hear an inside dial tone when the handset is lifted for an outgoing call.

Single-line telephones must have touch-tone dialing to use the Account Code Entry feature. When a single-line telephone user hears inside dial tone, you can activate the feature by dialing #82.

On a single-line telephone, you cannot enter account codes by using System Speed Dial or Personal Speed Dial, because these features are activated by dialing #. Pressing # completes the entry of an account code and cannot also be used to activate the Speed Dial features.

Feature Interactions

- Authorization Code** If you do not enter an account code, the ACCOUNT field of the SMDR printout contains the authorization code or the home extension used to obtain restriction privileges. If you enter an account code at any time during a call, that account code is stored in the SMDR record.
- If the extension used to make a call is assigned Forced Account Code Entry, the caller is not forced to enter the account code while using the Authorization Code feature.
- If the home extension is assigned Forced Account Code Entry, you must enter an account code before entering an authorization code.
- Auto Dial** You can program often-used account codes on outside Auto Dial buttons.
- Automatic Line Selection** On a single-line telephone, you can enter account codes only if Automatic Line Selection is programmed to select an SA or ICOM button when the handset is lifted.
- Automatic Route Selection** When ARS is used, enter an account code before or after dialing the telephone number. If Forced Account Code Entry is assigned, enter the code before dialing the ARS dial-out code.
- Callback** You should enter an account code before activating Callback; otherwise, you cannot enter the account code until after the call connects. You cannot enter account codes while the call is queued.
- You must enter a forced account code before Callback is activated. If not, you hear a busy tone.
- Conference** You should enter a separate account code for each added outside conferee.
- Coverage** When answering calls on a programmed Cover button, a receiver cannot enter an account code. An account code must be entered from the sender's telephone. If the receiver tries to enter an account code, no error tone sounds, but the account code does not appear on the SMDR report. Cover buttons are not required when a QCC queue is programmed as a receiver for a coverage group; therefore, a QCC operator can enter account codes, which appear on the SMDR report.
- Digital Data Calls** Account codes can be entered for calls made by digital data workstations and by video systems that support the use of # for feature codes. The account code must be entered before the telephone number.
- Directories** On an MLX-20L telephone, you can program an account code as a listing in a Personal Directory. To enter the code from the display, activate Account Code Entry and choose the directory entry with the code.

Display	When you activate an Account Code Entry feature, the ACCT : message on the display prompts you to enter the account code. The account code digits appear next to the prompt as they are dialed.
Forward and Follow Me	<p>You cannot enter account codes for calls forwarded to outside numbers. Account codes are not necessary for calls forwarded to extensions.</p> <p>On telephones with Forced Account Code Entry assigned, you can forward calls only to local extensions and not to outside telephone numbers. If the extension has Remote Call Forwarding on with an outside number programmed and Forced Account Code Entry is activated, then Remote Call Forwarding is overridden and calls ring only at the extension.</p>
HotLine	HotLine extensions (Release 5.0 and later) cannot use account codes.
Personal Lines	When Forced Account Code Entry is assigned to an extension and you try to dial an outside call on a personal line button without entering the account code, the call does not go through.
Pools	When Forced Account Code Entry is assigned to an extension and you try to dial an outside call on a Pool button without entering the account code, the call does not go through.
Primary Rate Interface and T1	At an extension assigned to a PRI line, you can enter an account code either before the call is made or during the call. Forced account codes must be entered before calling. If you enter an account code before a call is dialed, it is treated as a restriction code for <i>all</i> the outgoing calls placed over the PRI line.
Remote Access	A remote access user cannot enter account codes. If a remote access user, however, calls an inside extension and the person at that extension enters an account code, the code overwrites the barrier code number (01–16) in the ACCOUNT field of the SMDR report.
SMDR	The account code appears in the ACCOUNT field of the SMDR record. If SMDR is programmed for outgoing calls only, you cannot enter an account code for an incoming call. If a remote access barrier code is entered for an incoming call and then an account code is entered, only the account code (not the barrier code ID) appears on the report.
Speed Dial	You can program a System Speed Dial number or a Personal Speed Dial number to replace a long account number, but you cannot program it to contain both an account number and a telephone number. Single-line telephones cannot use Personal Speed Dial or System Speed Dial to dial account codes because the # required to use Speed Dial is also used to terminate Account Code Entry.

Features

Account Code Entry/Forced Account Code Entry

36

Transfer

When a call is transferred, the destination extension cannot change an account code entered at the originating extension.

UDP Features

In Release 6.0 and later systems (Hybrid/PBX mode only), account codes entered on the local system are reported by SMDR. Account codes can be entered for private network calls. When Forced Account Code Entry is programmed, you can still dial a non-local extension without entering an account code.

Alarm

At a Glance

Users Affected	Operators
Reports Affected	Extension Information
Mode	All
Telephones	System operator consoles only (QCC or DLC)
Programming Code	*759
MLX Display Label	Alarm [Alarm]
System Programming	AuxEquip→MaintAlarms
Hardware	Alert device (bell or strobe) for Maintenance Alert

Description

Alarms provide either a visible or audible indication when the system detects a problem that needs immediate attention.

- **Alarm Button.** A programmed button on Direct-Line Consoles (DLCs) and a factory-set button on QCCs that alerts an operator to system problems. The red LED next to the Alarm button on the operator console lights when the system detects a problem (such as a problem with one of the lines/trunks or some other system error) that requires immediate attention. It remains on until the problem is corrected.
- **Maintenance Alert.** An alert device such as a bell or strobe light connected to the line or trunk designated as a maintenance alarm jack. The device rings or lights when the system detects a problem.

The red LED on the processor module turns on when the system detects a problem that requires immediate attention. It remains lit until the problem is corrected.

The red LED on some modules turns on when the system detects a module-related problem—for example, a loss of service on a 100D module.

Considerations and Constraints

As soon as the system detects a problem, the red LED next to the Alarm button turns on and/or the maintenance alert sounds or flashes.

All system operator consoles with an Alarm button receive the indication.

Telephone Differences

Alarm buttons can be programmed only on system operator consoles.

Direct-Line Consoles

The Alarm button is not a fixed feature and can be assigned to any available button on an analog or MLX DLC.

An Alarm button can be factory-assigned on an analog DLC but not on an MLX DLC. On a system with fewer than 29 lines, the Alarm button is factory-assigned to analog DLCs with 34 or more buttons. On a system with more than 29 lines, Line 30 is assigned to the button that would have been the Alarm button.

An operator at an MLX DLC can use the Inspect feature to display the number of alarms; an analog DLC operator cannot use Inspect.

Queued Call Consoles

An Alarm button is a fixed feature on a QCC.

A QCC operator can use the Inspect feature to display the number of alarms.

Feature Interactions

Automatic Maintenance Busy	When more than 50 percent of the lines/trunks in the pool are in a maintenance-busy state, the red LED next to the Alarm button on system operator consoles turns on, and the designated maintenance alert device sounds or flashes.
CTI Link	When a CTI link is reset (called a <i>broadcast reset</i>), any programmed Alarm buttons on operator consoles or connected alarm devices light up.
Direct-Line Console	<p>A DLC operator uses an Alarm button to monitor system operation. The red LED next to the Alarm button on the operator console goes on when the system detects a problem that requires immediate attention. An operator with an MLX DLC can use Inspect to display the number of alarms; an operator with an analog DLC cannot use Inspect. On a system with fewer than 29 lines, an Alarm button is factory-assigned to analog DLCs with 34 or more buttons.</p> <p>On a system with more than 29 lines, the Alarm button is replaced with the line 30 button. The Alarm button is not a fixed feature and can be assigned to any available button on an analog or MLX DLC.</p>
Inspect	You can use Inspect on an MLX DLC or a QCC to display the number of alarms.

Features
Alarm

39

Night Service A line/trunk jack programmed as a maintenance alarm port cannot be assigned to a Night Service group.

Personal Lines A line/trunk jack used for a maintenance alarm cannot be assigned as a personal line.

Pools A line/trunk jack used for a maintenance alarm cannot be assigned to a pool (Hybrid/PBX mode only).

UDP Features In Release 6.0 and later systems (Hybrid/PBX mode only), in private networks, system alarms must be on the local system. The Alarm button on an operator console responds to the local system.

Alarm Clock

At a Glance

Users Affected	Telephone users, operators
Reports Affected	None
Modes	All
Telephones	MLX display and analog multiline telephones
MLX Display Label	AlarmClk [Alarm]

Description

If you have a display telephone, you can use it as an alarm clock and set it to beep at a particular time to remind you of an appointment, meeting, or other important event. Until canceled, the alarm sounds every day at the set time.



NOTE:

The Alarm Clock feature is not supported on ETR and MLS telephones. For information about setting time reminders, see [“Reminder Service” on page 598](#).

Each MLX telephone and analog multiline display telephone has a timer to time calls, meetings, breaks, or other events. When activated, the timer appears at the top of the display, next to the date, and starts counting. It counts to 59 minutes and 59 seconds, then resets to zero and continues counting.

To Set the Alarm

To set the alarm on an MLX display telephone, follow the procedure below:

1. Press the Menu button.
2. Select Alarm Clock [AlClk]. If this feature is not displayed, press the More button. The display shows the alarm status (on/off) and the time set.
3. For English-language operation, dial a 4-digit time from 0100 to 1259 and select am/pm to switch the displayed time from A.M. to P.M. or back again. For French- or Spanish-language operation, dial a 4-digit time from 0000 to 2359. If you make an error, select Reset and redial.
4. Select On.
5. Press the Home button. A bell appears on the Home screen.

To set the alarm on an analog multiline telephone, follow the procedure below:

1. Press the Set button. *ALARM Off* begins to flash.
2. Press the Fwd button. *ALARM On* begins to flash.
3. Press Set. *Hour* and *am/pm* begin to flash.
4. Press Fwd or Rev until the setting you want appears on the display.
5. Press Set. *Minutes* begins to flash.
6. Press Fwd or Rev until the setting you want appears on the display.
7. Press the Exit button. A bell appears on the display next to the date.

To Cancel the Alarm

To cancel the alarm on an MLX display telephone, follow the procedure below:

1. Press the Menu button.
2. Select *Alarm Clock [ALClk]*. If this feature is not displayed, press the More button.
3. Select *Off*.
4. Press the Home button. The bell disappears from the Home screen.

To cancel the alarm on an analog multiline telephone, follow the procedure below:

1. Press the Set button. *ALARM On* begins to flash.
2. Press the Fwd button. *ALARM Off* begins to flash.
3. Press the Exit button. The bell disappears from the display.

Feature Interactions

Language Choice

Enter the time settings for Alarm Clock in accordance with the language selection governing the extension. If the language selection is English, the time setting for Alarm Clock must be entered in 12-hour format (0100–1259), followed by either a 2 (A) for a.m. or a 7 (P) for p.m. If the governing language selection is French or Spanish, the time setting must be entered in 24-hour format (0000–2359).

Allowed/Disallowed Lists

At a Glance

Users Affected	Telephone users, operators, data users
Reports Affected	Access to Allowed Lists, Access to Disallowed Lists, Allowed Lists, Disallowed Lists, Remote Access (DISA) Information
Modes	All
Telephones	All
System Programming	<p>Establish, change, or remove Allowed/Disallowed Lists:</p> <ul style="list-style-type: none"> ■ Tables→AllowList/Disallow <p>Assign or remove Allowed/Disallowed Lists for individual extensions:</p> <ul style="list-style-type: none"> ■ Tables→AllowTo/DisallowTo <p>Assign or remove Disallowed Lists for non-tie lines/trunks used for Remote Access:</p> <ul style="list-style-type: none"> ■ LinesTrunks→RemoteAccss→Non-TIE Lines→DisallowLst <p>Assign or remove Disallowed Lists for tie trunks used for Remote Access:</p> <ul style="list-style-type: none"> ■ LinesTrunks→RemoteAccss→TIE Lines→DisallowLst <p>Assign or remove Disallowed Lists for each remote access barrier code:</p> <ul style="list-style-type: none"> ■ LinesTrunks→RemoteAccss→Barrier Code→DisallowLst
<p>Maximums</p> <p>Allowed Lists</p>	<p>6 digits for each number (plus leading 1, if required)</p> <p>10 numbers for each list. Release 3.1 and later systems may also have an asterisk (*) preceding a leading star code.</p> <p>8 lists for each system</p> <p>8 lists for each extension</p>
Disallowed Lists	<p>11 digits for each number (plus wildcard)</p> <p>10 numbers for each list</p> <p>8 lists for each system</p> <p>8 lists for each extension</p>
<p>Factory Settings</p> <p>Second Dial Tone Timer</p>	<p>0 ms (range: 0–5,000 ms, increments of 200, entries rounded down if not increments of 200)</p>
<p>Default Disallowed List Entries Assigned to</p>	<p>Disallowed List 7</p> <p>0, 10, 11, 1809, 1700, 1900, 976, 1ppp976, * (p=any digit)</p> <p>All VMI ports</p>

Description

Used in conjunction with calling restrictions (outward and toll), an Allowed List identifies numbers that the caller is allowed to dial, despite restrictions. For example, an Allowed List assigned to an outward-restricted extension can allow calls to specific local numbers, such as 911 or toll numbers. For toll-restricted extensions, an assigned Allowed List can allow calls to specific area codes and/or exchanges needed for daily tasks.

A Disallowed List identifies local or toll numbers that the extension user is *not* allowed to dial, even if the extension is otherwise unrestricted. Disallowed Lists can be used as an alternative to, or in conjunction with, calling restrictions.

Both Allowed Lists and Disallowed Lists are assigned to individual extensions.

Disallowed Lists can also be used in conjunction with Remote Access to restrict calls made through the system from remote locations. In this case, Disallowed Lists can be assigned to either specific remote access barrier codes or (if barrier codes are not used) to specific types of lines/trunks (all tie/Direct Inward Dialing (DID) and all non-tie/non-DID trunks).



SECURITY ALERT:

Do not assign any Allowed List to a remote access barrier code or to the default class of restriction (COR) for all tie or all non-tie trunks. When used in conjunction with toll and local restrictions applied to the barrier code or COR, Allowed Lists do not work.

In Release 6.0 and later systems (Hybrid/PBX mode only), when a system's trunks are used by callers on remote systems to make outside calls, the system manager assigns Disallowed Lists to the Remote Access default tie and/or non-tie class of restriction. When a call crosses from one system to another in a network, the receiving system treats the call as a remote access call without a barrier code and consults the Disallowed Lists, along with other Remote Access default tie and/or non-tie settings (excluding the barrier code requirement), to permit or forbid the call.

When a Disallowed List is assigned to a barrier code, the remote access user using that code cannot reach the specific numbers included in the list.

If barrier codes are not used for remote access, then Disallowed Lists for remote access users can be assigned to all tie/DID trunks and all non-tie/non-DID trunks.

A Night Service Emergency Allowed List can be programmed with up to 10 numbers that anyone can dial without having to enter a Night Service password. For additional information, see [“Night Service” on page 458](#).

Star Codes and Allowed/Disallowed Lists

In some instances, after you dial a *star code* (a star digit followed by a 2- or 3-digit number), the central office provides a second dial tone as a prompt to enter more digits. Generally, this second dial tone is immediate. In cases when the second dial tone is delayed, however, system dialing restrictions can be circumvented.

In Release 3.1 and later systems, the system manager can enter the star digit (*) in Allowed List and Disallowed List entries. The communications system can also be programmed with a delay period (see [“Second Dial Tone Timer” on page 630](#)), during which no dialing is allowed while the central office dial tone returns. If dialing is attempted, the call is treated as though it had violated calling restrictions and is not completed.

The star codes that the system recognizes are as follows:

- 2-digit codes: *(00–19, 40–99)
- 3-digit codes: *(200–399)

Restrictions are reset after leading star codes. This means that any star codes that are not included in an Allowed or Disallowed List are not considered. The digits that follow the star code are then compared again to the lists. If a caller dials *67280, the Allowed/Disallowed List feature acts as though 280 were dialed. In this case, star codes do not need to be placed in an Allowed or Disallowed List to restrict calls to specific exchanges or area codes.

The programmed delay is also activated when, you dial the rotary telephone equivalent of a star code is dialed (for example, 1170). Multiple leading star codes (such as *67*70) are also handled by the system because the dialed number is checked against Allowed and Disallowed Lists after each star code is detected.

The following examples show how to set table entries to achieve specific results:

- Disallow calls preceded by *67, but allow all other calls:
Enter *67 as a Disallowed List entry.
- Disallow calls preceded by all star codes, but allow all other calls:
Enter * as a Disallowed List entry.
- Disallow calls preceded by *67 or *69, but allow all other calls:
Enter *67 as a Disallowed List entry, and enter *69 as a separate entry.
- Disallow calls preceded by *67, calls to 900 numbers and 411, but allow all other calls:
Enter *67, 900, and 411 as separate Disallowed List entries.

The following examples identify specific results that *cannot* be achieved through programming the system:

- Disallow *67 when dialing a specific exchange.

- Disallow *67 only when it is followed by *69.

Default Disallowed Lists

In Release 3.1 and later systems, the system is factory-set with a default Disallowed List (List 7), which includes the following entries: 0, 10, 11, 1809, 1700, 1900, 976, 1ppp976, * (p = any digit). This list is automatically assigned to any port programmed as a Voice Messaging Interface (VMI) port.



SECURITY ALERT:

The system manager should assign this list to any extension that does not need access to the numbers in the list. For Release 6.0 and later systems (Hybrid/PBX mode only), it is recommended that the system manager assign Disallowed List 7 to the Remote Access default COR for tie and/or non-tie trunks.

Disallowed Lists and VMI Ports

In Release 3.1 and later systems, ports assigned as Generic VMI or Integrated VMI are assigned the default Disallowed List.



SECURITY ALERT:

If the system manager wants to allow access to the voice messaging system Outcalling feature, any entries in the default Disallowed List apply to Outcalling calls. Any changes to the default Disallowed List entries and other restrictions must be considered carefully in order to minimize the potential for toll fraud.

If the system manager changes a port to a non-VMI port, the default Disallowed List is not removed from the port. If the default Disallowed List should be removed, the system manager must remove it from the port through system programming.

Considerations and Constraints

A Disallowed List takes precedence over an Allowed List. If a telephone number is on both an Allowed List and a Disallowed List assigned to an individual extension, the caller cannot complete a call to that number.

If a zero (0) is programmed as the first digit of an Allowed List entry, any toll restriction assigned to an extension is removed for calls placed through a toll operator.

Individual Allowed and Disallowed Lists are numbered 0 through 7. Within each list, there are 10 entries, numbered 0 through 9.

The Pause character (entered by pressing the Hold button) can be used as a wild card character in Disallowed Lists—for example, to indicate that calls to a given exchange are restricted in every area code. The Pause character is shown on the planning form as “p.” Wild card characters are not permitted in Allowed List entries. The Pause character does not act as a wild card for the * character.

When used in conjunction with Remote Access, Allowed and Disallowed Lists are assigned to specific barrier codes or to types of lines/trunks: all tie/DID trunks, or all non-tie/DID trunks. Allowed and Disallowed Lists cannot be assigned to trunks on an individual basis.

When used with Automatic Route Selection (ARS), Allowed and Disallowed Lists are not applied until the caller dials the ARS code and a pool is selected.

Because restrictions imposed by a Disallowed List apply to the extension used to initiate a call to an outside number, a user with a restricted extension can circumvent restrictions by asking an operator with an unrestricted console to connect an outside call.

Feature Interactions

Auto Dial

With a restricted extension, you cannot dial a restricted number (outside or toll) by using an Auto Dial button unless the number is on the Allowed List for that extension. You cannot dial an outside number by using an Auto Dial button if the number is on a Disallowed List.

Automatic Route Selection

ARS checks Allowed and Disallowed Lists before choosing the route for a call. This prevents users with restricted extensions from dialing numbers that are not on an Allowed List. ARS also prevents a user from dialing numbers on a Disallowed List.

Calling Restrictions

When used with calling restrictions, Allowed Lists can permit the dialing of specific numbers (such as emergency numbers) from an outward- or toll-restricted extension.

Disallowed Lists can prevent the dialing of specific numbers from either an unrestricted or a toll-restricted extension.

A Disallowed List takes precedence over an Allowed List.

Conference

With a restricted extension, you cannot add a participant (outside or toll) to a conference call unless the participant's number is on the Allowed List for that extension.

You cannot add an outside number to a conference call if the number is on a Disallowed List.

Direct-Line Console

Allowed and Disallowed Lists can be assigned to DLCs.

- Directories** If you have an outward- or toll-restricted extension, you cannot dial an outside number by using a Personal Directory or System Directory listing (excluding a marked System Directory listing), unless the number is on an Allowed List assigned to the extension.
- If a number is on a Disallowed List for an extension, you can dial it only by using a marked System Directory listing, not a regular Personal Directory or System Directory listing.
- Forward and Follow Me** With a restricted extension, you cannot forward calls to a restricted (outside or toll) number unless the number is on the Allowed List for that extension. If the number is on the Disallowed List for that extension, the call cannot be forwarded. When activating Remote Call Forwarding or Centrex Transfer via Remote Call Forwarding (Release 6.0 and later systems) on a restricted extension, you do not hear an error tone; however, when a call is received, the Forward is denied.
- HotLine** Allowed and Disallowed Lists can be assigned to HotLine extensions (Release 5.0 and later systems).
- Night Service** A Night Service Emergency Allowed List can be programmed with up to 10 numbers that you can dial without having to enter the Night Service password. For additional information, see [“Night Service” on page 458](#).
- Personal Lines** With a restricted extension, you cannot dial a restricted number (outside or toll) on a personal line button unless the number is on the Allowed List for that extension. If the number is on a Disallowed List, you cannot dial it.
- Recall/Timed Flash** If Recall is used on a personal line or Pool button—or, in Release 2.0 and later systems, on an SA or ICOM button—to access an outside loop-start line, the accessed line is kept, you hear an outside dial tone, and calling restrictions are reapplied.
- Remote Access** In releases prior to 6.0, Disallowed Lists are assigned as items of the COR for the Remote Access feature. When barrier codes are not used, Disallowed Lists are assigned to lines/trunks systemwide. When barrier codes are used, Disallowed Lists are assigned to individual barrier codes.
- Do not assign any Allowed List to a remote access barrier code or to the default COR for all tie and/or non-tie trunks. When used in conjunction with toll and local restrictions applied to the barrier code or COR, Allowed Lists do not work.
- In Release 6.0 and later systems (Hybrid/PBX mode only), for private trunks that will be used by remote networked users to access network trunks via ARS, default COR programming is used. Disallowed Lists should be programmed appropriately (all tie and/or all non-tie) for these trunks. Allowed Lists should not be used.

- Speed Dial** Using a marked System Speed Dial number (the dialed number is suppressed from the display) to dial a number overrides the calling restrictions (such as toll or outward restrictions, or Allowed and Disallowed Lists) assigned to that extension. When you use an unmarked System Speed Dial or a Personal Speed Dial number to dial a restricted number, the call cannot be completed unless the number is on the Allowed List for that extension.
- Tandem Switching** In Release 6.0 and later systems (Hybrid/PBX mode only), Disallowed Lists should be used for the default COR. You should use Disallowed List 7, which prohibits a variety of calls often made by toll fraud abusers. Review and add to this list as needed. When a Disallowed List is assigned, ARS calls cannot reach the specific numbers included on the list. When barrier codes are required for the default COR, Disallowed Lists should be assigned to individual barrier codes.
- Toll Type** When lines/trunks with different toll types are connected to the system (for example, basic lines/trunks and PRI facilities), a toll prefix (0 or 1) may be required for toll calls on some lines/trunks but not on others. In this case, two Disallowed List entries are required to restrict users from dialing specific area codes and/or telephone numbers. For example, to restrict users from dialing calls in the 505 area code on both toll types, one entry must be 1505 and the other entry must be 505. When the Disallowed List is assigned to an extension, the 505 entry restricts users from making calls to the 505 area code on lines/trunks that do not require a toll prefix, and the 1505 entry restricts users from making calls (including local calls) to the 505 area code on lines/trunks that *do* require a toll prefix. The same rules apply to Allowed Lists.
- UDP Features** For Release 6.0 and later systems (Hybrid/PBX mode only), Allowed and Disallowed Lists assigned to extensions are not used to restrict UDP calls.

Authorization Code

At a Glance

Users Affected	Telephone users, data users
Reports Affected	Extension Information, Authorization Code Information, SMDR
Modes	All
Telephones	All (touch-tone telephones except QCC)
Programming Code	*80
Feature Code	80
MLX Display Label	Auth Code [Auth]
System Programming	<p>Assign or remove Authorization Code for an extension:</p> <ul style="list-style-type: none"> ■ Extension→More→Auth Code→Enter <p>Assign home extension in SMDR Report:</p> <ul style="list-style-type: none"> ■ Options→SMDR→Auth Code→Home Extension Number <p>Assign actual authorization code in SMDR Report:</p> <ul style="list-style-type: none"> ■ Options→SMDR→Auth Code→Authorization Code <p>To print a report on all authorization codes on a system:</p> <ul style="list-style-type: none"> ■ More→Print→Auth Code
Maximums	
Number of Digits in Authorization Code	11 (range 2–11) (digits 0–9, *)
Factory Settings	
SMDR Report	Home Extension Number
Authorization codes	Not assigned to any extensions

Description

The Authorization Code feature allows you to pick up someone else's telephone, enter your authorization code, and complete a call with the restrictions that apply to your own telephone (*home extension*). This includes toll restrictions, outward restriction, Facility Restriction Level (FRL), Allowed Lists, Disallowed Lists, Forced Account Code Entry, Night Service Exclusion List, and dial access to pools. All other functions on the telephone are those of the extension you are

using, not your home extension. For Release 6.0 and later systems (Hybrid/PBX mode only), the Authorization code feature allows you to use your home extension FRL when placing private network calls.

Each entry of an authorization code provides restriction privileges for a single telephone call. If you put the first call on hold and start to make an outside call, the Authorization Code button's green LED goes off. If you wish to make another call, you must reactivate the Authorization Code feature in order to obtain the restriction privileges of the home extension. Authorization codes can also be used for call control and call accounting through the SMDR printout. SMDR may be programmed so that when no account code is entered, either the home extension number or the authorization code is recorded in the ACCOUNT field. The factory setting lists the home extension number in the ACCOUNT field.

An authorization code can range from 2 to 11 characters and must be unique across the system. However, more than one user can use an authorization code simultaneously. Authorization codes do not have a set, systemwide length.

Through system programming, the system manager can assign one authorization code for each extension. One Authorization Code button can be programmed on any multiline telephone (except QCCs). A button with an LED is recommended.

If a user does not have a physical telephone, a phantom extension may be programmed as a home extension to allow the user to use restricted telephones and for call control and accounting purposes.

The Authorization Code feature can be activated by modems, fax machines, and other devices that can dial or enter #80 and then the authorization code followed by a #.

In Release 6.0 and later systems, you can activate or deactivate forwarding features, including Centrex Transfer via Remote Call Forwarding but excluding Follow Me, at a telephone on the system by entering the authorization code for the extension in the same system from which calls are to be forwarded. This is useful for changing forwarding operations at phantom extensions and at single-line telephone extensions when a Pause is needed in the dialing sequence. (You cannot enter a Pause at a single-line telephone.) You enter the authorization code, then activate or deactivate the forwarding feature in the normal fashion. You must complete the activation or deactivation sequence within 15 seconds of entering the authorization code; otherwise, you will have to start over. This is the *only* feature that can be used by entering an authorization code in this fashion.

Activating an Authorization Code

You can pick up any telephone (except a QCC) in the system and use an authorization code. To obtain home extension calling privileges, enter your home

extension's authorization code in one of the following ways:

- Press a programmed Authorization Code button, and then enter the assigned authorization code.
- Press the Feature button on an MLX display telephone, and then select `Auth Code`.
- Press the Feature button on an MLX, ETR, MLS, or analog multiline telephone, and dial 80.
- Press #80 while off-hook on an SA/ICOM button.

If you activate the feature while on hook, the feature selects an SA/ICOM button and turns on the speakerphone, if present.

After you activate the feature, the green LED (if present) next to a programmed Authorization Code button starts to flash slowly to indicate that you may enter the code's digits. An MLX or ETR display telephone shows `Auth:`, and an analog multiline or MLS display telephone shows `Auth?`.

Entering an Authorization Code

While you enter the assigned authorization code, you hear an inside dial tone. If you do not enter the code within 15 seconds, the feature is deactivated.

If a telephone has a display, the display shows asterisks instead of the entered digits.

To complete entry of the authorization code, either press a programmed Authorization Code button again or dial a # to signify the end of the code. If the entered authorization code matches an assigned code, you continue to hear an inside dial tone and you can start dialing the telephone number.

The green LED associated with a programmed Authorization Code button becomes steady to indicate that an authorization code has been successfully entered. The LED remains steady as long as the Authorization Code feature remains active.

If the authorization code is not valid, you hear an error tone (a high tone followed by a low tone). The green LED associated with a programmed Authorization Code button goes off to indicate that the Authorization Code feature is not active. An MLX display telephone shows the message `Auth Code Not Valid`, and an analog multiline or MLS display telephone shows the message `ERROR`.

Deactivating an Authorization Code

Each entry of an authorization code is good for only one telephone call. After completing a call, the current extension loses home extension privileges. It also loses privileges for subsequent calls after putting a call on hold or after initiating Recall, Headset Hang Up, or Park features. If a far-end disconnect is not received from the central office, you must hang up or select another outside line to deactivate the Authorization Code feature.

After the feature is deactivated, the green LED next to the Authorization Code button (if present) turns off.

Considerations and Constraints

An authorization code can be entered only while hearing an inside dial tone.

Incoming calls are not affected by an authorization code.

There is no limit to the number of users who can use the same authorization code simultaneously.

Authorization codes cannot contain a # or begin with a *.

HotLine extensions cannot use authorization codes.

An authorization code must be at least 2 digits and no more than 11.

An authorization code must be unique across the system.

In Release 6.0 and later systems, you can activate or deactivate forwarding features (excluding Follow Me) at a system extension by entering the authorization code for the extension in the same system from which calls are to be forwarded. You enter the authorization code, then activate or deactivate the forwarding feature. You must complete the activation or deactivation sequence within 15 seconds of entering the authorization code; otherwise, you will have to start over. This is the *only* feature that can be used by entering an authorization code in this fashion.

Telephone Differences

Queued Call Console

The Authorization Code feature cannot be activated on a QCC.

Analog Multiline Telephones

At an analog multiline telephone connected to a General Purpose Adapter set for Auto operation, you must lift the handset before activating Authorization Code. Do not use the Spkrphone button.

Single-Line Telephones

On single-line telephones, you activate entry of an authorization code by dialing #80. You complete the entry you activate by dialing #. Single-line telephones must have touch-tone dialing and must be programmed through Idle Line Preference (using centralized telephone programming) to select an SA/ICOM button when you pick up the handset or activate the speakerphone.

On a single-line telephone, you enter an authorization code before accessing an outside line.

On a single-line telephone, you cannot enter authorization codes by using a System Speed Dial or Personal Speed Dial code because these features are activated by dialing #. Pressing # completes the entry of an authorization code; therefore, it cannot also be used to activate speed dial features.

Feature Interactions

Account Code Entry If you do not enter an account code, the ACCOUNT field of the SMDR printout contains the authorization code or the home extension used to obtain restriction privileges. If you enter an account code at any time during a call, the account code is stored in the SMDR record.

If the extension used to make a call is assigned Forced Account Code Entry, the caller is not forced to enter the account code while using the Authorization Code feature.

If the home extension is assigned Forced Account Code Entry, you must enter an account code before entering an authorization code.

Automatic Route Selection You can enter an authorization code before dialing the ARS access code. After dialing the ARS access code, you can enter an authorization code only if a Feature button or programmed Authorization Code button is used.

Centrex Operation In Release 6.0 and later Key or Hybrid/PBX mode systems, you can activate or deactivate forwarding features, including Centrex Transfer via Remote Call Forwarding but excluding Follow Me, at an extension on the system by entering the authorization code for the extension on the same system from which calls are to be forwarded. You enter the authorization code, then activate or deactivate the feature in the normal fashion. This is especially useful for a single-line telephone where you must include a Pause character in a Remote Call Forwarding dialing sequence, because the character cannot be dialed at a single-line telephone. It is also useful when you must change forwarding options for a phantom extension.

Conference You must enter an authorization code before each outside call for a conference. You may enter different authorization codes for different outside calls, which is useful if different privileges are needed for different outside calls.

Digital Data Calls Data calls can use authorization codes. If Account Code Entry is also used, you must enter the authorization code after the account code. Authorization codes can be used by video systems that allow the use of # for feature codes.

Forward and Follow Me In Release 6.0 and later Key or Hybrid/PBX mode systems, you can activate or deactivate forward features, including Centrex Transfer via Remote Call Forwarding but excluding Follow Me, at an extension on the system by entering the authorization code for the extension on the same system from which calls are to be forwarded. You enter the authorization code, then activate or deactivate the feature in the normal fashion. This is especially useful for a single-line telephone, where you must include a Pause character in a Remote Call Forwarding dialing sequence, since this character cannot be dialed at a single-line telephone. This is also useful when you must change forward options for a phantom extension.

Headset Options Pressing the Headset Hang Up button deactivates the Authorization Code feature.

Hold Initiating Hold after entering an authorization code deactivates the Authorization Code feature for subsequent calls.

Last Number Dial For security reason, an authorization code is not saved by the Last Number Dial feature. When you activate the Authorization Code feature, you cannot use Last Number Dial. After you turn off Authorization Code, you can use Last Number Dial to dial the most recent number dialed.

Night Service You can use an authorization code when Night Service is activated. For Night Service with Outward Restriction, you must enter a valid password before entering an authorization code.

- Park** Initiating Park after entering an authorization code deactivates the Authorization Code feature. You do not need to enter an authorization code to pick up a parked call.
- Remote Access** You cannot enter an authorization code on a remote access call.
- Saved Number Dial** For security, the authorization code is not saved by the Saved Number Dial feature.
- Authorization Code does not affect Saved Number Dial on the extension you are using or your home extension. You can retrieve the saved number on the telephone you are using.
- Speed Dial** You cannot enter authorization codes by using a System Speed Dial or Personal Speed Dial code because these features are activated by dialing #. Pressing # completes the entry of an authorization code and cannot also be used to activate speed dial features.
- SMDR** Outgoing calls made by using an authorization code are recorded in the SMDR record.
- If you do not enter an account code, the ACCOUNT field of the SMDR printout contains the authorization code used to obtain either restriction privileges or the home extension number. If you enter an account code at any time during a call, the account code is stored in the SMDR record instead.
- System Renumbering** Authorization codes are associated with logical IDs, not extension numbers. If extensions are renumbered and the logical IDs for the extensions change, the authorization codes may be reassigned to different extensions.
- Transfer** If you want to transfer a call to an outside number, you must enter the authorization code at the beginning of the transfer to obtain home extension privileges. In this case, one-touch Transfer does not work.
- UDP Features** For Release 6.0 and later systems (Hybrid/PBX mode only), you can enter your own authorization code and complete a private network call with the FRL assigned to your home extension.

Auto Answer All

At a Glance

Users Affected	Telephone users, DLC operators, data users
Reports Affected	Extension Information
Modes	All
Telephones	Analog multiline
Programming Code	*754
MLX Display Label	AutoAns All (in centralized telephone programming)
Hardware	General Purpose Adapter (GPA) needed to connect answering device to analog multiline telephone; 502C headset adapter needed for headset options.

Description

Auto Answer All is available on analog multiline telephones only (including analog DLCs with a modem, answering machine, or other answering device connected through a GPA) to answer both inside and outside calls when the user is not available.

To activate Auto Answer All, slide the switch on the GPA to Auto, and press the Auto Answer All button. The green LED next to the button turns on, and incoming calls are answered automatically.

To deactivate the feature, either slide the switch on the GPA to Basic, or press the Auto Answer All button. If you press the button to deactivate the feature, the green LED next to the button turns off. In either case, the telephone returns to normal operation.

Auto Answer All also can be used with a headset adapter to allow an analog multiline telephone user or analog DLC operator with a headset to be connected automatically to ringing calls. A tone heard through the headset signals an incoming call.

A programmed button activates and deactivates Auto Answer All. Select the lines to be answered by the device by programming Immediate Ring or Delay Ring as the ringing option. You should program lines that are not to be answered as No Ring.

Considerations and Constraints

When Auto Answer All is used, all voice announcements (including Voice Announce) should be disabled because the device connected to the GPA cannot answer voice-announced calls.

Auto Answer All cannot be used with a Hands-Free Unit (HFU).

Occasionally a second alert (or zip) tone may sound on incoming or intercom calls. This is normal.

Auto Answer All should be used instead of Auto Answer Intercom to allow an answering device to answer intercom calls. Auto Answer Intercom can cause intercom calls to be dropped.

Telephone Differences

Queued Call Consoles

Auto Answer All cannot be used on a QCC.

Other Multiline Telephones

Auto Answer All cannot be used on MLX telephones, cordless telephones, or wireless telephones.

Single-Line Telephones

Auto Answer All cannot be used on single-line telephones. This includes single-line telephones with speakerphones.

Some single-line telephones (such as the 8110) have their own telephone-based Auto Answer feature, which can be used with a Release 4.0 or later MERLIN LEGEND Communications System.

Feature Interactions

Auto Answer Intercom Both Auto Answer All and Auto Answer Intercom can be programmed on the same extension, but they cannot be used at the same time. Auto Answer Intercom should not be used with answering devices.

Auto Dial At an analog multiline telephone with a GPA connected and set for Auto operation, you must lift the handset before pressing an Auto Dial button. Do not use the Spkrphone button.

- Coverage** A sender or receiver at an analog multiline telephone can use Auto Answer All to have calls answered by an answering machine connected to the telephone.
- Forward and Follow Me** When Auto Answer All is activated, an answering device connected to an analog multiline telephone can answer forwarded calls.
- Group Calling** A calling group member with an analog multiline telephone can use Auto Answer All when an answering machine is connected to the extension. When the feature is activated, all incoming calls ringing on the group member's telephone (both calls for the calling group and calls to the group member's own extension) are answered automatically by the answering machine.
- Ringling Options** A General Purpose Adapter (GPA) connected to an analog multiline telephone answers calls on lines set for Immediate or Delay Ring. Program lines that are not to be answered for No Ring. If the device should answer only inside calls, Personal Lines must be set for No Ring.
- Service Observing** In Release 6.1 and later systems, calls answered by using Auto Answer All can be observed.
- System Access/ Intercom Buttons** When Auto Answer All is activated, incoming calls on SA Ring, ICOM Ring, SA Voice, or ICOM Voice buttons can be answered automatically by the device connected to a General Purpose Adapter (GPA).
- If SSA buttons are assigned, they should be programmed for either Delay Ring or No Ring, and the corresponding SA button at the principal extension should be programmed for Immediate Ring. This prevents calls to the principal extension from being answered simultaneously at the principal extension and at another device with a corresponding Shared SA button.
- Voice-announced calls received at an analog multiline telephone are not answered by a device connected through a GPA because ringing current is not sent to the device.
- Voice Announce** Voice-announced calls received at an analog multiline telephone are not answered by a device connected through a GPA because ringing current is not sent to the device.

Auto Answer Intercom

At a Glance

Users Affected	Telephone users, operators
Reports Affected	Extension Information
Modes	All
Telephones	Analog multiline
Programming Code	*753
MLX Display Label	AutoAnsIcom (in centralized telephone programming)
Hardware	Hands-Free Unit (HFU) is used to answer inside calls.

Description

Some older models of analog multiline telephones do not have built-in speakerphones. With these telephones, you can still answer inside calls without lifting the handset by using Auto Answer Intercom with an optional Hands-Free Unit (HFU).



NOTE:

MLX telephone users can automatically answer calls on their speakerphones if the Hands-Free Answer on Intercom button (HFAI) is activated.

To activate Auto Answer Intercom, press the Auto Answer Intercom button. The green LED next to the button turns on. The HFU turns on automatically when an inside call is received.

To deactivate the feature, press the Auto Answer Intercom button again. The green LED turns off, and the HFU does not automatically turn on when an intercom call is received.

Considerations and Constraints

Auto Answer All should be used instead of Auto Answer Intercom to allow an answering device to answer intercom calls. Auto Answer Intercom can cause intercom calls to be dropped.

When you activate Auto Answer Intercom in Hybrid/PBX mode and you receive a call on an SA button, the HFU turns on, even if the button is programmed for Delay Ring or No Ring.

Mode Differences

When you activate Auto Answer Intercom in Hybrid/PBX mode and you receive a call on an SA button, the HFU turns on, even if the button is programmed for Delay Ring or No Ring.

Telephone Differences

Queued Call Consoles

Auto Answer Intercom cannot be used on a QCC.

Other Multiline Telephones

Auto Answer Intercom cannot be used on MLX telephones, cordless telephones, or wireless telephones.

Single-Line Telephones

Auto Answer Intercom cannot be used on single-line telephones, whether or not they have speakerphones.

Some single-line telephones (such as the 8110) have their own telephone-based Auto Answer feature, which can be used with a Release 4.0 or later MERLIN LEGEND Communications System.

Feature Interactions

Auto Answer All	Both Auto Answer All and Auto Answer Intercom can be programmed on the same telephone, but they cannot be used at the same time.
Coverage	Auto Answer Intercom prevents a receiver on an analog multiline telephone from using a Hands-Free Unit (HFU) to answer calls received on a Primary Cover, Secondary Cover, or Group Cover button.
Primary Rate Interface and T1	Incoming calls on a line that is a member of a B-channel group programmed for routing by dial plan cannot be answered by HFAI.
Service Observing	In Release 6.1 and later systems, calls answered by using Auto Answer Intercom can be observed. Calls answered by using HFAI can be observed.
System Access/ Intercom Buttons	When you activate Auto Answer Intercom, the Hands-Free Unit (HFU) answers inside calls received on an SA button. The HFU does not answer calls on a Shared SA button.

Features

Auto Answer Intercom

61

UDP Features

In Release 6.0 and later systems (Hybrid/PBX mode only), Auto Answer Intercom and HFAI do not work for private network calls.

Auto Dial

At a Glance

Users Affected	Telephone users, DLC operators, data users
Reports Affected	Extension Information
Modes	All
Telephones	All except QCC and single-line telephones
Programming Codes	
Inside	*22 + ext. no.
Outside	*21 + number
MLX Display Labels	Auto Dial, Inside [AutoD,In] Auto Dial, Outside [AutoD,Out]
Maximums	28 digits, including special characters



CAUTION:

Before testing emergency numbers, call the regular number for the organization that each emergency number reaches. Find out the correct procedure for testing an emergency number without disrupting emergency operations.

Description

Use Auto Dial buttons for one-touch dialing of frequently called telephone numbers. You can program two types of Auto Dial buttons:

- **Inside Auto Dial.** This button automatically dials any extension or group extension in the system—such as a co-worker, calling group, fax machine, or voice mail system. An operator can also program inside Auto Dial buttons for park zone extension numbers.

When an inside Auto Dial button is programmed, you can see the status of the extension associated with the button; the green LED next to the button is on when a person at the extension is on a call, when Do Not Disturb is on, or when the extension is forced idle for centralized telephone programming or system programming.

- **Outside Auto Dial.** This button automatically dials frequently called telephone numbers, as well as account codes, long-distance company access codes, bank access codes, or emergency contact numbers.

Considerations and Constraints

When an Auto Dial button is used to make a call, the green LED next to the button does not turn on.

Only company extension numbers should be programmed on inside Auto Dial buttons. Account codes, long-distance company access codes, and outside telephone numbers should be programmed on outside Auto Dial buttons.

If you try to program an incomplete extension number on an inside Auto Dial button, the system provides an error tone and the button remains as programmed.

If numbers are dialed incorrectly by outside Auto Dial, it is possible that the digits are being dialed before a central office dial tone is received. In this case, a Pause character should be programmed as the first digit of the dialed number in Key mode or as the digit after the dial-out code in Hybrid/PBX mode.

Inside Auto Dial does not work across a private network. Use Outside Auto Dial for calls that travel across the private network.

To enter special characters in a telephone number programmed on an outside Auto Dial button, use Conf for the Flash character, Drop for the Stop character, and Hold for the Pause character (see [Table 1](#)). These special characters cannot be programmed on inside Auto Dial buttons. If the Stop character is the last character in the number, it has no effect on how the Auto Dial button functions.

Table 1. Special Characters for Outside Auto Dial

Press...	See ¹ ...	Means...
Drop ²	s	Stop. Halts dialing within a sequence of automatically dialed numbers. For example, an outside Auto Dial button may be programmed with a password and a Stop, followed by a telephone number. To use Auto Dial with a Stop in the sequence, press the button to dial the password, listen for the dialing and connection, and press the button again to dial the telephone number.
Hold	p	Pause. Inserts a 1.5-second pause in the dialing sequence. Multiple consecutive pauses are allowed.
Conf ²	f	Flash. Sends a switchhook flash. Must be the first entry in the dialing sequence.
##	#	End of Dialing (for extension programming only). Use at the end of a dialing sequence to indicate that you have finished dialing or to separate one group of dialed digits from another, such as account code and number dialed.
#	#	End of Dialing. Use at the end of a dialing sequence to indicate that you have finished dialing or to separate one group of dialed digits from another.

1 Display telephones only.

2 Not available on MLC-5 cordless telephones.

In Release 2.1 and later systems, when a call is forwarded to a multiline telephone that has an inside Auto Dial button programmed for the forwarding telephone, the green LED next to the Auto Dial button does not flash.

Mode Differences

Hybrid/PBX Mode

In Hybrid/PBX mode, the system automatically turns on the speakerphone and selects an SA button when you press an inside or outside Auto Dial button before lifting the handset.

Key Mode

In Key mode, the system automatically turns on the speakerphone and selects an outside line button when you press an outside Auto Dial button without lifting the handset. When you press an inside Auto Dial button without lifting the handset, the system automatically turns on the speakerphone and selects an ICOM button.

Behind Switch Mode

In Behind Switch mode, the system automatically selects the prime line button and turns on the speakerphone whenever the user presses an outside Auto Dial button. If the Automatic Line Selection sequence has been changed to select the ICOM button, press the prime line or outside line button before pressing an outside Auto Dial button. Pressing an inside Auto Dial button without lifting the handset turns on the speakerphone; the system automatically selects an ICOM button but not an outside line.

Telephone Differences

Direct-Line Consoles

Inside Auto Dial can be programmed onto available buttons on a DLC. Use the buttons to transfer a call, make an inside call, or determine availability of the extension.

Queued Call Consoles

Use the Personal or System Directory instead of outside Auto Dial buttons, which cannot be programmed on the QCC. The Extension Directory or Direct Station Selector (DSS) buttons can be used instead of inside Auto Dial buttons.

Other Multiline Telephones

With all multiline telephones, you can program and use Auto Dial buttons. When using an MLX-20L telephone, use Personal Directory in place of Auto Dial. On an MLX display telephone, select the feature from the display to program it.

At an analog multiline telephone connected to a GPA set for Auto operation, you must lift the handset before pressing an Auto Dial button. Do not use the Spkrphone button.

Single-Line Telephones

With single-line telephones, you cannot program Auto Dial buttons.

Feature Interactions

Account Code Entry	You can program frequently used account code numbers onto outside Auto Dial buttons.
Allowed/ Disallowed Lists	With a restricted extension, you cannot dial a restricted number (outward or toll) using an Auto Dial button unless the number is on the Allowed List for that extension. You cannot dial an outside number using an Auto Dial button when the number is on a Disallowed List assigned to the extension.
Auto Dial	At an analog multiline telephone with a GPA connected and set for Auto operation, you must lift the handset before pressing an Auto Dial button. Do not use the Spkrphone button.
Automatic Route Selection	You cannot program ARS dial-out codes on inside Auto Dial buttons. You can program an ARS dial-out code on an outside Auto Dial button.
Conference	Press the Conf button to enter the Flash special character in a telephone number programmed on an outside Auto Dial button. Press the Drop button to enter the Stop special character in a telephone number dialing sequence programmed on an outside Auto Dial button.
Digital Data Calls	A terminal adapter can make a call by using an Auto Dial button by dialing the virtual number of the Auto Dial button (for example, #01). A video system that supports the use of # for entering feature codes can use Auto Dial in the same fashion.
Direct-Line Console	An inside Auto Dial button can be programmed on a DLC. A DLC operator can use the button to transfer a call, make an inside call, or determine whether or not the extension is available.

- Display** When you press a programmed Auto Dial button, the digits show on the display as if you were dialing from the dialpad. The number is dialed automatically (special characters for dialing strings are described in Appendix H). If the Auto Dial number includes a Stop character, press the Auto Dial button to complete dialing.
- Do Not Disturb** When you activate Do Not Disturb, the green LED next to all inside Auto Dial buttons programmed at your extension turns on.
- Forward and Follow Me** When a call is forwarded to a multiline telephone that has an Auto Dial button programmed for the forwarding telephone, the green LED next to the Auto Dial button does not flash.
- You cannot use an Auto Dial button to dial digits for any type of Remote Call Forwarding.
- Group Calling** The Calls-in-Queue Alarm button for a calling group is assigned on a multiline telephone by programming an inside Auto Dial button with the calling group's extension number.
- When a DSS is not available, the group supervisor uses Auto Dial buttons programmed with each calling group member's extension to monitor group member availability.
- Headset Options** If headset operation is activated on the telephone or console, select a line button before using Auto Dial to dial an extension or an outside number.
- Hold** The Hold button is used to enter the Pause special character in a telephone number programmed on an Auto Dial button.
- Last Number Dial** A number you dial by pressing a programmed outside Auto Dial button is saved for Last Number Dial as if you dialed it with the dialpad; however, special characters do not work. An extension dialed when you press a programmed inside Auto Dial button is not saved for Last Number Dial.
- Microphone Disable** If an MLX telephone has a disabled microphone, you can press an Auto Dial button to turn on the speakerphone so you can hear the number being dialed. You must, however, lift the handset to talk once the call is answered.
- Paging** You can program an extension for a speakerphone paging group on an inside Auto Dial button.
- Park** An operator can program park zone codes on inside Auto Dial buttons. An inside Auto Dial button can also be programmed with a user's or system operator's own extension number and can be used to park calls. When the system is programmed for one-touch Hold with manual completion, you hear a busy signal when parking a call at your own extension number and must complete the transfer by hanging up or pressing the Transfer button.
- Personal Lines** You can only use an outside Auto Dial button—not an inside one—on a personal line.

- Pools** Pool dial-out codes cannot be programmed on inside Auto Dial buttons. A pool dial-out code can be programmed on an outside Auto Dial button when a telephone number is also included. Depending on the local telephone company, however, Pause characters may be required before the telephone number. Pause characters are entered by pressing the Hold button.
- Recall/Timed Flash** Use the Conf button to enter the Flash special character, which simulates pressing the Recall button, in a telephone number dialing sequence programmed on an Auto Dial button.
- If you use Recall during an inside call made on an Auto Dial button, the call is disconnected and you hear an inside dial tone.
- Saved Number Dial** A number dialed by pressing a programmed outside Auto Dial button is stored for Saved Number Dial as though it were dialed with the dialpad, but special characters do not work. An extension dialed by pressing a programmed inside Auto Dial button is not stored for Saved Number Dial.
- Service Observing** In Release 6.1 and later systems, Service Observers can use Inside Auto Dial and DSS buttons to select extensions they want to observe.
- If an observed extension uses one-touch Transfer (automatic or manual), the observer is removed from the call when the call is placed on Hold for the transfer. If an observed extension uses one-touch Hold, the observer is removed from the call; however, the Service Observing session is still enabled. If the Service Observer tries to use one-touch Transfer or Hold while observing an extension, nothing happens.
- If a Service Observer has Auto Dial buttons programmed for extensions in its Service Observing group, an incoming call that can be observed lights the green LED next to the Auto Dial button. However, the green LED is not a guarantee that an observable call has arrived; it may simply mean the extension has activated Do Not Disturb.
- Calls made by using Auto Dial Outside can be observed.
- Signal/Notify** You cannot program a Signal button and an Auto Dial button for the same extension. Attempting to program both types of buttons for one extension causes the system to erase the button that has been programmed first.
- SMDR** Auto Dial calls to outside numbers are recorded by SMDR following the same rules that apply to other outside calls.

**System Access/
Intercom Buttons**

When you press an inside Auto Dial button, the system automatically selects an SA or ICOM button and turns on the speakerphone. When you press an outside Auto Dial button, the system automatically selects an outside line button in Key mode, a prime line button in Behind Switch mode, or an SA button in Hybrid/PBX mode.

Transfer

To transfer calls, you can press inside Auto Dial buttons instead of dialing extension numbers. To use the one-touch Transfer option, you must program inside Auto Dial buttons for extensions to which you transfer calls. When an operator transfers a call and it returns unanswered, the green LED next to the Auto Dial button flashes to indicate the extension from which the call is returning. Only system operators receive this indication.

UDP Features

In Release 6.0 and later systems (Hybrid/PBX mode only), non-local extension numbers can be programmed on outside Auto Dial buttons but *not* on inside Auto Dial buttons.

Automatic Line Selection and Ringing/Idle Line Preference

At a Glance

Users Affected	Telephone users, operators, data users		
Reports Affected	Extension Information		
Modes	All		
Telephones	All		
Programming Codes			
Ringing/Idle Line Preference			
On	*343		
Off	*344		
ALS sequence	(centralized telephone programming only for single-line telephones)		
Begin button sequence	*14		
End button sequence	**14		
MLX Display Labels	Line Prefer [LnPrf] AutoLineSel (centralized telephone programming only)		
Maximums			
Buttons for each extension in ALS sequence	8		
Factory Settings			
Ringing/Idle Line Preference	On		
ALS Sequence by Mode	Hybrid/PBX	Key	Behind Switch
MLX Telephone	3 SA	8 personal lines	1 prime line
Analog Multiline Telephones	3 SA	8 personal lines	1 prime line
Single-Line Telephones	3 SA	2 ICOM	1 prime line
Direct-Line Consoles	2 SA + 6 personal lines	8 personal lines	1 prime line + 7 personal lines
Queued Call Consoles	5 Call (fixed)		

Description

Automatic Line Selection (ALS) and Ringing/Idle Line Preference are two closely related features. Ringing/Idle Line Preference directs the system to automatically select a specific line button for making or answering a call, while ALS specifies the order in which buttons are selected.

Ringling/Idle Line Preference

Ringling/Idle Line Preference is a single option that controls two aspects of an extension's behavior: selection of a line when a call arrives and selection of a line when a user hangs up. Turn this option on or off for each extension either through extension programming or centralized telephone programming, using the display or programming codes. When Ringling/Idle Line Preference is on for an extension, the system selects a line button automatically, as follows:

- **Ringling Line Preference.** Selects a ringling outside line, SA button or ICOM button, or Cover button—that is, the red LED turns on next to the button with the ringling call. If you lift the handset or press the Speaker button, you are automatically connected to the ringling call.

The button must be programmed for Immediate Ring or Delay Ring. The red LED next to a button programmed for No Ring does not turn on unless you press that button to select that line. See [“Ringling Options” on page 618](#) for additional information.

- **Idle Line Preference.** Selects an available outside line, SA, or ICOM button for an outgoing call. If you lift the handset or press the Speaker button when no call is ringling, the red LED turns on next to an available line button, and you are automatically connected to that line.

The factory setting for Ringling/Idle Line Preference is on for all extensions. If Ringling/Idle Line Preference is turned off for an extension, no line button at that extension is ever selected automatically. The red LED is never on until you press the line button with a ringling call (flashing green LED) or an available line button (green LED off) to make a call.

Automatic Line Selection

When Ringling/Idle Line Preference is turned on at an extension, the system uses the programmed ALS sequence to select an idle SA or ICOM button, or outside line button for originating a call. When you lift the handset or press the Speaker button without selecting a line button, the red LED next to the first button in the programmed sequence turns on, and you are connected to that line. If the first line is busy, the system selects the second button in the sequence, and so on.

For example, if you normally make toll calls, a WATS line assigned to the extension can be programmed as the first line in the sequence, and local lines as the second, third, and so on. When you lift the handset or press the Speaker button, the WATS line, if available, is selected automatically.

On a multiline telephone, override ALS by pressing the desired line button before you lift the handset or press Speaker. The red LED next to the button goes on.

Up to eight line buttons (except on single-line telephones) can be programmed in the ALS sequence for an extension, either through centralized telephone programming or through extension programming, using programming codes only.



NOTE:

Your current Automatic Line Selection table is deleted immediately after you press *14. There is no way to cancel the operation. You must program new selections and then press **14 to end the operation.

[Table 2](#) shows the factory-set ALS sequence for each kind of telephone according to operating mode. When Ringing/Idle Line Preference is on, buttons are selected in the order shown. For multiline telephones, including operator consoles, the factory-set sequence begins with the lower left button, moves up in the first column of buttons, then moves to the bottom of the next column on the right, and finally moves up until the maximum of eight buttons is included in the sequence. When outside line buttons are part of the sequence, they are selected in numeric order (by default, 801, 802,...), up to the maximum number of lines shown.

Table 2. Factory-Set Automatic Line Selection Sequence

Telephone	Hybrid/PBX		Key Mode		Behind Switch	
Multiline (MLX, ETR, MLS, or Analog)	3. SA O 2. SA V 1. SA R		3. Line 3 2. Line 2 1. Line 1	8. Line 8 7. Line 7 6. Line 6 5. Line 5 4. Line 4	1. Prime line	
Single-Line	3. SA O 2. SA R 1. SA R		2. ICOM R 1. ICOM R		1. Prime line	
Direct-Line Consoles (MLX or Analog)	5. Line 3 4. Line 2 3. Line 1 2. SA V 1. SA R	8. Line 6 7. Line 5 6. Line 4	3. Line 3 2. Line 2 1. Line 1	8. Line 8 7. Line 7 6. Line 6 5. Line 5 4. Line 4	3. Line 3 2. Line 2 1. Prime line	8. Line 8 7. Line 7 6. Line 6 5. Line 5 4. Line 4
Queued Call Console (MLX only)	5. Call 5 4. Call 4 3. Call 3 2. Call 2 1. Call 1					

Where:

SA R, ICOM R = SA Ring, ICOM Ring

SA V, ICOM V = SA Voice, ICOM Voice

SA 0, ICOM 0 = SA Originate Only, ICOM Originate Only

Considerations and Constraints

Outside line buttons and SA or ICOM buttons can be included in the ALS sequence. Inside and outside lines, however, should not be interleaved. A typical sequence would consist of all desired SA or ICOM buttons, followed by all desired outside line buttons.

When personal line or Pool buttons are assigned to a single-line telephone or other tip/ring device (such as a fax machine) connected to a 012 (T/R) module, a 016 (T/R) module, or a Multi-Function Module (MFM), the buttons are automatically added to the ALS sequence.

When a user or system manager enters ALS programming, the system clears the current ALS sequence for the extension. If the person programming the extension exits without selecting any buttons, the extension has no ALS sequence. The effect is as if Idle Line Preference has been turned off: no line is selected automatically when the user lifts the handset to place a call.

Mode Differences

Hybrid/PBX Mode

The factory-set ALS sequence for multiline and single-line telephones includes only SA buttons. Make outside calls by dialing the main pool dial-out code (usually 70) or ARS code (usually 9).

In Release 3.0 and earlier systems, the factory setting allows you access to pools. In Release 3.1 and later systems, the factory setting restricts access to pools or to ARS. In order for you to access the main pool, the system manager must use system programming to remove the restriction for the specific extension.

Key Mode

The factory-set ALS sequence for multiline telephones (including DLCs) includes only personal line buttons. You can make inside calls by pressing an available ICOM button before dialing.

The factory-set ALS sequence for single-line telephones includes only ICOM buttons. You can make outside calls by dialing the Idle Line Access code (usually 9).

Behind Switch Mode

The factory-set ALS sequence includes only the prime line. The sequence can be changed to an ICOM line followed by the prime line or outside lines. This allows a single-line telephone user to use system features and to select the prime line and/or outside lines by dialing the Idle Line Access code (usually 9).

Telephone Differences

Queued Call Consoles

The ALS sequence on a QCC starts at the lowest Call button and moves upward, and Ringing/Idle Line Preference is on. Neither can be changed.

Other Multiline Telephones

The ALS sequence is assigned either through extension programming, using programming codes only, or through centralized telephone programming.

Single-Line Telephones

The ALS sequence for a single-line telephone can be changed only through centralized telephone programming. It cannot be changed by the telephone user.

The ALS sequence for single-line telephones and other tip/ring equipment connected to 012 (T/R) modules, 016 (T/R) modules, 008 OPT modules, or Multi-Function Modules is factory-set to include only SA or ICOM buttons. As outside lines or pools are assigned to the extension, they are automatically added to the ALS sequence.

In Key mode, if the ALS sequence for a single-line telephone is changed to include only outside lines, you cannot use system features except by pressing and releasing the Recall or Flash button. (If the telephone does not have positive disconnect, you can press and release the switchhook.)

In Behind Switch mode, the factory setting for the ALS sequence is the prime line. The sequence can be changed to an ICOM button followed by the prime line or outside lines. This allows a single-line telephone user to use system features and to select the prime line and/or outside lines by dialing the Idle Line Access code.

Feature Interactions

Account Code Entry	With a single-line telephone, you can enter account codes only when ALS is programmed to select an SA or ICOM button when you lift the handset.
Coverage	When Ringing/Idle Line Preference is on for an extension, the system automatically selects a Primary Cover, Secondary Cover, or Group Cover button with a ringing call. These buttons cannot be programmed in an ALS sequence, however, because they cannot be used to make calls.
Headset Options	Automatic Line Selection does not work when an MLX telephone or console is in headset operation. A headset user must select a line manually before making a call. If Headset Auto Answer is off, manually select a ringing line to answer the call.
Multi-Function Module	When an MFM is installed in an MLX telephone, the ALS sequence for the MFM should be set to select SA Ring or ICOM Ring, then SA Originate Only or ICOM Originate Only, then outside lines (or the prime line in Behind Switch mode) assigned to the MFM. Ringing/Idle Line Preference should be on for an MFM.
Ringing Options	Even when Ringing/Idle Line Preference is on, the system does not automatically select an outside line, SA, ICOM, or Cover button programmed for No Ring. If a call is coming in on such a button, select the button manually to answer. The green LED flashes when the call arrives; the red LED turns on when you press the button.
Service Observing	In Release 6.1 and later systems pressing a Service Observing button selects an SA or SSA button, regardless of the programming for Idle Line Preference.
System Access/ Intercom Buttons	SA buttons (including Shared SA buttons) or ICOM buttons can be programmed as part of an ALS sequence. You should not interleave different button types (personal line, Pool, SA, or ICOM). For example, in Hybrid/PBX or Key mode, the sequence might include all SA or ICOM buttons first, then Pool, then personal line buttons.
Transfer	ALS does not apply when the Transfer button is pressed.

Automatic Maintenance Busy

At a Glance

Users Affected	Telephone users, operators, data users
Reports Affected	System Information (SysSet-up)
Mode	Hybrid/PBX
System Programming	System→MaintenBusy

Description

When Automatic Maintenance Busy is enabled, a malfunctioning loop-start, ground-start, or tie line/trunk is automatically put in a maintenance-busy state, preventing outside calls from being made on that line/trunk. Incoming calls are never blocked.

In general, the two reasons for putting an outside line in a maintenance-busy state are as follows:

- Faulty or delayed signaling between the system and the central office. To avoid busying out lines because of slow telephone company central office responses rather than faulty lines/trunks, four consecutive occurrences of faulty or delayed signaling are required before the line/trunk is put in maintenance-busy state.
- Central office failure to disconnect (make the line/trunk available for use) after a user hangs up. The line/trunk is put in maintenance-busy state after two occurrences of a failure to disconnect.

When a line/trunk is placed in a maintenance-busy state, an error is recorded on the internal error log. The log indicates which type of error occurred: faulty or delayed signaling, or central office failure to disconnect.

Once a line/trunk is in a maintenance-busy state, the three ways to clear the condition and put the line/trunk back into service are as follows:

- Periodic testing of the line/trunk by the system's internal maintenance software to verify proper functioning.
- Manual clearing of the error from the error log.
- Manual seizure of the line/trunk at an operator console or through maintenance dial codes.

Considerations and Constraints

Incoming calls are received and processed normally on lines/trunks that are in a maintenance-busy state.

DID trunks (Hybrid/PBX mode only) are not affected by Automatic Maintenance Busy because these trunks can only receive calls and are not pooled.

100D (DS1) modules configured as ground-start, loop-start, or tie lines/trunks are monitored and maintained by Automatic Maintenance Busy.

No more than 50 percent of the lines/trunks in a pool can be placed in a maintenance-busy state at one time, *except* when the central office has failed to disconnect a line/trunk (preventing its use) or when an entire line/trunk module is manually taken out of service (called a *user-imposed* maintenance-busy state). In the case of the 100D module, any failure in the DS1 link causes the module to generate a loss-of-service alarm, and the entire module is taken out of service.

Mode Differences

Hybrid/PBX Mode

To provide optimal performance, Automatic Maintenance Busy should be enabled whenever a Hybrid/PBX system includes pools.

Key and Behind Switch Modes

Automatic Maintenance Busy is not available in Key and Behind Switch modes.

Feature Interactions

Alarm	The red LED next to the Alarm button on system operator consoles turns on, and the designated maintenance alarm alert device sounds or flashes when more than 50 percent of the lines/trunks in a pool are in a maintenance-busy state.
Automatic Route Selection	If you use ARS to make an outside call, the system selects another line/trunk in the pool when the first line/trunk is in maintenance-busy state.
Pools	To provide optimal performance, Automatic Maintenance Busy should be enabled whenever a Hybrid/PBX system includes pools.

Automatic Route Selection

At A Glance

Users Affected	Telephone users, operators, data users
Reports Affected	ARS, Extension Directory, Extension Information, Remote Access (DISA) Information
Mode	Hybrid/PBX only
Telephones	All
System Programming	<p>Specify the type of table (6-digit, area code, local exchange, or 1 + 7) and the area codes and/or exchanges to be included in the table:</p> <ul style="list-style-type: none"> ■ Tables→ARS→ARS Input <p>Specify that 1 + 7 tables should be searched when a leading 1 is dialed:</p> <ul style="list-style-type: none"> ■ Tables→ARS→ARS 1 + 7Dial <p>Specify time of day when calls are routed by using Subpattern A or B routing information:</p> <ul style="list-style-type: none"> ■ Tables→ARS→Sub B Start/Stop <p>Identify the pools (up to six) on which calls are to be routed:</p> <ul style="list-style-type: none"> ■ Tables→ARS→Sub A FRL/Sub B FRL <p>Specify the number of digits that need to be absorbed by the system when it routes calls on an identified route:</p> <ul style="list-style-type: none"> ■ Tables→ARS→Sub A Absorb/Sub B Absorb <p>Specify the digits or special characters that must be added by the system to the number dialed by a user when calls are routed on an identified route:</p> <ul style="list-style-type: none"> ■ Tables→ARS→Sub A Digit/Sub B Digit <p>Specify the FRL and/or digits that must be added when people dial emergency numbers in the Special Numbers (N11) table:</p> <ul style="list-style-type: none"> ■ Tables→ARS→More→Spec1Number→ARS FRL/ARS Digit <p>Specify the pool routing, FRL, and digits or special characters that must be added by the system to the number dialed by a user when calls are routed on the Dial 0 table:</p> <ul style="list-style-type: none"> ■ Tables→ARS→More→Dial 0→ARS Pool/ARS FRL/ARS Digits

Specify whether a route is to be used for voice, data, or both on a T1, BRI, or PRI call:

- Tables→More→Sub A Data/Sub B Data
- Tables→ARS→Sub A Pools/Sub B Pool

Assign or remove the FRL associated with each route:

Allow or restrict remote access users (without barrier codes) from using selected lines/trunks (including ARS calls placed over a private network for Release 6.0 or later systems):

- LinesTrunks→RemoteAccss→Non-TIE/TIE
 Lines→ARS Restrct

Allow or restrict remote access users (with barrier codes) from using selected lines/trunks (including ARS calls placed over a private network for Release 6.0 or later systems):

- LinesTrunks→RemoteAccss→BarrierCode→
 ARS Restrct

Assign or restrict extensions from using selected lines/trunks:

- Extensions→ARS Restrct

Maximums

Programmable Routing Tables	16 (1–16)
Entries for each table	100
Factory-set tables	4: Dial 0 (table 19), Special Numbers (N11, table 20), Default Toll (table 17), Default Local (table 18)
Subpatterns	2 for each programmable table
Routes	6 (1–6) for each subpattern
Absorbed digits	11 (0–11) for each route
System-prefixed characters	20 (0–9, *, and Pause) for each route

Factory Settings

ARS dial-out code	9
FRL for routes assigned to Default Toll table	3 (0–6; 0 least restrictive, 6 most restrictive)
FRL for routes assigned to Default Local table	2 (0–6; 0 least restrictive, 6 most restrictive)
FRL for VMI ports	0
(Release 3.1 or later systems)	3 (0–6; 0 most restrictive, 6 least restrictive)
FRL for extensions	3 (0–6; 0 most restrictive, 6 least restrictive)
FRL for Remote Access barrier codes and trunks	
Time to Start	00:00 (midnight, both Subpattern A and B)
System-prefixed characters	None
Absorbed digits	0
1 + 7 dialing requirements	Not within area code
Data	Both

Description

ARS is available only in Hybrid/PBX mode. ARS allows outgoing calls to be dynamically routed over selected facilities after dialing an ARS access code (usually 9). This enables the system to select the least expensive route for each call.

**NOTE:**

In Release 6.0 and later systems (Hybrid/PBX mode only), local system users can use ARS to access lines/trunks connected to another MERLIN LEGEND Communications System or to a DEFINITY Enterprise Communications Server (ECS) or DEFINITY ProLogix Solutions system. The connection to the networked system is made by using tandem tie (T1-emulated or analog) or tandem PRI trunks. Details about setting up and planning this functionality are provided in [“Tandem Switching” on page 699](#). Detailed information about private networks is included in the *Network Reference*.

Programmable lists, called *tables*, indicate the desired routes (line/trunk facilities) for specified area codes and/or exchanges. There is a different ARS table for each type of call (local, toll, special number, and so on). The tables are chosen according to the telephone number digits that are dialed by a user. Each ARS table has a particular pool to which it routes calls.

A table contains some or all of the following types of information:

- **Table Type.** Indicates how to interpret the information in the table. Table types are: Area Code, Local Exchange, 6-Digit, 1 + 7, Dial 0, Special Numbers (N11), Default Toll, and Default Local. Details for each table type are discussed later in this section.
- **Digit Strings.** Table includes 3-digit entries, usually area codes or exchanges. Dialed digits are compared to the stored digits. A match should occur in only one table and cause selection of the routes in that table.
- **Subpattern.** An array of up to six routes. There are two subpatterns for all tables except the Special Numbers (N11) and Dial 0 tables. The subpattern selected depends on the time of day that the call is made and the start time associated with each subpattern. (The start time for Subpattern A is specified as the stop time for Subpattern B.)

The Special Numbers (N11) Table always uses the main pool and thus has neither subpatterns nor routes. The Dial 0 Table has no subpatterns and only one route.

- **Routes.** A structure that defines possible lines/trunks to be used in a preferred order, usually based on the lowest cost and the extension user's privilege level or FRL. Routes cannot be programmed for the Special Numbers (N11) Table.

A route contains the following types of information.

- **Pool.** A group of lines/trunks that are to be used for this route. A pool must be programmed before any other route information.

 **NOTE:**

If you are using data in your system, program pools, including the default pool, for the proper data type. For example, a pool with T1 data-only lines cannot be used for voice calls. Loop-start, ground-start, T1 voice, and some PRI lines support only voice and analog data calls, while BRI lines and other PRI lines support both voice and digital data calls.

- **Facility Restriction Level.** A value from 0 to 6 associated with the route. For routes, 0 is the least restrictive and 6 the most restrictive value. In order to use a route, a caller (according to extension or remote access barrier code/trunk) must have an FRL that is equal to or greater than the FRL of the route.
- **Absorbed Digits.** The number (0–11) of user-dialed digits that ARS absorbs (does *not* dial out) on this route. Digits are absorbed starting with the first user-dialed digit, after any leading star codes.
- **System-Prefixed Digits.** A string of up to 20 digits (0–9, *, and Pause) that ARS dials out on this route *before* dialing any remaining user-dialed digits but after dialing any user-dialed leading star codes.

ARS allows up to 16 programmable tables, each of which may contain one of the following types of information:

- **Area Code Tables.** These tables are lists of 3-digit area codes. Area code tables are useful when just one type of line/trunk (for example, a regional WATS trunk) is used for all calls to each area code on the list.
- **Local Exchange Tables.** These tables list 3-digit exchanges within the local area code. They can be used to route calls over in-state WATS lines.
- **6-Digit Tables.** If the cost of calls to another area code varies according to the exchange, this table can be used to route calls on different pools, depending on both the area code and the exchange.

In a 6-Digit Table, an area code is the first entry. The remaining 99 entries are exchanges within the area code. The system scans the first six digits of the user-dialed number (area code and exchange) to route the call.

- **1 + 7 Tables.** In some areas, callers must dial a 1 and a 7-digit number to call certain exchanges, even though the call is within the local area code. A 1 + 7 Table contains a list of local area code exchanges that require dialing a 1, but not an area code before the 7 digits.

In addition to the fully programmable tables, ARS has four factory-set tables:

- **Dial 0 Table.** This factory-set table routes calls to numbers that start with 0. The international dialing code, 011, is treated as a special case and can be put into a programmable table. If 011 is not specified in a programmable table, international calls are routed through the Dial 0 Table. Programming of this table is limited to a single pool, its FRL, and system-prefixed digits.
- **Special Numbers (N11) Table.** This factory-set table routes calls to the special numbers 411, 611, 811, and 911. The main pool is always used. The pool routing for this table is not programmable.

**CAUTION:**

Unless networked systems are collocated, each system should have at least one loop-start line connected to the PSTN. The line is required to allow connection of a power-failure telephone to the Power-Failure Transfer (PFT) jack on a module as a power outage backup and for correct routing of emergency and other N11 calls. To ensure that the correct services are reached, if the loop-start line is used for emergency or other N11 calls, it should be assigned to the main pool. In this case, IXC calls determine the number of loop-starts required. See [“Power-Failure Transfer” on page 507](#) of this guide for more information.

- **Default Toll Table.** This factory-set table routes toll calls to numbers that do not match entries in any of the area code, 6-digit, or 1 + 7 digits tables. This table has two subpatterns of up to six routes each, but neither absorbed digits nor system-prefixed digits are used.
- **Default Local Table.** This factory-set table routes local calls to numbers that do not match entries in the local exchange tables. This table has two subpatterns of up to six routes each, but neither absorbed digits nor system-prefixed digits are used. In Release 3.1 and later systems, routes assigned to the Default Local Table are factory-set with an FRL of 2.

The system can have up to 20 tables, 16 of which are fully programmable. The Dial 0, Special Numbers (N11), Default Toll, and Default Local tables are factory-set and allow limited programming.

Each table (where appropriate) can have two subpatterns (A and B) with an associated start time. The start time for Subpattern A is specified as the stop time for Subpattern B. One subpattern or the other is selected, based on the time of day and the subpattern start time. (If both subpatterns have 00:00 start time, Subpattern A is selected.) Each subpattern can contain up to six routes, listed in order of preference or cost effectiveness.

In addition, each route has an FRL associated with it. The FRL is used to refine the route selection process further. Each extension, remote access barrier code,

and remote access default Class of Restriction (COR) is assigned an FRL from 0 through 6. Each route is also assigned an FRL from 0 through 6. For extensions, 0 is the most restrictive and 6 is the least restrictive level. For lines/trunks, 6 is the most restrictive and 0 is the least restrictive level. An extension can use a route only if its FRL is greater than or equal to the route's FRL. For Release 6.0 or later systems (Hybrid/PBX mode only), refer to the *Network Reference* for information on private network call routing.

Other digits or special characters may be required so the system can route a call on a particular pool. For example, some companies use an alternate toll call carrier that requires dialing the number with Pause characters and access codes. Each ARS route may have up to 20 characters that are automatically prefixed when a user dials a number. The allowed characters are the digits 0 through 9, *, and Pause. For Release 6.0 or later systems (Hybrid/PBX mode only), refer to the *Network Reference* for information on prepended digits for private network calls.

ARS also provides an absorb (ignore) digit capability for each route. For example, if the central office does not require a "1" before an area code, the system can be programmed to ignore that first digit. Up to 11 characters can be automatically absorbed when a user dials a number. For 10-digit toll calls, the prefix 1 *must* be dialed to signal a toll call to ARS. If the central office does not require the prefix 1 for toll calls, the digit absorption feature can be used to eliminate the prefix as the number is dialed. Initially, all 20 tables are available for the call.

Star Codes and Automatic Route Selection

In some instances, after you dial a star code (a star character followed by a 2- or 3-digit number), the central office provides a second dial tone as a prompt for the dialer to enter more digits. Usually, this second dial tone is immediate. In cases when the second dial tone is delayed, however, calls can be misrouted or system dialing restrictions can be circumvented. (For more information about using Allowed and Disallowed Lists to restrict star codes, see ["Allowed/Disallowed Lists" on page 42.](#))

In Release 3.1 and later systems, ARS processes star codes at the beginning of a dialed number and sends the digits to the central office before any other digit analysis occurs. Any programmed prepended digits are added after the star code and before the rest of the telephone number.

ARS cannot route calls that consist only of a star code with no additional digits (such as *44 for voice-activated dialing), because the user has not dialed any digits that the system can use to choose a route.

When prepended digits are used to select facilities other than regular central office lines/trunks, dialing calls with star codes using ARS can cause dropped or misrouted calls. It is recommended that ARS calls containing star codes not be used in configurations where the MERLIN LEGEND Communications System is

either behind another switch or used to select non-standard facilities. For Release 6.0 or later systems (Hybrid/PBX mode only), star codes are not sent over the network.

ARS Restrictions for VMI Ports

In Release 3.1 and later systems, any port programmed as a VMI port is programmed with a FRL of 0. If the system manager wants to allow access to the voice messaging system Outcalling feature, the FRL applies to Outcalling calls.

If the system manager changes a VMI port to a non-VMI port, the FRL is not reassigned on the port. If the default FRL should be changed, the system manager must change it through system programming.



SECURITY ALERT:

Any changes to the FRL and other restrictions of these ports must be considered carefully in order to minimize the potential for toll fraud.

How ARS Works

You hear an inside dial tone on an SA button, and you dial the ARS access code (usually a 9) to connect to ARS, then you dial a call. If the extension is restricted or toll-restricted and the number dialed is not on the Allowed List, or if the number dialed is on the Disallowed List, you receive a system error tone. Otherwise, ARS compares the number dialed with information in the tables. All tables are available for use at first. Tables are then eliminated from possible use on the call, one by one, until the best table is selected.

Once the table is selected, ARS chooses the appropriate subpattern and checks restrictions, eliminating from consideration any routes with restriction levels higher than the extension's. Any remaining eligible routes are scanned from the beginning of the list. The first eligible route that is not busy is selected.



NOTE:

In Release 6.0 and later systems, equal access calls (Interexchange or IXC calls), Dial 0 calls, and N11 calls from systems that are not connected to the public switched telephone network require special planning. See [“Tandem Switching” on page 699](#) for details.

Table Selection

411, 611, 811, 911, or 10xx/101xxxxx (Equal Access Codes)

If the caller dials one of these N11 or equal access (Interexchange or IXC) numbers, the call is routed over the main pool, using the factory-set Special Numbers (N11) Table.

Area Code Tables	Local Exchange Tables	6-Digit Tables	1+7 Tables
Dial 0 Table	Special No. (N11) Table	Default Toll Table	Default Local Table

First Digit Not a 1, N11, or Equal Access Code

All but the Local Exchange, Default Local, and Dial 0 Tables are eliminated.

Area Code Tables	Local Exchange Tables	6-Digit Tables	1+7 Tables
Dial 0 Table	Special No. (N11) Table	Default Toll Table	Default Local Table

Next, ARS examines the entries in the Local Exchange Tables:

- If ARS finds only one match, it selects that Local Exchange Table.
- If ARS finds more than one match, it selects the lowest-numbered Local Exchange Table.
- If ARS finds no match and the first digit is 0, it selects the Dial 0 Table.
- If ARS finds no match and the first digit is not 0, it chooses the Default Local Table.

First Digit a 1 (Not an Equal Access Code)

ARS eliminates the Default Local, Dial 0, Special Number, and Local Exchange Tables and proceeds as described below.

Area Code Tables	Local Exchange Tables	6-Digit Tables	1+7 Tables
Dial 0 Table	Special No. (N11) Table	Default Toll Table	Default Local Table

If only a "1" followed by seven digits have been dialed and there is one 1+7 Table that matches, it is chosen. If more than one table matches, the lowest-numbered table is chosen. If there are no 1+7 Tables that match, ARS picks the Default Toll Table.

If more than seven digits have been dialed after the 1, the 1+7 Tables are eliminated. The next three digits following the 1 are compared to the 3-digit area codes in the Area Code Tables and the first three digits of the 6-Digit Tables; any unmatching tables are eliminated. If there are no matches, the Default Toll Table is selected.

If there are matching tables, the next three digits are compared to the second through ninety-ninth entry in the remaining 6-Digit Tables. If there is only one match, that 6-Digit Table is used. If there is more than one match, the lowest 6-Digit Table is used. If there are no matches and there are no area code tables left, the Default Toll Table is selected. If there are no matches and there are Area Code Tables that have not been eliminated, one of the Area Code Tables is chosen. If there is one table left, it is used. If there is more than one table, the lowest one is used.

[Figure 1](#) is a flowchart that shows how a table is selected.

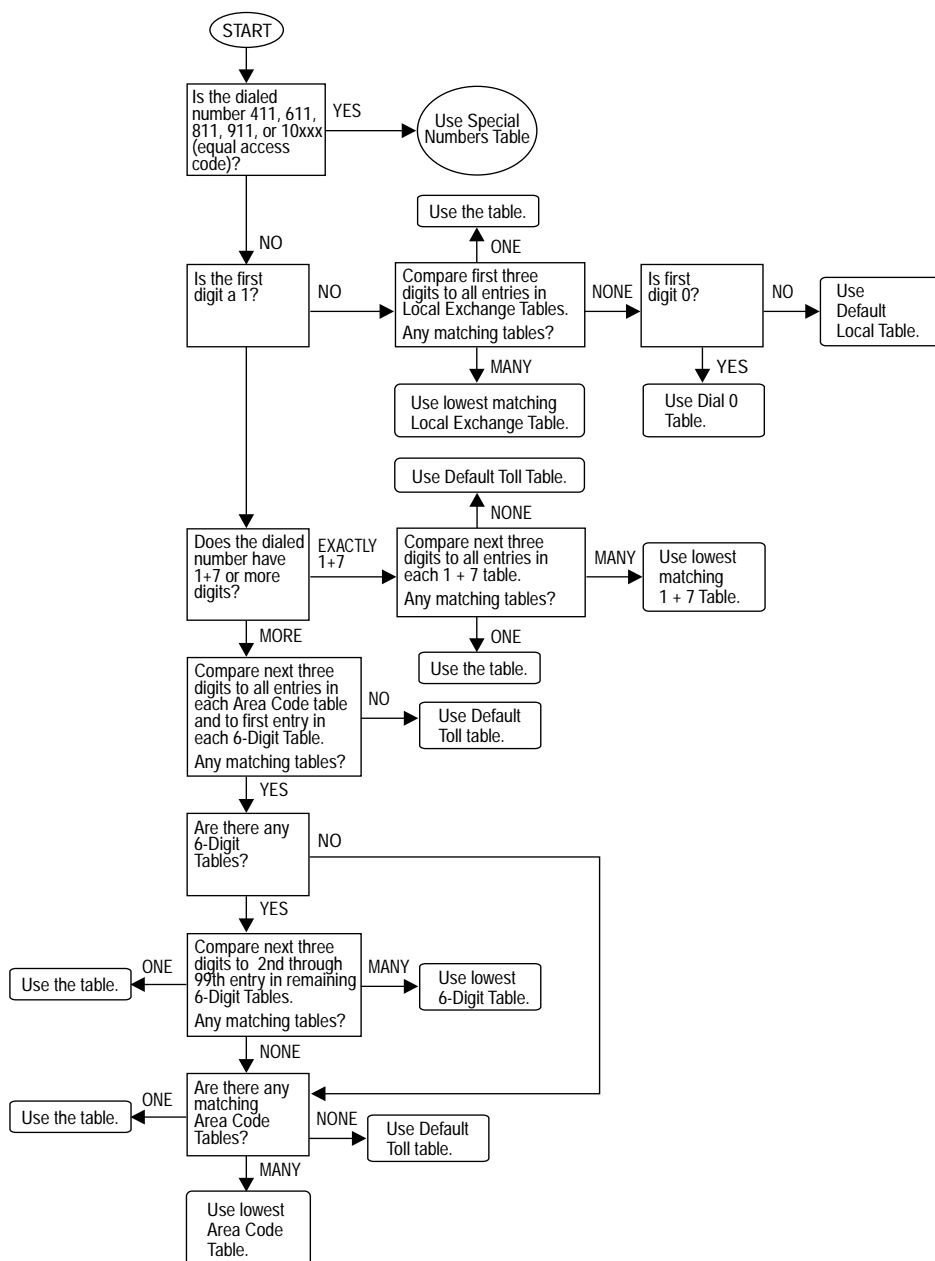

Figure 1. ARS Table Selection

Route Selection within the Table

Once the table is selected, ARS checks the subpatterns within the table (if applicable) and the restrictions on the routes (See [Figure 2](#)).

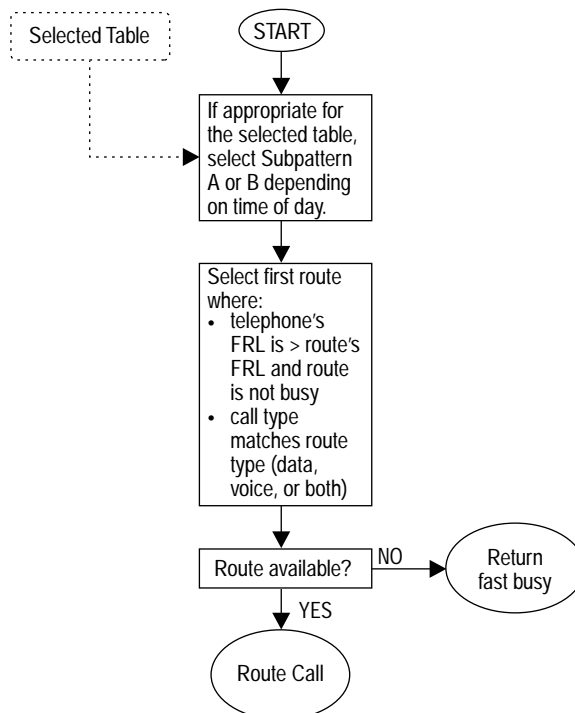

Figure 2. ARS Route Selection within a Table

Subpatterns

Depending on the time of the call, one of two subpatterns (each with up to six different routes) is chosen for each table [except the Special Numbers (N11) and Dial 0 Tables]. The time of day is compared to the start and stop times of Subpatterns A and B. (The start time for Subpattern A is the stop time for Subpattern B.) If the time of the call is between the Subpattern B start time and stop time, then Subpattern B is selected; otherwise Subpattern A is selected. If both Subpatterns have 00:00 start times, Subpattern A is selected. (See [Figure 3](#).)

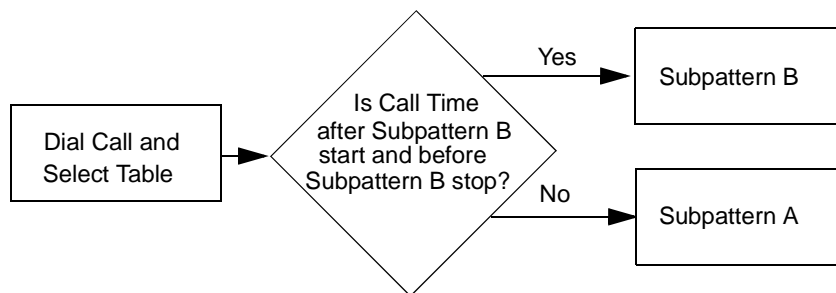

Figure 3. Subpattern Selection

Restrictions

If the FRL for an extension, for a remote access barrier code, or for the remote access default COR is equal to or greater than the FRL of any of the routes in the selected subpattern, those routes are eligible for selection. [Table 3](#) shows how FRLs are used to decide whether a route is allowed.

Table 3. Facility Restriction Levels

FRL	Route FRL	Allowed
0	0 only	Yes
0	1 and up	No
1	0 and 1	Yes
1	2 and up	No
2	0-2	Yes
2	3 and up	No
3	0-3	Yes
3	4 and up	No
4	0-4	Yes
4	5 and up	No
5	0-5	Yes
5	6	No
6	Any	Yes



NOTE:

In Release 6.0 and later systems (Hybrid/PBX mode only), FRLs associated with extension numbers apply both to ARS calls and to local and non-local dial plan-routed calls over private networked trunks, including those used to reach non-local dial plan extension numbers. See [“Tandem Switching” on page 699](#) and [“Uniform Dial Plan Features” on page 741](#) for details.

For a call, any route that does not match the call type (voice or data) is eliminated from eligibility. Each route may be specified as voice, data, or both.

If a voice call is queued for callback on a digital pool, it can get stuck in an infinite loop of queuing. The caller hears a continuous stutter tone and cannot get rid of it. To avoid this situation, be sure that you correctly program the voice and/or data capabilities of pools of PRI and BRI facilities in the ARS tables.

Any remaining eligible routes are scanned from the beginning of the list. The first eligible route that is not busy is selected. If all eligible routes are busy, the user hears a fast busy and can use Callback to queue the call *for the first route only*. In Release 6.0 and later systems (Hybrid/PBX mode only), callers who are accessing ARS over private trunks can queue for a private trunk pool on their switch, but not for a route on the remote system associated with a PSTN trunk on that system.



NOTE:

Emergency numbers must be on an Allowed List to be called from a restricted extension.

Considerations and Constraints

ARS restrictions (FRLs) operate independently of dial-access-to-pool restrictions, providing greater flexibility in assigning the type of usage an extension is allowed.

The international dialing code (011) can be included in any fully programmable table. If this is done, calls beginning with 011 are routed according to the table on which 011 is entered, and not according to the Dial 0 Table.

The wild card character (Pause) cannot be used in system programming to enter area codes and/or exchanges in ARS tables.

In Release 6.0 and later systems, a non-local system's ARS access code must not be included in the non-local dial plan. To do so would allow users to dial out of the remote networked systems, bypassing local restrictions. If you attempt to include the local system's ARS access code in the non-local dial plan, the programming is blocked. In a network, it is recommended that all systems use the

same ARS access code. For additional information, see [“Tandem Switching” on page 699](#) and [“Uniform Dial Plan Features” on page 741](#).

Calls made to the equal access code (10xxx) are always routed immediately over the main pool, whether or not they appear in other ARS tables. People who are restricted from using a particular ARS route hear a high-low error tone, indicating that the call cannot be completed.



NOTE:

In Release 6.0 and later systems, special planning is required for equal access calls (also called *IXC* or *Interexchange* calls), N11 calls, and Dial 0 calls from systems that are not connected to the public switched telephone network. See [“Tandem Switching” on page 699](#) for details.

Even if the local telephone company does not require it, callers must dial 1 before any 10-digit telephone number, so that ARS can determine whether a call is toll or local. If the 1 is not required by the local central office, the system may be programmed to ignore it.

Some central offices still require the prefix 1 for dialing certain exchanges. If the 1 + 7-Digit Dialing Requirements option is programmed as Within Area Code, the system expects either dial time-out or a # (end of dialing) to indicate whether a 1 + 7-digit or a 1 + 10-digit number has been dialed. (This may result in delays while the user waits for time-out.) To avoid time-out delays, 1 + 7-Digit Dialing Requirements can be programmed as Not Within Area Code, but all exchanges requiring a system-prefixed 1 must be listed in a local exchange table, and the 1 must be specified as a character to be prefixed. In this case, users must not dial the 1 before dialing those exchanges.

Area Codes 800 and 900 are treated as entries in programmable tables. They may be programmed either as area codes or as exchanges.

Mode Differences

ARS is available only in Hybrid/PBX mode.

Feature Interactions

Account Code Entry

When ARS is used on the system, you can enter an account code before or after dialing the telephone number.

If Forced Account Code Entry is assigned to the extension, you must enter the code before dialing the ARS dial-out code.

Allowed/ Disallowed Lists	ARS checks Allowed and Disallowed Lists before choosing the route for a call. This prevents users with restricted extensions from dialing numbers that are not on an Allowed List. ARS also prevents a user from dialing numbers on a Disallowed List.
Authorization Code	You can enter an authorization code before dialing the ARS access code. After dialing the ARS access code, you can enter an authorization code only if a Feature button or programmed Authorization Code button is used.
Auto Dial	You cannot program ARS dial-out codes on inside Auto Dial buttons. You can program an ARS dial-out code on an outside Auto Dial button.
Automatic Maintenance Busy	If you use ARS to make an outside call, the system selects another line/trunk in the pool when the first line/trunk is in maintenance-busy state.
Callback	<p>When you use ARS to make a call, and all possible line/trunk routes are busy, the call can be queued only for the first route in the pattern. If the FRL for the extension does not allow the call to be made over the route, however, the call is not queued.</p> <p>If a voice call is queued for callback on a digital line/trunk pool, it can get stuck in an infinite loop of queuing. The caller hears a continuous stutter tone and cannot get rid of it. To avoid this situation, be certain to correctly program the voice and/or data capabilities of pools of PRI and BRI facilities in the ARS tables.</p>
Calling Restrictions	ARS does not allow users to avoid calling restrictions. The system checks for outward or toll restrictions assigned to the extension before it selects the best route for making the call. If the ARS FRL assigned to the extension restricts use of the route, an error tone sounds and the call does not go through. Because FRL assignment determines pools selected for each route, a user may be allowed to select a pool using ARS even if the extension is restricted from the pool dial-out code.
Digital Data Calls	You can make data calls using ARS. To make calls using ARS, terminal adapters and video systems simply dial the ARS dial out code (usually 9) followed by the telephone number. The data calls <i>must</i> be routed through ARS pools that have only PRI, tandem PRI, NI-1 BRI, T1-emulated tandem data, and/or Switched 56 T1 data lines. To make a 2B data call, you must access two separate lines.
Direct Station Selector	The LED next to a DSS button for the ARS code is always off. For the local system only, if the local ARS access code programmed on a DSS button is pressed, the call is set up and always requires the remaining called digits to be entered manually and the transfer to be completed manually, pressing the Release button or hanging up.
Directories	System Directory and Personal Directory (MLX-20L telephones only) numbers can include the ARS dial-out code.

- Display** Only the ARS dial-out code and the dialed number are displayed. Digits added by ARS before the dialed number and digits ignored by ARS are not displayed. The digit 9 is replaced with *OUTSIDE* when ARS selects a line.
- Forward and Follow Me** When you dial the ARS code before the telephone number, ARS can select the facility on which to forward calls to an outside telephone number. The FRL for the call is that of the extension from which calls are being forwarded.
- HotLine** HotLine extensions (Release 5.0 and later systems) can use the ARS access code if it is programmed into their Personal Speed Dial number.
- Night Service** When Night Service with Outward Restriction is programmed, you must enter the password before dialing the ARS dial-out code, unless either the extension is assigned to an Exclusion List or the number is on the Night Service Emergency Numbers List.
- Pools** ARS ensures appropriate and cost-effective use of pools. ARS and the dial-access-to-pools restriction function independently of each other. If ARS restrictions are programmed to allow access to a pool, a user may seize a pool that the extension is not allowed to use under existing pool dial-access restrictions.
- Primary Rate Interface and T1** In Release 6.0 and later systems, ARS can be set up so that callers on one networked system can use PRI tandem trunks or tandem tie trunks to reach a remote system and make calls from lines/trunks that are connected to that remote system. This can often result in cost savings. The remote callers dial normally; remote access is invoked transparently, and barrier codes are not required.
- In releases prior to 6.0, an incoming call can access ARS only through explicit Remote Access procedures, transferring, or Remote Call Forwarding through ARS. A PRI line can be a member of a pool accessed through ARS. Before ARS routes a call to a pool, it checks whether one or more member lines in that pool are available. If not, it selects an alternative pool so that the call is not blocked. Even if a B-channel is available when ARS selects a pool with an available line, there may be none available when it is time to send a setup message to the network, or, after the setup message is sent, the network may determine that the B-channel proposed by the system is not available. In either case, the call fails and fast busy tone is heard.
- Recall/Timed Flash** In Release 2.0 and later systems, Recall can be used on an ARS call. Recall cannot be used during dialing. When dialing is complete, pressing the Recall button sends a timed flash to the host, the accessed line is kept, the user hears outside dial tone, and calling restrictions are reapplied.
- In Release 1.0 and 1.1 systems, Recall cannot be used on an ARS call because the call is made on an SA button.

Remote Access	<p>Remote access users can make calls by using ARS. They dial into the system, enter a barrier code if one is required, and dial the ARS code while listening to system dial tone. FRLs can be assigned to restrict the routes that remote callers can use. When barrier codes are not used, an FRL is assigned to all lines/trunks (tie trunks and non-tie trunks are grouped separately) and cannot be assigned to individual lines/trunks. When barrier codes are used, FRLs are assigned to individual barrier codes.</p> <p>The steps above are not used by networked non-local users making ARS calls into your system, even though your system treats these calls as remote access calls. Instead, a caller dials the ARS call just as they would any other ARS call.</p>
Saved Number Dial	<p>The ARS dial-out code is saved with the telephone number dialed.</p>
Service Observing	<p>In Release 6.1 and later systems, calls made by using ARS can be observed when end-of-dialing is reached.</p>
Speed Dial	<p>Personal Speed Dial and System Speed Dial numbers can include the ARS code.</p>
SMDR	<p>SMDR reports for systems with ARS show all the digits dialed by a user in the CALLED NUMBER field, including any absorbed (ignored) digits, and the facility used to make the call. The reports do not include the ARS dial-out code or any digits added by ARS.</p>
System Access/ Intercom Buttons	<p>The ARS FRL assigned to the extension being used to make the call applies to calls made on both SA and Shared SA buttons.</p>
System Renumbering	<p>The ARS access code can be renumbered. (The factory setting is 9.)</p>
Tandem Switching	<p>In Release 6.0 and later systems (Hybrid/PBX mode only), the ARS access code is accepted over private networked trunks, allowing users in a local system to make calls from lines/trunks connected to a remote system. The system manager programs ARS in order to direct calls over the most cost-effective routes; calls that are local, for example, at a remote networked switch, can be sent out from lines/trunks connected to that system. At the remote system, Remote Access features are used to accept such a call.</p> <p>Do not program a remote system's ARS access code into the local system's non-local dial plan. For example, if the ARS access code is 9, do not include a range of extensions that begins with 9. If you attempt to program the local ARS access code into the non-local dial plan, the system blocks the attempt. For security and convenience, it is best if all systems in a network use the same ARS access code.</p>

Features

Automatic Route Selection

94

Tandem Switching
(continued)

Because equal access (IXC or Interexchange) calls from a system with no PSTN trunks require that local and remote ARS access codes match, the local ARS access code is automatically prefixed when these calls are sent to a networked system. You should not use this arrangement unless networked systems are co-located. Otherwise, Dial 0 and Special Number calls (911 calls, for example) do not reach the correct local services.

Toll Type

In certain areas, the local telephone company requires the prefix 1 for certain exchanges. In these cases, the exchanges can be assigned to a 1 + 7 table; 1 + 7 dialing requirements must be set to Within Area Code so that people calling numbers in other exchanges do not have to dial 1.

Barge-In

At a Glance

Users Affected	Telephone users, operators
Reports Affected	Extension Information
Modes	All
Telephones	All except single-line telephones
Programming Code	*58 (centralized telephone programming only)
QCC Display Label	Barge In

Description

Barge-In allows a caller to contact a co-worker in an emergency or when the caller has been given special instructions to interrupt. If the extension is busy, Barge-In includes the user in the call. If Do Not Disturb is activated, Barge-In overrides the feature and makes the telephone ring.

On multiline telephones, except QCCs, the caller interrupts a call or overrides Do Not Disturb by calling the extension number and then pressing the programmed Barge-In button. On a QCC, an operator presses the Feature button and selects *Barge In* from the display.

A tone, heard by the user and the people on the call, signals that the user has joined a conversation in progress. Ringing indicates that Do Not Disturb is on at the extension.

Barge-In is similar to the Service Observing feature in that both features gain access to a call already in progress. The person barging in, however, can talk to the other parties on the call; the Service Observer can only listen in on the call.

Considerations and Constraints

Barge-In does not override Privacy.

If Caller A is in the process of dialing and Caller B uses Barge-In to reach Caller A, the touch tones generated by dialing cancel the Barge-In tone. As a result, Caller A may not be aware that someone else is joining the call.

If a caller presses the Barge-In button while calling an MLX telephone, an extra ring occurs on the MLX telephone. A Barge-In button can be programmed only through centralized telephone programming.

Telephone Differences

Direct-Line Consoles

If a DLC operator uses Barge-In to reach someone with Coverage or Forwarding (including Remote Call Forwarding) on, the call from the operator is not directed to the destination (receiver's) extension. The call is directed to the extension on which Barge-In is used.

Queued Call Consoles

A QCC operator can use Barge-In only by selecting the feature from the display. Barge-In can be used to join an inside call to a QCC operator only if the user dials the *caller's* extension instead of the QCC operator's number. If a user tries to activate Barge-In after dialing a QCC system operator's extension and waiting in the QCC queue, the feature has no effect and the user hears an error tone. If the error tone times out while the call is still in the QCC queue, the call is disconnected. If a QCC system operator becomes available before the error tone times out, however, the error tone is removed and the call is delivered to the operator normally.

Single-Line Telephones

Single-line telephone users cannot use Barge-In, however, other telephone users can use Barge-In to interrupt or monitor calls on single-line telephones.

Feature Interactions

Basic Rate Interface	Barge-In can be used for voice calls on a BRI line, but not for BRI data calls.
Callback	If Callback is used to request a busy extension or pool and the user is waiting on the line for the callback call, Barge-In cannot interrupt.
Conference	Barge-In can interrupt conference calls; all participants hear the Barge-In tone. Barge-In does not connect the user to a conference call if the conference already has the maximum number of participants. If Barge-In is used to connect to a conference call that involves an outside line/trunk and the person on the outside line/trunk hangs up, the person using Barge-In is also dropped.
Coverage	Barge-In can be used for Individual or Group Coverage calls answered at any receiver's extension, but not at a VMI port. VMI ports always have Privacy on. If an operator uses Barge-In to reach an extension with Coverage, however, the call from the operator is not directed to the receiver's extension.
Digital Data Calls	You cannot barge into data calls.

Direct Station Selector	After making a call to an extension by using a DSS button on a DLC, you can activate Barge-In by pressing a programmed Barge-In button. QCC operators select the feature from the display.
Display	When you are using an MLX telephone, you see a message when using Barge-In. If Barge-In is denied, no message appears. See Table 18 on page 273 . The extension receiving the call also sees a message indicating who barged in. The message remains on the display until the person hangs up.
Do Not Disturb	If Do Not Disturb is activated, Barge-In overrides the feature and makes the telephone ring.
Forward and Follow Me	If an operator uses Barge-In to call an extension with Forwarding or Remote Call Forwarding turned on, the call from the operator is not directed to the destination extension. When a forwarded call is answered at the destination extension, Barge-In can be used to join the call only by dialing the extension number for the destination extension (not the number for the originating extension). Barge-In cannot be used to join a call forwarded to an outside telephone number.
Group Calling	Barge-In can be used for calling group members, but the member's extension must be used instead of the calling group extension. If you try to use Barge-In after dialing the calling group extension number and waiting in the queue, the feature has no effect. If you use Barge-In to reach another user who is waiting in a calling group queue, the call is removed from the queue, and both of you are connected to the delay announcement (if programmed). If you use Barge-In for the delay announcement extension and the device is playing a message to a caller, the call is removed from the queue, and both of you are connected to the delay announcement. In Release 5.0 and later systems when the Most Idle agent hunt type is used, if a supervisor or operator barges in on a calling group call and hangs up before the agent does, Most Idle status is not affected. If the agent hangs up first, he or she moves to the end of the Most Idle queue.
Headset Options	If you use Barge-In to contact a user with Headset Auto Answer turned on, the call is automatically answered.
HotLine	Barge-In can be used for HotLine (Release 5.0 and later systems) calls.
Messaging	If Barge-In is used to contact a user with a posted message, the caller's telephone does not display the posted message.
Paging	Barge-In cannot be used to join speakerphone or loudspeaker paging calls.

Privacy	<p>Barge-In does not override Privacy. The caller hears a busy signal.</p> <p>All VMI ports always have Privacy on. Barge-In cannot be used to join calls to VMI ports.</p>
Recall/Timed Flash	<p>In Release 2.0 and later systems, you can use Recall if you have joined a call with Barge-In, and so can the user who has been interrupted.</p> <p>In Release 1.0 and 1.1 systems, you cannot use Recall with Barge-In, because Barge-In requires an SA or ICOM button.</p>
Service Observing	<p>In Release 6.1 and later systems, Service Observers can observe external calls that have been barged-in by internal users, either at the barged-in extension or at the extension that has barged-in.</p>
UDP Features	<p>In Release 6.0 and later systems (Hybrid/PBX mode only), you cannot use Barge-In for calls over a private network.</p>

Basic Rate Interface (BRI)

At a Glance

Users Affected	Telephone users, operators, digital data users
Reports Affected	System Information (<code>SysSet-up</code>), BRI Information
Modes	Key, Hybrid/PBX
Telephones	All Calling Party Number appears on the MLX, ETR, and MLS display telephones. Called Party Number appears on the MLX and ETR display telephones.
System Programming 800 NI-BRI Module	Specify 800 NI-BRI modules that provide primary, secondary, and tertiary clock synchronization and source-of-clock synchronization; also activate/deactivate clock: <ul style="list-style-type: none"> ■ <code>LinesTrunks→More→ClockSync</code> ■ Assign telephone numbers (SPID and DN) to BRI lines: ■ <code>LinesTrunks→More→BRI→SPID/DN→SPID→Enter→DN→Enter</code> Specify BRI timer settings: <ul style="list-style-type: none"> ■ <code>LinesTrunks→More→BRI→Timers</code>
Maximums	
BRI modules	5
Factory Settings	
Systemwide Clock Synchronization Source	Loop (not definable by system manager)
Primary Clock	First port in service on an 800 NI-BRI module, or first 100D module in service in control unit
Clock BRI	Active
Service Profile Identifier (SPID) assigned to BRI line	0 digits
Directory Number (DN) assigned to BRI line	0 digits
Timer and counter thresholds for all BRI ports in system	
T200 Timer	1,000 ms (range 500–5,000 ms, increments of 500 ms)
T203 Timer	33 seconds (range 10–255 seconds, increments of 1 second)
T303 Timer	4 seconds (range 2–10, increments of 1 second)
T305 Timer	30 seconds (range 2–60, increments of 1 second)
T308 Timer	4 seconds (range 2–10, increments of 1 second)

Description

BRI, like PRI, is a standard protocol for accessing Integrated Services Digital Network (ISDN) services. By using BRI, the MERLIN LEGEND Communications System can connect its users to the speed and accuracy of ISDN services. National ISDN-1 (NI-1) BRI service is available for MERLIN LEGEND Communications System Release 4.0 and later systems only.

BRI lines offer the capability of voice, high-speed data, local area network (LAN) interconnection, and video transmission. BRI lines (along with PRI and T1 Switched 56) also allow you to take advantage of the 2B Data feature for videoconferencing systems with ISDN-BRI interfaces. The 2B Data feature allows one application (such as a desktop video system or a high-speed digital communications device) to use two B-channels for data transfer rates up to 128 kbps. For more information, see [“Digital Data Calls” on page 223](#).

The following benefits are provided by NI-1 BRI service:

- **Speed.** Data calls to outside destinations can be established on the same B-channels used for voice calls if the service allows; modems and dedicated, conditioned lines/trunks are not needed. By supporting high-speed digital data transmission, BRI provides the capability for videoconferencing and Group IV (G4) fax by using existing wiring. Each B-channel supports up to 64 kbps throughput.
- **Improved Toll Restriction.** The ways that toll restriction can be bypassed are limited on BRI lines/trunks. Specifically, BRI service eliminates three types of toll fraud:
 - Because dialing is in the form of out-of-band messages that must be generated by the system, a person cannot use a touch-tone generating device, such as a pocket dialer, to send dialed digits directly through the system to the line/trunk.
 - Without BRI service, toll restriction can be deceived by dialing digits on a loop-start line before the far-end switch applies dial tone. These initial digits may indicate a local call to the system's toll-restriction checking while the subsequent digits, those actually recognized by the far-end switch, may produce a toll call. This is not possible with BRI service, because the system's toll-restriction check screens every dialed digit.
 - A BRI line's far-end disconnect signal provides a reliable indication when a call ends, and a new call cannot be initiated until the line has been released from the prior call on both ends. This prevents a person, waiting off-hook for the restoration of dial tone after a previous call, from placing a second call before toll restriction is reapplied.

- **Reliable Indication of Far-End Disconnect.** This prevents an incoming call from being blocked because a line/trunk has not been released when a call is ended.

Terminology

Lines/Trunks

In this section on BRI, *lines* are the representations that appear on extensions or are put into pools; *trunks* are the facilities that link switches. For all trunks except DS1 (T1 or PRI) and BRI, inside line numbers have a one-to-one correspondence to line/trunk jacks. Because there are two transmission channels, or bearer channels (called *B-channels*), for each BRI connection, two inside line numbers are assigned for each BRI port. B-channels are present for each Digital Subscriber Line (DSL); therefore, 16 inside lines are assigned for each module used.

A B-channel is used to carry user information, such as the voice or data content of a call, between the system and the far-end switch.

Digital Subscriber Line

Digital Subscriber Line (DSL) refers to the facility from the central office that supports BRI service. A Digital Subscriber Line provides full-duplex service on a single twisted-pair wire (2-wire) at a rate sufficient to support ISDN Basic Rate Access.

Directory Number

In general, the Directory Number (DN) is the telephone number that is dialed to reach a destination. When an incoming call arrives on a BRI line, the central office presents the DN as the Called Party Number. Only one call to a particular DN is accepted at any one time. The DN is usually a subset of the Service Profile Identifier (SPID). Only the DNs for the hunt group are unrelated to the SPIDs.

ISDN Ordering Code

The ISDN Ordering Code (IOC) is defined by Bellcore as part of the National ISDN Package. The IOC defines a number of capabilities for the BRI connection, which are aimed at different user applications. The MERLIN LEGEND Communications System supports the IOC capability package S. IOC package S supports circuit-switched voice and data calls over both B-channels with a Calling Party Number identifier.

Multiline Hunt Group

A multiline hunt group can be programmed at the central office to send calls to a number of separate DNs that are grouped together.

A multiline hunt group consists of a group of BRI lines with one main telephone number (Directory Number). When this number is dialed by an outside caller, the central office tries to deliver the call to one of the BRI lines in the hunt group. If the BRI line is busy, the central office directs the call to the next available idle line.

In order to know the available options of Multiline Hunt Group and to set it up correctly, you must find out what type of switch your central office uses.

For the different switches, Multiline Hunt Group has the following capabilities:

- **5ESS®**. Multiline Hunt is available for voice-only and digital data-only applications. Multiline Hunt capability is provided under a switch feature called *Series Completion*. Do not use the 5ESS feature named *Multiline Hunt Group*. For alternate voice and digital data applications, special central office features (such as call forwarding) are also required in the line provisioning. As a result, this configuration may not be supported by some of the Regional Bell Operating Companies (RBOCs) or other local carriers.
- **DMS-100**. Multiline Hunt is available for voice-only, digital data-only, and alternate voice and digital data applications.
- **EWSD**. Multiline Hunt capability is provided under a switch feature called *Series Completion*. It is limited to six DSLs in a group, however, and may not be supported by some central offices. Do not use the EWSD feature named *Multiline Hunt Group*. Multiline Hunt is available for voice-only and digital data-only applications. Alternate voice and digital data applications are not supported.

**NOTE:**

Multiline Hunt is not part of IOC package S. If Multiline Hunt is needed, you must order the appropriate feature and inform the central office of the switch settings that you need (see Appendix H of *System Planning*).

Called Party Number

In general, the term *Called Party Number* (CdPN) denotes a telephone number that has been dialed to reach a destination. While routing the call, however, the network can change the Called Party Number to make routing easier. In either case, the network sends the Called Party Number to the system when a call arrives at the system. Depending on the type of call, the called party number may be displayed on the second page of the MLX or ETR telephone display.

**NOTE:**

Analog multiline and MLS telephones do not display Called Party Number information.

Calling Party Number

The *Calling Party Number* (CPN) provides incoming calling party number information that identifies the originator of a call in the call-handling displays of MLX, ETR, or MLS telephones. If the owner of the MERLIN LEGEND Communications System subscribes to this BRI feature, each incoming call to the system over a BRI line can be accompanied by the CPN or by the billing number of the calling party supplied by the network.

⇒ NOTES:

- If the calling party subscribes to the central office Directory Number Privacy feature, no number is received.
- Analog multiline telephones do not display Calling Party Number information.
- Calling Party Number on BRI lines is *not* the same as Calling Party Number in Caller ID. Caller ID occurs on loop-start lines.

Service Profile

A *Service Profile* (SP) defines the interface on a BRI line between the central office and an ISDN terminal. It specifies the parameters and their values necessary to provide services to the terminal.

Service Profile Identifier

A *Service Profile Identifier* (SPID) is a unique identifier used by the central office to associate an ISDN terminal with a Service Profile. It is provided by the central office at subscription time. The system manager must program the SPID for each BRI line to bring the BRI line into service (activate). If dial tone is received, then the correct SPID has been programmed.

Clock Synchronization

Clock synchronization is an arrangement where digital facilities operate from a common clock. Whenever digital signals are transmitted over a communications path, the receiving end must be synchronized with the transmitting end in order to receive the digital signals without errors.

The system synchronizes itself by extracting the timing signal from the incoming digital stream. If the system has one 100D module, that module provides its own primary synchronization. If the system has at least one 800 NI-BRI module, more than one 100D module, or a combination of 100D modules and 800 NI-BRI modules, then one of the connections provides primary clock synchronization for all 800 NI-BRI and 100D module ports and for the system's *time-division multiplexing* (TDM) bus. The primary clock synchronization source must be identified during system programming. The factory setting is the first 100D module

in service or the first port in service on the first 800 NI-BRI module in the carrier. This can be changed through system programming.

In the event of a maintenance failure of primary synchronization, backup synchronization can be provided by secondary and tertiary clock synchronization.

In addition, the source of synchronization is factory-set to Loop Clock Reference Source, so that the clock is synchronized to the outside source. With a 100D module, it can be set to Local Clock Reference Source so that the clock is free-running. However, this is not recommended for most permanent installations and systems with PRI. This setting must be made for the primary, secondary, and tertiary synchronization sources.

On a frigid start (System Erase), the first 100D or BRI port in service is the default primary loop clock source.

The following lists the options for primary, secondary, and tertiary clock synchronization sources in order of preference:

1. The clock sources on BRI ports with DSLs in service. If at all possible, all three clock sources should be on the same 800 NI-BRI module.
2. The loop clock source on any 100D module.
3. The loop clock source on any 100D module in T1 mode emulating tie trunks.
4. The local clock source on any 100D module.



NOTE:

Ports that are not in service should never be programmed as clock sources.

Clock Switching

When the primary clock source is not able to provide the system clock, the secondary clock source is used, if it exists and is capable of providing the system clock. If the secondary clock source is incapable of providing the system clock, the tertiary clock source is used. If none of these is capable of providing the system clock, the communications system selects a system clock.

The system searches 800 NI-BRI and 100D modules for a clock source, starting from the first module in the system and ending with the last module. The clock is chosen with the following order of preference:

1. Loop clock source on an 800 NI-BRI or 100D module
2. Local clock source on an 800 NI-BRI or 100D module
3. Local clock source on the processor module

For Release 6.0 and later systems (Hybrid/PBX mode only), refer to the *Network Reference* for information on clock switching for private networks.

Timers and Counters

This option sets the timer and counter thresholds. The factory settings for thresholds are standard and rarely need to be changed. (See “At a Glance” in this section for factory settings and valid ranges.) When no response is received from the network before the duration of the timer setting, the communications system takes the appropriate corrective action.

The programmable timers and counters are as follows:

- **T200 Timer.** Times the minimum time that the link layer waits for an acknowledgment of link establishment, information, or polling supervisory frames sent from the communications system to the network before resending the frames.
- **T203 Timer.** Maximum time that the link layer can remain inactive.
- **T303 Timer.** Times the delay in network response when the communications system sends a setup message to initiate an outgoing call.
- **T305 Timer.** Times the delay in network response when the communications system sends a disconnect message to clear a call.
- **T308 Timer.** Times the delay in network response when the communications system sends a release message to clear a call.

Other timers and counters used by the system are not programmable:

- **N200 Counter.** Counts the number of times the communications system can transmit a message on a D-channel because no link layer acknowledgment is received from the network. The value for this counter is 3.
- **N201 Counter.** Counts the maximum number of Layer 3 bytes the system can send or receive in a single D-channel message. The value for this counter is 260.
- **N202 Counter.** Counts the maximum number of times that Layer 2 should retransmit TEI-REQUEST frames before notifying Layer 3. The value of this counter is 3.
- **K Counter.** Counts the number of Layer 3 unacknowledged messages sent from the communications system to the network on a D-channel. The value for this counter is 1.
- **T202 Timer.** Minimum time Layer 2 must wait for an acknowledgment of a TEI-REQUEST frame before initiating retransmission. The value of this timer is 2 seconds.

- **T309 Timer.** Times the duration of a D-channel data link failure (a loss of signaling for the entire BRI connection). The value of this timer is 90 seconds.
- **T310 Timer.** Times the network delay following the receipt of a call-preceding message on an outgoing call. The value of this timer is 60 seconds.
- **T313 Timer.** Times the delay in network response when the communications system sends a connect message that indicates the completion of an incoming call. The value of this timer is 4 seconds.

**CAUTION:**

After initial installation, these timers rarely, if ever, should be changed.

Call Processing

An explanation of incoming and outgoing call processing follows.

Incoming Calls

BRI calls can be received on personal line or Pool buttons, or by calling groups or the QCC Queue. Incoming calls on BRI lines appear to a user just like calls on other types of lines.

Display Operation. The display provides call-related information about incoming BRI calls, if available. If calling party information is available and the receiving telephone is an MLX, ETR, or MLS telephone, the information is displayed on the telephone. Called party information is usually displayed on the second screen of the MLX and ETR displays.

Hyphens are inserted between the digits of the Calling Party Number for incoming calls—for example, 555-1234 for a 7-digit display and 123-555-1234 for a 10-digit display. Any other number of digits appears without hyphens.

A brief description of the display support provided in Release 4.0 and later systems follows. Refer to [“Display” on page 271](#) for additional details.

**NOTE:**

BRI display support for Release 4.0 and later systems applies to MLX and ETR (Release 7.0 and later systems) display telephones. MLS telephones can display Calling Party Number information, but not Called Party Number information. There is no BRI-specific display support for analog multiline telephones.

- **Incoming BRI Calls (Non-Group Calling).** When the calling party information is available from the network, the Calling Party Number (CPN) appears on the user's display. Pressing the More button shows the Called Party Number on the second screen of the display. (Called Party Number does not appear on MLS telephones.) If the Called Party Number is more than 15 characters in length, the digits at the end are dropped.
- **Group Calling.** The MLX or ETR display telephone of a calling group member shows the original Called Party Number. Pressing the More button shows the Calling Party Number on the second screen of the display.
- **Transfer without Consultation.** In Release 4.0 and later systems, pressing the More button on an MLX or ETR (Release 7.0 and later systems) display telephone that is a transfer destination shows the original Called Party Number.

Outgoing Calls

Outgoing calls on BRI lines can be made using one of three methods:

- **Personal Line.** When an idle personal line that represents a BRI line is accessed, the communications system sets up a call to establish a connection to the central office. The status light turns green, and dial tone is provided by the central office. As digits are dialed, they are transmitted to and processed by the central office.
- **Pool Button.** Like any other type of line/trunk, a BRI line can be accessed via a Pool button, or by using an SA button and dialing a pool access code.
- **Automatic Route Selection.** Like any other type of line/trunk, a BRI line can be accessed by using an SA button and dialing the ARS access code. ARS processing may modify the dialed number through standard digit deletion and addition. ARS can also take advantage of the distinction between voice and data calls for routing purposes when making outbound calls over BRI lines. For example, if data is frequently sent to a particular number in another area of the country, ARS can route calls to that number over high-speed data lines.

Considerations and Constraints

Because the 391A, 391A1, and 391A2 power supplies have limited capacity, when one of these power supplies is used, the total number of 800 NI-BRI modules and 100D modules in a single carrier cannot exceed three. When using these power supplies with more than three modules, you must install the fourth 800 NI-BRI module and any additional 800 NI-BRI or 100D modules in an expansion carrier. The 391A3, and 391C1 power supplies eliminate this restriction.

A Directory Number (DN) is busy when no extension is available to answer or cover the call. An extension may be unavailable when one of the following

conditions applies: no SA button (aside from Originate Only buttons) is available; Do Not Disturb is activated; the extension is being programmed; the extension is forced idle; or, the extension alarm clock is being set. The caller hears a busy tone, or the call receives coverage, if programmed.

For BRI lines, the SMDR format should be set to ISDN format.

In Release 4.1 and prior systems, an SMDR record is not recorded for a BRI facility call that is shorter than the programmed SMDR call length. Usually, the SMDR call length is programmed to compensate for connection and ringing time of calls on non-ISDN facilities before they are answered. In systems where most lines are ISDN lines, the call length should be programmed for one (1) second.

In Release 4.2 and later systems with the SMDR Talk Time option enabled, call timing for incoming calls to Auto Logout or Auto Logout calling groups begins when the system detects the call.

Feature Interactions

Account Code Entry	<p>At an extension assigned to a BRI line, you must enter an account code either before the call is made or during the call. You must enter forced account codes before the call is made.</p> <p>If the SMDR feature is not enabled to record incoming calls, the system does not accept Account Code Entry information for incoming calls.</p>
Barge-In	<p>Barge-In can be used for voice calls on a BRI line, but not data calls.</p>
Call Waiting	<p>Call Waiting is provided on BRI lines at extensions so programmed. The call-waiting tone is not blocked from BRI at an extension.</p>
Conference	<p>Calls on BRI lines can be part of a conference call processed by the MERLIN LEGEND Communications System, not by the central office. The MERLIN LEGEND Communications System determines the number of active parties on the call.</p> <p>The system supports up to five people on a conference: two within the system, two outside the system, and the call originator.</p> <p>If a MERLIN LEGEND Communications System user is part of a conference established by an outside party through the central office conference feature, the system may play Music-On-Hold (if so programmed) when the user puts the call on hold.</p>
Hold	<p>An active call on a BRI line can be placed on hold by using the system Hold feature. All call appearances (such as LEDs) are the same as for other non-BRI lines.</p>
Recall	<p>Recall is not recognized by the central office on BRI lines; therefore, the central office ignores the telephone's Recall button signal.</p>

Features

Basic Rate Interface (BRI)

109

Remote Access

A BRI line can be used for remote access.

SMDR

The number of a BRI line is shown in the LINE field of the SMDR report.

Outgoing call timing begins when a call is answered; therefore, calls that are not answered at the far end are not reported.

In Release 4.1 and prior systems, call timing for incoming calls begins when the call is answered. In Release 4.2 and later systems with the Talk Time option enabled, timing for incoming calls to Auto Login or Auto Logout calling groups begins when the system detects the call.

Transfer

Calls on BRI lines are available for the system Transfer feature. The central office-based transfer feature is not supported by the MERLIN LEGEND Communications System.

Call Waiting

At a Glance

Users Affected	Telephone users, DLC operators
Reports Affected	Extension Information
Modes	All
Telephones	All except QCC
Programming Codes	
On	*11
Off	**11
Feature Code	87 (for call-waiting pickup)
MLX Display Labels	CallWaiting,On [CWait,On] CallWaiting,Off [CWait,Off]
Factory Setting	Off

Description

When an extension is programmed with Call Waiting, you hear a tone when you are off-hook and another call arrives. For an inside call, you hear one beep; for an outside call, you hear two beeps. With an MLX display telephone, you also see `CallWaiting` on the display. The caller hears a special ringback to indicate that the extension is busy and that the call-waiting tone has been sent.



NOTE:

The Call Waiting feature is supplied by the MERLIN LEGEND Communications System and is *not* the same as the Call Waiting supplied by the central office.

A multiline telephone is considered busy when no SA or ICOM buttons are available for incoming calls and, if Coverage is programmed, all coverage points are busy.

When the called party frees an SA or ICOM button and there is a call waiting, the caller hears dequeuing tone, and the waiting call appears on the free SA or ICOM button of the called party.

A single-line telephone is considered busy when a call rings on the telephone or the user lifts the handset and, if Coverage is programmed, all coverage points are busy.

Each extension can be programmed with Call Waiting on or off. The default is Call Waiting off.

The user hears a call-waiting tone for the following types of calls that ring on an SA or ICOM button:

- An inside call
- A call received on a DID trunk
- A call from a remote access user
- A call received on an automatic dial-in tie trunk
- A call transferred to the extension



NOTE:

You do not hear a call-waiting tone for a call received on a personal line unless your business subscribes to a call-waiting service from the local telephone company.

The person receiving the call-waiting tone has these options:

- Ignore the new call and continue with the current call; the caller continues to hear the special ringback.
- Complete the current call, hang up, and answer the waiting call when it rings; the caller hears normal ringback.
- On a multiline telephone, put the current call on hold and answer the new call using an ICOM Originate Only or SA Originate Only button (if one is available) by using call-waiting pickup. To activate call-waiting pickup on an ICOM Originate Only or SA Originate Only button, press the Feature button followed by 87, or dial #87.
- On a single-line telephone without positive disconnect, put the current call on hold by pressing and releasing the switchhook or the Flash or Recall button. If the single-line telephone has positive disconnect, park the call by pressing the Flash or Recall button, then dialing your extension number. Dial #87 to answer the waiting call. To pick up a parked call, lift the handset and (while listening to inside dial tone) dial #9 plus your extension number.

Considerations and Constraints

A user can have more than one call waiting. If there is more than one call waiting, then a user who activates call-waiting pickup answers the individual calls on a first-come, first-served basis.

Call Waiting is not activated if a line button of the appropriate type (such as ICOM or SA) is available to receive a call.

An extension programmed as a fax extension can activate Call Waiting so that callers can wait until a fax machine is available. To prevent disruption of a fax message in progress, a call-waiting tone is not sent to a fax extension.

If Call Waiting is on and you are in the process of dialing when you receive a call, the touch tones generated while dialing cancel the call-waiting tone. As a result, you may not be aware that a call is waiting.

Telephone Differences

Queued Call Consoles

Call Waiting cannot be used on QCCs; the calls are already queued. The operator releases a call to a busy extension either by selecting **Camp On** from the display or by pressing the **Release** button. If **Camp-On** is used, the call does not return to the QCC queue until the **Camp-On** return interval expires. If the operator presses the **Release** button, the extension being called receives the call-waiting tone (not **Camp-On**), and the call returns to the QCC queue when the transfer return interval expires.

If the system is programmed for Automatic Extended Call Completion, a QCC operator must press the **Start** button to use **Camp-On**, then dial the extension manually, activate **Camp-On**, and press **Release**. If the operator presses a **DSS** button, the transfer is automatically completed and **Camp-On** cannot be used.

Other Multiline Telephones

If a multiline telephone does not have an **SA Originate Only** or **ICOM Originate Only** button assigned or available, you cannot pick up the waiting call. To pick up the call, you must press an available **SA Originate Only** or **ICOM Originate Only** button, press the **Feature** button, and dial 87.

If you use either **Transfer** or **Camp-On** to transfer a call to a busy extension, the call is placed in the call-waiting queue and you hear the call-waiting tone, whether or not the extension has the **Call Waiting** feature activated.

Single-Line Telephones

After picking up a waiting call on a single-line telephone, if you press and release the **Recall** or **Flash** button—or on a telephone without positive disconnect, if you press and release the **switchhook**—the picked-up call is disconnected and you are reconnected to the original call. If you hang up after picking up a waiting call, the picked-up call is disconnected and transfer is initiated for the first call; the original call goes on hold and transfer return applies.

Feature Interactions

- Basic Rate Interface** Call Waiting is provided on BRI lines at extensions so programmed. The call-waiting tone at an extension is not blocked by the BRI lines.
- Callback** When Automatic Callback is used to queue a call at an extension that has Call Waiting, Callback overrides Call Waiting. The user with Call Waiting does not hear the call-waiting tone, and the call is queued until the extension becomes available.
- When Selective Callback is used to queue a call at an extension that has Call Waiting, the user with Call Waiting hears the call-waiting tone and the call is queued until the extension becomes available.
- Caller ID** If you have both the system feature Call Waiting and the central-office service Caller ID on the same line, the Call Waiting information appears on the display, but not the Caller ID information for this second incoming call, even if you subscribe to Caller ID from the central office.
- Camp-On** If there are no available buttons to receive a transferred call, you hear the call-waiting tone when a co-worker uses Camp-On to transfer a call, even if Call Waiting is not activated.
- Conference** A call-waiting tone is heard only by the person receiving the call and not by other conference participants. If the conference originator reaches a busy extension, hears the call-waiting special ringback, and tries to add the call to the conference, the system returns a busy tone. To drop the busy tone from the conference, the originator presses the Drop button and then the line button used to call the busy extension.
- Coverage** A call to a sender with Call Waiting activated goes to Individual and/or Group Coverage first. If all coverage points are busy, the sender hears the call-waiting tone.
- Changing the status of Coverage On/Off to on after hearing the call-waiting tone does not force the waiting call to coverage receivers, but sends subsequent calls to coverage.
- Digital Data Calls** Call Waiting does not work for data calls. The call appears to wait but does not return to the extension when it becomes available. This feature should be disabled at video systems and data extensions.

Direct-Line Console	When a DLC operator uses Camp-On to transfer a call to a busy extension, the call is placed in the call-waiting queue and the caller hears the call-waiting tone, whether or not the extension has Call Waiting activated. If the system is programmed for one-touch Transfer with automatic completion, the operator uses Camp-On by pressing the Transfer button, dialing the extension manually, activating Camp-On, hanging up, and pressing either another line button or the Transfer button again. If the operator presses an inside Auto Dial or DSS button, the transfer is automatically completed and Camp-On cannot be used.
Display	When you have a call waiting, Call Waiting appears on an MLX display telephone.
Forward and Follow Me	<p>Call Waiting does not apply to forwarded calls, because the system tries the destination extension instead of the forwarding extension. If the call is not forwarded for any reason (for example, the line/trunk selected is an unreliable loop-start line), however, Call Waiting functions normally.</p> <p>In Release 4.1 and later systems, a user with no SA or ICOM buttons available and with Forward or Follow Me turned on does not hear the call-waiting tone when a call is forwarded by using the Forward on Busy enhancement. Instead, the caller hears ringback.</p>
Group Calling	Calls made to a calling group are not eligible for Call Waiting, because the calls ring into the calling group's queue. Call Waiting can be used, however, for calls to individual members of the calling group.
Hold	If all your calls are on hold, you cannot hear the call-waiting tone.
HotLine	Call Waiting can be activated for a HotLine extension, but you cannot put the current call on hold and pick up a waiting call. Instead, you must hang up the current call and wait for the call-waiting call to ring.
Paging	Call Waiting cannot be used for Group Paging calls to busy extensions.
Personal Lines	You hear a call-waiting tone for a call received on a personal line only if your business subscribes to a call-waiting service from the local telephone company.
Pickup	Pickup cannot be used to answer a call that is waiting at another extension.
Primary Rate Interface and T1	<p>Call Waiting is available on PRI lines at extensions so programmed. The call-waiting tone at an extension is not blocked by PRI lines. Until the call is answered, answer supervision is not returned to the network and the caller hears regular ringback instead of call-waiting ringback.</p> <p>Call Waiting does not work with data calls.</p>

- Recall/Timed Flash** If Recall is used while a user is hearing special ringback, the call is disconnected and the user hears inside dial tone.
- Reminder Service** Reminder calls are not eligible for Call Waiting.
- Service Observing** In Release 6.1 and later systems, the Call Waiting tone is heard only at the extension that is receiving the call. For example, the Call Waiting tone is not heard by the observed extension if the waiting tone sounds at the Service Observer extension, and vice versa.
- If a Service Observer picks up a Call Waiting call while observing, he or she is dropped from Service Observing.
- SMDR** In Release 4.2 and later systems with the Talk Time option enabled, timing for calls to Auto Login and Auto Logout calling groups starts as soon as the system detects the calls. In Release 4.1 and prior systems, SMDR does not begin measuring the duration of a call-waiting call until the call is answered.
- System Access/
Intercom Buttons** An extension is considered busy when all SA or ICOM buttons (excluding SA Originate Only or ICOM Originate Only) are in use. With a multiline telephone, you can dial the Call Waiting feature code to pick up a waiting call only when an SA Originate Only or ICOM Originate Only button is available.
- Transfer** If a transfer is completed to a busy extension, the destination hears the call-waiting tone, if programmed, and the caller hears call-waiting ringback. The call waits in queue until the transfer return time expires. Calls answered by picking up a call-waiting call cannot be transferred.
- You can transfer a call received by using call-waiting pickup only if an SA or ICOM button on which to transfer the call becomes available.
- UDP Features** For Release 6.0 and later systems (Hybrid/PBX mode only), a private network call receives the same treatment as an outside call. The person receiving the call hears the call-waiting tone and the caller hears ringback.

Callback

At a Glance

Users Affected	Telephone users, DLC operators, data users
Reports Affected	Extension Information, Remote Access (DISA) Information, System Information (<i>SysSet-up</i>)
Modes	All
Telephones	All except QCC
Programming Codes	
Auto on	*12
Auto off	**12
Selective	*55
Feature Codes	
Selective	55
Cancel request	*55 (single-line telephones, data equipment)
MLX Display Label	<i>Cback Auto, On</i> [<i>CbckA, On</i>] <i>Cback Auto, Off</i> [<i>CbckA, Off</i>] <i>Cback Sel</i> [<i>CbckS</i>]
System Programming	Specify the number of rings to the callback originator before the system cancels a callback request: <ul style="list-style-type: none"> ■ <i>Options</i>→<i>Callback</i> Enable or disable the use of Callback for busy pools for remote access users: <ul style="list-style-type: none"> ■ <i>LinesTrunks</i>→<i>RemoteAccss</i>→<i>AutoQueuing</i>
Maximums	
Dialed digits for each queued call	40
Queued calls in the system	64
Factory Settings	
Automatic Callback rings	3 before system cancels callback request (range 1–6)
Automatic Callback	Off

Description

Callback provides an easy way to complete calls to busy extensions and, in Hybrid/PBX mode, to outside numbers when all lines/trunks are busy in the pool through which calls are made. (See [“Line Request” on page 427](#) for information about busy lines in Key and Behind Switch modes.)

Two types of Callback can be programmed for an extension:

- **Automatic.** Callback is activated automatically whenever the caller reaches a busy extension or when all lines/trunks in a pool are busy. This feature is set to on or off for each extension.
- **Selective.** Callback is activated only when a caller chooses it by dialing a feature code or, on multiline telephones, by pressing a programmed Selective Callback button. On MLX display telephones, a caller can also select the feature from the display.

When Automatic Callback is on and a caller reaches a busy extension or pool, he or she hears the queuing tone (five short beeps) instead of the busy tone. The tone indicates that the system is putting the call into the callback queue.

When a caller wishes to use Selective Callback for a call and reaches a busy extension, he or she must activate Selective Callback while listening to the busy signal. If the caller tries to make a call by using a pool in which all lines/trunks are busy, he or she hears a fast busy signal immediately after dialing the pool dial-out code. After activating selective Callback, the caller hears the queuing tone and the call is added to the callback queue.

With both types of Callback, a caller can either stay on the line until the call is completed or hang up.

- If the caller stays on the line, the red and green LEDs next to the line button are lit. When the busy extension or pool is available, the caller hears the out-of-queue tone (three short beeps) and the call is completed automatically.
- If the caller hangs up, the green LED next to the line button flashes, indicating that the button is being held for the queued call. When the busy extension or pool is available, the caller hears a priority ring (three bursts and one long ring on an MLX, ETR, or MLS telephone and three bursts of ring on an analog multiline or single-line telephone). If the user does not answer the callback call within the number of rings programmed for the system (1–6), the callback request is canceled.

For inside and outside calls, the caller hears ringback when the extension is available, but the system does not make the call until the caller picks up.

Considerations and Constraints

Callback cannot be used for personal lines assigned to buttons on a telephone. See [“Line Request” on page 427](#) for additional information. If more than one call is waiting for the same extension or pool, the call that has been queued the longest is connected first.

When a call is waiting in queue for an extension, no new calls are sent to the extension until after the queued call is completed.

When the queue contains 64 calls (system limit), additional calls sent to the queue receive a busy signal.

No more than 40 dialed digits can be included in a queued call.

In order to use Callback with pools consisting of loop-start lines, the loop-start lines must be programmed for reliable disconnect.

Mode Differences

Hybrid/PBX Mode

Callback can be used for busy extensions and for outside calls on pools where all lines/trunks are busy.

Key and Behind Switch Modes

Callback can be used only for busy extensions. Line Request is used for busy outside lines that are assigned to line buttons.

Telephone Differences

Queued Call Consoles

A QCC operator cannot use Callback.

Other Multiline Telephones

On all other multiline telephones, Selective Callback is activated by pressing a programmed Callback button or by pressing the Feature button and dialing 55. On MLX display telephones, Selective Callback is also activated by pressing the Feature button and selecting the feature from the display. If you are on another call when the system tries to call back, you hear an abbreviated ring.

On a multiline telephone, you can queue more than one call to the same extension.

On a multiline telephone, cancel a callback request by pressing the SA or ICOM button used to make the call, lifting the handset, pressing the Drop button, and pressing the SA or ICOM button again. The red and green LEDs next to the button go off, and the request is canceled.

Single-Line Telephones

A single-line telephone user can make and receive other calls while waiting for the call to be completed. The request remains in the queue until the user who initiated the request is available. Queued calls ring at a single-line telephone in the order in which they were queued.

A single-line telephone can queue only one call at a time. If a single-line telephone user who has already queued one call tries to transfer a second call to a busy pool, the transferred caller hears a fast busy tone. The system considers the transfer complete, and the call is not returned to the single-line telephone user who transferred the call.

Cancel a callback request by lifting the handset and dialing #*55 while listening to inside dial tone. The system sends a confirmation tone to indicate that the request is canceled.

A single-line telephone user cannot use Callback if another call is on hold. A waiting outside call rings at a single-line telephone before any calls queued for that extension.

Feature Interactions

Account Code Entry You should enter an account code before activating Callback. If you do not, you must wait until after the call is connected before entering the account code. Account codes cannot be entered while the call is queued.

You must enter a forced account code before Callback is activated. If not, you hear a busy tone.

Automatic Route Selection When you use ARS to make a call, and all possible line/trunk routes are busy, the call can be queued only for the first route in the pattern. If the FRL for the extension does not allow the call to be made over the route, however, the call is not queued.

If a voice call is queued for callback on a digital line/trunk pool, it can get stuck in an infinite loop of queuing. The caller hears a continuous stutter tone and cannot get rid of it. To avoid this situation, be certain to correctly program the voice and/or data capabilities of pools of PRI and BRI facilities in the ARS tables.

Barge-In If Callback is used to request a busy extension or pool and the caller is waiting on the line for the callback call, Barge-In cannot be used.

Calling Restrictions

In Hybrid/PBX mode, a person with a restricted extension can use Callback for a busy pool because restrictions are based on the specific line/trunk being used to make the call. When a line/trunk in the busy pool is available, the system checks for restrictions assigned to the extension. If the extension is restricted, a fast busy signal indicates that the call is not dialed.

Call Waiting

When Automatic Callback is used to queue a call at an extension that has Call Waiting, Callback overrides Call Waiting. The user with Call Waiting does not hear the call-waiting tone, and the call is queued until the extension becomes available.

When Selective Callback is used to queue a call at an extension that has Call Waiting, a user with Call Waiting hears the call-waiting tone and the call is queued until the extension becomes available.

Conference

A queued call cannot be part of a conference. With Automatic Callback, the call is automatically queued; however, if you try to add the queued call to the conference, the system returns a busy tone. If you use Selective Callback to queue a call while setting up a conference, the system returns a busy tone. Press the Drop button and the line button with the queued call to drop the busy tone from the conference.

Coverage

The sender and all coverage receivers must be busy before a call to the sender can be queued. The call is sent to coverage before it is put in the callback queue. Once a call is in the callback queue, it is not sent to coverage again. A callback call indicating that a busy extension or pool is available is not sent to coverage.

Digital Data Calls

Videoconferencing systems that allow you to dial feature codes using # can use Selective Callback. When a pooled line becomes available or the busy video system is idle, the queued call is made, one B-channel at a time. When the second B-channel becomes available, it can be used for the connection as well, providing the video system supports this capability.

Although video systems can use either off-hook or on-hook Callback, you should use only off-hook Callback for 2B data connections. If you use on-hook Callback, the returning callback call is connected using only one B-channel.

Automatic Callback should be disabled for digital data and videoconferencing extensions. It can be used at an MLX passive-bus extension at a desktop video workstation.

Display

When a call is queued by Automatic Callback on a multiline telephone or by Selective Callback on an analog multiline telephone, the display shows a feedback message. After the number is dialed, the display provides the same feedback as on an Automatic Callback call. When the queued call rings the user's telephone, the display indicates that it is a callback call.

Do Not Disturb	<p>Calls to extensions that are using Do Not Disturb are not eligible for callback queuing. If a callback originator is using Do Not Disturb, the system overrides the feature and the telephone rings when the busy extension or line/trunk is available.</p>
Extension Status	<p>In Hotel mode, an extension in Extension Status 1 or 2 cannot use Callback to request busy pools.</p>
Forward and Follow Me	<p>If a user queues a call and then uses Forward, Remote Call Forwarding, or Follow Me, the call does not ring back at the forwarded-to extension or telephone number; the Callback call returns only to the forwarding telephone. In Release 6.0 and later systems, Callback is not needed for Centrex Transfer via Remote Call Forwarding calls, because the same Centrex line that carried the original call is used to forward the call to the outside number.</p> <p>If an inside caller using Automatic Callback calls an extension with Remote Call Forwarding on and no pools are available, the caller hears queuing tone, but the call queues for the extension only, not for the remote number.</p> <p>When the extension becomes available, dequeuing tone sounds and the call is placed to the extension (not the Remote Call Forwarding number) if the user has stayed on the line. If the caller has hung up, priority ring is heard as the callback call is dispensed to the caller.</p> <p>In a case where no pools are available and an inside caller is not using Automatic Callback, a call to an extension with Remote Call Forwarding follows the extension's coverage path. If there is no coverage and the inside caller activates Selective Callback while listening to the busy signal, the call queues for the extension but not for the Remote Call Forward number.</p>
Forward and Follow Me	<p>In Release 4.1 and later systems, if all SA or ICOM buttons are busy at the forwarding extension, the call is automatically forwarded.</p> <p>In Release 4.0 and prior systems, if all SA or ICOM buttons are busy at the forwarding extension, the caller hears busy tone and the call is not forwarded. In this situation, the user can queue the call for callback. Callback is completed when the forwarding extension is no longer busy. If the forwarding extension and the forwarded-to extension are available, the call rings at both extensions. If the forwarded-to extension is not available, the call rings at the forwarding extension only.</p>

Group Calling	<p>Calls made to a calling group are not eligible for Callback because the calls ring into the calling group's queue. Callback can be used, however, for calls to individual calling group member extensions or to delay announcement devices. Calling group calls are not sent to a group member when the member has used Callback for a busy extension or pool, or if another person used Callback to reach the member and the callback call is ringing on the member's telephone.</p> <p>In Release 6.1 and later systems when a call is sent to a calling group with a non-local member and no tandem trunks are available, the system automatically provides Callback to queue for an available trunk.</p>
Headset Options	<p>Callback calls are answered automatically by using Headset Auto Answer, but a user hears the out-of-queue tone instead of the zip tone. When both calling and receiving users have headsets with Headset Auto Answer activated (MLX telephones only), the person being called hears the zip tone when the callback call is completed; the callback originator does not hear zip tone or dequeuing tone.</p>
Hold	<p>Pressing the Hold button while waiting for a callback call is similar to hanging up. The green LED next to the line button flashes, indicating that the button is being used for the queued call.</p>
HotLine	<p>Callback is not intended for HotLine extensions (Release 5.0 and later systems). Automatic Callback, however, can be used, if programmed, for inside and ARS (Hybrid/PBX mode only) calls. Selective Callback is also available.</p>
Line Request	<p>Returning callback calls cancel Line Request.</p>
Multi-Function Module	<p>Both Automatic and Selective Callback can be used from an MFM; a callback call, however, cannot be manually canceled because the MFM does not recognize the switchhook flash produced by pressing the Drop button.</p>
Music-On-Hold	<p>An outside caller waiting in the callback queue hears Music-On-Hold if it is programmed.</p>
Paging	<p>Callback cannot be used for calls to a speakerphone paging group. A voice-announced inside call that is queued using Callback automatically becomes a ringing call. Systems with Loudspeaker Paging can be set up to allow calls to be queued for the Loudspeaker Paging system by placing the Loudspeaker Paging jack in its own pool and having users access the paging system through the pool. When the pool is busy, the call can be queued.</p>
Park	<p>Calls waiting in a callback queue cannot be parked.</p>
Personal Lines	<p>The Callback feature cannot be used to request a busy personal line. See "Line Request" on page 427.</p>
Pickup	<p>A callback request cannot be picked up at another extension.</p>

Pools	<p>In Hybrid/PBX mode, Callback can be used to complete calls to an outside number only when all lines/trunks in the pool are busy.</p>
Primary Rate Interface and T1	<p>Callback cannot be used to request a busy PRI line assigned as a personal line, but it can be used to request a line from a pool of PRI lines. An idle PRI line is not considered an available pool member unless a check determines that it is associated with an available B-channel. Even if a B-channel is available when the pool selects a line for a queued call, there may be none available when it is time to send a setup message to the network. Or, after the setup message is sent, the network may determine that the B-channel proposed by the system is not available. In either case, the call fails and a fast busy tone is applied.</p> <p>Some applications (such as video systems) that use data lines may work improperly when releasing data facilities requested by Callback.</p>
Recall/Timed Flash	<p>If Recall is used while a user is off-hook with a queued Callback request, the call is disconnected and the user hears dial tone.</p>
Reminder Service	<p>Reminder calls cannot be queued by using Callback.</p>
Remote Access	<p>If the system is programmed for remote access, remote access users can use Callback. (The factory setting for Automatic Callback is off, but you can enable this feature in Hybrid/PBX mode only for remote access callers.) The user cannot hang up, but must wait on the line until the extension or pool is available.</p>
Service Observing	<p>In Release 6.1 and later systems a Service Observer can observe a callback call after the called extension answers the call.</p>
SMDR	<p>SMDR begins measuring the duration of a callback call when the call is completed.</p>
Speed Dial	<p>When a Stop character is programmed as part of a Speed Dial number, stay on the line, wait for the callback call, and then reactivate Speed Dial. This signals the system to continue dialing the digits following the Stop character.</p>
System Access/ Intercom Buttons	<p>Callback can be used on an SA or ICOM button. When Callback is used on an SSA button, the callback call from the system rings (and the LED next to the button flashes) only at the telephone that originated Callback.</p> <p>If a user other than the person originating Callback selects a Shared SA button with a queued callback request and lifts the handset, the user hears the queuing tone, and the green LED on the originator's telephone goes from flashing to on. If the user hangs up, the green LED on the originator's telephone goes back to flashing and the system directs the callback call to the originator. If the user does not hang up, the system directs the callback call to the user and not to the callback originator.</p>

**System Access/
Intercom Buttons
(continued)**

Selective Callback can be used from an SA or Shared SA button. The green LED next to the button at the telephone that originated Callback and all those next to other related SA and SSA buttons remain on.

Transfer

A queued callback call cannot be transferred, but calls transferred to busy extensions are eligible for Callback. When a user reaches a busy extension while transferring a call, Automatic Callback or Selective Callback can be used to queue the call before completing the transfer. The caller hears ringback or Music-On-Hold.

When the extension is available, the call is transferred to the extension automatically. If the extension is not available before the transfer return time expires, the call is removed from the callback queue and returned to the originator.

UDP Features

Callback queuing is supported for lines/trunks connected to the caller's local system, including private network tandem trunks. When a call is sent across the network and a non-local system's trunks are busy, the caller cannot queue the call using Callback.

When an extension has Automatic Callback turned on and originates a call to a non-local extension, the call is queued at the local system for Route 1 only. If all routes are busy, the caller hears callback tone. If the caller is using ARS or the non-local dial plan to call out over trunks connected to a remote system and the outside facilities at the remote system are busy, the caller hears the fast busy tone. The caller hears the busy tone if he or she is calling a busy non-local dial plan extension. Neither call activates callback queuing because the caller is not connected to the system from which the busy condition originates.

If a caller attempts Selective Callback upon hearing a busy tone and the busy condition is not derived from the originating system, Selective Callback has no effect. A caller can use Selective Callback to queue for Route 1 when all local routes for a networked call are busy.

Caller ID

At a Glance

Users Affected	Telephone users, operators, data users
Reports Affected	SMDR, System Information (SysSet-up), GS/LS Trunk Information
Modes	All
Telephones	MLX, ETR, and MLS display telephones
System Programming	LinesTrunks→More→LS-ID Delay→Entry Mode
Caller ID Number/Name Toggle Button Programming Code	*763
Special Services	Custom Local Access Signaling System (CLASS SM) Caller Identification
Hardware	800 GS/LS-ID, 408 GS/LS-ID-MLX, and 412 LS-ID-ETR modules
Factory Setting	LS-ID Delay option off
Type of Facility	Loop-start

Description

Beginning with Release 3.0, the system supports Caller ID. This feature is part of local telephone companies' Custom Local Access Signaling Service (CLASS). It provides a user with calling party number information from the central office when a call rings on a loop-start line connected to a module with Caller ID capability. This information appears on MLX, ETR, and MLS display telephones, much like the PRI Automatic Number Identification (ANI). (ETR and MLS display telephones are supported in Release 7.0 and later systems.)



NOTE:

Calling number and/or name identification is not available in all areas or jurisdictions. Check with your local telephone company. The availability of caller identification information may also be limited by the local-serving (caller's) jurisdiction, availability, or central office equipment.

Beginning with Release 7.0, the system also supports Calling Party Name, which is part of Caller ID. Calling Party Name does what its name suggests—it provides the name of the calling party. A button can be programmed on the MLX, ETR, and MLS telephones to toggle between Calling Party Number and Calling Party Name.

When the button's LED is lit, Calling Party Name and not Calling Party Number information appears and will continue to appear until you press the button again (the LED turns off).

Caller ID Modules

Three modules supply the ports capable of processing Caller ID information:

- 800 GS/LS-ID module
- 408 GS/LS-ID-MLX module (This module is backwards compatible but only supports the display of Caller ID information in Release 7.0 and later systems.)
- 412 LS-ID-ETR module (available in Release 7.0 and later systems)

LS-ID Delay Option

Caller ID information is sent from the central office during the first silent interval of ringing. Because it is possible to answer a call before this information arrives, you can turn on the LS-ID Delay option, which suppresses ringing until the Caller ID information arrives. This option can be programmed for each line. The factory setting is off.

On telephones with personal lines, the green LED next to the personal line button flashes when a call arrives on the line. The red LED lights and the telephone rings after a 6-second delay or when Caller ID information arrives, whichever occurs first. Telephones without personal lines do not receive the call until after the 6-second delay or when Caller ID information arrives.



NOTE:

The caller may hear one or two extra bursts of ringback if LS-ID Delay is programmed, while the person receiving the call has not yet heard a ring.

When the option is programmed on a two-way trunk, the system does not seize a trunk from the pool for an outgoing call while that trunk is receiving an incoming call.

The difference between LS-ID Delay and Delay Ring is that Delay Ring provides a fixed delay for all calls that arrive on the button programmed for Delay Ring. LS-ID Delay affects calls that are received on lines connected to an 800 GS/LS-ID, 408 GS/LS-ID-MLX, or 412 LS-ID-ETR module. LS-ID Delay causes a one-ring delay at every extension throughout the system on incoming calls to 800 GS/LS-ID, 408 GS/LS-ID-MLX, or 412 LS-ID-ETR modules. The call is delayed only until Caller ID information is received from the central office (on loop-start lines).

Facilities

The interface to Caller ID is provided by the 800 GS/LS-ID, 408 GS/LS-ID-MLX, or 412 LS-ID-ETR line/trunk module. These modules support Caller ID only on loop-start lines.



NOTE:

Lines/trunks used for incoming Caller ID service should not have any equipment other than the 800 GS/LS-ID, 408 GS/LS-ID-MLX, or 412 LS-ID-ETR module ports connected to them.

Display Operation

Caller ID information is displayed on MLX, ETR, and MLS display telephones. (ETR and MLS telephones are supported in Release 7.0 and later systems.) A QCC displays the Calling Party Number but not the Calling Party Name.

The display shows `No Caller ID` when the call is answered before the Caller ID data arrives, when the Caller ID data is corrupted, or when no Caller ID data is sent from the central office.

`Private` may appear if the caller has subscribed to a central office service that blocks call identification. The phrase `Out of Area` appears on the display when the call originates from a line or caller area without Caller ID or caller information, or sometimes from areas run by local service companies other than your own.

Hyphens are inserted between the digits—for example, `555-1234` for a 7-digit telephone number and `916-555-1234` for a 10-digit number.

See [“Display” on page 271](#) for more information.

Normal Incoming Call

When a call comes in on a personal line or Shared SA button, the calling party number information appears at the principal owner’s extension. Incoming call information is displayed on Line 1 of the first and second screens.

Group Calling

Caller ID information appears in the PRI ANI format without called party information.

Transferring a Call

The telephone receiving the transfer displays standard incoming call identification information until the transfer is completed. The second screen shows call transfer information. Caller ID information appears on the display.

Calls returned after the transfer return interval expires also display standard incoming call identification information.

Considerations and Constraints

General

An organization must subscribe to the Caller ID service in order for incoming calls through the 800 GS/LS-ID, 408 GS/LS-ID-MLX, or 412 LS-ID-ETR module to receive Caller ID information (loop-start lines only).

Caller ID/PRI ANI Comparison

Caller ID information arrives between the first and second ring at an extension.

PRI ANI uses the second screen of the telephone display to show the called party number, while Caller ID generally uses this page to display the facility number.

Mode Differences

Behind Switch Mode

If a customer subscribes to both Caller ID and a central office's call-waiting service on the same line, Caller ID information for the first incoming call is transmitted and appears at the display. The communications system, however, does not provide the Caller ID information for the second (call-waiting) call.

Feature Interactions

Call Waiting

If you have both the system feature Call Waiting and the central-office service Caller ID on the same line, the Call Waiting information appears on the display, but not the Caller ID information for this second incoming call.

- Centrex Operation** The 800 GS/LS-ID module can be used in Release 3.0 and later systems to capture Caller ID information (subscribed to from the central office on loop-start lines only, if available). Beginning with Release 7.0, companies can also use the 408 GS/LS-ID-MLX or 412 LS-ID-ETR module to capture Caller ID information. MLX, ETR, and MLS display telephones show the number of an outside call received on a line connected to the module. Beginning with Release 7.0, the name of the calling party also can be received. If the customer also subscribes to central office call waiting through Centrex, however, when the second call is answered by using central office call waiting, the number/name of the waiting call is not shown on the display.
- Conference** A conference originator on an MLX display telephone can view Caller ID information associated with any participant by pressing the Inspct button and the button the caller is on.
- Coverage** Caller ID information is available to users receiving coverage calls.
- Display** No Caller ID is displayed if the call is answered before the Caller ID data arrives. Calling Party Number information appears in the PRI ANI format. If selected, Calling Party Name information replaces the Calling Party Number information (Release 7.0 and later systems). Outgoing calling information, however, is not displayed.
- Do Not Disturb** Caller ID information is not displayed when a user turns on Do Not Disturb. If a user turns on Do Not Disturb while receiving Caller ID information, the information remains on the display.
- Forward and Follow Me** The systemwide LS-ID delay, if programmed, is in addition to the Forwarding Delay. The total delay is the LS-ID delay plus the Forwarding Delay.
- In Release 6.0 and later systems (Hybrid/PBX mode only), Remote Call Forwarding can be used in combination with Caller ID on a loop-start PSTN line connected to a networked system's line/trunk module with Caller ID capability. This allows Caller ID information to be sent across a private network. For each of these module's, the LS-ID Delay option must be programmed to On.
- The user at the extension that first receives the Caller ID call from the PSTN must turn Remote Call Forwarding on and specify forwarding across the network, over PRI tandem trunks only, to a non-local extension with an MLX, ETR, or MLS display telephone. When the call is received on the destination MLX, ETR, or MLS display telephone, the user sees the Caller ID information.
- In Release 6.1 and later systems (Hybrid/PBX mode only), Delay Forward can be used to send calls to a non-local extension across a private network. Caller ID information is sent with the forwarded call if PRI tandem trunks connect the systems.

Group Calling	<p>Caller ID information appears on the display. Outgoing call information is not displayed.</p> <p>In Release 6.1 and later systems (Hybrid/PBX mode only), Caller ID information can be passed across a private network that uses PRI tandem trunks. This is done by assigning the LS-ID lines connected to the 800 GS/LS-ID, 408 GS/LS-ID-MLX, or 412 LS-ID-ETR module to ring directly into a calling group containing a single non-local member. The LS-ID Delay option must be programmed to On for each line routed.</p> <p>If you press the Caller ID name/number toggle button after answering a call, the calling group label is replaced with <code>GrpCl</code>.</p>
Headset Options	<p>When using Headset Auto Answer, program the LS-ID Delay option to On to avoid loss of Caller ID information.</p>
Night Service	<p>Caller ID information appears on the display, whether or not Night Service has been activated.</p>
Personal Lines	<p>Caller ID information appears on the display of shared personal lines. Outgoing call information is not displayed.</p>
Pools	<p>If the LS-ID Delay option is programmed on a two-way line, the system does not seize a line from a pool for an outgoing call when that line is receiving an incoming call.</p>
Remote Access	<p>If a remote access call comes in on a loop-start line with Caller ID (via a jack on a module with Caller ID capability), Calling Party Number is recorded by SMDR. Calling Party Number is not retrieved on remote access lines/trunks unless LS-ID Delay is programmed to On for the line/trunk, because the calls are answered too quickly. Calling Party Name is not recorded on SMDR.</p>
Ringling Options	<p>The Delay Ring option can be used as an alternative to the LS-ID Delay option at automatically answering adjuncts so that Caller ID information is received. LS-ID Delay delays ringing at all extensions in the system, while Delay Ring delays ringing only at the extension programmed for it. Delay Ring timing starts when LS-ID Delay ends.</p>
Service Observing	<p>In Release 6.1 and later systems Service Observers do not receive Caller ID information for an observed call, including Calling Party Number, Called Party Number, Calling Party Name (Release 7.0 and later systems), Call Type, and Facility ID.</p>
SMDR	<p>Use the ISDN format if you subscribe to Caller ID, whether or not your company subscribes to PRI. The calling party number of an incoming call appears in the NUMBER field. Also, an <code>I</code> appears in the CALL TYPE field. If no information has been received from the central office, the word <code>IN</code> appears in the NUMBER field and a <code>C</code> appears in the CALL TYPE field. The calling party name is not recorded.</p>

SMDR
(continued)

If you do not use any type of delay option and you are using a device with automatic pickup, or if you manually pick up the call before the Caller ID information arrives, **IN** appears in the **NUMBER** field and a **C** appears in the **CALL TYPE** field.

**System Access/
Intercom Buttons**

Both **SA** and **Shared SA** extensions display Caller ID information on Line 1 of the first screen of the display. This information remains on the answering extension's display and is cleared from the other extensions. If another person picks up on that extension, he or she sees **In Use** on the display, and the answering extension shows **Shared Line: Ext Alpha/#** of the other extension on Line 2 of the first display screen. (**ETR** and **MLS** display telephones do not show Line 2 information.) To view information on Line 1 of Page 2, press the **More** button.

Transfer

If Caller ID information is available, the caller's telephone number is shown on Line 1 of the first screen. Outgoing call information is not displayed. The extension that initiated the transfer is shown on Line 1 of the second screen. Caller ID information is also displayed when a call returns from transfer.

UDP Features

In Release 6.0 and later systems (Hybrid/PBX mode only), if a **PRI** tandem trunk conveys a call from the receiving system to a remote networked system without user intervention, Caller ID information is also conveyed. If the tandem trunk is an analog or digital tie trunk, no Caller ID information is sent to the remote system. If a Caller ID call is transferred from the receiving system to the remote system, no Caller ID information is conveyed.

In Release 6.1 and later systems (Hybrid/PBX mode only), when a system operator transfers a call to a non-local extension by using a **DSS** with one-touch **Transfer** along with **Automatic Completion** (on a **DLC**) or **Automatic Extended Call Completion** (on a **QCC**), the Caller ID information is sent if **PRI** tandem trunks are used.

Calling Restrictions

At a Glance

Users Affected	Telephone users, operators, data users
Reports Affected	Extension Directory, Extension Information, Remote Access (DISA) Information
Modes	All
Telephones	All
System Programming	<p>Assign or remove outward/toll restriction for individual extensions:</p> <ul style="list-style-type: none"> ■ Extensions→Restriction <p>Assign or remove pool dial-out code restriction for individual extensions:</p> <ul style="list-style-type: none"> ■ Extensions→Dial OutCd <p>Assign or remove outward/toll restriction from non-tie trunks used for Remote Access including private network calls for Release 6.0 or later systems:</p> <ul style="list-style-type: none"> ■ LinesTrunks→RemoteAccss→Non-TIE Lines→Restriction <p>Assign or remove outward/toll restriction from tie trunks used for Remote Access including private network calls for Release 6.0 or later systems:</p> <ul style="list-style-type: none"> ■ LinesTrunks→RemoteAccss→TIE Lines→Restriction <p>Assign or remove outward/toll restriction for each remote access barrier code:</p> <ul style="list-style-type: none"> ■ LinesTrunks→RemoteAccss→BarrierCode→Restriction <p>Assign or remove the ARS FRL for individual extensions:</p> <ul style="list-style-type: none"> ■ Extensions→More→ARS Restrct <p>Assign or remove the ARS FRL associated with each route:</p> <ul style="list-style-type: none"> ■ Tables→ARS→Sub A FRL Or Sub B FRL <p>Assign or remove the ARS FRL associated with non-tie trunks used for Remote Access including private network calls for Release 6.0 or later systems:</p> <ul style="list-style-type: none"> ■ LinesTrunks→RemoteAccssNon-TIE→ARS Restrct

Assign or remove the ARS FRL associated with tie trunks used for Remote Access including private network calls for Release 6.0 or later systems:

LinesTrunks→RemoteAccss→TIE Lines→ARS Restrct

Assign or remove the ARS FRL for each remote access barrier code:

- LinesTrunks→RemoteAccss→BarrierCode→ARS Restrct

Factory Settings

Extensions

Outward/Toll Restriction	Unrestricted
ARS FRL	3 (range 0–6)
Pool Dial-Out Code	No access to any pool

VMI Ports

Outward/Toll Restriction	Outward
ARS FRL	0 (range 0–6)
Disallowed List	Default Disallowed List 7

ARS FRL for ARS Table

Local	2 (range 0–6)
Toll	3 (range 0–6)

Remote Access Trunks/

Barrier Codes

Outward/Toll Restriction	Unrestricted
ARS FRL	3 (range 0–6)

See [“Allowed/Disallowed Lists” on page 42](#), [“Remote Access” on page 602](#), and [“Night Service” on page 458](#) for additional calling restrictions.

Description

The Calling Restrictions features are used to control outgoing calls from individual extensions, specific pools, types of lines/trunks used for Remote Access, or specific lines/trunks associated with individual barrier codes. When used in conjunction with ARS, calling restrictions can be used to apply ARS FRLs on specific extensions, routes, types of lines/trunks used for Remote Access, and specific lines/trunks associated with individual barrier codes. (Incoming calls are never restricted.) Through calling restrictions, users at individual extensions can be restricted from making certain types of calls, as described in the following sections.

Outward and Toll Restrictions

An extension cannot be used to make toll calls if it is toll-restricted; it cannot be used to make any outside calls if it is outward-restricted.

If the restrictions are too limiting, an Allowed List can be used in conjunction with calling restrictions. An Allowed List is a list of telephone numbers (such as emergency numbers) that a user with an outward- or toll-restricted extension can dial.

A Disallowed List can be used to supplement calling restrictions on an extension or to prohibit some calls on extensions that have no calling restrictions assigned. A Disallowed List is a list of telephone numbers (for example, 900 numbers) that cannot be dialed from an extension. See [“Allowed/Disallowed Lists” on page 42](#) for additional information.

Outward Restriction for VMI Ports

In Release 3.1 and later systems, any port programmed as a VMI port is programmed with outward restriction on.

If the system manager wants to allow access to the voice messaging system Outcalling feature, the outward restriction applies to Outcalling calls.



SECURITY ALERT:

Any changes to the restrictions of these ports must be considered carefully in order to minimize the potential for toll fraud.

If the system manager changes a VMI port to a non-VMI port, the outward restriction of the port is not turned off for the port. If outward restriction should be turned off, the system manager must change it through system programming.

Pool Dial-Out Code Restriction (Hybrid/ PBX Only)

From a restricted extension, specific pool dial-out codes cannot be dialed. This restricts outgoing calls from specific pools and can be used to reserve pools for special purposes—for example, data communications.

In Release 3.1 and later systems, the factory setting is for all extensions to be restricted from using any pool.

Facility Restriction Level (Hybrid/PBX Only)

The ARS FRL is used to restrict the extension to certain routes. When ARS is used, an FRL is assigned to control or restrict access to specific routes in an ARS table. There are seven FRLs assigned to routes, ranging from 0 to 6, where 0 is the least restricted and 6 is the most restricted.

FRLs from 0 to 6 are also assigned to extensions and are used to determine whether callers have permission to use the routes. To use a route, an extension

must have an FRL equal to or greater than the route's FRL. The restrictions of the FRL assigned to an extension, therefore, are the opposite of the restrictions of an FRL assigned to a route. In other words, an extension with an FRL of 0 has the fewest ARS privileges (routes with levels 1 through 6 cannot be used), and an extension with an FRL of 6 has the most privileges (any route may be used). See ["Automatic Route Selection" on page 77](#) for additional ARS information.

Restrictions for VMI Ports

In Release 3.1 and later systems, any port programmed as a VMI port is factory-set with an FRL of 0.



NOTE:

In Release 6.0 Version 11 and later systems, the FRL of the VMI port must be equal to or greater than the FRL of the UDP route. See the *Network Reference* for details.

If the system manager wants to allow access to the voice messaging system Outcalling feature, the FRL applies to Outcalling calls.



SECURITY ALERT:

Any changes to the FRL and other restrictions of VMI ports must be considered carefully in order to minimize the potential for toll fraud.

If the system manager changes a VMI port to a non-VMI port, the FRL is not reassigned on the port. If the default FRL should be changed, the system manager must change it through system programming.

Remote Access

Outward/toll and FRL calling restrictions can also be applied to remote access users. These calling restrictions can be applied to each individual barrier code (up to 16) or, if barrier codes are not used, to all remote access tie/DID trunks and all remote access non-tie/non-DID trunks. See ["Remote Access" on page 602](#) for additional information. For Release 6.0 and later systems (Hybrid/PBX mode only), refer to the *Network Reference* for additional information for private networks.

Night Service

Other calling restrictions can be applied when Night Service is activated. Night Service can be set up to require that a password be dialed before a non-emergency number can be dialed. When the correct password is entered, the system then checks for calling restrictions assigned to each extension before allowing calls to outside numbers.

A Night Service Exclusion List can be created to exempt specific extensions from the password requirement. Normal calling restrictions (if any) assigned to the extension, however, are still in effect. A Night Service Emergency Allowed List can also be created, which can contain up to 10 numbers that can be dialed without entering the Night Service password. See [“Night Service” on page 458](#) for additional information. For Release 6.0 and later systems (Hybrid/PBX mode only), if Night Service is programmed with outward restriction, the restriction does not apply to non-local dial plan calls. Exclusion lists apply only to the local system’s extensions and do not apply to UDP calls.

Considerations and Constraints

In Hybrid/PBX mode, a user on an outward-restricted extension can receive a PSTN call, or can make or receive a private network call (Release 6.0 or later systems). Such an extension cannot be used to make an ARS call, except to emergency numbers. See [“Allowed/Disallowed Lists” on page 42](#) for additional information.

Only outgoing calls are affected; users can receive inside, local, and toll calls on restricted extensions and can join any type of call in progress.

When a user with an outward-restricted extension presses the dialpad while on a call, the call is disconnected, a fast busy signal sounds, and the line/trunk is released. The system assumes that the user is trying to make an outside call, which is not allowed because of the outward restriction assigned to the extension.

Users with Pool buttons on their telephones can use the pool even if the pool dial-out restriction is assigned to the extension.

Outward and toll restriction do not work with tie trunks or with T1 lines emulating tie trunks that are set to tie-PBX. ARS or pool dial-out codes should be used to restrict these types of line/trunks.

Because calling restrictions apply to extensions used to initiate a transfer to an outside number, a user with a restricted extension can circumvent restrictions by asking an operator with an unrestricted console to connect an outside call.

When a marked System Speed Dial code is used to dial a number, the System Speed Dial number overrides calling restrictions (such as outward or toll restrictions).



SECURITY ALERT:

The use of loop-start lines without reliable disconnect may result in toll fraud.

If Centrex service is used, any calling restrictions for the extension must be programmed by the telephone company at the central office.

Mode Differences

Hybrid/PBX Mode

In Hybrid/PBX mode, all calling restrictions can be assigned.

Key and Behind Switch Modes

In Key and Behind Switch modes, outward and toll restrictions can be assigned, while pool dial-out code restrictions and ARS FRL cannot be assigned.

Feature Interactions

Allowed/ Disallowed Lists	<p>When used with calling restrictions, Allowed Lists can permit the dialing of specific numbers (such as emergency numbers) from an outward- or toll-restricted extension.</p> <p>Disallowed Lists can prevent the dialing of specific numbers from either an unrestricted or a toll-restricted extension.</p> <p>A Disallowed List takes precedence over an Allowed List.</p>
Auto Dial	<p>A user with a restricted extension cannot dial a restricted number (outward or toll) by using an Auto Dial button unless the number is on the Allowed List for that extension.</p>
Automatic Route Selection	<p>ARS does not allow users to avoid calling restrictions. The system checks for outward or toll restrictions assigned to the extension before it selects the best route for making the call. If the ARS FRL assigned to the extension restricts use of the route, an error tone sounds and the call does not go through. Because FRL assignment determines pools selected for each route, a user may be allowed to select a pool using ARS even if the extension is restricted from the pool dial-out code.</p>
Callback	<p>In Hybrid/PBX mode, a user with a restricted extension can use Callback for a busy pool because restrictions are based on the specific line/trunk being used to make the call. When a line/trunk in the busy pool is available, the system checks for restrictions assigned to the extension. If the extension is restricted, a fast busy signal sounds to indicate that the call is not allowed.</p>
Centrex Operation	<p>Centrex users should not be assigned calling restrictions; the calling restrictions should be assigned through the central office.</p>

- Conference** With an outward-restricted extension, you cannot add an outside participant to a conference unless the participant's number is on that extension's Allowed List. A user with a toll-restricted extension can only add a participant whose toll number is on an Allowed List assigned to the extension.
- You cannot add an outside number to a conference if the number is on a Disallowed List assigned to your extension.
- Coverage** In Release 2.1 and later systems, users answering calls on Cover buttons can generate touch tones (for example, by dialing 1 to accept a collect call) if their telephones are not outward- or toll-restricted. If the telephone is outward- or toll-restricted, the user hears the touch tones, but the tones are not sent out over the line (and the user cannot, for example, accept collect calls by dialing 1).
- Directories** Using a marked System Directory listing to dial a number overrides any calling restrictions (such as toll or outward restrictions) assigned to the extension.
- Display** Call Denied appears on an MLX display when a call is denied because of calling restrictions. On an ETR display telephone, only the number dialed appears. No message is shown on an analog multiline or MLS display telephone.
- Extension Status** To allow users in the Hotel configuration of Extension Status to dial emergency or other selected numbers when the extension is in Status 1 or 2, the extension must be assigned to an Allowed List.
- Forward and Follow Me** A user with an outward- or toll-restricted extension cannot forward calls to a number (outward or toll) unless the number is on an Allowed List for that extension. No error tone sounds when a user with a restricted extension activates the Forward feature; however, when a call is received at the extension, the system checks restrictions and denies the forward if the number is not on the Allowed List.
- HotLine** Calling restrictions can be applied to HotLine extensions (Release 5.0 and later systems). The FRL value for Hotline extensions should be set to 6 to enable unrestricted access between private network switches.
- Night Service** For Night Service with outward restriction, a Night Service Emergency Allowed List must be created; it consists of emergency numbers that can be dialed from any extension without dialing the password (10 emergency numbers, 9 digits each). Any restrictions assigned to an extension on the Night Service Exclusion List are in effect when Night Service is activated.
- In Release 6.0 and later systems, Night Service restrictions do not apply to UDP calls.

- Personal Lines** A user with an outward- or toll-restricted extension cannot dial a toll or outside number on a personal line button unless the number is on an Allowed List assigned to the extension, nor can the user dial a number on a Disallowed List.
- Pools** Specific pools can be restricted from use for outgoing calls by assigning a pool dial-out code restriction to extensions. In Release 3.1 and later systems, the factory setting is for all pool dial-out codes to be restricted for all users.
- Primary Rate Interface and T1** Outward and toll restrictions do not work with T1 lines emulating tie trunks when the lines are set to Tie-PBX or Tie Switched 56 Data. ARS or pool dial-out codes should be used instead.
- Recall/Timed Flash** If Recall is used on a personal line or Pool button—or, in Release 2.0 and later systems, on an SA or ICOM button—to access an outside loop-start line, the accessed line is kept, an outside dial tone sounds and calling restrictions are reapplied.
- Service Observing** In Release 6.1 and later systems, Service Observers who are outward- or toll-restricted can still observe outside calls.
- Speed Dial** A user with an outward- or toll-restricted extension cannot dial a restricted number by using Personal Speed Dial or System Speed Dial (excluding a marked System Speed Dial code), unless the number is on an Allowed List for that extension. Using a marked System Speed Dial code, however, *does* override the calling restrictions.
- System Access/ Intercom Buttons** When a call is made on a Shared SA button, the calling restrictions that apply are those programmed for the extension with the button, not those for the principal extension.
- UDP Features** In Release 6.0 and later systems (Hybrid/PBX mode only), toll/ outward restrictions, Night Service restrictions, and the prohibition of trunk-to-trunk transfers do not apply to calls made to extensions in the non-local dial plan.
- Dial access to pools should not be permitted for pools of private trunks.

Camp-On

At a Glance

Users Affected	Telephone users, operators
Reports Affected	System Information (SysSet-up)
Modes	All
Telephones	All except single-line telephones and data equipment
Programming Code	*57
Feature Codes	57 87 (Call Waiting Pickup)
MLX Display Label	Camp On [Camp] + <i>caller's extension label</i>
System Programming	Change the amount of time before a camped-on call returns to originator: <ul style="list-style-type: none"> ■ Options→CampOn
Factory Setting	
Return Interval	90 seconds (range 30–300, in increments of 10 seconds)

Description

Camp-On allows you to complete a transfer to a busy extension. The call is put on hold until the extension can receive a call; then it rings automatically. While the call is on hold, the caller (inside or outside) hears special ringback. A call waiting tone sounds at the busy extension to indicate that a call is waiting. If you do not answer the call within the programmed Camp-On return interval (30–300 seconds), the call returns to the originator. The originator hears a priority ring (one ring and two beeps) to indicate a returning Camp-On call.

Camp-On can also be used to complete a transfer to an extension that is not busy. This can increase the amount of time before the call returns to the originator, because the return call is timed according to the Camp-On return interval (30–300 seconds) instead of the transfer return interval (1–9 rings). Camp-On can be activated by using either a programmed button or a feature code.

Considerations and Constraints

A Camp-On return interval of 30 to 300 seconds in increments of 10 seconds can be programmed. The factory setting is 90 seconds.

A call-waiting tone sounds a destination telephone when a call is camped-on, even if Call Waiting is not programmed on the destination extension.

Multiple calls can be camped on to individual extensions.

To use Camp-On, the feature must be activated while the person is listening to ringing, a busy tone, or call-waiting ringback. Camp-On cannot be activated at other times, and no error tone sounds when a caller unsuccessfully tries to use Camp-On at an inappropriate time.

In Release 6.0 and later systems (Hybrid/PBX mode only), Camp-On does not work for calls on non-local extensions.

Telephone Differences

Direct-Line Consoles

When a DLC system operator uses Camp-On to transfer a call to a busy extension, the call is placed in the call-waiting queue; the caller hears the call-waiting tone whether or not the user has the Call Waiting feature activated.

If the system is programmed for one-touch Transfer with automatic completion, an operator uses Camp-On by pressing the Transfer button, dialing the extension manually, and activating Camp-On.

If an operator presses an Auto Dial or DSS button, the transfer is automatically completed and Camp-On cannot be used.

Queued Call Consoles

A Camp-On button cannot be programmed on a QCC. Instead, the operator makes a call to a busy extension by selecting *Camp On* from the display. The call does not return to the QCC queue until the Camp-On return interval expires. If the operator presses the Release button, the extension being called receives the call-waiting tone, and the call returns to the QCC queue when the transfer return interval expires.

To use Camp-On when the system is programmed for automatic extended call completion, a QCC operator must press the Start button, dial the extension manually, activate Camp-On, and either press Release or hang up. If the operator presses a DSS button, the transfer is automatically completed and Camp-On cannot be used.

Other Multiline Telephones

Camp-On can be used with a multiline telephone when you hear ringing, a busy tone, or call-waiting ringback while transferring a call. To use Camp-On to complete the transfer, press a programmed Camp-On button, or press the Feature button and dial 57. With MLX display telephones, you can also press the Feature button and select *Camp On* from the display.

Single-Line Telephones

Calls can be camped on to single-line telephones, but you cannot use Camp-On from a single-line telephone.

Feature Interactions

- | | |
|--------------------------------|--|
| Call Waiting | If there are no buttons available to receive a transferred call, you hear the call-waiting tone when a caller uses Camp-On to transfer a call, even if Call Waiting is not activated. |
| Coverage | All individual and/or Group Coverage points must be busy before a call can be camped on to a coverage sender's extension. Coverage calls answered by a receiver can be camped-on to another user. |
| Digital Data Calls | You cannot camp onto data or video calls. |
| Direct-Line Console | When a DLC operator uses Camp-On to transfer a call to a busy extension, the call is placed in the call-waiting queue and the caller hears the call-waiting tone, whether or not the extension has Call Waiting activated. If the system is programmed for one-touch Transfer with automatic completion, the operator uses Camp-On by pressing the Transfer button, dialing the extension manually, activating Camp-On, hanging up, and pressing either another line button or the Transfer button again. If the operator presses an inside Auto Dial or DSS button, the transfer is automatically completed and Camp-On cannot be used. |
| Direct Station Selector | When Camp-On is used to complete a transfer and the call returns, the LED for the DSS button for the extension to which the call has been transferred goes off and does not flash as it does for a transfer return or Park return. |
| Display | <p>After Camp-On is activated, the MLX display shows a feedback message. The Camp-On Return display depends on whether the call is an inside or outside call and whether or not calling party information is provided.</p> <p>On the QCC only, returning camped-on calls are identified by call type and by the name and extension number of the person to whom the call was transferred. The second line of the QCC display also shows the caller information.</p> |
| Do Not Disturb | A Camp-On call does not ring when Do Not Disturb is activated. |

Forward and Follow Me	You cannot use Camp-On to complete a transfer to an extension that has any type of Remote Call Forwarding turned on.
Group Calling	You can transfer a call to a calling group by using Camp-On, but the call does not return to the originating extension, even if it is not answered within the programmed Camp-On return interval. If the calling group is made up of fax machines, a call-waiting tone is not given to the fax jack when the call is camped-on.
HotLine	HotLine (Release 5.0 and later systems) calls can be camped onto, but a HotLine extension cannot camp on to calls.
Line Request	Returning Camp-On calls cancel Line Request.
Music-On-Hold	When Camp-On is used to complete the transfer of an outside call, the caller hears Music-On-Hold until the call is answered if the transfer audible is set to Music-On-Hold. See Table 29 for more information.
Paging	You cannot use Camp-On for calls to busy speakerphone paging groups.
SMDR	If an incoming call is camped on, but not picked up by the called extension, the extension of the originator appears in the STN (station—that is, extension) field of the SMDR report. If an incoming call is camped on and picked up by the destination extension, the destination extension appear in the STN field.
System Access/ Intercom Buttons	You can pick up a camped-on call by using an idle SA Originate Only button or an idle SA button.
Transfer	<p>A transfer can be completed by using the Camp-On feature, whether or not the destination extension is busy. When the feature is used, the Camp-On return interval is used instead of the transfer return time. The Camp-On return interval is normally longer.</p> <p>A transfer can be camped on to an inside extension only. If a user presses the programmed Camp-On button or dials the Camp-On feature code while transferring a call to an outside number, the call to the outside number is disconnected. The original call remains on hold.</p>
UDP Features	In Release 6.0 and later systems (Hybrid/PBX mode only), Camp-On does not work for calls at non-local extensions.

Centralized Voice Messaging

At a Glance

Users Affected	Telephone users, operators
Modes	Hybrid/PBX

Description

For MERLIN LEGEND Communications Systems of Release 6.1 or later, a network functionality has been added that allows a MERLIN LEGEND System without a voice messaging system (VMS) to use the VMS of another MERLIN LEGEND System. The sharing of the VMS is transparent to the users of both systems. Thus, Voice Mail, Auto Attendant, and fax messaging can be used by extensions on a MERLIN LEGEND System that does not contain a VMS.

Each MERLIN LEGEND System that is sharing the VMS must be connected directly by tandem trunks to the MERLIN LEGEND System containing the VMS. No other system can be in between (see the *Network Reference* for more information).

After a message has been received for a specific extension, the VMS turns on the Message Waiting light on that extension's telephone, regardless of whether the extension is on the local or remote system.

Centralized Voice Messaging is supported with the following voice messaging systems:

- MERLIN LEGEND Mail
- Messaging 2000
- Intuity AUDIX
- IS III AUDIX Voice Power (no longer available)

See the *Network Reference* for the "Considerations," "Constraints," and "Feature Interactions" for Centralized Voice Messaging.

Centrex Operation

At a Glance

Users Affected	Telephone users, operators
Reports Affected	System Information (SysSet-up)
Modes	All
Telephones	All touch-tone telephones
System Programming	Specify mode of operation: <ul style="list-style-type: none"> ■ SysProgram→System→Mode Assign host system conference dial code: <ul style="list-style-type: none"> ■ Options→More→BehndSwitch→Conference Assign host system drop dial code: <ul style="list-style-type: none"> ■ Options→More→BehndSwitch→Drop For additional programming requirements, see “Recall/ Timed Flash” on page 590 .
Programming Codes	
Conference	*772 (for all telephones in Behind Switch mode)
Drop	*773 (for all telephones in Behind Switch mode)

Description

Centrex is an optional telephone service that business customers can obtain from telephone companies. A Centrex line provides access to telephone features similar to those available from a PBX switch located on the customer's premises. Basic Centrex features often include the following:

- Transfer
- Three-way Conference
- Drop
- Hold
- Recall
- Call Forwarding
- Call Waiting
- Call Pickup
- Group Pickup
- Automatic Callback



NOTE:

The term *communications system* here refers to the MERLIN LEGEND Communications System, as distinguished from the Centrex system provided by the central office.

Additional features, such as speed dialing and night service, may also be available from some telephone companies. Centrex features other than those specifically discussed in this section are accessed by sending a switchhook flash and dialing the appropriate feature code required by the Centrex system. These codes are not intercepted or interpreted by the communications system.

To use the features available through Centrex, dial a Centrex feature code from a touch-tone telephone or analog data device. Some features must be programmed by the telephone company at the central office. The system can be configured for either full or limited Centrex service, as described in the next two sections.



NOTE:

In Behind Switch mode, fixed Conference and Drop buttons do not work with the MERLIN LEGEND System. Instead, you must dial a programming code of *772 for Conference or *773 for Drop (or press the Feature button and dial 772 for Conference or 773 for Drop) to send a Conference or Drop signal to the MERLIN LEGEND System.

In Release 6.0 and later systems, outside calls arriving on Centrex analog loop-start facilities can be forwarded to an outside number using the Centrex Transfer via Remote Call Forwarding feature. This communications system feature allows remote forwarding of calls on the same line that received them, saving system resources by freeing the line for another call. For additional information, see [“Centrex Transfer via Remote Call Forwarding” on page 149](#) and [“Forward and Follow Me” on page 326](#).



NOTE:

The system supports Centrex on loop-start lines only, not on ground-start or ISDN facilities.

Full Centrex

Full Centrex requires each extension to have a direct Centrex line/trunk (*prime line*) to the central office. Full Centrex can also be used when only some extensions have prime lines, but the extensions without prime lines have limited ability to use Centrex features. Prime lines can be shared among extensions.

The prime line allows users to dial outside numbers directly after dialing an access code (usually 9). For this reason, any calling restrictions for the extension must be programmed by the telephone company.

The prime line is also used to call other 4-digit Centrex extension numbers that may be located at different sites served by the same telephone company. The communications system's intercom lines are used to dial other extensions in the communications system.

With full Centrex, users can send a switchhook flash by using the Recall or Flash button. The fixed-function buttons (Hold, Drop, and Transfer) control Centrex features rather than communications system features. Additional buttons can be programmed for communications system use. The communications system does not intercept or respond to Recall or fixed-function button signals. See ["Recall/ Timed Flash" on page 590](#) for additional information.

For full Centrex operation, the system must be in Behind Switch mode. A full Centrex configuration operates on three levels, as shown in [Figure 4](#). The extension user must be aware of the level where he or she is when making a call or activating a feature.

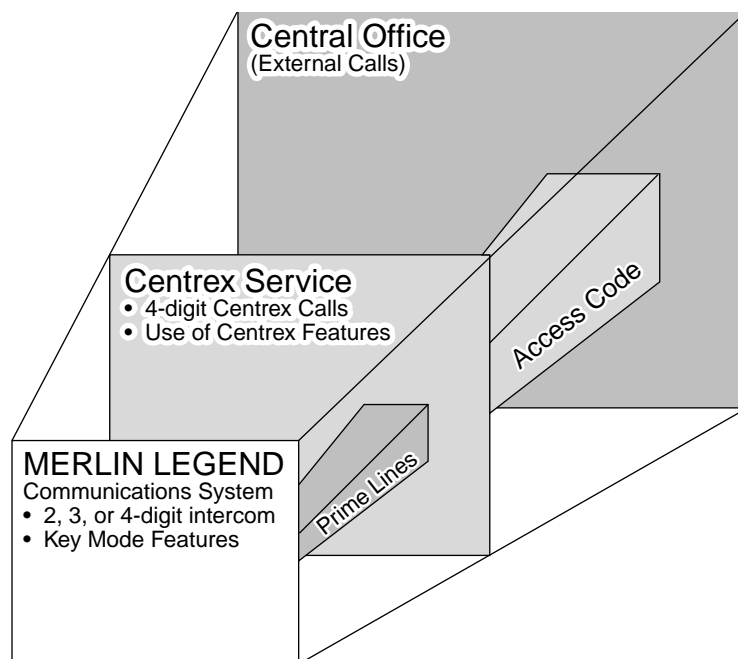

Figure 4. Full Centrex Service

Limited Centrex

With limited Centrex service, users depend principally on the communications system's features, but a limited number of prime lines can be used to access the Centrex system. There are two key reasons for selecting limited Centrex:

- Centrex lines/trunks may be less expensive than other lines.
- Different users may have different needs for telephone service, so that some users benefit more from Centrex, while other users benefit more from direct use of the communications system.

In the limited Centrex configuration, some extensions may have prime lines, while other extensions access the prime lines through a pool. Extensions can also be assigned ground-start, tie, or DID lines, which is not possible to do with full Centrex. In Hybrid/PBX mode, if your telephone does not have a prime line, you can use a Pool button to access Centrex facilities or an SA button to access pooled facilities by dialing an access code. Once connected to a pool, you can dial other Centrex extensions or dial an access code for outside calls. You can make outside calls made by using an SA button to access a pool require two access codes for outside calls: one for the pool and one for outside lines on Centrex.

For limited Centrex operation, the communications system must be in Key or Hybrid/PBX mode. The total system operates on three levels, as shown in [Figure 5](#). The extension user must be aware of the level where he or she is when making a call or activating a feature.

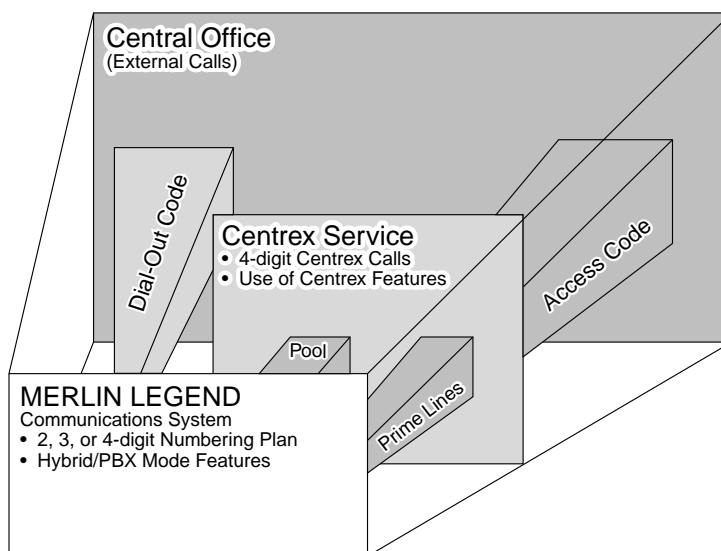

Figure 5. Limited Centrex Service

Differences between Full and Limited Centrex

Full Centrex and limited Centrex differ in where and how PBX functions are provided:

- In full Centrex, the Centrex service provides PBX-like services to all extensions.
- In limited Centrex, the Centrex service provides PBX-like services to extensions making calls at the Centrex level on prime lines, while other services are provided by the communications system, acting as a switch for calls between extensions and for calls that do not require Centrex features.

In full Centrex service:

- The communications system operates in Behind Switch mode.
- Calls can be made between Centrex extensions at separate sites served by the same Centrex.
- Key mode features are provided by the communications system.
- Intercom calls can be made between communications system extensions.
- A switchhook flash, feature access code, or Feature button-press is interpreted as intended for the Centrex service.

In limited Centrex service:

- The communications system operates in Key or Hybrid/PBX mode.
- Intercom calls can be made between communications system extensions.
- Calls to Centrex extensions require access to a prime line.
- A switchhook flash, feature access code, or Feature button-press activates the communications system feature or disconnects the call, and does not access a Centrex feature.
- Outside calls using Centrex service are made through individual prime lines or pooled prime lines.
- Other types of lines (tie, DID, and T1) can also be used for outside calls without using Centrex service.

Centrex Transfer via Remote Call Forwarding

In Release 6.0 and later systems, in full and limited Centrex systems, Centrex Transfer via Remote Call Forwarding allows the remote call forwarding of outside calls that arrive on Centrex loop-start facilities. In this context, the term *outside calls* refers to calls from outside the communications system that may originate at an extension in the Centrex system, but are not connected to the local MERLIN

LEGEND Communications System or anywhere in the PSTN. This saves line/trunk resources. Full details of this operation and its feature interactions are discussed in [“Forward and Follow Me” on page 326](#).

When an eligible call arrives and the feature is active, Centrex Transfer via Remote Call Forwarding sends a switchhook flash to the central office, which puts the call on hold and supplies Centrex dial tone for the call. The communications system then dials the programmed Remote Call Forwarding sequence and hangs up, completing the transfer and leaving the line open for other calls.

The following rules apply to Centrex Transfer via Remote Call Forwarding:

- Only outside calls arriving on loop-start Centrex lines are forwarded by using this feature. Inside calls originating locally or anywhere on a private network, using private network facilities, can be remote call forwarded, but regular Remote Call Forwarding should be used instead.
- The system must be equipped with analog Centrex loop-start lines/trunks. All analog loop-start lines in the system must be Centrex facilities. Other types of facilities may be used in the limited Centrex configuration, but calls arriving on these facilities cannot be remote call-forwarded.
- To transfer calls outside the Centrex system, the organization must subscribe to a Centrex trunk-to-trunk transfer feature. Otherwise, the feature only works for forwarding to Centrex system extensions that are, for example, not connected to the communications system.
- Transfers with consultation and conferences cannot be performed for extensions that have Centrex Transfer via Remote Call Forwarding active. Similarly, in a limited Centrex configuration that includes an automated attendant application, that application must support and be set to unsupervised transfer operation.
- The Centrex lines, the extensions programmed for Centrex Transfer via Remote Call Forwarding, and any automated attendant (limited Centrex configuration) that transfers calls to the extensions must be connected to the same switch. The feature is not supported across private networks (Release 6.0 and later systems, Hybrid/PBX mode only).
- Extension programming of Centrex Transfer via Remote Call Forwarding may require the Pause character. If so, with a multiline telephone on the communications system in a limited Centrex configuration, you can program the feature. If the feature with a dialing Pause is required for a single-line telephone, you must use the Authorization Codes feature in order to activate or deactivate Centrex Transfer via Remote Call Forwarding.

When you activate or deactivate a forwarding feature by dialing your authorization code, the activating and forwarding extensions must be on the local switch. After dialing the authorization code, you then turn the feature on or off normally.

- Reliable disconnect on loop-start lines is not required for Centrex Transfer via Remote Call Forwarding.

When extensions are using the Centrex Transfer via Remote Call Forwarding feature, do not program Music-On-Hold as the transfer audible. If Music-On-Hold is programmed in this case, a caller being transferred hears a click, three seconds of Music-On-Hold, a second click, then silence for about 10 seconds, then ringback or a busy tone from the central office. This can confuse outside callers, who may hang up.

Two SMDR call records can be generated for Centrex remote call-forwarded calls: one for the incoming or transferred call to the extension and one for the outgoing call to the remote telephone number. In order for SMDR to report the calls, the SMDR minimum call length must be set to zero (0).

Considerations and Constraints

To prevent confusion, extension numbers in the communications system should reflect the ending digits of the Centrex prime line number. For example, an extension with a Centrex prime line number of 4322 should have an extension number of 4322 in a 4-digit (Set Up Space) numbering plan, 322 in a 3-digit numbering plan, or 22 in a 2-digit numbering plan. [“System Renumbering” on page 685](#) provides information about numbering plans.

Centrex service supports only touch-tone telephones.

With full Centrex, the Recall or Flash button and fixed-function buttons (Conf, Transfer, and Drop, including the programmed ETR Drop) control Centrex functions. Corresponding communications system functions can be programmed on buttons if any are available (see [“Recall/Timed Flash” on page 590](#) for additional information). With limited Centrex, the Recall or Flash button and fixed-function buttons control communications system functions. In either case, some Centrex functions can be programmed on the Directory and on Auto Dial buttons, but not on other unused feature buttons.

Centrex service is supported only on loop-start lines. Some central offices offer Centrex features on ground-start trunks; however, the MERLIN LEGEND Communications System does not support Centrex features on ground-start trunks or ISDN facilities. Centrex service on T1 trunks with loop-start emulation is also not supported.

Full Centrex (Behind Switch mode) does not support data communications.

During high-traffic periods, the loop-start lines used by Centrex can cause *glare* when multiple calls access the same line simultaneously. Loop-start lines also have higher cable losses than ground-start lines/trunks and cannot guarantee secure toll restriction.

With limited Centrex in Hybrid/PBX mode, DID, tie, WATS, and T1 lines/trunks can be used. In Key mode, tie, WATS, and T1 lines/trunks can be used. These lines/trunks cannot be used with full Centrex in Behind Switch mode.

With limited Centrex, outside calls made by using an SA button to access a pool require two access codes: one code for the pool, and one for outside lines on the Centrex service.

Centrex users should not be assigned calling restrictions, because the system prevents an extension with calling restrictions from sending a switchhook flash to the central office. Calling restrictions should be placed through the Centrex service.

Once a call connection is made to Centrex service, the communications system cannot detect additional calls that are initiated following a Centrex switchhook flash. The SMDR and systems such as Call Accounting System (CAS), Integrated Solution II (IS II), Integrated Solution III (IS III), and Call Accounting Terminal (CAT), therefore, do not report the additional calls.

Users who have access to both Centrex and communications system features must know to which system they are connected when they attempt to use a feature. Using Centrex buttons when connected to the communications system, or using communications system buttons when connected to Centrex service, causes misdialed calls.

If a Multi-Function Module (MFM) is not being used on an MLX telephone, the second extension should be removed, in order to reduce the number of Centrex lines. The automatic assignment of two extension numbers to each MLX telephone may mean the installer must renumber the system, because the removed numbers are not automatically reassigned and their removal leaves empty places in the sequential numbering of extensions. See [“System Renumbering” on page 685](#) for additional information.

The 800 GS/LS-ID module can be used in Release 3.0 and later systems to capture Caller ID information. Beginning with Release 7.0, companies can use the 408 GS/LS-ID-MLX, 412 LS-ID-ETR, or 800 GS/LS-ID module to capture Caller ID information (subscribed to from the central office on loop-start lines only, if available). MLX, ETR, and MLS display telephones in these systems show the number of an outside call received on a line connected to the module. Beginning with Release 7.0, a name associated with the outside call can also be received. If the customer also subscribes to Call Waiting through Centrex, however, the number and/or name of the waiting call is not shown on the display. For more information, see [“Caller ID” on page 125](#).

In Release 6.0 and later systems, Centrex Transfer via Remote Call Forwarding is available only for outside calls that arrive on analog Centrex loop-start lines. The calls may arrive directly, or they may be transferred without consultation.

Mode Differences

Hybrid/PBX Mode

Hybrid/PBX mode can be used only in a limited Centrex configuration. In Releases prior to 2.0, a switchhook flash can be sent to the Centrex service only when the prime line is terminated either on a personal line or, when prime lines are shared, on a Pool button. Accessing a prime line through an SA button does not allow the switchhook flash to be sent to the Centrex service.

In Release 2.0 and later systems, Centrex lines active on an SA button (including a Shared SA button) can use Recall or switchhook flash.

Tie, WATS, and T1 lines can be used in pools. They can be used only as personal lines with Centrex service in Key and Behind Switch modes.

Key Mode

Key mode can be used only in a limited Centrex configuration.

Key mode does not require each extension to have a prime line or shared prime line in order to make Centrex calls. Key mode allows using an ICOM button to access Centrex lines. It also allows using tie, WATS, and T1 lines as personal lines.

In releases prior to Release 2.0, a switchhook flash can be sent to the Centrex service only when the line is terminated on a personal line. Accessing the same line through an ICOM button does not allow the switchhook flash to be sent to the Centrex service.

In Release 2.0 and later systems, Centrex lines active on an ICOM button can use Recall or switchhook flash.

Behind Switch Mode

For full Centrex configuration, the communications system must be in Behind Switch mode.

Behind Switch mode does not support MERLIN Mail, MERLIN LEGEND Mail, AUDIX Voice Power, Call Accounting System (CAS), or Call Management System (CMS). These applications are supported only in Key and Hybrid/PBX modes.

Full Centrex service supports only loop-start facilities. While lines that are not loop-start lines are not blocked by the communications system, they can cause dialing errors. Even random use of modules that are not loop-start (such as E&M modules) throws off the default line assignments. If boards other than loop-start boards must be used, they must be positioned after the last loop-start line module,

or prime lines on later modules may be assigned incorrectly. If a DS1 module is used, it must be placed after all loop-start boards on the system so that default line assignments on the communications system are not affected.

Digital facilities are not supported in Behind Switch mode.

In Behind Switch mode, during periods of high telephone traffic, you may experience delays in obtaining dial tone from the Centrex system. This could cause misdialing when using System or Personal Speed Dial.

Calls to calling groups in a system set up in Behind Switch mode follow the communications system ring pattern, not the central office ring pattern.

Telephone Differences

Multiline Telephones

MLX Telephones

On MLX telephones, special ringing patterns are used to differentiate various call types. If personalized ringing is used, the personalized ring comes before the distinctive pattern.

- Centrex intercom calls are indicated by the personalized ring followed by a beep.
- Centrex special or priority calls are indicated by the personalized ring followed by three short rings.
- Outside calls are indicated by the personalized ring followed by two short rings.
- Centrex special signaling is indicated by the facility-tracking tone.

Adjuncts connected to a Multi-Function Module (MFM) on an MLX telephone cannot send a switchhook flash to the Centrex line. (Whenever possible, such adjuncts should be attached to a 012 (T/R) module or a 016 (T/R) module, or, in Release 7.0 and later systems, to 412 LS-ID-ETR or 016 ETR module ports that have been programmed for tip/ring operation.)

ETR, MLS, and Analog Multiline Telephones

On ETR, MLS, and analog multiline telephones, special ringing patterns differentiate various call types. If personalized ringing is used, the personalized ring comes after the distinctive pattern.

- Centrex intercom calls are indicated by a beep followed by the personalized ring.
- Centrex special signaling is indicated by the facility-tracking tone.

- Centrex special or priority calls are indicated by two short rings followed by the personalized ring.
- Outside calls are indicated by one short ring followed by the personalized ring.

Single-Line Telephones

When single-line telephones are used in Behind Switch mode, a prime line is assigned automatically to the extension.

Centrex service supports only touch-tone telephones.

When single-line telephones are connected directly to a prime line, they have limited functionality because they cannot access communications system features or make intercom calls. They can, however, use all the Centrex features by dialing the proper access codes.

If a single-line telephone has the Idle Line Preference programmed for an ICOM Ring button, all communications system features are available. You can access Centrex lines and features by dialing the Centrex access code. With a single-line telephone, however, you cannot use the communications system's Conference, Transfer, or Drop, because the switchhook flash goes directly to the Centrex line and is not intercepted or interpreted by the communications system.

Single-line telephones should be connected by using a 012 (T/R), 016 (T/R), or Off-Premises Telephone (OPT) module, or, in Release 7.0 and later systems, to 412 LS-ID-ETR or 016 ETR module ports that have been programmed for tip/ring operation. If a single-line telephone is connected to an MFM, it cannot send a switchhook flash.

In Hybrid/PBX mode, special ringing patterns are used on single-line telephones to differentiate various call types (personalized ringing is not available):

- Centrex intercom calls are indicated by two-burst ringing.
- Centrex special or priority calls are indicated by three-burst ringing.
- Outside calls are indicated by three-burst ringing.
- Centrex special signaling is not indicated.

Feature Interactions

- Authorization Code** In Release 6.0 and later Key or Hybrid/PBX mode systems, you can activate or deactivate forwarding features, including Centrex Transfer via Remote Call Forwarding but excluding Follow Me, at an extension on the system by entering the authorization code for the extension on the same system from which calls are to be forwarded. You enter the authorization code, then activate or deactivate the feature in the normal fashion. This is especially useful for a single-line telephone where you must include a Pause character in a Remote Call Forwarding dialing sequence, because the character cannot be dialed at a single-line telephone. It is also useful when you must change forwarding options for a phantom extension.
- Caller ID** The 800 GS/LS-ID module can be used in Release 3.0 and later systems to capture Caller ID information. Beginning with Release 7.0, companies can use the 408 GS/LS-ID-MLX, 412 LS-ID-ETR, or 800 GS/LS-ID module to capture Caller ID information (subscribed to from the central office on loop-start lines only, if available). MLX, ETR, and MLS display telephones in these systems show the number of an outside call received on a line connected to the module. Beginning with Release 7.0, the name of the calling party also can be received. If the customer also subscribes to call waiting through Centrex, however, the number/name of the waiting call is not shown on the MLX display.
- Calling Restrictions** Centrex users should not be assigned calling restrictions; the calling restrictions should be assigned through the central office.
- Conference** In Behind Switch mode, the fixed-function Conf button applies to Centrex operation and is not recognized by the communications system. A button can be programmed for communications system Conference.
- In Behind Switch mode, the fixed-function Drop button applies to Centrex operation and is not recognized by the communications system. A button can be programmed for communications system Drop.
- Forward and Follow Me** In Release 6.0 and later systems using the limited Centrex configuration, outside calls may be remote call-forwarded on the same analog Centrex loop-start line on which they arrived.
- You can activate or deactivate Forwarding or Remote Call Forwarding by entering the authorization code for the extension from which calls are to be forwarded. You enter the authorization code, then activate the feature within 15 seconds of entering the authorization code.
- Group Calling** Calls to calling groups in a system set up in Behind Switch mode follow the communications system ring pattern, not the central office ring pattern.
- Recall/Timed Flash** In Behind Switch mode, a Recall button should be programmed to send switchhook flash to activate Centrex features. The system supports the use of a Recall button only on loop-start lines.

SMDR	In Release 6.0 and later systems, two SMDR call records can be generated for Centrex remote call-forwarded calls: one for the incoming or transferred call to the extension and one for the outgoing call to the remote telephone number. In order for SMDR to report the calls, the SMDR minimum call length must be set to zero (0).
Speed Dial	During periods of high traffic, you may experience a delay in obtaining a dial tone from the Centrex service. This could cause misdialing when using System Speed Dial or Personal Speed Dial. Pause characters can be programmed as part of the Speed Dial number after entering the access code.
Transfer	In Behind Switch mode, the fixed-function Transfer button applies to Centrex transfers and is not recognized by the communications system. A button can be programmed for communications system Transfer.

Conference

At a Glance

Users Affected	Telephone users, operators
Reports Affected	System Information (SysSetup)
Modes	All
Telephones	MLX, ETR, and MLS telephones and analog multiline telephones, except MLC-5 cordless telephone.
Programming Codes	
ETR (and MLS) Drop button	*777 (for ETR and MLS telephones in Hybrid/PBX or Key modes)
MLX Display Label	Conference [Conf] Drop [Drop]
Maximums	
Multiline telephones	5 participants (originator + 2 inside, 2 outside)
Single-line telephones	3 participants (originator + 2)

Description

Conference allows conference calls that include people on inside lines, outside lines, or both.

Adding Conference Participants

You can consult privately with each participant before adding the person to the conference. Anyone who shares a personal line or Shared SA button with the originator can join the conference on that button and is counted as a participant.

Dropping Conference Participants

In Hybrid/PBX and Key modes, by using the fixed Drop button on an MLX or analog multiline telephone, you can selectively drop conference participants while a conference is in progress. A QCC operator, however, cannot selectively drop participants from a conference. When a QCC operator presses the Drop button, only the most recently added participant is dropped. On a single-line telephone, you can drop the most recently added participant from the conference by issuing a switchhook flash.



NOTE:

ETR and MLS telephones have no fixed Drop buttons. Instead a Drop button can be programmed in Hybrid/PBX and Key modes by dialing a programming code of *777 or by pressing the Feature button and dialing 777.

Leaving a Conference

The conference originator can leave the conference by pressing the Hold button (the conference continues). If a conference originator (excluding a QCC operator) leaves a conference by either hanging up or selecting another line, the entire conference is disconnected.

Considerations and Constraints

Transmission quality may vary during the conferencing of outside lines.

A call to a busy number cannot be added to a conference.

Pressing the Drop button and the line button for a participant also disconnects a participant who joined the conference by using a shared personal line or an SA or ICOM button.

When a conference originator puts the conference on hold, Music-On-Hold is not activated.

In Release 1.1 and later systems, the system automatically selects an SA or ICOM button when a user presses the Conf button. In Release 1.0 systems, the system does not automatically select an SA or ICOM button; you must select the line manually.

Beginning with Release 1.1, pressing the Conf button causes one of the following to happen:

- If the system is in Hybrid/PBX mode and SA buttons are available, the system automatically selects one, in the following order:
 1. SA Originate Only (Ring)
 2. SA Originate Only (Voice)
 3. SA Ring
 4. SA Voice
- If the system is not in Hybrid/PBX mode or no SA button is available, the prompt *Select a Line* appears on Line 2 of the display on an MLX display telephone.

After the system selects an SA button or the originator selects a line on an MLX display telephone, Line 2 displays the prompt `Dial`. The originator can either dial a number or select another line. Line 1 shows call-handling information, such as dialed digits, while Line 2 is unchanged. The originator should then press `Conf` to connect all parties. The prompt on Line 2 is replaced by the date and time. Line 1 displays the number of parties in the conference.



SECURITY ALERT:

If the system selects a voice button, the caller hears a beep instead of ringing. If a person does not answer at the destination extension and the originator completes the conference, the conversation of the other parties is broadcast on that extension's speaker. The originator must be sure to drop the unanswered destination extension on a voice button to prevent this from happening. If the Conference feature is frequently used, the system manager should consider using the Transfer Type setting of Ring rather than Voice, to avoid this problem.

If the conference originator presses the `Conf` button, selects a line button, dials a number, and presses the `Conf` button again before the person being called answers, all conference participants hear ringback, which may cause voices to cut in and out. If the conference originator calls a co-worker and presses the `Conf` button, and the co-worker while on hold for the conference presses a `Hold`, `Conf`, or `Transfer` button, the call is disconnected.

If a conference participant (excluding the originator) who is included on a conference call on an SA or ICOM button leaves the conference temporarily by putting the call on hold and then rejoins the conference on a shared personal line or Shared SA button, the person is connected to the conference. The LED for the original conference call line on the SA or ICOM button, however, turns off.

In Release 2.1 and later systems, a call on hold at a programmed `Cover` button can be added to a conference by an originator with a personal line for the call.

In Release 6.0 and later systems (Hybrid/PBX mode only), calls to non-local dial plan extensions are treated as outside calls for the purpose of conferencing. Each non-local conference participant takes up one of the two outside calls permitted in a conference. For example, if you have added two outside calls to a conference, you cannot add a non-local extension. Similarly, if two outside parties are already participating in a conference, and an attempt is made to add a third participant on the local switch, the local user can be added if he or she answers the call.

Mode Differences

Behind Switch Mode

The fixed Conf button on multiline telephones activates conference from the host system. The dial codes for the host system for Conference and Drop must be system-programmed. A multiline telephone user can program a Conference or Drop button to use the communications system's Conference or Drop features as described above.

A single-line telephone user cannot use the Conference feature in Behind Switch mode.

Telephone Differences

Queued Call Consoles

To arrange a conference call using a QCC, the operator presses the Conf button after receiving a call or dialing the first outside number or extension. The green LED next to the Call button flashes to indicate that the person is on hold for the conference. An outside participant hears Music-On-Hold if it is programmed; an inside participant hears nothing. Then the operator dials the next number and presses the Conf button again; all participants are connected.

To add another person, the operator presses the Conf button again. The green LED next to the Call button flashes, indicating a call on hold, and the participants can converse. The operator adds more participants by dialing their numbers and pressing the Conf button until up to two outside lines and three extensions (including the operator and the originator) are added. The operator can converse privately with each participant before pressing the Conf button to join other participants. (This is called *Conference with consultation*.)

Calls to busy numbers cannot be added to a conference. To disconnect a call to a busy number, the operator presses the Call button with the conference call and then continues adding participants, if desired.

All conference participants are connected together on one Call button. This allows the operator to put the conference on hold and to use other Call buttons to make or receive other calls. Since all participants are on one Call button, the operator can drop only the last party added to the conference by first pressing the Drop button and then the Call button used to originate the conference.

To rejoin a held conference call, a QCC operator presses the Call button with the conference participant. To end the conference, the operator joins the conference

and presses the Forced Release button; all participants are disconnected. If instead of pressing the Forced Release button, the operator hangs up, the conference is put on hold. When the operator arranges a three-participant conference (the operator and two other participants) and then presses the Release button or hangs up, the operator is released from the call and the other two participants remain connected. If the operator arranges a three- or four-participant conference, pressing the Release button has no effect; however, if the operator hangs up, the conference is put on hold.

Other Multiline Telephones

To arrange a conference call by using a multiline telephone, press the Conf button after receiving a call or dialing the first outside number or extension. The green LED next to the button used to make the call flashes, indicating that the person is on hold for the conference. While on hold for a conference, an outside participant hears Music-On-Hold, if programmed, while an inside participant hears nothing. To add another participant, select another line button, dial the next number, and press the Conf button again. Pressing the Conf button a second time connects all participants, including you.

To add another person, press the Conf button again. The green LEDs next to the line buttons flash, but the participants can converse. Then select a line or dial a number, and press the Conf button again. Repeat the process for other conference participants. Up to two outside lines and three extensions, including yours, can be in the conference. You can converse privately with each participant before pressing the Conf button to join other participants. This is called *conference with consultation*.

Calls to busy numbers cannot be added to a conference. An originator who reaches a busy number can press any of the line buttons associated with the conference call to disconnect the call to the busy number before continuing to add participants.

To selectively drop a participant, press the Drop button followed by the line button for the participant to be dropped. To leave the conference call temporarily without disconnecting the call, press the Hold button. To rejoin a held conference call, press any line button representing a conference participant. To end the conference, hang up; all participants are disconnected.

A Drop button is automatically assigned to Line 6 on MDC 9000 and MDW 9000 telephones.

Single-Line Telephones

A total of three participants can be included on a conference call originated from a single-line telephone. To arrange a conference call using a single-line telephone, press and release either the Recall or Flash button or the switchhook (only if the

telephone does not have positive disconnect) after receiving a call or dialing the first outside number or extension. The participant automatically goes on hold. While on hold, an outside participant hears Music-On-Hold, if programmed, while an inside participant hears nothing. To add the next participant, dial another number and press and put the current call on hold again. All participants are connected on the conference call.

You can converse privately with each participant before adding other participants. This is called *conference with consultation*.

Calls to busy numbers cannot be added to a conference. If you reach a busy number, you can press and release either the Recall or Flash button or the switchhook to drop the outside line.

A single-line telephone user can drop the most recently added participant from the conference by pressing and releasing either the Recall or Flash button or the switchhook.

If a single-line telephone with a timed or positive disconnect (for example, Lucent Technologies model 2500YMGK, 2500MMGK, or 8110M) is used, pressing the switchhook disconnects the call. With this type of telephone, the Recall or Flash button must be used instead of the switchhook to add a conference participant or drop the most recently added conference participant. The 8100M telephone must have positive disconnect programmed on the telephone, as described in its user guide.

Feature Interactions

- | | |
|--------------------------------------|--|
| Account Code Entry | A separate account code must be entered for each outside call added to the conference. |
| Allowed/
Disallowed Lists | <p>With a restricted extension, you cannot add a participant (outside or toll) to a conference call unless the participant's number is on the Allowed List for that extension.</p> <p>You cannot add an outside number to a conference if the number is on a Disallowed List assigned to your extension.</p> |
| Authorization Code | <p>Enter an authorization code before each outside call for a conference is made.</p> <p>You may enter a different authorization code for different outside calls. This may be useful if different restriction privileges are required for different outside calls for the conference.</p> |
| Auto Dial | When programming an Auto Dial button, press the Conf button to enter the Flash special character in a telephone number programmed on an Auto Dial button. Press the Drop button to enter the Stop special character in a telephone number programmed on an Auto Dial button. |

Barge-In Barge-In can be used to interrupt conference calls; all participants hear the Barge-In tone. Barge-In, however, does not connect you to a conference call if the conference already has the maximum number of participants. If Barge-In is used to connect to a conference call that involves an outside line/trunk and the person on the outside line/trunk hangs up, the person using Barge-In is also dropped.

Basic Rate Interface Calls on BRI lines can be part of a conference call that is processed by the MERLIN LEGEND Communications System rather than by the central office. The MERLIN LEGEND Communications System determines the number of active parties on the call.

The MERLIN LEGEND Communications System supports up to five people on a conference: two within the system, two outside the system, and the call originator.

If a MERLIN LEGEND Communications System user is part of a conference established by an outside party through the central office conference feature, the MERLIN LEGEND Communications System may play Music-On-Hold (if so programmed) when the user puts the call on hold.

Call Waiting A call-waiting tone is heard only by the person receiving the call and not by other conference participants. If the conference originator reaches a busy extension, hears the call-waiting special ringback, and tries to add the call to the conference, the system returns a busy tone. To drop the busy tone from the conference, the originator must press the Drop button and then press the line button used to call the busy extension.

Callback A queued call cannot be part of a conference. With Automatic Callback, the call is automatically queued; however, if you try to add the queued call to the conference, the system returns a busy tone. If you use Selective Callback to queue a call while setting up a conference, the system returns a busy tone. Press the Drop button and the line button with the queued call to drop the busy tone from the conference.

Caller ID A conference originator on an MLX display telephone can view Caller ID information associated with any participant by pressing the Inspct button and the button the caller is on.

Calling Restrictions With an outward-restricted extension, you cannot add an outside participant to a conference unless the participant's number is on that extension's Allowed List. A user with a toll-restricted extension can only add a participant whose toll number is on an Allowed List assigned to the extension.

You cannot add an outside number to a conference if the number is on a Disallowed List assigned to your extension.

Conference

In Behind Switch mode, the fixed-function Conf button applies to Centrex operation and is not recognized by the communications system. A button can be programmed for communications system Conference.

In Behind Switch mode, the fixed-function Drop button applies to Centrex operation and is not recognized by the communications system. A button can be programmed for communications system Drop.

Coverage

You can originate a conference call from a Cover button only when you press the Transfer button, dial the number for another person, and then press the Conf button to complete the transfer. In this case, however, instead of the call being transferred, a conference call with three participants (including the originator) is established.

CTI Link

CTI link applications can control conferences of up to three parties, including those where one or two parties are outside the system.

When performed by a QCC operator or unmonitored DLC operator, the Conference feature generates screen pop at screen pop-capable destinations.

When a conference is initiated manually at the telephone of an extension using a CTI application, screen pop is initiated for inside parties only (not initiated for outside parties) at screen pop-capable destinations, even when the application is used to complete the conference.

If the non-local dial plan recipient of a conference call is a PassageWay Telephony Services client, the recipient's display shows caller information about the conference originator, not about any other caller. Users at CTI-linked PassageWay Telephony Services extensions must use the telephones at their extensions to add conferees to a conference. They cannot use their PassageWay

Digital Data Calls

Conference does not function with data calls.

Video application conference features do not function with the system.

2B data video calls require both B-channels at a video workstation. For this reason, if a call is on hold for conferencing at a passive-bus MLX telephone when a 2B call comes in, the passive-bus MLX telephone cannot retrieve the held call until the 2B video call is over.

Directories

The Extension, Personal, and System Directory features can be used to set up conference calls. Press the Conf button to enter the Flash special character in a Directory listing telephone number. Press the Drop button to enter the Stop special character.

Display As with any other call, the dialed digits appear on Line 1 of the display as you set up a conference call. On MLX and ETR telephones, Line 1 of the display shows the number of conference participants. In addition, the MLX telephone display prompts you each time you press the Conf button. The display on an MLX telephone also prompts you to drop a conference participant after you press the Drop button; the updated conference information then appears on Line 1, and the line or extension that was dropped appears on Line 2.

Beginning with Release 1.1, if the system is not in Hybrid/PBX mode or you have no available SA or ICOM button, the prompt *Select a Line* appears on Line 2 of the display on an MLX telephone. After the system selects an SA or ICOM button line or the originator selects a line, Line 2 displays the prompt *Dial*. After dialing a number or selecting another line, the prompt on Line 1 changes to show call-handling information, such as dialed digits. To connect all parties, press Conf. The prompt on Line 2 is replaced by the date and time, while Line 1 displays the number of parties active on the call.

Fax Extension If an extension is programmed as a fax extension, the telephone at that extension is unable to use the Conference feature.

Forward and Follow Me When calls received on a personal line are forwarded to an outside telephone number, another user who shares the personal line and the line/trunk selected to forward the call can join the in-progress call by pressing the personal line button. In this case, the person joining the call is considered the conference originator, and the forwarded call can be conferenced. If the person joining the call hangs up, all participants on the conference call are disconnected.

In Release 6.0 and later systems, if you conference a call on a Centrex analog loop-start line when an extension has activated Centrex Transfer via Remote Call Forwarding, the call is not forwarded.

Group Calling Calls waiting in the calling group queue or ringing at a calling group member's extension cannot be added to a conference call. A user must be connected to a calling group member before the call can be added to the conference.

Headset Options Headset Auto Answer is turned off automatically while the user sets up a conference and must be turned back on manually.

- Hold** When adding other participants to a conference, the conference originator hears the hold reminder when the conference is on hold for longer than one minute (if the originator is a telephone user) or for longer than the operator hold timer setting (if the originator is an operator).
- If DLC operator automatic Hold is programmed and used by a DLC operator while setting up a conference, the entire conference goes on hold.
- Both parties on an inside call cannot put each other on hold. If a user presses the Hold button while waiting on hold for a conference initiated by another user (an inside call) or if the user presses the Conf button while waiting on hold on an inside call, the entire conference call is disconnected.
- The initiator of a conference call can leave the conference by pressing Hold. The conference initiator can rejoin the conference call by pressing the line button of any conference participant.
- In Release 2.1 and later systems, a call that has been put on hold on a Cover button can be added to a conference by a user who has a personal line for the call.
- HotLine** Conference is not available at HotLine extensions (Release 5.0 and later systems).
- Inspect** If you press the Conf button while Inspect is activated, Inspect is canceled and the system tries to activate the Conference feature.
- When a user joins a conference by using a shared outside line or Shared SA button, the QCC display reflects the correct number of participants. If the QCC operator uses the Inspect feature to verify the number of participants, however, the number shown on the display does not include participants joining the conference on a shared button.
- Multi-Function Module** The Conference feature cannot be used on the MFM because the system ignores the switchhook flash sent by the MFM.
- Music-On-Hold** If the first participant put on hold for a conference is an outside call, the caller hears Music-On-Hold until the second participant is added. When a conference originator puts the conference on hold, Music-On-Hold is not activated.
- Paging** You cannot add speakerphone and loudspeaker paging calls to a conference.
- Park** You cannot park conference calls. If a QCC operator tries to park a conference call by pressing the Start button and then pressing the DSS button for the park zone, the park is denied and the operator is reconnected to the conference call.

- Pickup** You cannot pick up a conference call at another extension. A conference originator, however, can pick up a call and add it to the conference.
- Recall/Timed Flash** The Conf button is used to enter the Flash special character, which simulates pressing the Recall button in telephone numbers programmed for Directories, Auto Dial buttons, or Speed Dial codes.
- In Hybrid/PBX and Key modes, a single-line telephone user with a Recall or Flash button can add a participant to a conference call and connect all participants by using the Recall or Flash button. In addition, the Recall or Flash button can be used either to drop the most recently added participant or to drop a busy number.
- In Behind Switch mode, the fixed Conf button on an MLX, ETR, MLS, or analog multiline telephone must be set through system programming to send a timed flash plus the code expected by the host switch to activate conference on the host. If the communications system's Conference feature is also desired, it must be assigned to an available line button on each multiline telephone through extension or centralized telephone programming. Recall has no effect on a completed conference call.
- Remote Access** An inside user can initiate a conference with the callers involved in a remote access call by selecting the active remote access line/trunk.
- Service Observing** In Release 6.1 and later systems, Service Observing does not interfere with the use of the conference feature by observed extensions. While observing an extension, Service Observers cannot use the Conference feature; a press of the Conf button is ignored by the system. The consultation portion of a call may be observed. Any member of a conference call that is observed does not receive the conference display.
- Service Observing follows the MERLIN LEGEND limitations for calls—namely that no more than three internal extensions can be on one call, whether it is an outside or inside call. Consequently, a Service Observer is dropped from a call when the observed extension places the call on hold for conferencing. If one of the conferencing parties is outside the system, the Service Observer is reconnected when the conference is complete. If the conferencing parties are all internal, the Service Observer is *not* reconnected when the conference is complete.
- Although a Service Observer may be dropped from a conference call, the Service Observing session is still active for the observed extension. When the observed extension receives another call after the conference call, the Service Observer is connected to the call.
- An observed extension cannot use Selective Drop to drop a Service Observer from a call, nor can a Service Observer use Selective Drop to hang up an observed call.

- Signal/Notify** Signal and Notify can be used during a conference.
- SMDR** When a conference call includes inside and outside participants, records are generated only for outside participants. If you drop a call from a conference call, it is considered a completed call and is recorded.
- Speed Dial** Press the Conf button to enter the Flash special character in a Personal Speed Dial or System Speed Dial telephone number. Press the Drop button to enter the Stop special character.
- System Access/
Intercom Buttons** Calls on SA and ICOM buttons (including Shared SA buttons) can be included in a conference call. If a user involved in a conference call on an SA or ICOM button also has an SSA button for one of the conference participants, the call is active at the SA or ICOM button and not at the SSA button for the other participant.
- Transfer** A conference call cannot be transferred. A user who starts a conference sequence, however, can complete it by pressing the Transfer button and transferring the original call instead of completing the conference. Similarly, if a transfer originator has one person on hold for transfer and, after dialing the destination extension or telephone number, decides to establish a conference call, he or she can press the Conf button to establish the conference instead of completing the transfer.
- UDP Features** In Release 6.0 and later systems (Hybrid/PBX mode only), calls to a non-local dial plan extension are treated as outside calls for the purpose of conferencing. For example, if you have added two outside calls to a conference, you cannot add a non-local extension. When a call on a conference is added or dropped, the display at a non-local extension is not updated. At a PassageWay Telephony Services client, a call cannot be added or dropped using the application; the user must use the telephone and/or the display. The CTI-linked client, when at a non-local extension, receives information only about the conference originator, not about any outside or inside conferees.

Coverage

At a Glance

Users Affected	Telephone users, DLC operators, data users
Reports Affected	Direct Group Calling Information, Extension Information, Group Coverage Information, Operator Information System Information (<i>SysSet-up</i>)
Modes	All
Telephones	
Individual sender	All except QCC
Individual receiver	All multiline telephones except QCC
Group member (sender)	All except QCC
Group receiver	Multiline telephones, QCC queue, calling group (if calling group, no others)
Programming Codes	
Sender buttons	
Coverage Off	*49
Coverage VMS Off	*46
Receiver buttons	
Primary Cover	*40 + sender's ext. no.
Secondary Cover	*41 + sender's ext. no.
Group Cover	*42 + sender's group no.
Coverage Inside Off	**48 (send outside calls only)
Coverage Inside On	*48 (send inside and outside calls)
MLX Display Labels	CoverageOff [CvOff] CoverInside,Off [CvIns,Off] CoverInside,On [CvIns,On] Coverage VMS off [Cvvms,off] Coverage,Primary [Cover,Prmry] Coverage,Secondary [Cover,Secnd] Coverage,Group [Cover,Group]

System Programming

Assign extensions to a coverage sender group:

- Extensions→More→Group Cover

Assign a calling group as a Group Coverage receiver:

- Extensions→More→Grp Calling→GrpCoverage

In releases prior to 4.1, change number of rings before call is sent to Group Coverage receivers:

- Options→More→Cover Delay

In Release 4.1 and later systems, change number of rings before call is sent to Group Coverage receivers:

- Extensions→More→More→Cover Delay→Group Cover→sender's ext. no.→Enter→no. of rings (1-9)

In releases prior to 4.1, change delay for Cover button programmed for Delay Ring; change additional delay before call is sent to Group Coverage receivers:

- Options→Delay Ring

In Release 4.1 and later systems, change the delay for Primary Cover buttons programmed for Delay Ring; change additional delay before a call is sent to Group Coverage receivers when Primary or Secondary Coverage Receivers are available:

- Extensions→More→More→Cover Delay→Primary→sender's ext. no.→Enter→no. of rings (1-6)

In Release 4.1 and later systems, change the delay for Secondary Cover buttons programmed for Delay Ring:

- Extensions→More→More→Cover Delay→Secondary→sender's ext. no.→Enter→no. of rings (1-6)

Assign or remove principal user of a personal line (calls follow coverage pattern of principal user only):

- LinesTrunks→More→PrncipalUsr

Assign QCC queue as receiver for specific coverage groups and assign QCC Queue Priority for Group Coverage calls:

- Operator→Queued Call→Call Types→GrpCoverage→Priority

Assign QCC operator to receive calls for a coverage group:

- Operator→Queued Call→Call Types→GrpCoverage→Operator

Maximums

Individual Coverage receivers for each extension (sender)	8
Group Coverage receivers for each coverage group (senders)	8 (not counting QCC queue)
Group memberships for each extension (sender)	1
Cover buttons for each multiline telephone (receiver)	8
Coverage groups	30
Members for each coverage group	Unlimited
Coverage groups sending to one calling group <i>or</i> QCC queue	30

Factory Settings

Extensions

Coverage	On
Coverage Inside	On (inside and outside calls covered)
Coverage VMS	On (inside and outside calls covered by VMS)
Group Coverage Ring Delay (4.1 and later systems)	3 rings (range 1–9)
Primary Cover Ring Delay (4.1 and later systems)	2 rings (range 1–6)
Secondary Cover Ring Delay (4.1 and later systems)	2 rings (range 1–6)

Systemwide

Delay Ring Interval (4.0 and prior systems)	2 rings (range 1–6)
Coverage Delay Interval (4.0 and prior systems)	3 rings (range 1–9)
Secondary Coverage Delay Interval	2 rings (fixed)
Retry Timing Interval	5 seconds (fixed)

Operator

QCC Queue Priority for coverage group	4 (range 1–7)
QCC operator to receive calls for coverage group	Primary system operator

Description

Coverage allows a call ringing at one extension (a *sender*) to ring at another extension (a *receiver*) at the same time and to be answered at either extension. It is not necessary for the sender and receiver to have shared personal lines or

Shared SA buttons. A coverage sender, whose calls are covered, can be an individual extension (*Individual Coverage*) or a group of extensions (*Group Coverage*).

An extension becomes a sender and has its calls covered in *either* or *both* of the following ways:

- An Individual Cover button is programmed for the sender on the multiline telephone of a receiver.
- The sender is made a part of a coverage group through system programming. A receiver for the group is programmed in any of the following ways:
 - A Group Cover button is programmed for the group on a multiline telephone (a receiver).
 - The QCC queue is programmed to be a receiver for the group.
 - A calling group is programmed to be a receiver for the group (this option can be used to provide voice mail coverage for a coverage group).

An individual multiline telephone can have any combination of up to eight Individual Cover and Group Cover buttons.

Several timers, summarized in [Table 4 on page 174](#), affect the delivery of a call to coverage and/or how a covered call rings. In Release 4.1 and later systems, additional settings allow system managers to customize coverage delays on an extension-by-extension basis, rather than by specifying delay intervals for all extensions on the system. These extension timers replace the systemwide settings for Coverage Delay Interval and Delay Ring Interval. Explanations of these timers are included in the descriptions of Individual Coverage and Group Coverage later in this section.

Individual Coverage

An Individual Coverage receiver, who covers calls for a sender, has a programmed button that corresponds to the sender's extension. A given sender can have up to eight Individual Coverage receivers covering calls. A receiver, who must have a multiline telephone, can have separate buttons for up to eight senders, but can have only one button to provide Individual Coverage for a given sender.

A button for Individual Coverage can be programmed as either Primary Cover or Secondary Cover. The Secondary option provides a 2-ring delay, the Secondary Coverage Delay Interval, to allow the sender to answer before the receiver; in system releases prior to 4.1, the Primary option does not provide this delay.



NOTE:

You cannot program a button for Individual Coverage to cover calls for an extension located on another system.

In Release 4.1 and later systems, the system manager sets additional ring delays for each extension, rather than programming only systemwide settings. The Secondary Cover Ring Delay is applied in addition to the fixed systemwide Secondary Coverage Delay Interval; it does not affect Secondary or Group Coverage call delivery. The Primary Cover Ring Delay option also permits extension-by-extension control of ring delays on Primary Cover buttons programmed for Delay Ring. The Group Coverage Ring Delay option allows the system manager to control the delay before a given sender's covered calls are sent to Group Coverage receivers, whether or not Group and Individual Coverage are combined.

[Table 4](#) summarizes the systemwide and extension-by-extension (Release 4.1 and later systems only) settings that the system manager programs. In addition, a user or system manager can program Cover buttons with Ring Timing options: Immediate Ring, Delay Ring, or No Ring (see [Table 5](#)).

Table 4. Ring Delays Affecting Coverage

Timer	Factory Setting	Range	Description
Coverage Delay Interval ¹	3 rings	1–9 rings	Release 4.0 and prior systems, set systemwide. Delay before sending calls to Group coverage when: <ul style="list-style-type: none"> ■ Sender also has Individual Coverage and receiver is available. ■ Sender does not have Individual Coverage or receiver is not available, and Group Coverage receiver is calling group only or QCC queue only (no Group Cover buttons on multiline telephones).
Group Coverage Ring Delay	3 rings	1–9 rings	Release 4.1 and later systems, programmable for each extension. Delay before sending calls to Group Coverage when: <ul style="list-style-type: none"> ■ Sender has Individual Coverage and receiver is available (in addition to Primary Cover Ring Delay). ■ Sender does not have Individual Coverage or receiver is not available, and Group Coverage receiver is calling group only or QCC queue only (no Group cover buttons on multiline telephones).

Table 4. Ring Delays Affecting Coverage — Continued

Timer	Factory Setting	Range	Description
Primary Cover Ring Delay	2 rings	1–6 rings	Release 4.1 and later systems, programmable for each extension. This timer sets: <ul style="list-style-type: none"> ■ The delay before a Primary Cover button programmed for Delay Ring begins to ring audibly. ■ The delay, in addition to the Group Coverage Ring Delay, before calls are sent to Group Coverage when the sender has Individual Coverage and any receiver is available.
Secondary Cover Ring Delay	2 rings	1–6 rings	Release 4.1 and later systems, programmable for each extension. In addition to the fixed Secondary Coverage Delay Interval (2 rings), this timer sets the delay before a Secondary Cover button programmed for Delay Ring begins to ring audibly. This setting does not affect Primary or Group Coverage call delivery.
Secondary Coverage Delay Interval	2 rings	Fixed	Delay before sending Individual Coverage calls to a Secondary Cover button programmed for Immediate Ring when sender also has Individual Coverage to a Primary Cover button. In Release 4.1 and later systems, the delay (in addition to the Secondary Cover Ring Delay setting for the sender) before a Secondary Cover button programmed for Delay Ring begins to ring audibly.
Retry Timing Interval	5 sec	Fixed	Repetition interval for trying to send calls to group coverage when no receivers are available; continues until call is answered by sender or receiver (or caller hangs up).

1 In Release 4.1 and later systems, this setting is replaced by the Group Coverage Ring Delay.

Ring Timing Options, summarized in [Table 5](#), are programmable on any buttons, including programmed Cover buttons on multiline telephones.

Table 5. Ring Timing Options

Option	Factory Setting	Range	Description
Immediate	—	—	—
Delay Ring	2 rings	1–6 rings on Cover buttons	Delay before sending calls to Group Coverage (in addition to Coverage Delay Interval) when sender also has Individual Coverage <i>and</i> receiver is available.
No Ring	—	—	On sender (covered) telephone, prevents calls from going to coverage.

Regardless of how these ringing options are programmed, the green LED next to the Cover button on the receiver's telephone flashes immediately when a call begins ringing at the sender's telephone. The receiver's telephone rings audibly, as shown in [Table 6](#). Both telephones continue to ring as programmed. The green LED on both telephones continues to flash until the call is answered either by the sender or by the receiver or the caller hangs up.

Table 6. Ringing on Individual Coverage (Receiver) Buttons

Ringling Option	Primary Cover	Secondary Cover
Immediate Ring	Immediately	After sender's telephone rings 2 times (SC, fixed)
Delay Ring	After sender's telephone rings 1–6 (PRD or DR) times	After sender's telephone rings 2 times (SC) + 1–6 (PRD or DR) times
No Ring	Does not ring	Does not ring

Where:

PRD = Primary Cover Ring Delay (Release 4.1 and later systems)

DR = Delay Ring Interval (Release 4.0 and prior systems)

SC = Secondary Coverage Delay Interval

Group Coverage

Up to 30 coverage groups can be programmed for the system. Group Coverage is an arrangement in which senders are organized into *coverage groups*, and calls received by any unavailable group member are sent to one or more receivers. There is no limit to the number of members in a group, but a given extension can be a member of only one group. Any telephone except a QCC can be a member of a coverage group.

Three types of receivers can be assigned to cover calls for coverage groups:

- A multiline telephone can have a Group Cover button for a specific coverage group, assigned through either extension programming or centralized telephone programming. The button is usually labeled with the name of the group, for example, *Sales*. A given coverage group can send its calls to up to eight Group Cover buttons; all eight can be programmed on one multiline telephone or can be distributed on as many as eight telephones.

Each Group Cover button can be programmed for Immediate Ring, Delay Ring, or No Ring, as illustrated in [Table 6](#).

A single-line telephone cannot be programmed individually as a Group Coverage receiver. It can, however, be a member of a calling group that is a receiver.



NOTE:

You may not program a Group Cover button to receive call for a coverage group located on another system.

- The QCC queue can be assigned through system programming as a receiver for up to 30 coverage groups, with up to four QCC operators (the maximum allowed number of QCCs) assigned to receive calls for each coverage group. A QCC cannot have programmed Group Cover buttons. The QCC queue can be the only receiver or can be used in addition to Group Cover buttons on multiline telephones. If both are used, the QCC queue is not counted in the 8-receiver maximum for the group. Because QCC calls are queued, an operator cannot distinguish a coverage call from any other type.



NOTE:

A coverage group may not send its calls directly to a QCC on another system. However, the same result can be achieved in Release 6.1 or later (Hybrid/PBX mode only) systems by having the coverage group send calls to a local calling group whose sole member is a remote QCC or remote Listed Directory Number (LDN) extension.

- A calling group can be assigned, through system programming, as a receiver for up to 30 coverage groups.

When a calling group is programmed as a receiver for a coverage group, a call to a coverage group member enters the calling group queue and waits for an available calling group member. When the call rings at an available member's telephone, it stops ringing at the sender's telephone and the sender's green LED turns off. Because calling group calls are queued, a calling group member cannot distinguish a coverage call from any other type.

Group Coverage by a calling group is used to provide coverage by a voice messaging system (VMS).

**NOTE:**

A coverage group may not send its call directly to a calling group on another system. However, the same result can be achieved in Release 6.1 or later (Hybrid/PBX mode only) systems by having the station send calls to a local calling group whose sole member is a remote calling group extension.

In Release 4.1 and later systems, the system manager can control the delay before calls are sent from each sender's extension to Group Coverage receivers. When Individual and Group Coverage are combined, the Primary Cover Ring Delay controls the interaction between Group and Individual Coverage for each extension. [Table 4 on page 174](#), summarizes the ways that these options work together as well as with fixed systemwide settings. Further information about interactions between Group and Individual Coverage is included later in this section, in the topic ["Interaction of Individual and Group Coverage" on page 181](#).

**NOTE:**

If a calling group is assigned to take calls for a coverage group, no other types of receivers—multiline telephones with Group Cover buttons nor the QCC queue—can be assigned for that coverage group.

Selective Coverage

When an extension has calls covered, all of its eligible calls are covered unless the sender uses one of the following coverage options:

- **Coverage Off** turns off all coverage. (If a Group Coverage sender uses Coverage Off, other telephone users can use Group Pickup to answer the sender's calls; however, they cannot use Individual Pickup.)

To turn coverage off or on, the sender must have a programmed Coverage Off button.

- **Coverage Inside** prevents or allows coverage of inside calls:
 - With Coverage Inside Off, only outside calls are covered, including calls from another system in the network.
 - With Coverage Inside On, inside and outside calls are covered.

To use Coverage Inside Off/On, the sender must use the programming code or select it from the display of a display telephone (using `ListFeature`) in extension programming. It cannot be programmed on a button.

- **Coverage VMS Off** prevents outside calls and private network calls from being sent to voice mail. With Coverage VMS Off, only inside calls are covered by the assigned voice mail system calling group. Outside calls go to any other points of coverage. Coverage VMS Off is available only in Release 2.0 and later systems. To use this feature, the sender must have a programmed Coverage VMS Off button.

In Release 4.1 and later systems, the system manager can set the Night Service feature to control the active/inactive status of programmed Coverage VMS Off buttons at extensions in a Night Service group. When the system is put into Night Service operation, all Coverage VMS Off buttons are automatically deactivated, so that the assigned VMS calling group can cover eligible calls with the normal ringing delay. When normal business-hours operation resumes and Night Service operation ceases, the programmed Coverage VMS Off buttons are automatically turned on; inside calls are sent to voice mail, and outside calls go to any other coverage receivers.

A user at an extension can override Night Service control of Coverage VMS Off buttons by pressing the Coverage VMS Off button at the extension. At the next transition into or out of Night Service, however, the Coverage VMS Off button follows Night Service status (inactive during Night Service operation, active during normal business-hours operation). Consider the following example where a Coverage VMS Off button has been manually pressed when Night Service with Coverage Control goes on (see [“Night Service” on page 458](#) for more information):

- If the Coverage VMS Off button is active and lit, the Night Service with Coverage Control option turns it off.
 - If the Coverage VMS Off button is already inactive and unlit, it remains so.
- **Do Not Disturb.** Calls go to coverage, if programmed.



NOTE:

In Release 6.0 and later systems (Hybrid/PBX mode only), non-local UDP calls are treated as outside calls by the system and by Selective Coverage features: Coverage Off, Coverage Inside, and Coverage VMS off.

Eligibility for Coverage

Not all calls are eligible for coverage. Eligibility is determined by the type of call and by how the sender's telephone is set up. [Table 7](#) shows which calls at the sender's telephone are eligible for coverage.

Table 7. Calls Eligible and Calls Ineligible for Coverage

Call Rings on	Eligible	Ineligible
SA or ICOM button programmed for Immediate or Delay Ring		
Inside calls	✓	
DID trunk calls	✓	
Inside or outside transferred calls	✓	
Calls forwarded from another extension		✓
Calls on Shared SA buttons		✓
Calls on Cover buttons		✓
Voice-announced calls		✓
Transfer return calls		✓
Returning parked calls		✓
Reminder service calls		✓
Personal line button programmed for Immediate or Delay Ring		
Sender is principal user	✓	
Someone else is principal user		✓
No principal user is assigned	✓	
Pool button programmed for Immediate or Delay Ring	✓	
Any button programmed for No Ring		✓



NOTES:

- In Release 2.0 and later systems, when a coverage receiver calls a coverage sender, the call can be sent to coverage. If a receiver calls a sender for whom he or she is covering and the sender is busy or unavailable, the call proceeds to other points of coverage. It does not come back to the receiver who originated the call.
- In Release 1.0 and 1.1 systems, a call from a receiver to a sender is not sent to coverage.

- If a sender sets the Ring Timing option for No Ring on any personal line, Pool, SA, or ICOM buttons, calls arriving on those buttons do not go to coverage.

Interaction of Individual and Group Coverage

Group Coverage can be used alone or with Primary and/or Secondary Individual Coverage. When both Individual Coverage and Group Coverage are used, the interactions between them follow this principle: If possible, a caller should always get personal attention from someone with a Cover button for the sender—going first to an Individual Coverage receiver, then to a multiline telephone with a Group Cover button. In these cases, the receiver can answer with either the name of the individual or the name of the group for whom he or she is covering. Only when these types of receivers are unavailable or not programmed does the call go to another, more impersonal type of Group Coverage—either the QCC queue or a calling group (including a voice messaging system calling group).

A call to a sender that is also ringing on Primary Cover, Secondary Cover, and/or Group Cover buttons rings until answered (or the caller hangs up). When the call is answered, the ringing and flashing green LED are removed from all other telephones providing coverage for the sender. When a calling group is programmed as the receiver for a coverage group, however, the ringing and flashing green LED are removed from the sender's telephone as the call leaves the calling group queue and is sent to an available calling group member. (A call on a personal line button on the sender's telephone is an exception. The ringing and flashing green LED remain on that button until answered, either by the sender or by a receiver.)



NOTE:

The duration of the ringback heard by an outside caller is shorter than the actual ring heard at an MLX, ETR, MLS, or analog multiline telephone. An outside caller, therefore, hears one or two rings and may also hear the number of rings programmed for the Coverage Delay Interval plus the number of rings programmed for the Delay Ring Interval. For example, if the Coverage Delay Interval is programmed for one ring and the Delay Ring interval is programmed for two rings, an outside caller hears four rings before the call begins ringing at receivers' telephones. If both intervals are set to their maximum values, the caller can hear up to two additional rings.

A call goes to Group Coverage depending on the following conditions:

- Whether the sender is available or unavailable.
- Whether the sender has Individual Coverage (Primary Cover or Secondary Cover buttons programmed on other extensions) and, if so, whether an Individual Coverage receiver is available.

- The type of Group Coverage receivers programmed:
 - Only Group Cover buttons on multiline telephones.
 - Both Group Cover buttons and the QCC queue.
 - Only the QCC queue.
 - Only a calling group.
- In Release 4.1 and later systems, the Group Coverage Ring Delay is set for each sender's extension. When Group Coverage is used in conjunction with Individual Coverage, calls should ring at receivers for Individual Coverage first. Consider the following factors before setting the Group Coverage Ring Delay for an extension:
 - If a sender has only Primary Coverage and any receiver's Primary Cover buttons are set to Delay Ring, the value for the Group Coverage Ring Delay should be higher than the Primary Cover Ring Delay value for each sender.
 - If a sender has both Primary and Secondary Coverage and all the receivers' Cover buttons are set for Immediate Ring, the Group Coverage Ring Delay should be set higher than the Primary Cover Ring Delay or the 2-ring fixed Secondary Cover Delay Interval.
 - If both Primary and Secondary Cover buttons are programmed for a sender and any receiver's Primary and/or Secondary Cover buttons are programmed for Delay Ring, the value should be higher than whichever of the following is greater:
 - Primary Cover Ring Delay.
 - Fixed Secondary Cover Delay Interval (two rings) plus the Secondary Cover Ring Delay.
- In Release 4.1 and later systems, the system manager uses system programming to set a Primary Cover Ring Delay (1–6 rings) for each sender.
- In releases prior to 4.1, a systemwide value is set for the Coverage Delay Interval through system programming (1–9 rings). When used in combination with Delay Ring, this value should be higher than the Delay Ring Interval.

**NOTE:**

In releases prior to 4.1, the value set for the Delay Ring Interval (1–6 rings) through system programming affects Individual Coverage only. This setting is replaced in Release 4.1 and later systems.

A sender is considered unavailable (his or her telephone does not ring) under the following conditions:

- The sender has turned on Do Not Disturb.
- All SA or ICOM buttons are in use on the sender's telephone.
- The sender is using extension programming or testing the telephone.
- The sender has an MLX display telephone and is using an Alarm Clock or Directory feature.
- The sender's telephone is forced idle for system programming or centralized telephone programming.
- The sender's telephone is not responding (for example, it is not connected).
- The sender has activated Remote Call Forwarding.

A receiver is considered unavailable (his or her telephone does not ring) under the following conditions:

- The receiver has turned on Do Not Disturb. (In this case, the sender can call the receiver.)
- Another call is ringing or answered on the receiver's Cover button for that sender.
- The receiver is in extension programming or is testing the telephone.
- The receiver with an MLX display telephone is using the Alarm Clock or Directory feature.
- The receiver's telephone is forced idle for system programming or centralized telephone programming.
- The receiver's telephone is not responding (for example, it is not connected).

If a call is sent to Group Coverage and no receiver is available, the system continues trying to send the call every five seconds until a Group Coverage receiver becomes available. This repeated attempt to send the call is called *retry timing*. The 5-second retry timing interval cannot be changed.

**NOTE:**

In Release 6.0 and later systems (Hybrid/PBX mode only), calls arriving at one system cannot be covered by extensions or calling groups on a remote system.

[Table 9 on page 185](#) shows when a call goes to Group Coverage receivers in Release 4.1 and later systems. [Table 8 on page 184](#) shows when a call goes to

Group Coverage receivers in Release 4.0 and prior systems. In both tables, the rules for sending calls to Group Coverage apply *after* the calls first go to any available Individual Coverage receivers (as described in [Table 6 on page 176](#)).

See [Figure 7 on page 187](#) and [Figure 8 on page 188](#) for examples of LED and ringing patterns in Release 4.1 and later systems and in Release 4.0 and prior systems. [Figure 6](#) and [Figure 7](#) show examples of what happens when only Group Coverage is used or when all Individual Coverage receivers are unavailable. [Figure 8](#) and [Figure 9](#) show examples of what happens when both Individual Coverage (Primary and Secondary) and Group Coverage are programmed for an individual sender.

Table 8. Group Coverage Call delivery Rules (Release 4.1 and Later Systems)

Receiver Type	Sender Status	Primary Coverage Receiver Status	Secondary Coverage Receiver Status	Sent to Group Coverage after
Group Cover button(s) only, or Group Cover button(s) and QCC queue	Available	Available	Available	GCD + PRD
			Unavailable or unassigned	GCD + PRD
		Unavailable or unassigned	Available	GCD + PRD
			Unavailable or unassigned	Immediate
	Unavailable	Available	Available	GCD + PRD
			Unavailable or unassigned	GCD + PRD
		Unavailable or unassigned	Available	GCD + PRD
			Unavailable or unassigned	Immediate
QCC Queue only	Available	Available	Available	GCD + PRD
			Unavailable or unassigned	GCD + PRD
		Unavailable or unassigned	Available	GCD + PRD
			Unavailable or unassigned	GCD
	Unavailable	Available	Available	GCD + PRD
			Unavailable or unassigned	GCD + PRD
		Unavailable or unassigned	Available	GCD + PRD
			Unavailable or unassigned	Immediate
Calling group only	Available	Available	Available	GCD + PRD
			Unavailable or unassigned	GCD + PRD
		Unavailable or unassigned	Available	GCD + PRD
			Unavailable or unassigned	GCD

Table 8. Group Coverage Call delivery Rules (Release 4.1 and Later Systems) — Continued

Receiver Type	Sender Status	Primary Coverage Receiver Status	Secondary Coverage Receiver Status	Sent to Group Coverage after
	Unavailable	Available	Available	GCD + PRD
			Unavailable or unassigned	GCD + PRD
		Unavailable or unassigned	Available	GCD + PRD
			Unavailable or unassigned	Immediate

Where:

GCD = Group Coverage Ring Delay

PRD = Primary Cover Ring Delay

Table 9. Group Coverage Call Delivery Rules (Release 4.0 and Prior Systems)

Receiver Type	Sender Status	Individual Coverage Receiver Status	Call Delivered to Group Coverage after...
Group Cover button(s) only or Group Cover button(s) and QCC queue	Available	Available Unavailable or unassigned	CD + DR ¹ Immediate ¹
	Unavailable	Available Unavailable or unassigned	CD + DR ¹ Immediate ¹
QCC Queue only or Calling group only	Available	Available Unavailable or unassigned	CD + DR ¹ CD
	Unavailable	Available Unavailable or unassigned	CD + DR ¹ Immediate ¹

¹ Ringing is delayed an additional DR after the green LED turns on at a Group Cover button programmed for Delay Ring on a multiline telephone.

Where:

GD = Coverage delay interval

DR = Delay Ring interval

Settings:
 Primary Cover Ring Delay = 2 rings
 Secondary Cover Ring Delay = 2 rings
 Group Coverage Ring Delay = 3 rings
 Sender is available

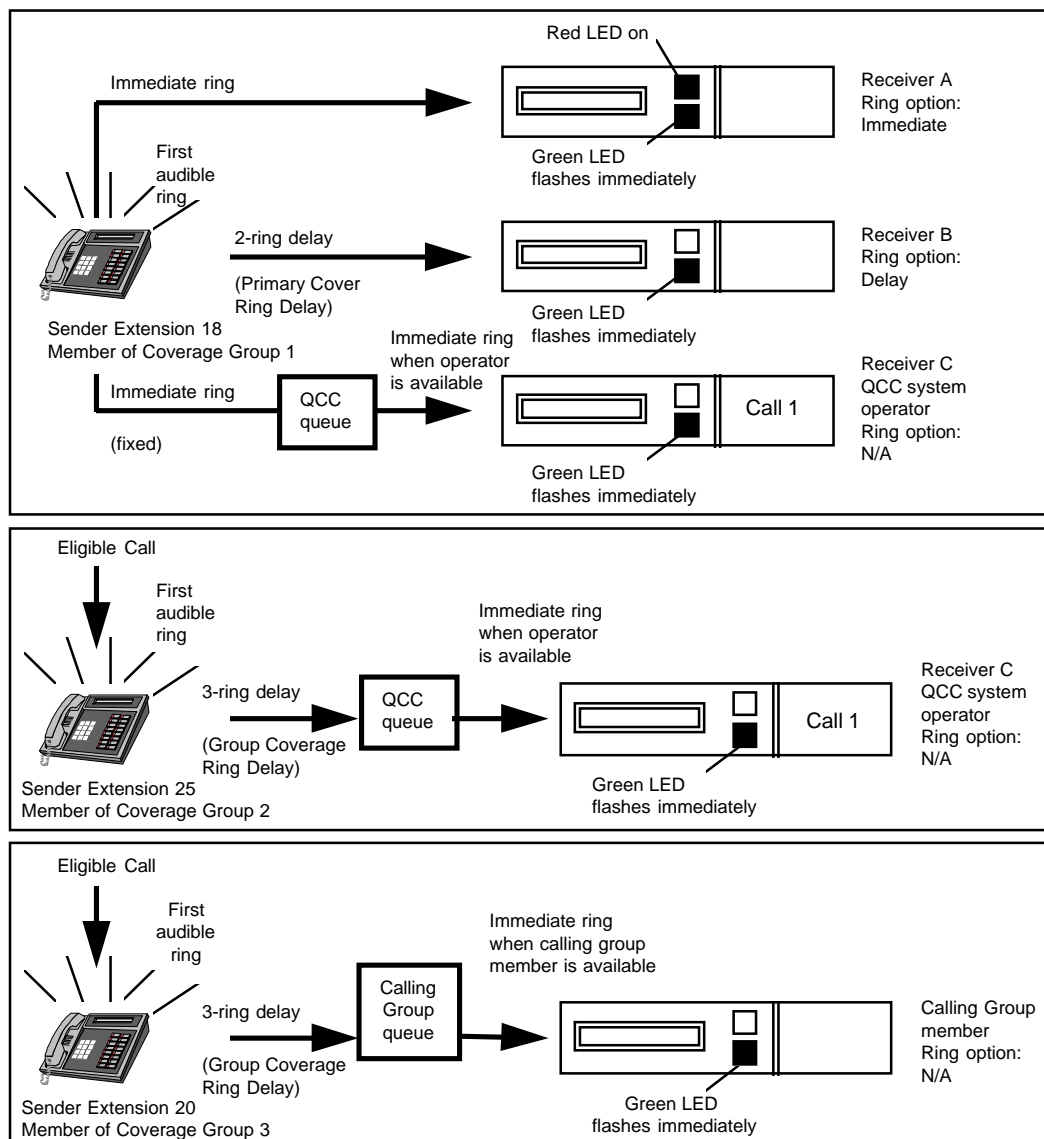

Figure 6. Group Coverage Only or All Individual Coverage Receivers Unavailable (Release 4.1 and Later Systems Only)

Settings:
 Delay Ring Interval = 2 rings
 Secondary Delay Interval = 3 rings

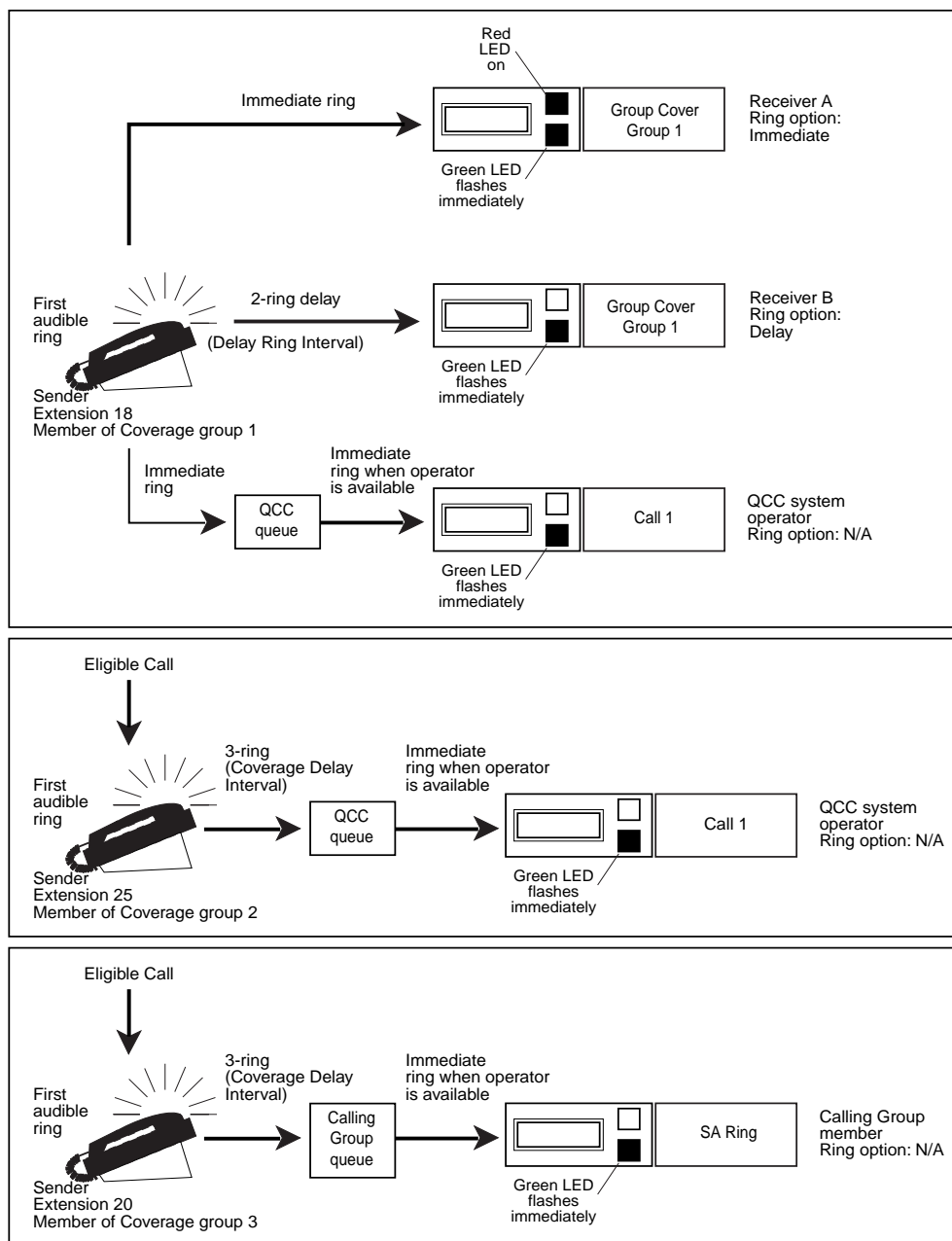

Figure 7. Group Coverage Only or All Individual Coverage Receivers Unavailable (Release 4.0 and Prior Systems)

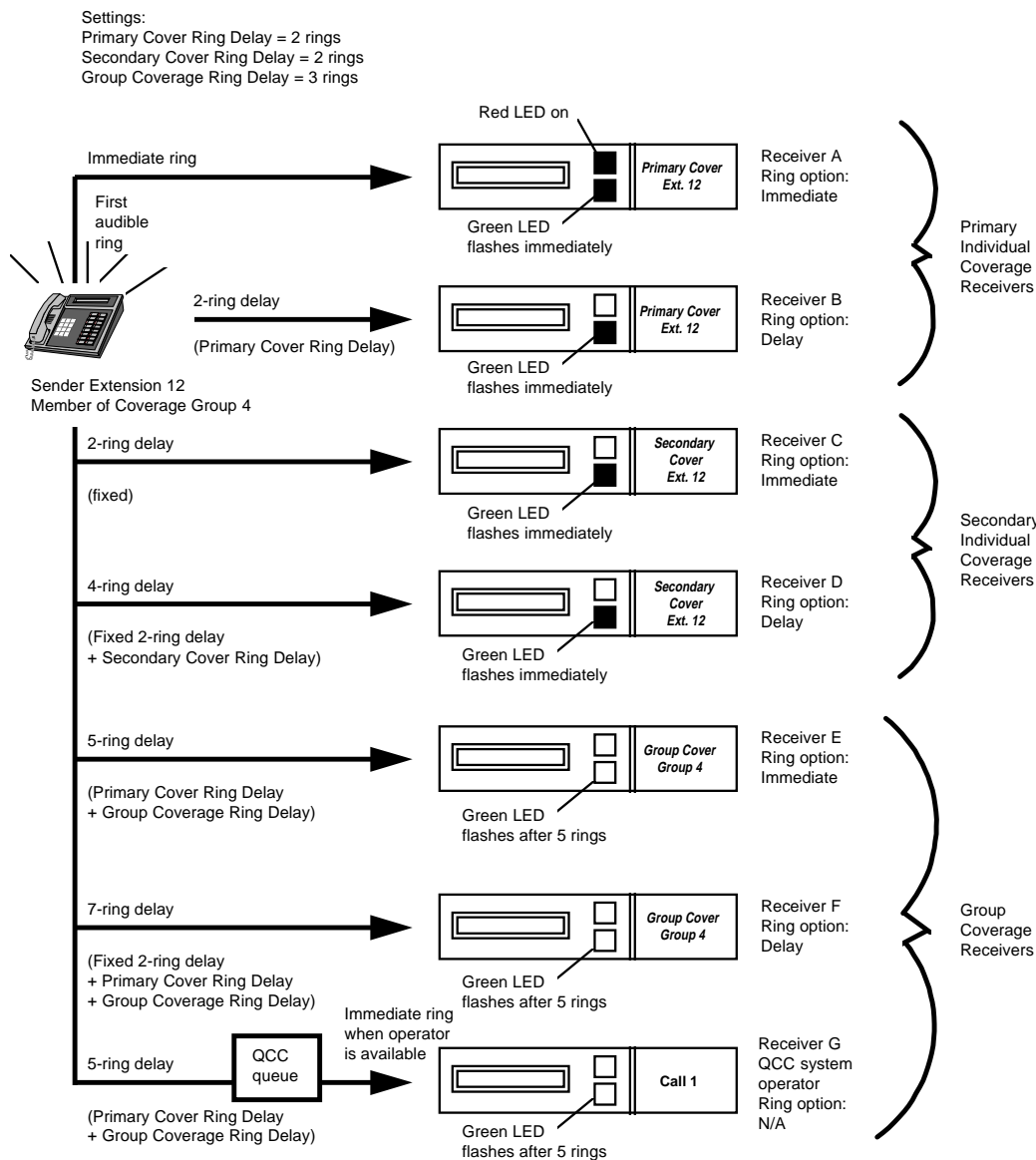

Figure 8. Individual (Primary and Secondary) and Group Coverage Ringing Patterns (Release 4.1 and Later Systems Only)

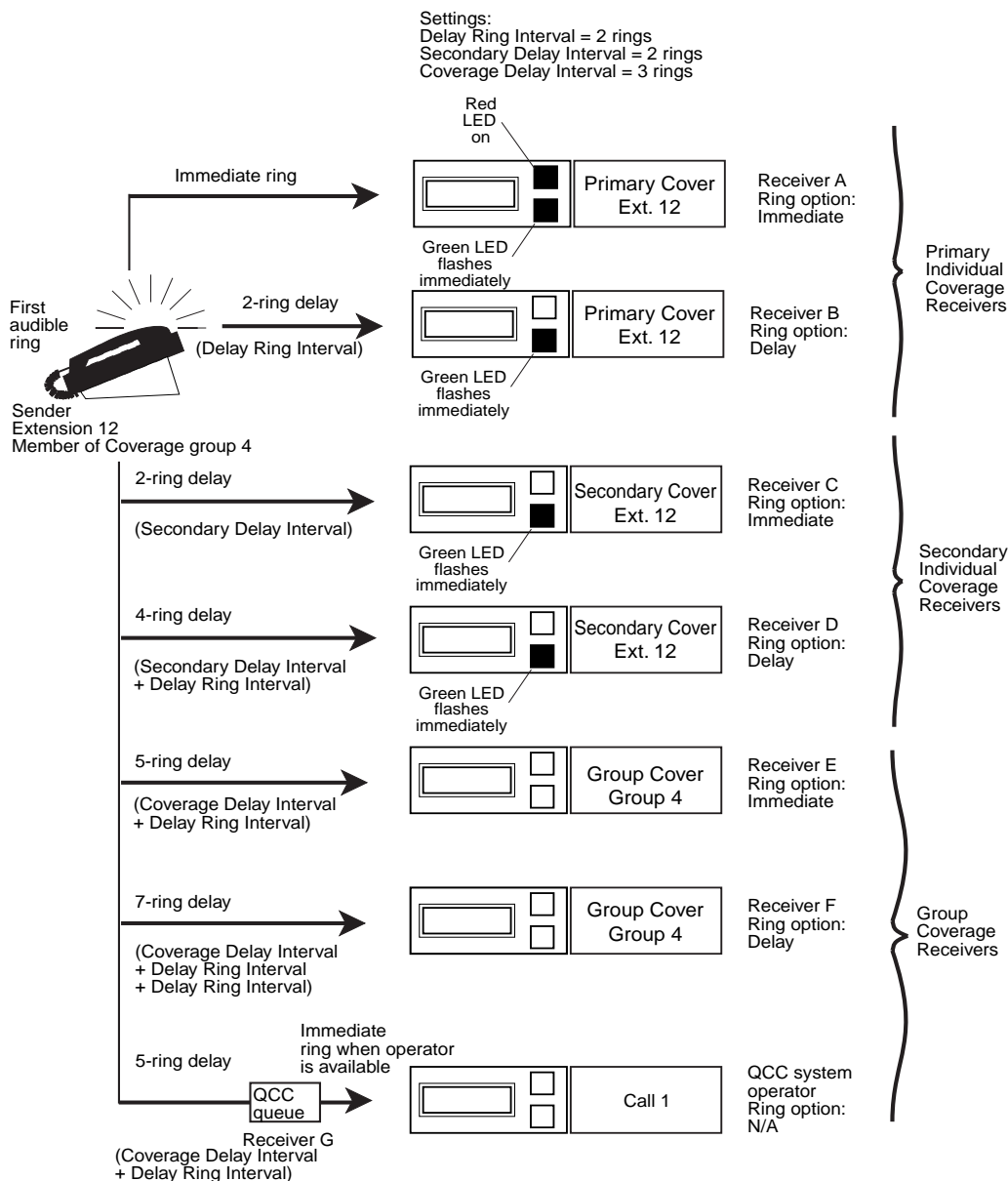

Figure 9. Individual (Primary and Secondary) and Group Coverage Ringing Patterns (Release 4.0 and Prior Systems)

Cover to Voice Mail with Escape to System Operator

When DID or an Auto Attendant is used, users receive calls directly, without the intervention of an operator. In these situations, the telephone should have voice mail coverage instead of coverage by a receptionist (operator). The caller then has the option to leave a message or press 0 in order to talk to the receptionist. If after talking to the receptionist, the caller wants to leave a message, the receptionist can transfer the call back to voice mail using the Direct Voice Mail (DVM) feature.

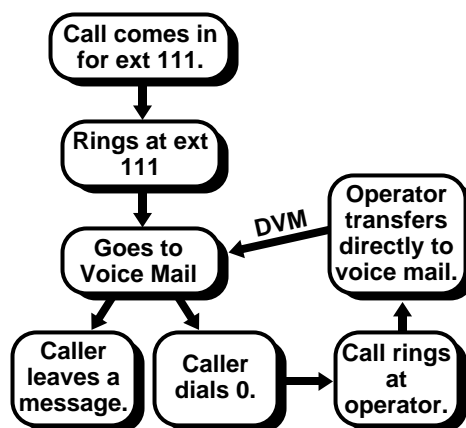

Figure 10. Cover to Voice Mail with Escape to System Operator

This configuration is usually the best solution for coverage to voice mail because of the following advantages:

- Reduces the burden on the receptionist or operator.
- Allows the caller to make the choice whether to leave a message or speak to an operator.
- Allows the caller to leave a message without waiting for the receptionist.

Cover to System Operator before Voice Mail

If calls must go to a receptionist, coverage can be set up using one of the following methods:

- Primary Coverage (eight or fewer extensions).
- Phantom calling groups (30 or fewer extensions).
- Phantom extensions (30 or more extensions)

Primary Coverage

If eight or fewer extensions require coverage to the system operator, use delayed Primary Coverage or Secondary Coverage to allow calls to be covered by the operator. When a caller dials the user's number, the call is covered by the operator, and the operator can then send the call to voice mail using the Direct Voice Mail feature. If the operator does not answer, the call may or may not go to coverage, depending on the status of the user's Coverage VMS Off button. If the Coverage VMS Off button is not selected (the light is off), the call goes to voice mail. If the Coverage VMS Off button is selected (the light is on), the call continues to ring at the extension.

To set up Primary Coverage to the operator before going to voice mail, do the following:

1. Assign an extension to a coverage group. Assign the coverage group to calling group 770 (voice mail).
2. Program a Primary Cover button for the extension on the operator's Direct-Line Console. (A QCC cannot be used.) Set it for Delay Ring.
3. To keep calls from going to voice mail when the operator does not pick up, program a Coverage VMS Off button on the extension.

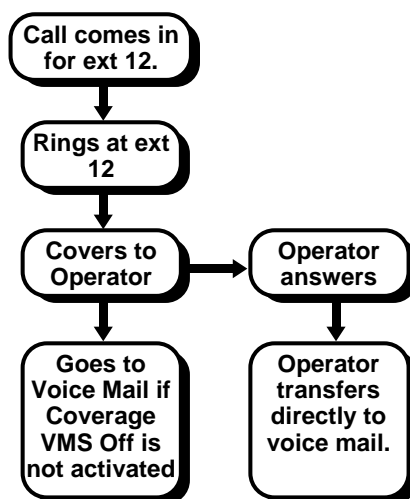

Figure 11. Primary Coverage

For example, consider how the primary coverage configuration works when a caller dials a DID number. The extension for the DID number (in [Figure 11](#), Extension 12) rings several times. If the telephone is not answered, an operator gets the call. If the operator fails to answer, the call either goes to voice mail or

keeps ringing, depending on the Coverage VMS Off status on the extension for the DID number. When the operator answers and the caller asks to leave a message, the operator uses Direct Voice Mail to transfer the caller to the extension's voice mail. The caller leaves a message, and the extension's message LED goes on.

Phantom Calling Groups

If fewer than 30 extensions require coverage to the main operator, phantom calling groups can be used to provide a second extension number for each user's voice mail. The actual extension covers to the operator (Group Coverage), and the calling group covers to voice mail. When someone dials the user's number, the call covers to the operator, who can then transfer the call to the voice mail extension.

To set up phantom coverage to the operator before voice mail coverage, do the following:

1. Assign an extension to a coverage group. (In [Figure 12](#) the extension is 101.) Assign a Group Cover button to the operator (if a DLC), or assign the coverage group to ring at the QCC.
2. Renumber a calling group to a number that is easy to associate with the sender extension. (For example, change 771 to 201. You may have to renumber an existing 201 first.)
3. Assign the calling group to overflow to calling group 770 (voice mail) with a threshold of 1. (In [Figure 12](#), the calling group extension is 201.) Assign 101 as the message receiver for calling group 770.

With the phantom calling groups coverage configuration, a caller dials a DID number (for example 555-5101). The extension for the DID number (in the example, Extension 101) rings several times. If the telephone is not answered, the call is covered by an operator. The operator answers the call, and the caller asks to leave a message. The operator transfers the call to 201, and the call goes to voice mail. The Message light goes on at the extension for the DID number (in the example, 101).



NOTE:

A user can give out a regular telephone number (555-5101) and a voice mail number (555-5201). This way, callers can leave a message without ringing the telephone. This is necessary to receive messages outside of office hours. Callers cannot leave messages after hours unless they know the second DID number.

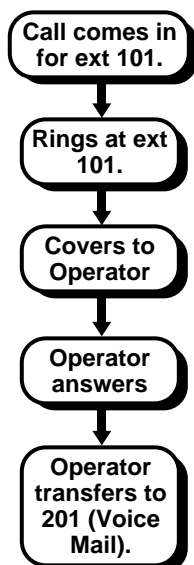

Figure 12. Phantom Calling Groups

Phantom Extensions

If more than 30 extensions require coverage to the operator, phantom extensions can be used after the maximum number of phantom calling groups is reached. This setup is slightly different from the previous two scenarios. In this case, the published DID number is the number for the phantom extension. The actual telephone has Shared SA buttons with the phantom extension as principal user, so the call rings at the telephone with the SSA button. The operator covers the phantom extension and can use the Direct Voice Mail feature to send calls to the original extension's voice mail.

To set up phantom coverage to the operator before going to voice mail, do the following (see [Figure 13](#)):

1. Assign the extension to a coverage group. Assign a Group Cover button to the operator if the operator is a DLC, or assign the coverage group to ring at the QCC.
2. Assign a phantom extension to a number (in [Figure 13 on page 194](#)). You may have to renumber the extension first. If the extension does not have an adjunct, using the adjunct extension number helps avoid confusion. (see ["System Renumbering" on page 685](#) for details about adjunct extension numbers.)

3. Assign Shared SA buttons for the phantom extension to the real extension. (In [Figure 13](#), SSA buttons for 214 were assigned to 114.) Remove all but one SA button for the real extension. You may want to make this a No Ring button and move it to a virtual button that is not actually on the physical telephone. This conserves buttons and prevents accidental calls to 114 from ringing at the extension.
4. Assign the extension (in [Figure 13](#), Extension 114) to coverage group 1. Assign coverage group 1 to the voice-mail calling group, 770.

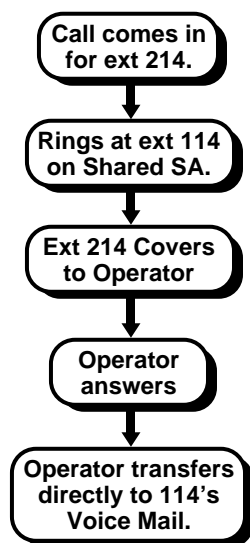

Figure 13. Phantom Extensions

Consider how the phantom extensions coverage configuration works when a caller dials the DID number—for example, 555-5214. Extension 114 rings several times on a Shared SA button. If the call is not answered, it is covered by an operator, and the display shows *Cover ext 214*. The operator answers the call and the caller asks to leave a message. The operator transfers the caller to the extension's voice mail, Extension 114, using Direct Voice Mail. The caller leaves a message for the person at the extension, and the Message light goes on.



NOTE:

A user can give out a regular telephone number (in this example, 555-5214) and a voice mail number (555-5114). This way, callers can leave a message without ringing the telephone. This is necessary to receive messages outside of office hours. Callers cannot leave messages after hours unless they know the second DID number.

Cover to Personal Secretary before Voice Mail

If you need coverage by a personal secretary who is not a system operator at an operator console, then Primary Coverage can be used on the secretary's telephone. The secretary can use Direct Voice Mail to transfer the call back to the user's voice mail. If the secretary is out, calls can either continue to ring or go to voice mail, depending on the status of the user's Coverage VMS Off button.

To set up Primary Coverage to a personal secretary before going to voice mail, do the following:

1. Assign the extension to a coverage group. Assign the coverage group to calling group 770 (voice mail).
2. Program a Primary Cover button for the extension on the secretary's telephone. Program it for Delay Ring.
3. If you want to keep calls from going to voice mail when the secretary does not pick up, program a Coverage VMS Off button on the extension.

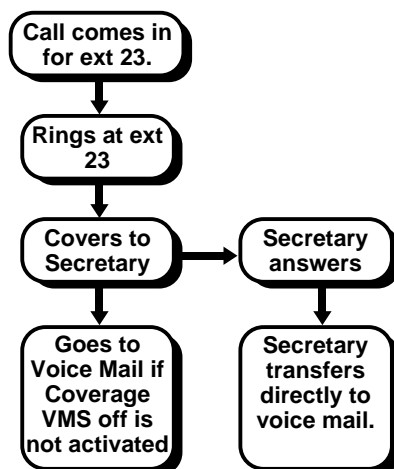

Figure 14. Coverage and Direct Voice Mail

A caller dials the DID number. Extension 23 rings several times. The covering secretary answers, and the caller asks to leave a message. The secretary uses the Direct Voice Mail feature to transfer the call to the extension's voice mail. The caller leaves a message, and the extension's Message light goes on. If the operator fails to answer, the call either goes to voice mail or keeps ringing, depending on the Coverage VMS Off status at the extension for the DID number.

Considerations and Constraints

In Release 2.0 and later systems, if a receiver calls a sender for whom he or she is covering and the sender is busy or unavailable, the call proceeds to other points of coverage. It does not come back to the receiver who originated the call. In Release 1.0 and 1.1 systems, a call from a receiver to a sender is not covered.

A maximum of eight Primary Cover and Secondary Cover buttons can be assigned to provide Individual Coverage for a given sender. Only one Cover button for each sender can be programmed on a multiline telephone.

A maximum of eight Group Cover buttons can be assigned to provide Group Coverage for each coverage group. All eight can be programmed on one multiline telephone, or the Group Cover buttons can be distributed on as many as eight multiline telephones.

A receiver with a multiline telephone can have as many as eight Cover buttons, which can be programmed for any combination of Group and Individual Coverage.

If a receiver has both a Primary Cover or Secondary Cover button for a sender and a Group Cover button for the group of which the sender is a member, a call for the sender rings only at the receiver's Primary Cover or Secondary Cover button. This prevents multiple deliveries of the same call to the same receiver.

Each coverage group can have any number of members, from none to all the extensions in the system.

Each sender can be a member of only one coverage group.

If a sender without Individual Coverage is a member of a coverage group and no receivers are assigned for the group, a caller hears ringback instead of a busy tone when the sender is unavailable.

If a calling group is assigned as a receiver for a coverage group, it is the only receiver for that group; no other types of Group Coverage receivers can be programmed. Individual members of the coverage group, however, can be senders to Individual Coverage receivers.

A calling group can be a receiver for up to 30 coverage groups.

A receiver with a Group Cover button can also be a member of the coverage group for which the button is programmed. Calls to that receiver are sent to all other receivers programmed for the group.

When both the QCC queue and multiline telephones are programmed as receivers for a coverage group, the QCC queue is not counted in the 8-receiver maximum for the group.

A QCC cannot be a coverage sender.

When Group Coverage is the only type of coverage programmed for a sender, the QCC queue should not be programmed along with Group Cover buttons on multiline telephones. Because the QCC cannot be programmed for Delay Ring, eligible calls ring immediately both at the sender's telephone and at the QCC queue. This may not allow the sender enough time to answer the call before a QCC operator answers.

If a call is sent to coverage because the sender does not have a button available to take the call, the call does not return to the sender's telephone, even if a button becomes available while the call is ringing at a coverage receiver's telephone.

An inside voice-announced call made on an SA Voice or ICOM Voice is not covered. If it is converted to a ringing call—for example, because the sender's speakerphone is in use—the ringing call is sent to coverage.

No type of Cover button can be used to make calls.

When the sender also has Individual Coverage and an Individual Coverage receiver is available, the Delay Ring interval is used as a delay in addition to the Coverage Delay Interval before a call goes to Group Coverage.

In Release 6.0 and later systems (Hybrid/PBX mode only), non-local UDP calls are treated as outside calls by the system and by Selective Coverage features: Coverage Off, Coverage Inside, and Coverage VMS Off.

When no principal user is assigned for a personal line, calls received on the personal line cannot be forwarded to outside telephone numbers. Calls follow the Individual Coverage patterns of all senders who share the line and the Group Coverage pattern of the extension with the lowest logical identification number (lowest numbered jack on the module).

In Release 4.1 and later systems, coverage delay settings affect the ability of Integrated Administration to program some Coverage options for AUDIX Voice Power.

In Release 4.1 and later systems only, Night Service Coverage Control, when enabled through system programming (factory setting is Disabled), controls VMS coverage only and has no effect on Individual Coverage (Primary or Secondary) or on other types of Group Coverage. When disabled, the feature has no effect whatsoever on coverage.

In Release 4.1 and later systems only, in a system with Night Service Coverage Control enabled, Night Service transitions do not toggle the programmed Coverage VMS Off button to the opposite status. Instead, when Night Service goes on or off after a user has manually pressed the button, the button follows

Night Service status just as other programmed Coverage VMS Off buttons do. The status of programmed Coverage VMS Off buttons is always set to match the *most recent* user press or transition into or out of Night Service operation. For more information about Night Service, see [“Night Service” on page 458](#).

Telephone Differences

Direct-Line Consoles

A DLC can be both an Individual or Group Coverage receiver and a member of a coverage group.

Queued Call Consoles

The QCC cannot be a sender for either Individual or Group Coverage. The QCC queue can be a Group Coverage receiver for up to 30 coverage groups. Because Cover buttons cannot be programmed on the QCC, the queue is not counted in the 8-receiver maximum allowed for each coverage group. The QCC cannot be an Individual Coverage receiver.

The QCC queue priority and the individual QCC operator who receives calls for each coverage group are assigned independently for each group.

If a line/trunk is programmed to ring in the QCC queue and also is assigned as a personal line on a telephone that is a member of a coverage group covered by the QCC queue, a call on that line/trunk does not appear as a coverage call at the QCC.

If Group Cover buttons are programmed for a coverage group in addition to the QCC queue, and all QCC operators are in Position-Busy mode, a Group Coverage call goes to all receivers except the QCC queue.

When Group Coverage is the only type of coverage programmed for a sender, the QCC queue should not be programmed in addition to Group Cover buttons on multiline telephones. Because the QCC cannot be programmed for Delay Ring, eligible calls ring immediately both at the sender's telephone and at the QCC queue. This may not allow the sender enough time to answer the call before a QCC operator answers.

When the QCC queue is assigned as a receiver for a coverage group and a call transferred to a group member is not answered, the call returns to the queue as follows:

- If the QCC return ring interval is shorter than the Coverage Delay Interval (releases prior to 4.1) or the Group Coverage Delay setting (Release 4.1 and later systems), the call returns as a returning transfer call.

- If the QCC return ring interval is longer than the Coverage Delay Interval (releases prior to 4.1) or the Group Coverage Delay setting (Release 4.1 and later systems), the call returns as a Group Coverage call.

Other Multiline Telephones

Any type of multiline telephone can be a sender and/or receiver for either Individual Coverage or Group Coverage and can have up to eight Cover buttons.

Single-Line Telephones

A single-line telephone can be a sender for either Individual or Group Coverage. A single-line telephone can be a receiver for Individual Coverage. It can be a receiver for Group Coverage only when it is a member of a calling group assigned as a receiver for a coverage group.

Transferred calls to a busy single-line telephone are not eligible for coverage unless Coverage Inside is on. A transferred call to a busy single-line telephone with Group Coverage and Coverage Inside off camps on at the single-line telephone and returns to the originator, if not answered before the transfer return interval expires.

Feature Interactions

Account Code Entry	<p>When answering calls on a programmed Primary Cover, Secondary Cover, or Group Cover button, a receiver cannot enter an account code. When attempting to enter an account code, the receiver hears no error tone, but the account code does not appear on the SMDR report.</p> <p>Because Cover buttons are not required when the QCC queue is assigned as a receiver for a coverage group, a QCC operator can enter an account code, and the account code appears on the SMDR printout.</p>
Auto Answer All	<p>A sender or receiver at an analog multiline telephone can use Auto Answer All to have calls answered by an answering machine connected to the telephone.</p>
Auto Answer Intercom	<p>Auto Answer Intercom prevents a receiver on an analog multiline telephone from using a Hands-Free Unit (HFU) to answer calls received on a Primary Cover, Secondary Cover, or Group Cover button.</p>
Automatic Line Selection	<p>When Ringing/Idle Line Preference is on for an extension, the system automatically selects a Primary Cover, Secondary Cover, or Group Cover button with a ringing call. These buttons cannot be programmed in an ALS sequence, however, because they cannot be used to make calls.</p>

Barge-In	Barge-In can be used to join an Individual or Group Coverage call answered at any receiver extension, but not at a VMI port. VMI ports always have Privacy on. If an operator uses Barge-In to reach an extension with Coverage, however, the call from the operator is not directed to the receiver's extension.
Callback	The sender and all receivers must be busy before a call to a sender is eligible for Callback. The call is sent to coverage before it is put in the callback queue. Once a call is in the callback queue, it is not sent to coverage again. A callback call indicating that a busy extension or pool is now available is not sent to coverage.
Caller ID	Caller ID information is available to users receiving coverage calls.
Calling Restrictions	In Release 2.1 and later systems, users answering calls on Cover buttons can generate touch tones (for example, by dialing 1 to accept a collect call) if their telephones are not outward- or toll-restricted. If the telephone is outward- or toll-restricted, the user hears the touch tones, but the tones are not sent out over the line (and the user cannot, for example, accept collect calls by dialing 1).
Call Waiting	<p>A call to a sender with Call Waiting turned on goes to Individual and/or Group Coverage first. If all coverage points are busy, the sender receives the call-waiting tone.</p> <p>Changing the status of Coverage On/Off to on after hearing the call-waiting tone does not force the waiting call to coverage receivers, but sends subsequent calls to coverage.</p>
Camp-On	All individual and/or Group Coverage points must be busy before a call can be camped on to a coverage sender's extension. Coverage calls answered by a receiver can be camped-on to another user.
Centralized Voice Messaging	For Release 6.1 and later systems (Hybrid/PBX mode only), calls received by a MERLIN LEGEND System without a VMS can be sent by coverage to a centralized VMS located on another MERLIN LEGEND System.
Conference	You can originate a conference call from a Cover button only when you press the Transfer button, dial the number for another person, and then press the Conf button to complete the transfer. In this case, however, instead of the call being transferred, a conference call with three participants (including the originator) is established.
CTI Link	<p>When an extension is programmed as a CTI link, it is removed from membership in coverage groups.</p> <p>When a call is transferred from a programmed Cover button on an unmonitored DLC, screen pop is not initiated at the destination extension, even if it is using a CTI application.</p>

Digital Data Calls	<p>Individual Coverage is not recommended for 2B data calls. Because a coverage receiver can have only one Cover button for each coverage sender, only a 1B data call arrives at the receiver. The second call of a 2B call continues to ring at the coverage sender.</p> <p>Coverage delays do not apply to data calls. Calls ring immediately.</p> <p>Coverage is not recommended for video extensions. However, an MLX passive-bus telephone can be covered during 2B video calls (when both B-channels are busy), but it must have a programmed Do Not Disturb button. The user at the telephone activates Do Not Disturb during 2B calls.</p> <p>A passive-bus MLX telephone can be a coverage receiver, but this gives the user little control when B-channels must be available for 2B data.</p>
Direct-Line Console	<p>A DLC can be both an Individual or Group Coverage receiver and a member of a coverage group. No more than eight Primary Cover, Secondary Cover, or Group Cover buttons can be assigned on a DLC. A DLC can also be a sender.</p> <p>When a DLC is used in a system with a CTI link and is not itself using a CTI link application (that is, the DLC is unmonitored), calls transferred from a Cover button on the DLC do not initiate screen pop, even at screen pop-capable destinations.</p>
Direct Station Selector	<p>When a system operator transfers an Individual or Group Coverage call and the call returns, the red LED next to the DSS button for the sender does not flash as it does for a transfer return for calls received on other types of line buttons.</p>
Direct Voice Mail	<p>Direct Voice Mail overrides coverage-inhibiting features such as Coverage Off, Coverage VMS Off, and Coverage Inside Off.</p>
Display	<p>When an Individual or Group Coverage call is answered by a receiver with a display telephone, <i>Cover</i> or <i>Cov</i> is shown for the call type, followed by the sender's name, if programmed, or the extension number. The display also shows the reason why the call went to coverage: <i>No Ans</i>, <i>Busy</i>, or <i>DND</i>. On an MLX telephone, other reasons why calls are sent to coverage are also shown: <i>Invalid/unknown DID number</i> or <i>Invalid/unknown Remote Access number</i>. The receiver sees the caller information by pressing the <i>More</i> button.</p>

Do Not Disturb

When a sender turns on Do Not Disturb, Individual Coverage or Group Coverage receivers for that sender can call the sender. All other calls to the sender go to coverage.

When a receiver turns on Do Not Disturb, he or she does not receive coverage calls. A sender whose calls are set to be covered by the receiver, however, can call that receiver, despite Do Not Disturb.

If both a sender and all receivers have Do Not Disturb on, the sender's calls do not go to coverage and the caller hears a busy signal. On a personal line, the caller hears ringback and the green LED flashes, but the telephone does not ring.

In Release 2.1 and later systems, calls received on personal lines with Do Not Disturb on go immediately to coverage, instead of waiting for the Coverage Delay Interval.

Forward and Follow Me

In Release 3.0 and prior systems (or if the Forwarding Delay is programmed to zero rings), when a coverage sender forwards, calls are forwarded and sent to coverage at the same time. Calls received on any type of Cover button are not forwarded.

If a coverage receiver has activated any type of Remote Call Forwarding, calls sent to that extension by Coverage are not forwarded to the remote location.

In Release 4.0 and later systems, if both coverage and forwarding are on and the Forwarding Delay is greater than 0, one of the following occurs:

- A call that is sent to Group Coverage before the Forwarding attempt is not forwarded.
- A call that is remote call-forwarded before any coverage is not covered.
- A call that is remote call-forwarded while Primary and/or Secondary Coverage extensions are alerting is removed from those coverage points and is not sent to Group Coverage.
- If a call is sent to Group Coverage after forwarding, the call is removed from the called extension, the forwarded-to extension, and any Primary and Secondary Coverage buttons.
- If a user tries to forward a call before the coverage interval is reached, the call is not forwarded.

Group Calling

A calling group can be a receiver for up to 30 coverage groups. A calling group cannot be a receiver for Individual Coverage. A coverage group can have only one calling group as a receiver, but members of the coverage group can also have Individual Coverage receivers.

As soon as a Group Coverage call is sent from the calling group queue to a calling group member, ringing and LED flashing are removed from the sender's telephone, except for outside calls received on personal lines.

A calling group cannot be a sender, but an individual calling group member can be a sender for Individual Coverage and/or a member of a coverage group. When a call to the calling group extension number is sent from the queue to the calling group member, it goes only to the member's Individual Coverage receivers and not to the member's Group Coverage receivers. Calls to the member's individual extension go to both Individual and Group Coverage receivers.

When a calling group member with an MLX or ETR telephone receives an outside call for the calling group, the label of the calling group or `GrpCl` appears on the display, along with the label for the line on which the call came in. If ANI, station identification (SID, Release 2.0 and later systems), or another PRI-based caller identification service (Release 4.2 and later systems) is available, the number of the calling party is shown on the display on MLX or ETR telephones after the More button is pressed. MLS telephone users can view the calling party number by pre- or post-selecting the line button the call is on. Analog multiline telephone users see only the line information.

Coverage VMS Off can be activated if the user does not want outside calls to be sent to the voice messaging system.

Calls from the system to a VMI port are not sent to Primary, Secondary, or Group coverage.

In Release 6.1 and later systems, a calling group with a non-local member can be used to provide group coverage across the private network to a voice messaging system, calling group, QCC queue, DLC, or any individual extension on a remote MERLIN LEGEND, DEFINITY ECS, or DEFINITY Prologic system; or to the PSTN via UDP routing. Refer to the *Network Reference for details*.

In Release 6.0 and later systems, coverage calls directed to a calling group are not subject to queue control.

Hold Coverage calls answered by any type of receiver can be put on hold. The hold timer or operator-hold timer applies to a coverage call on hold.

In Release 2.1 and later systems, a call that has been put on hold on a Cover button can be picked up by a user who has a personal line for the call. When the call is picked up, the green LED next to the personal line lights steadily; however, the call is still on hold at the coverage receiver's telephone. The user who picked up the held call, therefore, cannot transfer the call. In order to transfer a call on hold at a Cover button, use Pickup instead of picking up on a personal line button.

HotLine Coverage features are not recommended for HotLine extensions (Release 5.0 and later systems).

Multi-Function Module An MFM can be a sender or a receiver for Individual or Group Coverage. This allows an MLX telephone user to screen calls by using an answering machine connected to the MFM or to supplement ringing with an external alert connected to the MFM. A sender can use Coverage Off to prevent calls from being sent to an answering machine.

Calls can be redirected to the MFM by assigning a Primary Cover, Secondary Cover, or Group Cover button. Coverage and Forward and Follow Me should not be used simultaneously.

Night Service When the system manager enables the Coverage Control option, a transition into Night Service operation (either by pressing the Night Service button at an operator's console or through the Time Set feature) automatically deactivates all programmed Coverage VMS Off buttons (LED is off) at extensions in the Night Service group. This allows calls to go to voice messaging system coverage at night.

When the system is taken out of Night Service—either by a press of the Night Service button at an operator's console or through the Time Set option—the Coverage Control option automatically activates all programmed Coverage VMS Off buttons, turning the LED on at extensions in the Night Service group. Outside calls no longer go to the voice messaging system.

A user at the extension can override the Night Service with Coverage Control option by pressing the programmed Coverage VMS Off button at any time.

Park A returning parked call is not eligible for coverage. A call answered on a Primary Cover, Secondary Cover, or Group Cover button cannot be parked on that button. To park calls received on a Cover button at your extension, press the Transfer button, dial your own extension, and press the Transfer button again to complete parking the call.

Personal Lines

Assigning a sender as the principal user of a personal line specifies that the calls received on the personal line are sent to the principal user's individual and group receivers. A principal user with Remote Call Forwarding on can forward calls received on the personal line to an outside number. Calls received on personal line buttons programmed for No Ring or on senders' extensions other than the principal user's are not eligible for coverage.

If no principal user is assigned and the personal line is shared by other senders, calls received on the personal line are sent to all available Individual Coverage receivers for all senders sharing the line and to the Group Coverage receivers programmed for the sender with the lowest logical ID.

In Release 2.1 and later systems, a call answered on a personal line using a Cover button can be picked up by anyone with a button for that personal line. The picked-up call, however, cannot be transferred because it is still considered to be on hold at the other extension.

Prior to Release 2.1, once a person answers a call received on a personal line on a Cover button and puts the call on hold, the sender and any other user who shares the personal line cannot pick up the call by pressing the personal line button. For proper handling, the receiver should transfer the call to the sender.

In Release 2.1 and later systems, calls received on personal lines with Do Not Disturb on go immediately to coverage instead of waiting for the Coverage Delay Interval.

Pickup

A coverage sender or receiver can be a member of a Pickup group. This allows Pickup to be used to answer a ringing Individual or Group Coverage call. If a sender who is a member of a Pickup group uses Coverage Off to stop calls from going to Individual or Group Coverage receivers, his or her calls can be picked up by using the Individual Pickup feature. Calls cannot be picked up, however, by using the Group Pickup feature. When a coverage call is answered using Pickup, the call is removed from other extensions in the coverage arrangement.

Pools

Calls received on a sender's Pool button programmed for Immediate or Delay Ring are eligible for Individual or Group Coverage.

Recall/Timed Flash

Recall has no effect on a call answered on any Cover button.

In Release 2.0 and later systems, Recall can be used on a Group Coverage call answered by a member of a calling group. In Release 1.0 and 1.1 systems, Recall cannot be used on a call of this type because it is answered on an SA or ICOM button.

Reminder Service

Reminder calls are not eligible for Individual or Group Coverage.

Ringling Options

Calls received on line buttons programmed for No Ring are not sent to coverage.

Primary Cover, Secondary Cover, and Group Cover buttons can be programmed for Immediate Ring, Delay Ring, or No Ring. If an Individual or Group Coverage receiver is on a call when a coverage call is received, the receiver hears an abbreviated ring (if abbreviated ringing is enabled).

Calls received on a Primary Cover, Secondary Cover, or Group Cover button ring with the receiver's (not the sender's) personalized ringing pattern.

In Release 4.1 and later systems, the ringing at a programmed Primary or Secondary Cover button, set for Delay Ring, is controlled by the Primary or Secondary Ring Delays set for the sender's extension. The systemwide Secondary Ring Delay Interval (fixed at two rings) also augments ringing on Secondary Cover buttons set for Delay Ring. For more information, see [Figure 6 on page 186](#) and [Figure 8 on page 188](#).

In addition to its primary function, the Delay Ring Interval in Release 4.0 and prior systems provides a delay before calls go to Group Coverage, in addition to the Coverage Delay Interval, when the sender also has Individual Coverage and a receiver is available.

Service Observing

In Release 6.1 and later systems, calls that arrive on Primary or Secondary Coverage buttons can be observed.

Calls that arrive on Group Coverage buttons can be observed.

Calls that go to Group Calling Coverage and are answered by a calling group agent can be observed.

Integrated or Generic VMI ports cannot be members of Service Observing groups; a call sent to one of these ports cannot be observed.

SMDR

The extension number answering an Individual or Group Coverage call is shown on the SMDR report.

In Release 4.2 and later systems, when an Auto Login or Auto Logout calling group is programmed as a Group Coverage receiver and the SMDR Talk Time option is enabled, calls are reported following the same rules that apply to other incoming calling group calls. This is true even if a call is transferred from an operator to a Group Coverage sender before being directed to the calling group.

System Access/ Intercom Buttons

A covered call remains on the sender's SA or ICOM button until it is answered at the receiver's telephone. Once answered by a receiver, the call is removed from the sender's SA (including Shared SA) or ICOM button. When a calling group is programmed as a Group Coverage receiver, however, the call is removed from the sender's telephone as soon as it is sent from the calling group queue to an available member.

A call received on a Shared SA button is not eligible for any coverage.

If a receiver programs a Primary Cover, Secondary Cover, or Group Cover button for a sender and also has an SSA button associated with the sender, the green LEDs next to both the Cover button and the Shared SA button flash. The red LED stays on at the Shared SA button, but does not go on at the Cover button.

Transfer

A call answered on any Cover button can be transferred.

Calls transferred to a sender are eligible for Individual and/or Group Coverage. However, the sender hears a call-waiting tone if he or she is using Coverage Off to prevent calls from going to coverage and does not have an available SA or ICOM button to receive a transferred call.

With one-touch Transfer, a call answered on a Cover button can be transferred by using a DSS button, but not by using an Auto Dial button.

Transfer returns are not eligible for coverage.

UDP Features

In Release 6.0 and later systems (Hybrid/PBX mode only), non-local UDP calls are treated as outside calls by the system and by Selective Coverage features: Coverage Off, Coverage Inside, and Coverage VMS Off.

In Release 6.0, calls cannot be covered by non-local extensions or non-local calling groups.

In Release 6.1 and later (Hybrid/PBX mode only), although calls cannot be sent directly to non-local extensions or calling groups for coverage, they can be sent to a local calling group that has a non-local calling group extension as its only member.

Voice Announce

If the sender's speakerphone is available, a voice-announced call is answered as soon as it is made. If the sender's speakerphone is in use, the call is converted to a ringing call and sent to coverage.

CTI (Computer Telephony Integration) Link

At A Glance

Users Affected	MLX and analog multiline telephone users at companies with local area networks (LANs) running Novell NetWare, or Microsoft Windows NT [®] 4.0 Server or Workstation
Reports Affected	System Information (<code>SysSet-up</code>) and Extension Information
Mode	Hybrid/PBX
Telephones	MLX, ETR, MLS, and analog multiline telephones
MLX Display Label	CTILINK
System Programming	First, follow the instructions in the <i>System Manager's Guide</i> to busy-out the module for the CTI link. If there is only one MLX module on the system, you must use System Programming and Maintenance (SPM) software to program the link. Then, to assign the CTI link extension: <ul style="list-style-type: none"> ■ <code>AuxEquip</code>→<code>CTI Link</code>→<code>Dial extension number</code>

Description

Release 5.0 and later systems support the use of an MLX port as a Computer Telephony Integration (CTI) link on Hybrid/PBX mode systems. The CTI link feature allows CTI applications to interact with the MERLIN LEGEND Communications System over a local area network (LAN). The CTI link is the system's hardware and software interface to the Lucent Technologies PassageWay Telephony Services product, which supports the Windows[®] 95, Windows NT, Windows 3.1, Windows 3.11 for Workgroups, Apple[®] Macintosh[®] OS and UNIX[®] systems platforms on the client side. CTI link circuitry connects to an MLX port on the system and to a LAN server using Novell NetWare (releases 3.12, 4.1, and 4.11) or Windows NT 4.0 Server or Workstation software (Server is recommended).

⇒ NOTES:

- The Apple Macintosh and some of the UNIX client libraries for Telephony Service do not support MERLIN LEGEND Communications System private data. They only support standard Telephony Services Application Programming Interface (TSAPI) call services and events. For details regarding this issue, see the *PassageWay Telephony Services Network Manager's Guide*.

- Passageway Direct Connect is supported only on MLX telephones.
- In Release 6.0 and later systems (Hybrid/PBX mode only), operation of LAN clients using PassageWay Telephony Services applications connected via a CTI link depends on the application implemented and the type of private trunks that connect the networked communications systems. These constraints apply only to calls that are carried by these private network trunks—generally, calls from non-local dial plan extensions. For additional information about this operation, see [“Private Network Operation \(Release 6.0 and Later Systems Only\)” on page 217](#). For more information about private networks, see [“Uniform Dial Plan Features” on page 741](#).

Client software using the CTI link can perform the following actions on a user's computer:

- Screen pop (Calling Party Number, not Calling Party Name)
- Power dial
- Basic call control

CTI client applications can control functions at extensions with MLX, ETR, MLS, or analog multiline telephones.

Following are brief descriptions of the platform requirements for a CTI link and the features listed above. For more detailed information about these features, see the *PassageWay Telephony Services Network Manager's Guide*.

Platform Requirements

A CTI link requires the following equipment:

- MERLIN LEGEND Communications System Release 5.0 or later, in Hybrid/PBX mode. If you are running Windows NT 4.0 Server or Workstation software, the system must be Release 6.1 or later.
- An MLX line/trunk or extension module, with a free extension jack, installed in the communications system control unit. A free extension jack cannot be the first or fifth port on a 008 MLX, 408 GS/LS-MLX, or 408 GS/LS-ID-MIX module; or the first, fifth, ninth, or thirteenth port on a 016 MLX module (Release 7.0 and later systems). A free extension jack cannot be a port programmed as an operator or programming console. The MLX module must have a certain firmware vintage or application vintage. See the *System Planning Guide* for details.



NOTE:

If the MLX module for the CTI link is the only MLX module in the system, SPM software, version 5.15 or later, is also required in order to program the CTI link.

- Additional equipment and software is needed, depending on the software the LAN is using:
 - If using Novell NetWare version 3.12, 4.11, or 4.1:
 - An Intel® i386, i486, or Pentium® class computer with at least 16 MB of RAM. More memory may be needed if additional applications will be running on the server machine. See the *PassageWay Telephony Services Network Manager's Guide* for more information.
 - 5 MB of available disk space in the system volume.
 - MERLIN LEGEND Passageway Driver®, version 1.1 or later installed.
 - Telephony Services for NetWare software, Release 2.2.1 or later.
 - An Eicon SCOM ISDN BRI card for the CTI link.
 - A free 8-or 16-bit ISA slot for the ISDN BRI card.
 - Interrupt 2 or Interrupt 3 available.



NOTE:

For a NetWare version 3.12 installation, additional files must be obtained from Novell's web site. For details, see the *PassageWay Telephony Services Network Manager's Guide*.

- If using Windows NT 4.0 Server:
 - A 486-class or Pentium computer with a CD-ROM and at least 32 MB of RAM and 11 MB of disk space. More memory may be needed if additional applications will be running on the Telephony Server machine.
 - MERLIN LEGEND NT PBX Driver version 1.0 or later installed.
 - CentreVu® Computer Telephony for Windows NT software, Release 3.10 or later.
 - An Eicon DIVA Version 2.01 ISDN BRI card for the CTI link.
 - A free 16-bit ISA slot for the ISDN BRI card.

For more information about these requirements and about installing a CTI link, see the *PassageWay Telephony Services Network Manager's Guide*.

Screen Pop

Screen pop occurs when a CTI application takes inside or outside caller information, queries a database, and displays caller information on a user's PC screen. Screen pop requires that an identifying number or code be available to identify the outside calling party. This number may be a telephone number provided by Caller ID, ANI, or another network service.

Screen pop can also occur when the caller enters an identifying code after connecting to a voice-response unit in the system. The voice-response unit (MERLIN LEGEND Enhanced Service Center for example) may prompt the caller to dial a social security number, account number, customer number, or other database index code. These *collected digits* are used to initiate screen pop of database information. For more information, see the next section, "[Collected Digits](#)" on page 213.

Screen pop can occur on incoming voice calls from the following sources:

- Calling group distribution
- ISDN PRI routing by dial plan
- An extension on the MERLIN LEGEND Communications System
- Remote access



NOTE:

In this case, the only information that the application can collect about the caller is the remote telephone number.

- A transfer of a call that has been answered by a voice-response unit



NOTE:

In Release 6.0 and later systems, transferred calls from non-local extensions can only initiate the correct screen pop when the transfer is without consultation and the private network systems are connected by PRI tandem trunks. Otherwise, only the transfer originator information is available for screen pop. If the private trunks are tandem tie trunks, they do not convey screen pop information over the network. Collected digit information is not sent to a non-local extension, even if tandem PRI trunks carry the call.

- A transfer or conference of a call that has been answered at a local DLC or QCC

 **NOTES:**

- Some CTI applications can initiate screen pop from the called number on a BRI or PRI line. To find out whether this feature is available, check your application's documentation.
- To obtain calling party information on a loop-start line, your organization must subscribe to Caller ID services, if available, from the local telephone company. A line/trunk module with Caller ID capability is also required, and the system must be programmed for Caller ID (see [“Caller ID” on page 125](#)). Calling Party Name, however, is not displayed. On BRI and PRI lines, calling party identification services may be available from a network service provider. For more information, see [“Basic Rate Interface \(BRI\)” on page 99](#) and [“Primary Rate Interface \(PRI\) and T1” on page 509](#).

Some CTI applications allow screen pop either on demand or when a call is answered. These applications may initiate screen pop for all calls, even those answered at the telephone on a line button other than an SA button. If a call does not come in on an SA button, however, screen pop does not occur when the call is ringing, only after it is answered. In addition, when a call does not arrive on an SA button, the CTI application cannot handle a transfer, conference, hold, or other activity for that call. You must perform these actions manually, using the telephone.

When an outside call is answered initially by a voice-response unit that prompts for caller information (such as a customer number), that information is passed on to the person receiving the call, assuming that the receiver has screen pop capability and that the application uses transfer with consultation. As a result, screen pop occurs at the destination.

 **NOTE:**

In a transfer or conference with consultation, available on inside calls only, the user initiating the transfer or conference calls the destination extension and speaks to the person at that extension before completing the transfer.

The Transfer and Conference features, when activated manually (using the telephone) at a non-operator extension, do *not* provide the original caller's information (telephone or extension number) to the recipient who has screen pop capability. For example, if you manually press the Transfer button, instead of using the application, then dial an extension and have the application complete the transfer, the original caller information is not sent to the receiver.

Collected Digits

As noted in the previous section, another method of using the screen pop capability is to display a screen based on information entered directly by the caller rather than based on the caller's telephone number. This requires a voice messaging system (VMS) or an integrated voice response (IVR) application (such as the MERLIN LEGEND Enhanced Service Center Release 2) capable of collecting the caller's input.

When the VMS or IVR application answers a call, it plays a message instructing the caller to enter additional digits, such as a social security number, zip code, or customer account number. These additional digits are referred to as *collected digits* or *prompted digits*.

Based on the caller's input, the VMS or IVR application transfers the call to the MERLIN LEGEND Communications System switch, which then routes the call to the proper destination. When the call arrives at the monitored extension, the switch passes the digits to the CTI application, which, in turn, passes these digits to the customer's existing database. The database searches its records for information relating to the collected digits, and returns a screen displaying the data it found.

Refer to the documentation that came with the VMS or IVR application for instructions on installing and programming the collected digits feature.

If you plan to use an application that uses collected digits, you must program the following:

- In the application that collects the digits, the "transfer to subscribers only" option must be active, and the extensions must be allowed to transfer calls.
- In the voice messaging system, program regular voice mailboxes as normal cover-answer mailboxes.

Power Dial

Power Dial is an application feature where software on the computer initiates a voice call on a specified telephone to an inside or outside number. It is generally used by people who must make a large volume of calls to individuals whose telephone numbers are stored in a customer or client database. For example, Power Dial is often used by telemarketers and fundraisers.

Basic Call Control

A CTI application on your PC can control an extension's SA button operations. No other buttons (for example, personal lines) are monitored by applications or are allowed to perform the CTI services. Basic call control includes:

- Answering calls arriving on an SA button.
- Making calls from an SA button.
- Hanging up calls.
- Holding and retrieving a call on hold your extension.
- Inside transfer.
- Three-party conference, including those conferences where one or two parties are outside the system.



NOTES:

- In Release 6.0 and later systems, a conferee in the non-local dial plan is considered to be outside the system.
- In Release 6.0 and later systems, if you are on a PassageWay Telephony Services client extension with a call on an analog Centrex loop-start line, and you attempt to transfer that call to an extension with Centrex Transfer via Remote Call Forwarding activated, the call is immediately transferred without consultation. The originator is disconnected.

CTI applications vary in how they use the system's features. The list of basic call control activities includes the functions that a CTI application *may* control; a given application does not *necessarily* use these system features.

DLC operator extensions can use CTI applications, although QCCs cannot. If a DLC's SA button operations are controlled by a CTI application, caller information is passed on to a three-way conference or transfer destination, as long as the operator uses the application to perform the transfer or conference. (The DLC extension works as any other screen pop capable extension does.) If a DLC operator's SA calls are *not* controlled by a CTI application, then caller information for transferred or conferenced calls is also passed on to a screen pop capable extension, just as with a QCC. The only exception occurs when a call is transferred from a Cover button on a DLC. In this case, there is no screen pop at the destination extension.

**NOTE:**

In Release 6.0 and later systems, the display of incoming and outgoing calls from and to non-local extensions depends upon the PassageWay Telephony Services application, the private network trunks, and how the call is routed. For more information, see [“Private Network Operation \(Release 6.0 and Later Systems Only\)” on page 217.](#)

Programming a CTI Link

System Programming includes complete information about programming a CTI link. When you program a CTI link, ensure that no telephone, fax, videoconferencing system, or digital communications equipment is connected to the MLX port. A working or potential system programming or operator position extension cannot be programmed as a CTI link; therefore, a CTI link cannot be programmed on the first or fifth extension jack of an MLX module. A CTI link can be programmed on port 2, 3, 4, 6, 7, or 8 of the MLX module.

In order to program a new CTI link, or remove an existing one, you must first busy-out the slot where the MLX module for the CTI link is located or where you plan to install it. For this reason, if you program the CTI link using an MLX-20L telephone programming console, that console must *not* be connected to the same MLX module where you have installed, or plan to install, the CTI link. (See [“Programming” on page 557](#) for more information about programming options. For details about busy-ing-out a slot in the control unit, see the *System Manager’s Quick Reference*.)

**NOTE:**

If your system includes only one MLX extension module, you must use a PC and System Programming and Maintenance (SPM) software to program the CTI link.

**CAUTION:**

The Maintenance procedures that you use to busy-out and restore a module are normally reserved for Lucent Technologies technicians only.

When you add a CTI link, the system performs the following actions:

- Reverts button programming to the default for a non-operator MLX telephone.
- Informs you when there are programmed Cover buttons for the CTI link extension on other extensions in the system. These Primary and/or Secondary Cover buttons are not removed from the associated extensions. To identify these extensions and remove the Cover buttons, consult the Extension Information Report for the system, or refer to the relevant

system planning forms for extensions and groups (for example, Form 4d, MLX Telephone, and Form 7c, Group Coverage). Appendix D includes instructions for removing button programming.

- Deactivates forwarding to the extension.
- Removes the extension from membership in calling groups.
- Removes the extension from membership in coverage groups.
- Changes the Extension Directory label for the extension to CTILINK.
- Sets the Alarm feature to the default setting (on) for a CTI link.
- Restricts dial access to pools for the extension.
- Renders the 2B data programming nonfunctional if the jack is programmed for 2B data. The 2B data programming is not removed from the main or adjunct extension. If you want to use 2B data, reassign the feature to another port. See *System Programming* for information about removing or assigning 2B data.

Considerations and Constraints

The Transfer and Conference features, when activated manually (using the telephone) at a non-operator extension, do *not* provide the original caller's information to the recipient who has screen pop capability.

Some CTI applications may initiate screen pop for all calls, even those answered at the telephone on a line button other than an SA button. Screen pop, in this case, occurs only after a call is answered. In addition, if a call does not come in on an SA button, the CTI application cannot handle basic call control for that call. The user must perform these actions manually, using the telephone.

When a DLC is not using a CTI application, calls transferred from a DLC's programmed Cover button do not initiate screen pop, even when the destination is a screen pop-capable extension.

CTI link extensions cannot be programmed on tip/ring, enhanced tip/ring, or analog multiline telephone module ports. You must choose an extension that is on an MLX port module.

You cannot program the first or fifth port on an MLX module as the CTI link extension, because these ports are reserved for operator positions. On the 016 MLX module (Release 7.0 and later systems) there are potential operator positions on the ninth and thirteenth ports, as well as on the first and fifth ports.

If you program a CTI link for a jack that is already programmed for 2B data, the CTI programming overrides the 2B data programming, and a 2B data device that

you later connect to the jack will not function as such. For more information about 2B data, see [“Digital Data Calls” on page 223](#).

You cannot use a system programming port as the CTI link extension.

You cannot program a port as a CTI link if it has a telephone or other device connected to it. However, the port may have the CTI link hardware plugged in.

Because CTI link programming requires that you busy-out the control unit slot where the MLX module with the CTI link is being added or removed, either you must use SPM software to program the CTI link, or the link must be located on a different module from the one where the system programming MLX-20L console is connected. The busy-out programming procedure is available from the system's Maintenance menu. For details about busying-out a slot in the control unit, see the *System Manager's Guide*.

An extension programmed as a CTI link should not be used as a phantom extension (an extension that does not serve equipment plugged into the system but used for a special purpose—for example, coverage by a voice messaging system).

In Release 6.0 and later systems, if you are on a PassageWay Telephony Services client extension with a call on an analog Centrex loop-start line, and you attempt to transfer that call to an extension with Centrex Transfer via Remote Call Forwarding activated, the call is immediately transferred without consultation. The originator is disconnected.

Private Network Operation (Release 6.0 and Later Systems Only)

Operation for non-local extension calls in CTI-linked PassageWay Telephony Services applications depends upon the application implementation as well as the type of private networked trunk (PRI, analog tie, or T1 tie) that carries calls between the systems, according to the following rules:

- For an outgoing call, if the PassageWay Telephony Services application uses the length of a destination telephone number in order to differentiate PSTN calls from UDP calls, a PassageWay Telephony Services client displays a non-local extension call in the same way as it does inside calls.
- For an outgoing call, if the PassageWay Telephony Services application uses receipt of the *Network Reached event* to differentiate PSTN calls from inside calls, a PassageWay Telephony Services client displays a non-local extension call or other UDP-routed call in the same way it does an outside call made to the public switched telephone network.

- For an incoming call, if the PassageWay Telephony Services application uses the length of ANI information to differentiate PSTN calls from UDP calls, a PassageWay Telephony Services client displays a non-local UDP call as an inside call.
- For an incoming call, if the PassageWay Telephony Services application uses the presence of a trunk identifier in the *delivered event* to differentiate PSTN calls from UDP calls, a PassageWay Telephony Services client displays a non-local UDP call in the same way it does a PSTN call.
- For an incoming PSTN call that enters the private network on a PRI trunk with an ANI of length shorter than seven digits and crosses PRI tandem trunks only, the recipient PassageWay Telephony Services client display depends on the PassageWay Telephony Services application implementation.

If the PassageWay Telephony Services application does not strip leading zeros, the PassageWay Telephony Services client displays the ANI information with any leading zeros needed to make the information seven digits long.

If the PassageWay Telephony Services application strips leading zeros, the recipient PassageWay Telephony Services client displays the ANI information in its original length. The call displays as an inside or outside call, depending on whether ANI information or a trunk identifier in the *delivered event* is used to differentiate the call.

If the non-local dial plan recipient of a transfer or conference call is a PassageWay Telephony Services client, the recipient's display shows caller information about the conference or transfer originator, not about any other caller. Users at CTI-linked PassageWay Telephony Services extensions must use the telephones at their extensions to make transfers to non-local dial plan extensions or to add conferees to a conference. They cannot use their PassageWay applications. A PassageWay Telephony Services client display does not provide an indication when a conferee is dropped.

A call may come in from the PSTN to an auto attendant, such as MERLIN LEGEND Mail, that collects digits from the caller (a customer number, for example). If the application then sends the call to a non-local PassageWay Telephony Services client, the collected digits do not trigger screen pop at the recipient display, regardless of the type of trunks over which the call is routed.

If a call that has collected digits associated with it is answered and then transferred, the collected digits do not transfer to a non-local PassageWay Telephony Services client, regardless of the facility.

Mode Differences

Key and Behind Switch Modes

A CTI link cannot be used with communications systems operating in Key mode or Behind Switch mode.

Telephone Differences

Queued Call Consoles

Because an operator position cannot use a CTI application, a call to an operator QCC does not initiate screen pop. The call can initiate screen pop at a screen pop capable extension when an operator transfers a call immediately, or during consultation, when the operator talks to the system user before transferring a call. The screen pop shows calling party identification information, if available, at the extension.

Direct-Line Consoles

A DLC either can function as an operator and unmonitored extension or can use a CTI application and function as a *monitored extension*. An unmonitored extension uses the telephone to transfer or conference a call.

A monitored DLC position functions like any other MLX or analog multiline extension that is using a CTI application. An outside call to the position initiates screen pop at the DLC extension. When a monitored DLC manually transfers or conferences a call, only the DLC extension number is passed to the destination extension or extensions.

In most respects, unmonitored DLCs operate like QCCs for screen pop. Calls to unmonitored DLCs do not initiate screen pop at the operator extension; when transferred or conferenced, they do initiate screen pop at a destination extension using a CTI application. Calls transferred from a DLC's programmed Cover button, however, do not initiate screen pop, even when the destination extension supports screen pop.

Single-Line Telephones

Single-line telephone extensions cannot take advantage of CTI applications.

Feature Interactions

Alarm	When a CTI link is reset (called a <i>broadcast reset</i>), any programmed Alarm buttons on operator consoles or connected alarm devices go on.
Conference	<p>CTI link applications can control conferences of up to three parties, including those where one or two parties are outside the system.</p> <p>When performed by a QCC operator or unmonitored DLC operator, the Conference feature generates screen pop at screen pop capable destinations.</p> <p>When a conference is initiated manually at the telephone of an extension using a CTI application, screen pop is initiated for inside parties only (not initiated for outside parties) at screen pop capable destinations, even when the application is used to complete the conference.</p> <p>If the non-local dial plan recipient of a conference call is a PassageWay Telephony Services client, the recipient's display shows caller information about the conference originator, not about any other caller. Users at CTI-linked PassageWay Telephony Services extensions must use the telephones at their extensions to add conferees to a conference. They cannot use their PassageWay applications. A PassageWay Telephony Services client display does not provide an indication when a conferee is dropped.</p>
Coverage	<p>When an extension is programmed as a CTI link, it is removed from membership in coverage groups.</p> <p>When a call is transferred from a programmed Cover button on an unmonitored DLC, screen pop is not initiated at the destination extension, even if it is using a CTI application.</p>
Digital Data Calls	If you program a CTI link for an extension that is already programmed for 2B data, the 2B data programming is overwritten. The 2B data programming should be removed from the extension.
Direct-Line Console	A DLC's SA calls can be controlled by a CTI application. When they are, the DLC position functions like any other MLX or analog multiline extension, that is using a CTI application. An outside call to the position initiates screen pop at the DLC extension.

Features

CTI (Computer Telephony Integration) Link

221

Direct-Line Console
(continued)

Calls to DLCs not using a CTI application do not initiate screen pop at the operator extension; when transferred or conferenced—even if they arrive on the DLCs personal line button—they do initiate screen pop at a destination extension using a CTI application. Calls transferred from a DLC's programmed Cover button, however, do not initiate screen pop, even at destination extensions that support screen pop.

Directories

The extension that is programmed as a CTI link can have its label changed through system programming.

Forward and Follow Me

When an extension is programmed as a CTI link, forwarding to the extension is deactivated.

In Release 6.0 and later systems, if you are on a PassageWay Telephony Services client extension with a call on an analog Centrex loop-start line, and you attempt to transfer that call to an extension with Centrex Transfer via Remote Call Forwarding activated, the call is immediately transferred without consultation. The originator is disconnected

Group Calling

When an extension is programmed as a CTI link, the extension is removed from membership in calling groups.

To ensure that calling group overflow calls initiate screen pop at destination extensions, set all personal lines at calling group overflow receivers to No Ring. For example, if an unmonitored DLC overflow receiver has only a personal line—set to Immediate Ring—available for a calling group overflow call, the call arrives on the personal line button. Therefore, caller information is not sent to the destination extension when the DLC operator transfers the call.

Hold

A CTI link application can put an SA button call on hold.

Pools

When an extension is programmed as a CTI link, dial access to pools is removed from the extension.

Personal Lines

If an unmonitored DLC transfers a call that arrived on a personal line, the screen pop caller information is sent to the destination extension, provided that the destination extension is using a CTI application.

Service Observing

In Release 6.1 and later systems, Service Observing cannot be programmed on a CTI link. Extensions serving as CTI links cannot be programmed as Service Observers nor as members of Service Observing groups. If an extension is programmed as a CTI link, it is removed as a Service Observer or a Service Observing group member.

CTI user (client) extensions can be Service Observers as well as members of Service Observing groups.

The Service Observer cannot use a CTI application (such as Passageway Telephony Services or Passageway Direct Connect) while actively observing an extension.

Features

CTI (Computer Telephony Integration) Link

222

System Access/ Intercom Buttons

CTI allows software on a worktop application to control the following:

- Placing a call on hold
- Retrieving a call from hold
- Inside transfer and three-party conference
- Answering
- Hanging up on the SA buttons of an extension using the application

System Renumbering

When the dial plan changes, the applications must use the new extension number in any request. The PassageWay Telephony Services security database should be updated with the dial plan changes so that permissions are set for the new extension numbers and cleared for the old extension numbers. Some settings in the CTI software applications may need to be updated as well.

Transfer

CTI link applications can control inside transfers, not transfers to outside numbers. When a CTI application is used to initiate a transfer, caller information is passed to a screen pop capable destination.

When a transfer is initiated manually, using the telephone at an extension where a CTI application is installed, screen pop is not initiated at a screen pop capable destination, even if the CTI application is used to complete the transfer.

A transfer by a QCC or unmonitored DLC operator generates screen pop of inside or outside caller information at screen pop capable destinations.

UDP Features

In Release 6.0 and later systems (Hybrid/PBX mode only), operation for non-local dial plan extension calls, both incoming and outgoing, in PassageWay Telephony Services applications depends upon the application implementation, the type of private networked trunk (PRI or tie) that carries calls, and how the PassageWay Telephony Services Application differentiates PSTN calls from inside and UPD calls. See [“Private Network Operation \(Release 6.0 and Later Systems Only\)” on page 217](#) for details.

Digital Data Calls

At a Glance

Users Affected	Users with digital data communications devices or videoconferencing systems only
Reports Affected	Extension Directory, Extension Information
Modes	Key, Hybrid/PBX
Factory Settings 2B Data	Disabled
System Programming	To assign the 2B Data feature to an MLX adjunct extension: <ul style="list-style-type: none"> ■ More→Data→2xB Data→Enter adjunct extension number

Description

The MERLIN LEGEND Communications System supports many options for high-speed digital data transfer over Integrated Services Digital Network (ISDN) and T1 Switched 56 facilities, or between two extensions on the MERLIN LEGEND Communications System. To transfer data, you must have an ISDN terminal adapter or other system-compatible digital communications device connected to an MLX port.



NOTE:

A communications device may be included in a hardware and software application, for example, a video system. For more information about digital data and 2B data, see the *Data/Video Reference*.

The supported connections for making digital data calls are:

- ISDN PRI lines
- ISDN BRI lines
- T1 Switched 56 lines

An extension that includes a digital data communications equipment (DCE) device is called a *digital data workstation*. It may or may not include a telephone, but it is always connected to at least one MLX extension jack. If the DCE includes an ISDN-BRI interface, it can use the system's 2B Data feature to combine the B-channels of a single MLX jack. Many group and desktop videoconferencing systems support 2B data, as do some DCE devices used for data only (not video)

communications. 2B data is described in more detail in [“2B Data”](#) later in this topic.

If a videoconferencing system requires two B-channels but does not have an ISDN-BRI interface (some older group video systems have V.35 interfaces, for example), it may need to use the adjunct extension numbers of two different MLX extension jacks.

Primary Rate Interface

The ISDN Primary Rate Interface (PRI) is a standard access arrangement that can be used to connect the system to a network providing voice and digital data services.

PRI is a standard access arrangement that uses a DS1 facility (also called a pipe) to support twenty-three 64-kbps data connections (known as *B-channels*) and one 64-kbps connection (known as a *D-channel*). The D-channel is used to convey signaling information. Some PRI service allows only voice calls and does not support data. For more information, see [“Primary Rate Interface \(PRI\) and T1” on page 509](#).

T1 Switched 56 Lines

A T1 facility can be connected to the MERLIN LEGEND Communications System to supply a number of data and voice services. Release 4.0 and later systems can support one Switched 56 (56 kbps) data connection on each Digital Signal Level 0 (DS0) channel of the T1 facility. There are 24 DS0 channels on each T1 facility. For more information, see [“Primary Rate Interface \(PRI\) and T1” on page 509](#).

Basic Rate Interface

Basic Rate Interface (BRI) is a standard ISDN access arrangement that can be used to connect the system to a network providing voice and digital data services. The full designation for BRI service is ISDN NI-1 BRI. BRI is supported in Release 4.0 and later systems only. BRI supports two 64-kbps data connections (known as *B-channels* or *lines*) for up to 128 kbps data throughput. For more information, see the section [“Basic Rate Interface \(BRI\)” on page 99](#).

2B Data

The combination of two data-bearing channels (B-channels) allows ISDN-BRI devices (such as desktop and group video systems with ISDN-BRI interfaces) to connect to a single MLX port and make full 128-kbps connections using ISDN NI-1 BRI or ISDN PRI B-channels, or make 112-kbps connections when T1 Switched 56 facilities are used.



NOTE:

For more information about 2B data, see the *Data/Video Reference*.

Devices used for 2B data must be connected to MLX jacks that are programmed as 2B data-capable. Devices that do not support 2B data should not be connected to ports programmed for 2B data.

The MLX extension numbers used to add 2B data capability must correspond to the adjunct extension number for the MLX telephone. By default, in a two-digit numbering plan, these adjunct extensions are numbered with the digit "7" preceding the two-digit extension number. If the MLX extension is 20, its corresponding adjunct extension is 720. In a 3-digit or Set Up Space numbering plan, the adjunct extension number is, by default, the main extension number plus 200. (For details, see ["System Renumbering" on page 685.](#))

Once an MLX jack is correctly programmed, a 2B data-capable device properly connected to the jack should operate at the same data rate (up to 128 kbps) as an NI-1 BRI line connected directly to a central office.

2B data calls are really two calls, one for each B-channel. (Similarly, ISDN terminal adapters that connect to V.35 video systems must make and receive two calls in order to provide double the speed of a single digital call.)



NOTES:

- Users can use any combination of PRI, NI-1 BRI, and T1 lines to obtain a 2B data connection. However, data transfer speeds are slower on T1 Switched 56 lines (56 kbps on each line). Because of potential speed and other conflicts, it is best to use the same type of facility for both calls that make up a 2B data call.

- In Release 6.0 and later systems (Hybrid/PBX mode only), MERLIN LEGEND Communications Systems can be connected to one another or to DEFINITY ECS or DEFINITY ProLogix Solutions systems in a private network. If the tandem trunks connecting the systems are PRI and two B-channels are available, 2B data digital calls between the systems can take place at 128 kbps. If the tandem trunks connecting the systems are T1-emulated tie data trunks and two channels are available, 2B data digital calls between the systems can take place at 112 kbps.

Considerations and Constraints

Features that redirect calls (for example, Coverage, Forwarding, Data Hunt Groups, and Night Service) can present problems for 2B data calls. For example, a video system should not be a coverage sender because another video system receiving calls for it can be assigned only one Cover button for the sending

extension. Therefore, only one call of a 2B data call is sent to the receiver, and the second call continues to ring at the sending system. (See "[Feature Interactions](#)," later in this topic, for more information.)

In Release 6.0 and later systems (Hybrid/PBX mode only), when MERLIN LEGEND and/or DEFINITY ECS or DEFINITY ProLogix Solutions systems are connected in private networks, 2B digital data calls across these networks can take place over PRI tandem trunks or T1-emulated tie data tandem trunks, at speeds up to 128 kbps for PRI or 112 kbps for T1-emulated tie data. If any analog tandem tie trunks are in the communications path, only analog data calls can take place.

MLX modules of firmware vintage 29 are not compatible with 2B data. You must program the feature on a jack whose module is of earlier or later vintage.

Applications

The high-speed data capabilities of the MERLIN LEGEND Communications System can be used for a number of applications, including videoconferencing, Internet access, and data transfer.

Depending upon its capabilities, a videoconferencing system may offer application-sharing, video collaboration, and data-sharing on either one or two data channels at a time (most video systems require two channels for 2B data). If one channel is used, the maximum data speed is 64 kbps (PRI) or 56 kbps (T1 Switched 56); if two channels are used, the maximum data speed is 128 kbps or 112 kbps.

Telephone Differences

Queued Call Consoles

QCCs cannot be programmed for 2B data. If a DLC is programmed for 2B data, the DLC cannot be changed to a QCC unless 2B data programming is first removed from the DLC.

Feature Interactions

- | | |
|----------------------------------|---|
| Account Code Entry | Account Code Entry can be entered for calls made by digital data workstations and by video systems that support the use of # for feature codes. The account code must be entered before the telephone number. |
| Authorization Code | Data calls can use authorization codes. If Account Code Entry is also used, the authorization code must be entered after the account code.

Authorization codes can be used by video systems that support the use of # for feature codes. |
| Auto Dial | A terminal adapter can make a call using an Auto Dial button by dialing the virtual number of the button (for example #01). A video system that supports entering # for feature codes can use Auto Dial in the same fashion. |
| Automatic Route Selection | Data calls can be made using ARS. To make calls using ARS, digital devices simply dial the ARS dial-out code (usually 9) followed by the telephone number. Data calls <i>must</i> be routed through ARS pools that access only PRI, NI-1 BRI, and/or T1 Switched 56 data lines. To make a 2B data call, you must make two calls on different lines. |
| Barge-In | You cannot barge into data calls. |
| Call Waiting | Call Waiting does not work on data calls. A call appears to wait but does not return to the extension when it becomes available. This feature should be disabled at video systems and data extensions. |
| Callback | Videoconferencing systems that can dial feature codes using # can use Selective Callback. When a pooled line becomes available or the busy video system is idle, the queued call is made, one B-channel at a time. When the second B-channel becomes available, it can be used for the connection as well, providing the video system supports this capability. |

Callback <i>(continued)</i>	<p>Although video systems can use either off-hook or on-hook Callback, you should only use off-hook Callback for 2B data connections. If you use on-hook Callback, the returning callback call is connected using only one B-channel.</p> <p>Automatic Callback should be disabled for digital data and videoconferencing extensions.</p>
Camp-On	<p>You cannot camp onto data or video calls.</p>
Conference	<p>Conference does not function with data calls.</p> <p>2B data video calls require both B-channels at a video workstation.</p>
Coverage	<p>Individual Coverage is not recommended for 2B data calls. Because a coverage receiver can have only one Cover button for each coverage sender, only a 1B data call arrives at the receiver. The second call of a 2B call continues to ring at the coverage sender.</p> <p>Coverage delays do not apply to data calls. Calls ring immediately.</p> <p>Coverage is not recommended for video extensions.</p>
CTI Link	<p>If you program a CTI link for an extension that is already programmed for 2B data, the 2B data programming is no longer functional. The 2B data programming should be removed from the extension.</p>
Directories	<p>Digital communications devices and videoconferencing systems cannot make use of Extension, Personal, or System Directories.</p>
Do Not Disturb	<p>Digital communications devices can activate Do Not Disturb by dialing the virtual button number (for example #01) of the Do Not Disturb button. Do Not Disturb can be activated by video systems that have the ability to dial strings and feature codes that begin with #.</p>
Forward and Follow Me	<p>Digital communications devices can forward calls by dialing the associated feature code.</p> <p>Forward can be activated by video systems that have the ability to dial strings and feature codes that begin with #. 2B data calls are forwarded as two 1B data calls.</p> <p>Remote Call Forwarding features are not available at video system extensions.</p>
Group Calling	<p>Lines intended for data calls should not be mixed in the same calling group with lines intended for voice calls.</p> <p>Video systems can connect only with 1B data connections (provided that the video application supports 1B data) when receiving a call through a calling group (called a <i>Data Hunt Group</i> when used for data calls), because a calling group dispenses only one call to each calling group member.</p>
Hold	<p>Data calls cannot be put on hold.</p> <p>2B data video calls require both B-channels at a video workstation.</p>

Last Number Dial	Terminal adapters can use Last Number Dial by dialing the Last Number Dial feature code. Last Number Dial can be activated by video systems that can dial strings and feature codes that begin with #.
Messaging	Messaging features are not available for data or video extensions, but they can be used by telephones at these workstations.
Multi-Function Module	An MFM cannot be used to connect a digital communications device or videoconferencing system.
Night Service	If a digital communications device or videoconferencing system is a member of the Night Service group, voice calls to the Night Service group do not ring at these extensions. Data or video calls do ring, and 2B data calls can be established. However, if there are two or more 2B data extensions receiving Night Service calls, the two 1B data calls that form a 2B data call may be directed to different extensions instead of the same one during Night Service operation.
Paging	Digital communications devices and videoconferencing systems can be assigned to paging groups. However, they should not be: they are not alerted if there is a call to a paging group, and they cannot make group pages.
Park	Data calls cannot be parked.
Personal Lines	<p>Personal lines can be assigned to digital communications devices and videoconferencing systems, which ideally should not share personal lines except with extensions at the same workstations. If they do share personal lines, the system manager should ensure that enough idle lines</p> <p>are available, particularly when a video system is receiving 2B data calls. Otherwise, the video system may receive only 1B data while another extension is using a second personal line.</p> <p>When a personal line is shared between a digital data device and a telephone, voice calls are directed only to the telephone, and data calls are received only by the digital communications device.</p> <p>Personal lines can be shared between an MLX telephone and a digital communications device connected to the MLX adjunct extension, provided that the communications device supports this capability.</p>
Pickup	A digital communications device can pick up a data call. Pickup is not recommended at video system extensions.
Pools	If a videoconferencing system is programmed to have a single Pool button, two calls to that pool result in a 1B data call. However, if two separate pools are assigned to a videoconferencing system extension, then a 2B data call can be established. If a system includes two or more video systems sharing the same pools, incoming 2B data calls can be misrouted.

Privacy	Privacy is activated automatically for digital data calls.
Reminder Service	Digital communications devices and videoconferencing systems cannot receive reminder calls.
Remote Access	Data calls cannot be made into lines programmed for remote access.
Ringling Options	Personalized ringing has no effect on digital data calls. Some terminal adapters follow programmed ringing options and should be set to Immediate Ring. Videoconferencing systems are not affected by ringing options.
Signal/Notify	Signaling can be activated by video systems that have the ability to dial strings and feature codes beginning with #.
Speed Dial	Personal and System Speed dial codes can be used on digital communications equipment (DCE). Speed Dial codes can be used only on digital video systems that have the ability to dial feature codes or number strings that begin with #.
System Access/ Intercom Buttons	Data calls cannot be presented as voice calls, although digital equipment can make calls using ICOM or SA Voice Announce buttons.
Tandem Switching	In Release 6.0 and later systems (Hybrid/PBX mode only), digital data calls between networked systems must travel over PRI tandem trunks or T1-emulated tie data tandem trunks. 2B data is supported when two B-channels or T1 channels are available. Digital data calls can take place at 64- and 128-kbps data speeds over tandem PRI trunks that are routed for data-only or voice/data operation. T1-emulated tie data tandem facilities are UDP-routed for data only; 56- and 112-kbps data speeds are supported on these facilities.
Transfer	Data calls cannot be transferred. 2B data video calls require both B-channels at a video workstation.
Voice Announce	Voice Announce should be disabled at digital data workstations.

Direct-Line Console

At a Glance

Users Affected	DLC operators only
Reports Affected	System Information (<i>SysSet-up</i>), Operator Information, Extension Information
Modes	All
Telephones	
MLX	MLX-20L, MLX-28D®
Analog Multiline	BIS-22D, BIS-34, BIS-34D, MERLIN II System Display Console
System Programming	<p>Assign or remove an individual DLC position:</p> <ul style="list-style-type: none"> ■ Operator→Positions→Direct Line→Store All <p>Enable or disable DLC operator automatic Hold systemwide:</p> <ul style="list-style-type: none"> ■ Operator→DLC Hold <p>When one-touch Transfer is programmed, select either automatic or manual completion for system operators:</p> <ul style="list-style-type: none"> ■ Options→Transfer→One Touch→Transfer <p>Change the duration of the timer signaling a call still on hold:</p> <ul style="list-style-type: none"> ■ Operator→Hold Timer
Maximums	
Operator positions (total DLCs and QCCs)	8
DLCs for each module	2
MLX Display Labels	See “Display” on page 271 .
Factory Settings	
Personal Lines	
MLX DLC	Lines 1–18
Analog DLC	Lines 1–32
DLC Operator Automatic Hold	Disabled
Operator Hold Timer	60 sec (range 10–255 sec)
One-Touch Transfer with Automatic Completion	Enabled
Primary System Operator Position	First (lowest) jack on first MLX or analog extension module, fixed
Park Zone Extensions	881–888

Description

A Direct-Line Console (DLC) is an answering position that system operators use to:

- Answer outside calls that are not directed to an individual user or group.
- Answer inside calls.
- Transfer inside and outside calls to local or non-local extensions or to an outside telephone number.
- Make outside calls, for example, for users with extensions restricted from making outside calls.
- Set up conference calls.
- Monitor system operation.
- Monitor group member or room status when used with Extension Status in calling group Call Management System (CMS) or Hotel mode.

A DLC operates like other multiline telephones. In all three modes of operation, outside lines are assigned as personal lines to individual buttons on the console. The lines assigned on an individual DLC can also be assigned to buttons on other consoles or other extensions. Incoming calls can ring on any of the line buttons, and several calls can ring simultaneously. The operator uses the Transfer button to direct calls to other extensions or outside numbers.

In Release 6.0 and later systems (Hybrid/PBX mode only), private networked trunks must not be programmed on a DLC as personal lines. DLC operators can call UDP extensions by using an SA button.

When programmed systemwide, DLC operator automatic Hold puts an active call on hold when a DLC operator presses another line button. When one-touch Hold is programmed systemwide and the DLC operator is on a Personal Line, pressing an Auto Dial button or DSS button also puts an active outside call on hold. Both of these Holds speed call handling and prevent accidental disconnection of callers. A DLC operator hears an abbreviated ring as a reminder of a call on hold every time the interval programmed for the operator hold timer (10–255 seconds) expires.



NOTE:

In Release 6.0 systems (Hybrid/PBX mode only), a DSS button or an inside Auto Dial button cannot be used to access a non-local extension. A programmed outside Auto Dial button can be used for this purpose.

In Release 6.1 and later systems (Hybrid/PBX mode only), a DSS button can be used to access a non-local extension, but an inside Auto Dial button cannot. No busy indication, however, appears on the DSS for a non-local extension.

A multiline telephone, assigned as a DLC through system programming, can use both operator features and telephone features available for non-operator multiline telephones to increase call-handling efficiency. The operator features that can be assigned to buttons on the console are Alarm, Night Service, Missed Reminder, and Send/Remove Message.

On a system with 29 or fewer lines, Alarm, Night Service, and Send/Remove Message are assigned, by default, to analog DLCs on buttons 32–34. On a system with more than 29 lines, Alarm is replaced with line 30, Night Service is replaced with line 31, and Send/Remove Message is replaced with line 32. The first 18 lines on an MLX DLC are always factory-set as personal lines.

Each MLX DLC can have one or two Direct Station Selector (DSS) adjuncts attached. A DSS cannot be attached to an analog DLC; however, the MERLIN II System Display Console provides a built-in DSS.

Inside Auto Dial buttons can also be programmed on DLCs. The operator can use these buttons to transfer a call to a local extension, make an inside call, or determine whether a local extension has Do Not Disturb turned on.

Considerations and Constraints

The maximum number of DLC operator positions is eight. These can be all DLCs or a mixture of DLCs and QCCs. When both DLCs and QCCs are assigned, no more than four can be QCCs. In a system with both DLC and QCC positions, the *primary system operator position* must be a QCC. The primary operator position is the first (lowest) jack on the first MLX or analog extension module.

Only multiline telephones connected to the first and fifth extension jacks on an MLX or analog module can be assigned as DLCs. This includes DLC positions used for calling group supervisors and Call Management System (CMS) supervisors.

A maximum of two DLCs can be assigned for each MLX or analog extension jack module.

A DLC cannot be located off premises.

When only DLCs (and not QCCs) are assigned, the first DLC connected to the control unit is the primary system operator position. When the system is first connected, all Dial 0 calls, invalid destination calls from remote access users, and unassigned DID calls are directed to this position. Call Management System

equipment is connected to analog extension jacks that are assigned as DLCs. Two DLCs on the same module must be assigned for each CMS (maximum of two) connected to the system.

In Release 3.1 and later systems, if an extension is changed from a Direct-Line Console to a QCC, pool dial-out codes are disallowed on the QCC. You must use system programming to allow the use of pool dial-out codes on the QCC.

Mode Differences

Hybrid/PBX Mode

If QCCs are assigned with DLCs, a QCC must be connected to the first extension jack on the first MLX module in the first carrier as the primary system operator position.

Pool buttons cannot be assigned on a DLC; however, lines/trunks included in a pool can be assigned as personal line buttons on a DLC. In Release 6.0 and later systems (Hybrid/PBX mode only), private trunks must not be assigned as personal lines on a DLC.

Lines that are not assigned to buttons on the DLC can be selected by the operator only by dialing the pool dial-out code from the SA button or, on an MLX DLC, by selecting a DSS button for the pool dial-out code. In Release 6.0 and later systems (Hybrid/PBX mode only), a DLC should not be given dial access to private trunk pools.

Lines that are not assigned to a pool cannot be selected from a DLC unless they are assigned to buttons on the console. Shared SA buttons cannot be assigned to DLCs.

Key and Behind Switch Modes

Only DLCs (not QCCs) are allowed in Key and Behind Switch modes.

A DLC operator cannot select lines that are not assigned to buttons on the console.

Telephone Differences

MLX Telephones

An MLX-20L assigned as a DLC can also be used for system programming by connecting it to any of the first five extension jacks on the first MLX module and designating the extension jack for system programming. The Home screens of the MLX-20L and MLX-28D are the same as those of non-operator telephones.

The built-in DSS field on the MERLIN II System Display Console corresponds to physical extension jacks in the control unit, instead of specific extension numbers in the numbering plan. Therefore, DSS buttons on the MERLIN II System Display Console cannot be used to monitor the busy status of pools or calling groups or to place or transfer calls to a non-local extension.

All Dial 0 calls are directed to the QCC queue and do not ring at any DLC positions. A DLC cannot use Position Busy, which is available only for QCCs. A DLC cannot be assigned as a position-busy backup for a QCC. (Only calling groups can provide backup for a QCC.)

Analog Multiline Telephones

An analog DLC cannot be used for system programming.

Feature Interactions

Alarm A DLC operator uses an Alarm button to monitor system operation. The red LED next to the Alarm button on the operator console goes on when the system detects a problem that requires immediate attention. An operator with an MLX DLC can use Inspect to display the number of alarms; an operator with an analog DLC cannot use Inspect. On a system with fewer than 29 lines, an Alarm button is factory-assigned to analog DLCs with 34 or more buttons.

On a system with more than 29 lines, the Alarm button is replaced with the line 30 button. The Alarm button is not a fixed feature and can be assigned to any available button on an analog or MLX DLC.

Allowed/Disallowed Lists Allowed and Disallowed Lists can be assigned to DLCs.

Auto Dial An inside Auto Dial button can be programmed on a DLC. A DLC operator can use the button to transfer a call, make an inside call, or determine whether or not the extension is available.

Calling Restrictions Calling restrictions can be assigned to DLCs. This helps to prevent users from bypassing restrictions on their extensions by asking system DLC operators with unrestricted consoles to connect them to an outside call.

- Call Waiting and Camp-On** When a DLC operator uses Camp-On to transfer a call to a busy extension, the call is placed in the call-waiting queue and the caller hears the call-waiting tone, whether or not the extension has Call Waiting activated. If the system is programmed for one-touch Transfer with automatic completion, the operator uses Camp-On by pressing the Transfer button, dialing the extension manually, activating Camp-On, hanging up, and pressing either another line button or the Transfer button again. If the operator presses an inside Auto Dial or DSS button, the transfer is automatically completed and Camp-On cannot be used.
- Coverage** A DLC can be both an Individual or Group Coverage receiver and a member of a coverage group. No more than eight Primary Cover, Secondary Cover, or Group Cover buttons can be assigned on a DLC. A DLC can also be a sender.
- When a DLC is used in a system with a CTI link and is not itself using a CTI link application (that is, the DLC is unmonitored), calls transferred from a Cover button on the DLC do not initiate screen pop, even at screen pop capable destinations.
- CTI Link** A DLC's SA calls can be controlled by a CTI application. When they are, the DLC position functions like any other MLX or analog multiline extension and is using a CTI application. An outside call to the position initiates screen pop at the DLC extension.
- Calls to DLCs not using a CTI application do not initiate screen pop at the operator extension; however, when transferred or conferenced—even if they arrive on the DLC's personal line button—they do initiate screen pop at a destination extension using a CTI application. Calls transferred from a DLC's programmed Cover button, also do not initiate screen pop, even at destination extensions that support screen pop.
- Directories** An operator with an MLX DLC can use all Directory features.
- Do Not Disturb** The green LED next to an Auto Dial or DSS button on a DLC turns on when a user activates Do Not Disturb. In Release 2.0 and later systems, an operator can inspect a DSS button with a red LED on to see whether the local extension is busy or using Do Not Disturb. If the user at the extension has turned on Do Not Disturb, the Do Not Disturb message is posted and appears on the operator's display. The message may also mean that the user has posted the message without turning on the feature.
- Extension Status** Extension Status capability can be assigned to DLCs only. In Hotel configuration, only a DLC operator can change an extension to Status 0. In the Group Calling/Call Management System configuration, a calling group or CMS supervisor uses a DLC to monitor and change group member status.

Forward and Follow Me

A DLC operator can forward calls to local and non-local extensions and, if the capability is assigned in system programming, to outside telephone numbers. In Key mode, because outside lines are assigned as personal line buttons on the console, the ability to forward calls received on each outside line (excluding loop-start lines with unreliable disconnect) to an outside number must also be assigned by system programming; it can be assigned to only one telephone for each individual line/trunk. In addition, the DLC must be designated as the principal user. In Hybrid/PBX mode, it can be assigned to multiple telephones for each pool.

Group Calling

A DLC can be a member of a calling group; it is used in the calling group supervisor position.

Hold

When programmed systemwide, DLC operator automatic Hold places an active call on hold when a DLC operator presses another line button. How Hold works depends on the type of call and its appearance on the telephone:

- When one-touch Hold is programmed systemwide and the operator is active on a Personal Line, pressing an Auto Dial button or DSS button also puts the call on hold. This prevents accidental disconnection of callers and speeds call handling. If the operator is active on an inside call and the call is on hold, the DLC operator hears an abbreviated ring as a reminder each time the interval programmed for the operator hold timer (10–255 seconds) expires.
- If the operator is active on an inside or outside call on an SA button, pressing an Auto dial button or a DSS button does not place the call on hold. The user at the extension associated with the Auto Dial or DSS button hears the manual signaling beep.
- For Release 6.1 systems (Hybrid/PBX mode only), if, while on an inside or outside call on an SA button with one-touch Hold enabled, a DLC operator presses a DSS button for a non-local extension, the call is not placed on hold, and the extension is not dialed. If, however, while on an outside call on a Personal Line button with one-touch Hold enabled, a DLC operator presses a DSS button for a non-local extension, the call is placed on hold and the non-local extension is dialed.

Messaging

The Send/Remove Message feature is only for operators. It is used by a DLC operator to turn on the Message LED to indicate a waiting message. For telephones without a display, the Send/Remove Message is the only way the Message LED can be turned on and off by operators. The Send/Remove Message button is factory-assigned to analog DLCs on button 34. The Send/Remove Message button is replaced with line 32 when the system has more than 29 lines. The Send/Remove Message can be assigned to any available button on an analog or MLX DLC.

Multi-Function Module

An MFM cannot be assigned as a DLC position.

- Night Service** A Night Service button is assigned only to operators and is used to activate and deactivate Night Service. It is factory-assigned to analog DLCs on button 31. On a system with more than 29 lines, the Night Service button is replaced with line 31. The Night Service button can be assigned to any available button on an analog or MLX DLC.
- Paging** A line/trunk jack programmed for Loudspeaker Paging can be assigned to a button on an analog or MLX DLC for one-touch access. An MLX DLC operator can also access a loudspeaker paging system by dialing the line number (801–880) for the line/trunk jack of the loudspeaker system.
- Park** Eight park zone codes (factory-set extension numbers 881–888) are automatically reserved for parking calls from a DLC. These numbers cannot be assigned to the DSS buttons on a MERLIN II System Display Console. To assign park zones to a DSS connected to an MLX DLC, the numbers must be in the range programmed for the Page buttons. An operator can program park zone codes on inside Auto Dial buttons. An inside Auto Dial button can also be programmed with a user's or operator's own extension number; it can be used to park calls.
- Park (continued)**
- Personal Lines** In all modes, for analog DLCs, the first 32 lines connected to the system are factory set as personal lines. On MLX DLCs, the first 18 lines are automatically assigned as personal lines.
- In Release 6.0 and later systems (Hybrid/PBX mode only), private trunks must not be assigned as personal lines on a DLC.
- Pickup** A DLC can be part of a pickup group, allowing other group members to provide backup for the DLC. In turn, a DLC operator uses Pickup to answer calls on lines that are not assigned to buttons on the console.
- Pools** In Hybrid/PBX mode, a Pool button cannot be assigned to a DLC. A DLC operator accesses a pool by dialing the pool dial-out code from an SA button or, on an MLX DLC with a DSS, by pressing the DSS button associated with the pool dial-out code. Lines/trunks assigned to pools can be assigned as personal lines only on a DLC.
- In Release 6.0 and later systems (Hybrid/PBX mode only), a DLC should not be given dial access to private trunk pools, nor should these trunks be assigned as personal lines on a DLC.
- Reminder Service** DLC operators can use Reminder Set to set or cancel reminders directed to other users. The operator can also see when a reminder has been missed, because the user did not answer the call, and then cancel the missed reminder. The Missed Reminder feature can be used only at operator positions.
- Remote Access** Invalid remote access calls can be programmed to ring on an SA or ICOM button on a DLC.
- Service Observing** In Release 6.1 and later systems, a DLC MLX telephone can be a Service Observer and can be a member of a Service Observing group.

Features

Direct-Line Console

239

Speed Dial	System Speed Dial numbers can be programmed from the first DLC connected to the first (lowest) analog extension jack on the module in slot 01 of the control unit.
System Access/ Intercom Buttons	Shared SA buttons cannot be assigned to DLCs.
Transfer	A DLC operator uses Transfer to direct calls to other users. See “Transfer” on page 723 for further information.
UDP Features	<p>In Release 6.0 and later systems (Hybrid/PBX mode only), outside Auto Dial buttons can be programmed with non-local extension numbers.</p> <p>In Release 6.1 and later systems DSS buttons can be programmed with non-local extensions. No busy indication, however, appears on the DSS for those non-local extensions.</p>

Direct Station Selector

At a Glance

Users Affected	Operators
Reports Affected	Operator Information
Modes	All
Telephones	MLX-20L, MLX-28D
System Programming	Assign extension numbers selected when DSS buttons are pressed: ■ SysRenumber→Single→More→DSS Button
Maximums	16 DSSs for each system 2 DSSs for each console (1 for each console if 3 or more consoles in one carrier) 150 extension numbers for each DSS (3 pages of extension numbers, 50 extension numbers for each page)
Factory Settings	
Page 1 button	Starts with Extension 0
Page 2 button	Starts with Extension 50
Page 3 button	Starts with Extension 100

Description

One or two Direct Station Selectors (DSSs) can be connected to an MLX-20L or MLX-28D telephone assigned as an operator position. The DSS enhances the call-handling capabilities of an operator with a Direct-Line Console (DLC) or a QCC. When connected to an MLX-20L telephone used as a system programming console, the DSS facilitates system programming and centralized telephone programming procedures. When used with the Extension Status feature or by a calling group or Call Management System (CMS) supervisor, the DSS allows you to determine, at a glance, calling group or CMS group member status or room status.

The DSS provides the following call-handling capabilities or information:

- One-touch dialing of inside extensions
- One-touch Transfer
- One-touch Hold (DLC only)
- On-hook, off-hook, or Do Not Disturb status of extensions in the system
- Extension status indication (group member or room status)
- Calling group queue status

- Message-waiting LED status
- Operator park zones
- Dialing of non-local extensions (Release 6.1 and later systems)

The DSS, shown in [Figure 15](#), has an array of 50 buttons, called *DSS buttons*, with red LEDs. A maximum of two DSSs can be connected to provide a field of 100 buttons. Ten additional fixed-feature buttons with green LEDs are at the bottom of the DSS. The first three (from left to right) on the top row are Page buttons, which are used to select the range of extension numbers represented by the DSS buttons. A fourth button (lower leftmost) is the Message Status button, which is used to turn the message status operation on and off. When you are using the Message Status feature, the LED next to each DSS button for a local extension indicates whether or not a message is waiting from a system operator. The remaining six buttons on the first DSS and the 10 buttons at the bottom of the second DSS are not operable (reserved for future use), except on a QCC, where the rightmost button on the second to last row of the first DSS activates the Direct Voice Mail feature for local extensions.

A page is a range of extension numbers assigned to a DSS. A single DSS can have three pages of extension numbers, with 50 extension numbers for each page, for a total of 150 extension numbers. When two DSSs are connected, each page's capacity is increased to 100 extension numbers. The two connected DSSs can have three pages of extension numbers for a total of 300 extension numbers.

The beginning number for each page is assigned through system programming. When an operator presses a Page button, the page of the DSS corresponds to a range of 50 (for a single DSS) or 100 (for two connected DSSs) extension numbers. The factory settings for Page buttons are as follows: the Page 1 button begins with Extension 0; the Page 2 button begins with 50; and the Page 3 button begins with 100.

If only one DSS is attached, each Page button assignment sets the console for a range of 50 extension numbers. If two DSSs are attached, each Page button assignment sets the console for a range of 100 extension numbers. If two DSSs are used, the factory setting *must* be changed so that the difference between extensions assigned to the range is at least 100. For example, for a three-digit dial plan, assign Page 1 button to begin with Extension 100, Page 2 button to begin with Extension 200, and Page 3 button to begin with Extension 300. For a four-digit dial plan, assign Page 1 button to begin with Extension 1000, Page 2 button to begin with Extension 1100, and Page 3 button to begin with Extension 1200.

The beginning extension number associated with each Page button is the same for all operator positions and cannot be programmed differently for individual operator positions.

Each Page button range can begin with any extension number that is a multiple of 50, in the range of 0 to 9950. To speed call handling, however, the assignments should be sequential; the range starting with the lowest extension number should be assigned to Page 1, the range starting with a higher extension number should be assigned to Page 2, and the range starting with a still higher extension number should be assigned to Page 3. You cannot program individual buttons on a DSS.

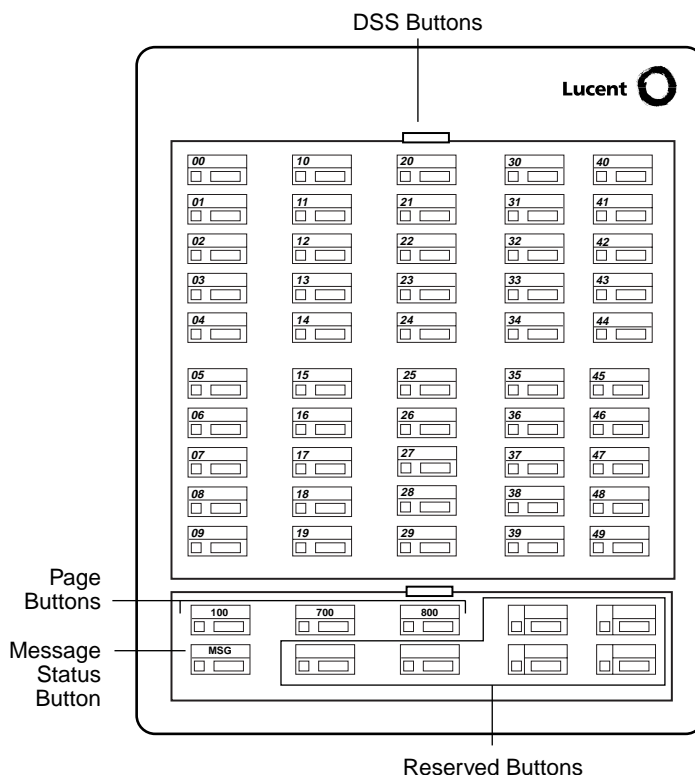

Figure 15. Direct Station Selector (DSS)

Each of the 50 DSS buttons corresponds to one of three extension numbers. The specific extension number is determined by the Page button that is pressed. For example, if the first extension number for the Page 1 button is programmed to be Extension 100, the DSS buttons and associated LEDs on a single DSS correspond to local Extensions 100 to 149. The specific extensions represented by each DSS button are assigned from top to bottom, and left to right, as shown in [Figure 15](#). On a QCC, the upper right reserved button is used for voice announcements.

A DSS button can represent one of the following:

- Local extension number
- Non-local extension number
- Line/trunk number (801–880)
- Pool dial-out code (Hybrid/PBX mode only)
- Calling group extension number
- Paging group extension number
- Operator park zone extension number
- Access code (usually 9) for ARS or Idle Line Preference
- Remote access dial code
- LDN (the extension for the QCC queue)

The use and definition of each DSS button's LED depend on the local extension represented by the button and whether the operator position is used for normal call handling, calling group or CMS supervisory operation, Extension Status in Hotel configuration, or message status operation. See [“Extension Status” on page 317](#) and [“Group Calling” on page 350](#) for additional information.

Normal Call-Handling Operation

Normal call-handling operation is active when the position is not in Message Status or Extension Status operation. The DSS buttons are used for one-touch dialing of local or non-local extension numbers. When a button for a local or non-local telephone extension, local or non-local calling group extension, or local paging group extension is pressed, the extension number is dialed automatically. In Hybrid/PBX mode, a specific pool can be selected by pressing the DSS button for a local pool dial-out code or dialing the local ARS code by pressing the DSS button for the ARS code. If, before lifting the handset, a DSS button is pressed for any of the extensions or codes mentioned above, the speaker is turned on automatically and an SA or ICOM button is selected.

A DSS button is also used to activate a feature that requires a local extension number—for example, Barge-In, Conference, Send/Remove Message, Forward (including Remote Call Forwarding), Follow Me, Leave Message, Reminder service, and Transfer. To do this, the Feature button is pressed, the feature code dialed, and the DSS button for the extension number selected.

The result of pressing a DSS button while on a call depends on the type of operator position, the type of button pressed, and whether the system is programmed for one-touch Hold or one-touch Transfer, as described in [Table 10](#) and [Table 11](#), which follow. For a QCC operator position, see [Table 12](#).

Table 10. Results of Pressing DSS Button while Active on a Call: DLC Position with One-Touch Hold

Extension Type	Result
Individual, calling group, paging group	<p>An outside caller is put on hold, an SA or ICOM button is selected automatically, and the extension number is dialed automatically. Transfer is not completed automatically.</p> <p>How Hold works depends on the type of call and its appearance on the telephone:</p> <ul style="list-style-type: none"> ■ When one-touch Hold is programmed systemwide and the operator is active on a Personal Line, pressing an Auto Dial button or DSS button also puts the call on hold. This prevents accidental disconnection of callers and speeds call handling. If the operator is active on an inside call and the call is on hold, the DLC operator hears an abbreviated ring as a reminder each time the interval programmed for the operator hold timer (10–255 seconds) expires. ■ If the operator is active on an inside or outside call on an SA button, pressing an Auto dial button or a DSS button does not place the call on hold. The user at the extension associated with the Auto Dial or DSS button hears the manual signaling beep. ■ For Release 6.1 systems (Hybrid/PBX mode only), if, while on an inside or outside call on an SA button with one-touch Hold enabled, a DLC operator presses a DSS button for a non-local extension, the call is not placed on hold, and the extension is not dialed. If, however, while on an outside call on a Personal Line button with one-touch Hold enabled, a DLC operator presses a DSS button for a non-local extension, the call is placed on hold and the non-local extension is dialed.
Pool dial-out code or ARS code	<p>Pool dial-out codes and ARS codes apply to local extensions only. The caller is put on hold, transfer is initiated, the pool dial-out code or ARS code is automatically dialed, and the operator can then dial the outside telephone number. Transfer completion is always manual—the operator must press another button or hang up to complete the transfer.</p>

Table 10. Results of Pressing DSS Button while Active on a Call: DLC Position with One-Touch Hold — *Continued*

Extension Type	Result
Park zone	Park zone applies to local extensions only. The Park feature is activated, and the call is put on hold on the selected park zone to allow Pickup from any extension in the system.
Line/trunk number, LDN, unassigned extension numbers, dial 0 calls	Ignored; no effect.

Table 11. Results of Pressing DSS Button while Active on a Call: DLC Position with One-Touch Transfer

Extension Type	Result
Individual or calling group	The caller is put on hold, transfer is initiated, an SA or ICOM button is selected automatically, and the extension number is dialed automatically. If manual completion is programmed, an operator must press another button or hang up to complete the transfer. If automatic completion is programmed, the transfer is completed automatically.
Pool dial-out code or ARS code	The caller is put on hold, the transfer is initiated, the pool dial-out code is automatically dialed, and the operator can then dial the outside telephone number. Transfer completion is always manual; the operator must press another button or hang up to complete the transfer, whether the system is programmed for manual or automatic completion.
Paging group	The caller is put on hold, an SA or ICOM button is selected automatically, and the paging group extension number is dialed automatically. Transfer is not completed automatically, whether the system is programmed for one-touch Hold or one-touch Transfer, because calls cannot be transferred to a paging group.
Park zone	The Park feature is activated, and the call is put on hold in the selected park zone to allow Pickup from any extension in the system.
Line/trunk number, LDN, unassigned extension numbers, dial 0 calls	Ignored; no effect.

Table 12. Results of Pressing DSS Button while Active on a Call: QCC Position

Extension Type	Result
Individual or calling group	The caller is put on hold, the transfer is initiated, and the extension is dialed automatically. If extended call completion is programmed with the Manual option, the operator must press the Release button or hang up to complete the transfer. If extended call completion is programmed with the Automatic option, the transfer is completed automatically.
Pool dial-out code or ARS code	The caller is put on hold, the transfer is initiated, and the pool dial-out or ARS code is dialed automatically. The operator can then dial the telephone number. Transfer completion is always manual whether extended call completion is programmed as manual or automatic.
Paging group	The caller is put on hold, a Call button is automatically selected, and the paging group extension number is automatically dialed. The call transfer process is not initiated automatically because calls cannot be transferred to a paging group.
Park zone	The Park feature is activated, and the call is put on hold in the selected park zone to allow Pickup from any extension in the system.
Line/trunk number, LDN, unassigned extension numbers, dial 0 calls	Ignored; no effect.

The red LEDs for each DSS button are used to determine whether a user is on a call (off hook), has no call active (on hook), or is using Do Not Disturb. The LED indication (on) is the same for off hook and Do Not Disturb; however, in Release 2.0 and later systems, the DSS button can be inspected to determine whether the user is on a call or has activated Do Not Disturb.

For a calling group extension on a DSS button, the red LED indicates the status of the queue. In Release 5.0 and later systems, the DSS button flashes if the number of calls waiting in the queue is greater than or equal to Threshold 1 but fewer than Threshold 3. The LED lights steadily if the number of waiting calls is greater than or equal to Threshold 3. If three thresholds are needed, an inside Auto Dial button should be used to monitor queue status.

For a pool dial-out code on a DSS button, the red LED indicates line/trunk availability.

In Release 6.1 and later systems pressing a DSS button for a non-local dial plan extension will cause the appropriate routing pattern and route to be chosen. The

DSS LED associated with the non-local dial plan are not updated for any feature including switchhook operation, therefore the extinguished appearance for a non-local dial plan extension does not indicate the true state of the extension. Do Not Disturb information is not conveyed because the LED is extinguished. Using the Inspect button only provides the extension number for a non-local dial plan extension. If the facilities are busy that are needed to make the call to the non-local dial plan extension associated with the pressed DSS button, the call is queued. The called MERLIN LEGEND blocks calls to the non-local dial plan Paging groups, and if an attempt is made to use the console to activate a feature associated with a remote extension, the feature generally will not work.



Also in Release 6.1 and later systems, a called switch may not act on an external call from a DSS button on another MERLIN LEGEND System. For example, a page may not be connected at the called extension.

[Table 13](#) shows the meanings of the red LEDs for DSS buttons for local extensions while the operator position is in normal operation and message status is not active. [Table 13](#) does not apply to non-local extensions.

Table 13. ED Meanings for Normal Call-Handling Operation

LED Status	Extension Type	Meaning
Off □	Individual	The person is not on the telephone and is not using Do Not Disturb.
	Line/Trunk number	The line/trunk is not in use. The LED is always off for a DID trunk or a Switch 56 trunk on a DLC.
	Pool dial-out code	At least one line/trunk is available for making an outside call.
	Calling group	The calling group queue is below the programmed threshold (in Release 5.0 and later systems, below Threshold 1).
	Paging group	The group is available for making a group announcement.
	Operator Park Zone	A call is not parked on this park zone code.
	ARS, Remote access, LDN	Not applicable; the red LED is always off.
On ■	Individual	The person is on the telephone or has activated the Do Not Disturb feature.
	Line/trunk number	The line/trunk is in use. No indication appears for a busy DID trunk or Switch 56 trunk on a DLC.
	Pool dial-out code	No lines/trunks are available in this pool for outside calls.

Table 13. ED Meanings for Normal Call-Handling Operation — Continued

LED Status	Extension Type	Meaning
On 	Calling group	The calling group queue is at or above the allowable threshold (in Release 5.0 and later systems, at or above Threshold 3).
	Paging group	An announcement is being made to a paging group.
	Operator Park Zone	A call is parked in this park zone.
	ARS, Remote Access, LDN	Not applicable; the red LED is always off.
Fast flashing 	Individual	The person is calling the system operator position.
Slow flashing 	Individual	A call transferred by the system operator to the extension is returning.
	Calling group	The group queue is at or above Threshold 1 and below Threshold 3 (Release 5.0 and later systems).
	Line/trunk number	A call is ringing on this line/trunk. No indication appears for a busy DID trunk or Switch 56 trunk on a DLC.



NOTE:

Fast flashing is applicable only to DSS buttons for individual extensions. Slow flashing is applicable to DSS buttons for individual extensions, calling group extensions, and line/trunk numbers.

Calling Group or CMS Supervisory Operation



A supervisor with a DLC switches from normal call handling to supervisor operation by pressing the Feature button, dialing 32, and pressing the Hold button. The effect of pressing a DSS button while in supervisor operation is the same as that described for normal call-handling operation. See [“Group Calling” on page 350](#) for additional information.

When the supervisory position is not in Message Status operation, the green LED next to the Message Status button is off. The red LED next to each DSS button for a calling group member’s extension is used to monitor the availability of members to take calls directed to the calling group.

In Release 6.1 and later systems Calling Group and CMS Supervisor Operation is only available for local extensions.

The meaning of the red LED associated with each group member is shown in [Table 14](#).

Table 14. LED Meanings for Supervisor Operation without Message Status Active

LED Status	Extension Status	Meaning
Off 	0	The extension is signed out from the group, and the member is unavailable to take calls.
On 	2	The extension is signed into the group, and calls can be sent to the member.
Slow Flashing 	1	Used for CMS only; the extension is in the after-call work state, and the group member is not available to take calls.



NOTE:

The LEDs next to DSS buttons for all other types of extensions are always off and have no meaning.

Extension Status Operation (Hotel Configuration)



When Extension Status is in Hotel configuration, the Extension Status feature is assigned to and removed from individual DLCs through system programming (see [“Extension Status” on page 317](#) for details). Hotel Extension Status operation is always active, unless the Message Status button has been pressed to use the Auto Dial or DSS buttons to see the message-waiting status for each extension. Pressing a DSS button while in Hotel Extension Status operation has the same effect as for normal call-handling operations.

When not in Message Status operation, the red LED next to each DSS button for a room extension is used to monitor room availability, and the DSS button is used to restrict the extensions when the rooms are not occupied.

In Release 6.1 and later systems Extension Status Operation is available only for local extensions.

The meaning of the red LED next to the DSS button for each room is shown in [Table 15](#).

Table 15. LED Meanings for Hotel Extension Status Operation without Message Status Active

LED Status	Extension Status	Meaning
Off 	0	The room is occupied, and the extension is in regular call-handling state.
On 	2	The room is vacant and available for occupancy, and outside calls cannot be made from the extension.
Slow flashing 	1	The room is vacant and ready for cleaning. Outside calls cannot be made from the extension.



NOTE:

The LED next to the DSS button for all other types of extensions is always off and has no meaning.

Message Status Operation

Message Status operation is activated when the Message Status button is pressed (the lower left feature button on the first DSS) while in normal call-handling, calling group, CMS supervisory, or Extension Status operation. The green LED next to the Message Status button is on when Message Status operation is active.

While the position is in Message Status operation, the red LEDs next to the DSS buttons for user extensions indicate whether or not the Message LED has been turned on by a system operator. They do not light when a Message LED has been turned on by another source, such as a fax machine or another user. An LED associated with a calling group extension or a pool dial-out code is always off while the position is in Message Status operation.

If an operator wants to turn on the message-waiting LED to indicate that a message is waiting, the operator first checks the LED next to the recipient's DSS button to determine whether or not the recipient's message-waiting LED is on. The operator's DSS or console LEDs do not light when a message-waiting LED has been turned on by another source, such as a fax machine or another user. To leave a message-waiting indication when the LED is apparently off, the operator presses the programmed Send/Remove Message button, followed by the DSS button or Auto Dial button for the person for whom the message is intended. The operator presses the Message Status button to return to normal call handling.

By pressing the Feature button and selecting `Leave Msg` from the display, MLX DLC operators can leave a message at another extension. This does not affect

Message Status operation because Message Status shows only messages sent with the Send/Remove Message button. See [“Messaging” on page 429](#) for more information about sending and receiving messages.

For calling group or CMS supervisory operation or for Hotel Extension Status in Message Status operation, the red LED next to a DSS button for a user extension indicates whether or not a message has been sent by any of the operator positions. On a button for a calling group extension number, the red LED indicates the status of the queue. When a DSS button stores a pool dial-out code, the red LED indicates line/trunk availability.

In Release 6.0 and later systems, Message Status Operation is only available for local extensions.

The meanings of the red LEDs next to the DSS buttons while the operator position is in Message Status operation are shown in [Table 16](#) and [Table 17](#).



Table 16. LED Meanings for Hotel Extension Status Operation with Message Status Active

LED Status	Extension Type	Meaning
Off <input type="checkbox"/>	Individual	A system operator has not turned on the Message LED.
On <input checked="" type="checkbox"/>	Individual	A system operator has turned on the Message LED to indicate a waiting message.
Off <input type="checkbox"/>	All other types of extensions	No meaning

Table 17. LED Meanings for Supervisor or Hotel Extension Status Operation with Message Status Active

LED Status	Extension Type	Meaning
Off <input type="checkbox"/>	Individual	The person is not on the telephone and is not using Do Not Disturb.
	Line/trunk number	The line/trunk is not in use. The LED is always off for a DID trunk or a Switch 56 trunk on a DLC.
	Pool dial-out code	At least one line/trunk is available for making an outside call.
	Calling group	The calling group queue is below the programmed threshold (in Release 5.0 and later systems, below Threshold 1).
	Paging group	The group is available for making a group announcement.
	Operator park zone	A call is not parked on this park zone code.

Table 17. LED Meanings for Supervisor or Hotel Extension Status Operation with Message Status Active — Continued

LED Status	Extension Type	Meaning
Off 	ARS, Remote Access, LDN	Not applicable; the red LED is always off.
On 	Individual	The person is on the telephone or is using Do Not Disturb.
	Line/trunk number	The line/trunk is in use. No indication appears for a busy DID trunk or Switch 56 trunk on a DLC.
	Pool dial-out code	No lines/trunks are available on this pool for outside calls.
	Calling group	The calling group queue is at or above the allowable threshold (in Release 5.0 and later systems, at or above Threshold 3).
	Paging group	An announcement is being made to the paging group.
	Operator park zone	A call is parked on this park zone code.
Slow flashing 	ARS, Remote Access, LDN	Not applicable; the red LED is always off.
	Calling group	The group queue is at or above Threshold 1 and below Threshold 3 (Release 5.0 and later systems).

Considerations and Constraints

One or two DSSs can be connected to an MLX-20L or MLX-28D telephone. DSSs cannot be connected to an MLX-5, MLX-5D, MLX-10[®], MLX-10DP[®], MLX-10D[®], MLX-16DP[®], ETR, MLS, analog multiline, or single-line telephone.

Only a DLC or QCC can have a DSS.

Operator park zone codes must be included in the extension number range specified for one of the Page buttons.

If a local extension is busy because features are being assigned through system or centralized telephone programming, the red LED next to the associated DSS button is on to indicate the busy condition.

When a QCC is active on a call, pressing a DSS button for a line/trunk number, LDN, or unassigned extension number is ignored.

In Release 6.1 and later systems a call to a non-local dial plan extension, using a DSS button at a QCC, will be automatically transferred if the extended call completion option at the QCC is programmed for Automatic Completion. If the QCC is not programmed for Automatic Completion, hangup or depression of the Release button completes the transfer. In both of the above situations, the call will be callback queued if no facilities associated with the route are available. Local dial plan extension transferring is not changed.



SECURITY ALERT:

Do not include the ARS access code in the non-local dial plan.

In Release 2.1 and later systems, when a call is forwarded to a multiline telephone that has a DSS button for the forwarding telephone, the light next to the DSS button does not flash.

DSSs that are out of the building require additional local power. Any console with two DSSs requires local power.

Mode Differences

Behind Switch Mode

In Behind Switch mode, DSS buttons for operator park zones do not work.

Feature Interactions

Automatic Route Selection

The LED next to a DSS button for the ARS code is always off. For the local system only, if the local ARS access code programmed on a DSS button is pressed, the call is set up and always requires the remaining called digits to be entered manually and the transfer to be completed manually, pressing the Release button or hanging up.

Barge-In

After making a call to an extension by using a DSS button on a DLC, activate Barge-In by pressing a programmed Barge-In button. QCC operators select the feature from the display.

Camp-On

When Camp-On is used to complete a transfer and the call returns, the LED of the DSS button associated with the extension transfer destination stays off and does not flash as it does for a transfer return.

Coverage

When an operator transfers an Individual or Group Coverage call and it returns, the red LED next to the DSS button for the sender does not flash as it does when a call received on another type of line button returns.

- Direct Voice Mail** On a QCC's DSS, the Direct Voice Mail button is a fixed button, the rightmost button in the second row from the bottom. Direct Voice Mail functions only for extensions on the same system.
- Display** When an operator presses a DSS button for a local extension number, the extension label, if any, and the extension number appear on the display while it is dialed. If the operator presses a DSS button for a non-local extension, only the extension number appears.
- Do Not Disturb** In Release 2.0 and later systems, an operator can use the Inspct button to check the status of a local extension whose red LED is on. If the user at the extension is using Do Not Disturb, the Do Not Disturb message is also posted and appears on the operator's display. (The message, however, may also mean that the user has posted the message without turning on the Do Not Disturb feature.)
- Extension Status** For a local system only, a calling group, CMS supervisor, or an operator at a DLC with Extension Status assigned can change the status of a group member or room by pressing a programmed Available or Unavailable extension status button and then pressing the DSS button for the group member or room.
- Forward and Follow Me** Activate Forward by pressing a programmed button or using a feature code, and then pressing a DSS button for the extension where calls should go. Activate Follow Me by dialing the feature code and then pressing a DSS button for the sender's extension number. This activation of Forward and Follow Me functions only for a local system.
- Group Calling** In releases prior to 5.0, the DSS button's LED for a calling group extension number indicates the status of calls in the calling group queue on a local system. The LED is on when calls are at or above the programmed threshold and off when the number is below the threshold.
- In Release 5.0 and later systems, a DSS button used as a Calls-in-Queue Alarm button indicates only two alarm threshold levels instead of the three that a programmed inside Auto Dial button can display. A DSS either flashes or lights steadily. The button is unlit when the number of calls in the queue drops below Threshold 1. The LED lights steadily when the number of calls in queue is greater than or equal to Threshold 3. Otherwise, it flashes. If DSS buttons are used to monitor calling group queue status, only two alarm thresholds should be set. This alarm functionality works only on a local system.

Headset Options

In Release 7.0 and later systems, when the headset user receives a Voice Announce call, the DSS LED for the user lights. The DSS LED remains lit when the call is switched from the speaker to the headset. When the calling party hangs up, or the headset user presses the Headset Hang-Up button, the DSS LED for the headset user turns off.

Hold

When programmed systemwide, DLC operator automatic Hold places an active call on hold when a DLC operator presses another line button. How Hold works depends on the type of call and its appearance on the telephone:

- When one-touch Hold is programmed systemwide and the operator is active on a Personal Line, pressing a DSS button also puts the call on hold. This prevents accidental disconnection of callers and speeds call handling. If the operator is active on an inside call and the call is on hold, the DLC operator hears an abbreviated ring as a reminder each time the interval programmed for the operator hold timer (10–255 seconds) expires.
- If the operator is active on an inside or outside call on an SA button, pressing a DSS button does not place the call on hold. The user at the extension associated with the DSS button hears the manual signaling beep.
- For Release 6.1 systems (Hybrid/PBX mode only), if, while on an inside or outside call on an SA button with one-touch Hold enabled, a DLC operator presses a DSS button for a non-local extension, the call is not placed on hold, and the extension is not dialed. If, however, while on an outside call on a Personal Line button with one-touch Hold enabled, a DLC operator presses a DSS button for a non-local extension, the call is placed on hold and the non-local extension is dialed.

Pressing a DSS button for a calling group, paging group, or non-local extension has no effect.

Inspect Inspect can be used to determine the corresponding extension for each DSS button. To use Inspect, press the Page button for the range of extensions, press the Inspct button, and press each DSS button to see what it represents; the label and number of messages in the mailbox are also shown. Information is displayed on only one extension at a time. To see information for another range of extensions, press the Home button and repeat the process. In Release 2.0 and later systems, if a message is posted at an extension associated with a DSS button, the message is shown on Line 2 of the display when the operator inspects the DSS button.

When an the Inspct button is pressed and then a Page button, the display shows *Page*, the page number selected, and the first extension number in the range. When the Inspct button is pressed and then the Message Status button, the display shows *Message Status* to indicate that the DSS is in Message Status operation.

When a DSS button, representing a local extension number, is pressed after pressing the Inspct button, the display shows the extension label, extension number, number of messages, and for Release 2.0 and later systems, any posted messages. If a DSS button for a non-local extension is pressed after pressing the Inspct button, only the extension number appears.

Last Number Dial An extension dialed by pressing a DSS button is not stored for Last Number Dial.

Messaging When an operator presses the Message Status button on a DSS, the LEDs for local extensions on the DSS reflect only messages left by an operator using the Send/Remove Message or Leave Message features and not messages left by any co-worker (non-operator) using the Leave Message feature.

In Release 2.0 and later systems, an operator can view a posted message at a local extension by pressing the Inspct button and then the DSS button.

Paging For local extensions only, the DSS button for a line/trunk programmed as a loudspeaker paging jack only indicates whether or not the paging system is in use. The button cannot be used to gain access to the loudspeaker paging system. It can be used only to dial an extension for a paging group. When a DSS button for a paging group is pressed, the transfer process is not initiated, even if one-touch Transfer (DLC only) or automatic extended call completion (QCC only) is programmed for the system. Calls cannot be transferred to a paging group extension number.

Park Park zone codes cannot be assigned to DSS buttons on MERLIN II System Display Consoles. In order for the park zones to be assigned to a DSS connected to an MLX telephone, the extension numbers must be in the range programmed for the Page buttons. Only DSS buttons corresponding to an operator park zone on the local system can be used to park calls; calls cannot be parked on a DSS button corresponding to any other type of extension, including an operator park zone on a remote system.

When an operator parks a call by using a park zone DSS button and the call returns, the red LED associated with the park zone where the call is parked stays off and does not flash as it does for a transfer return.

To park a call at a park zone, an operator with a DSS presses the DSS button for the park zone while the caller is on the line. If an operator tries to park a call by pressing the Transfer button followed by the DSS button for the park zone, the call is put on hold for transfer and is not parked. This error can transfer a call to an outside number.

Pickup DSS buttons associated with line/trunk numbers (801–880) cannot be used for answering calls on specific lines through individual Pickup. These DSS buttons are used only for checking the busy or not-busy status of each line/trunk on the local system.

Pool For the local system only, when the pool lines are busy, the LED next to the pool button is lit. If the pool button programmed on a DSS button is pressed, the call is set up and the pool dial-out code is dialed. However, the remaining digits must be entered manually.

Queued Call Console In Release 6.1 and later systems DSS buttons can be used to dial non-local extensions or to transfer calls. No busy indications, however, appear on the DSS for non-local extensions.

When a QCC is forced-idle, the DSS LED at another extension for the QCC does not light.

In Release 7.0 and later systems, if you go off-hook on the receiver or the speakerphone of the QCC and then press the Headset Status button to use the headset, the DSS LED for the QCC remains lit.

In Release 7.0 and later systems, if you enter programming mode while using the headset, the DSS LED at another extension for the QCC turns on. When you exit programming mode, the DSS LED remains on. If you are *not* using the headset and exit programming mode, the DSS LED turns off.

In Release 7.0 and later systems, if you are on a call using the headset, enter programming mode, and the far-end hangs up, the DSS LED turns off, even though you are still in programming mode.

- Saved Number Dial** An extension dialed by pressing a DSS button is not stored for Saved Number Dial.
- Service Observing** In Release 6.1 and later systems, a Service Observer can use a DSS button to enter a local extension number to establish an observing session.
- Signal/Notify** If a user presses a Signal button programmed with an operator's extension while making a call to the operator, the LED next to the DSS button associated with the user changes from flashing to on, while the Signal button is held down. This works only for local extensions.
- System Renumbering** The beginning extension number for each page is assigned through system programming. The factory settings are as follows: Page 1 button begins with Extension 0, Page 2 button begins with Extension 50, and Page 3 button begins with Extension 100.
- Transfer** The Transfer option of one-touch Hold applies only to outside calls on a DLC, not on a QCC.
- The operation of one-touch Hold varies according to the type of call and button appearance:
- When one-touch Hold is programmed systemwide and the operator is active on a Personal Line, pressing a DSS button also puts the call on hold. This prevents accidental disconnection of callers and speeds call handling. If the operator is active on an inside call and the call is on hold, the DLC operator hears an abbreviated ring as a reminder each time the interval programmed for the operator hold timer (10–255 seconds) expires.
 - If the operator is active on an inside or outside call on an SA button, pressing a DSS button does not place the call on hold. The user at the extension associated with the DSS button hears the manual signaling beep.
 - For Release 6.1 systems (Hybrid/PBX mode only), if, while on an inside or outside call on an SA button with one-touch Hold enabled, a DLC operator presses a DSS button for a non-local extension, the call is not placed on hold, and the extension is not dialed. If, however, while on an outside call on a Personal Line button with one-touch Hold enabled, a DLC operator presses a DSS button for a non-local extension, the call is placed on hold and the non-local extension is dialed.

Transfer
(continued)

When one-touch Hold is programmed and an operator presses a DSS button with an inside caller on the line (or, in Hybrid/PBX mode, with an outside caller on an SA button), the call is not put on hold and a signal is sent to the extension corresponding to the DSS button pressed. When one-touch Transfer (with either manual or automatic completion) is programmed and an operator presses the DSS button while the caller is on the line and no SA or ICOM button is available to transfer the call, the call does not go on hold. If the operator hangs up, the caller is disconnected.

Transfer is always initiated—and transfer completion is manual—when an operator presses the DSS button corresponding to a line/trunk number, pool dial-out code (Hybrid/PBX only), or ARS access code (Hybrid/PBX only), even if one-touch Hold, one-touch Transfer with automatic completion (DLC only), or automatic extended call completion (QCC only) is programmed for the system.

When an operator transfers an Individual or Group Coverage call and the call returns, the red LED next to the DSS button for the sender does not flash as it does for a transfer return for calls received on other types of line buttons.

When an operator transfers a call to a calling group and the call returns, the red LED associated with the calling group does not flash as it does for a transfer return from a user's extension.

UDP Features

In Release 6.0 systems (Hybrid/PBX mode only), a DSS button cannot be used for a non-local extension.

In Release 6.1 and later systems (Hybrid/PBX mode only), a DSS button can be used for a non-local extension, but no busy indication a non-local extension appears on the DSS.

Direct Voice Mail

At a Glance

Users Affected	Telephone users, operators
Reports Affected	Extension Directory
Modes	Hybrid/PBX, Key
Telephones	All
MLX Display Label	Direct VM [DrcVM]
Programming Code	*56
Feature Code	56

Description

Direct Voice Mail allows you to place or transfer a call directly to another person's voice mail without ringing that person's telephone.

You can either transfer an active call to an extension's voice mail or place an intercom call directly to the extension's voice mail. Activating Direct Voice Mail while on hook selects the next available SA or ICOM button (if at least one SA or ICOM button is available). To activate Direct Voice Mail, do one of the following:

- Press the programmed Direct Voice Mail button, and press a DSS button or Auto Dial button; or select a Directory entry for the extension.
- Press the programmed Direct Voice Mail button and dial the extension number.
- Press the Feature button, select `Direct VM [DrcVM]`, and dial the extension number.
- For a single-line telephone only:
 - If active on a call, press the Flash or Recall button (or, if your telephone does not have positive disconnect, press and release the switchhook). Then dial #56 followed by the extension number.
 - If you hear dial tone, dial #56 followed by the extension number.

On display telephones, the display shows the message `Send Voice Mail to:` before the extension is selected or dialed.

The green LED associated with the Direct Voice Mail button lights when the feature is activated. The LED turns off when the feature is deactivated (by

pressing the Direct Voice Mail button again) or when the call or transferred call has gone to voice mail.

If you have a programmed Direct Voice Mail button, you can send a call directly to voice mail while transferring or making a call by pressing the Direct Voice Mail button. The call or transferred call goes to the extension's voice mail. In this case, the green LED does not turn on.

If you activate Direct Voice Mail to transfer a call and then press the Direct Voice Mail button to deselect the feature, the original call is still on hold for transfer. You can either enter an extension number and complete the transfer to another extension (by hanging up or pressing the Transfer button) or press the line button to pick up the call.

Considerations and Constraints

You cannot place a call to your own voice mail by using Direct Voice Mail.

If you have an MLX display telephone and use the System or Extension Directory to select the extension to receive voice mail, the display does not show the message *Send Voice Mail to:*.

Mode Differences

Behind Switch Mode

Although programming a Direct Voice Mail button is allowed, the button serves no function in Behind Switch mode because no on-premises voice mail systems are supported. Direct Voice Mail does not work with a voice mail system on the host PBX or with Centrex voice mail.

Telephone Differences

Queued Call Consoles

On a QCC's DSS, the Direct Voice Mail button is a fixed button, the rightmost button in the second row from the bottom.

QCC operators may also select the feature from the display.

Single-Line Telephones

If you already hear dial tone and want to call directly to an extension's voice mail, dial #56 followed by the extension number. Single-line telephone users must press a Recall or Flash button and dial #56 to transfer a call to an extension's voice mail. If the telephone does not have positive disconnect, press and release the switchhook instead of pressing the Recall or Flash button.

Feature Interactions

Centralized Voice Messaging	You can use Direct Voice Mail (DVM) only on extensions on the same MERLIN LEGEND System. DVM does not work when you are calling a non-local extension. For example, if you are on one system and call an extension on another system, and then press the DVM button, the button press is ignored. If you call an extension on the same system and press the DVM button, the call is sent to the voice messaging system. This affects MERLIN LEGEND Systems of Release 6.1 or later.
Coverage	Direct Voice Mail overrides coverage-inhibiting features such as Coverage Off, Coverage VMS Off, and Coverage Inside Off.
Direct Station Selector	On a QCC's DSS, the Direct Voice Mail button is a fixed button, the rightmost button in the second row from the bottom.
Forward/Follow Me	<p>In Release 4.0 and later systems, if Forwarding is active and Delayed Forwarding is not set to zero rings, pressing the Direct Voice Mail button causes the call to go directly to voice mail coverage; the call does not get forwarded.</p> <p>In Release 3.0 and later systems, a call that is transferred to an extension using Direct Voice Mail is not forwarded.</p> <p>You cannot forward calls to your own extension, and you cannot use Direct Voice Mail to reach your own mailbox.</p>
Headset Options	When an MLX telephone user (other than a QCC operator) transfers a call by using Direct Voice Mail, Headset Auto Answer is turned off and must be turned on manually to resume using the feature.
Service Observing	In Release 6.1 and later systems when an extension being observed transfers a call by using Direct Voice Mail, the Service Observer is dropped from that call.
Transfer	If you have a Direct Voice Mail button, you can activate Direct Voice Mail after starting to transfer a call. While a transfer is being made, press the Direct Voice Mail button to transfer the call to the extension's voice mail. Complete the transfer as usual by pressing the Transfer button or hanging up.

Directories

At a Glance

Users Affected	Telephone users MLX display telephone users MLX-20L telephone users
<ul style="list-style-type: none"> System Directory Extension Directory Personal Directory 	
Reports Affected	Direct Group Calling Information, Extension Directory, Label Information, System Directory, System Information (SysSet-up)
Modes	All
Telephones	MLX, analog multiline, and single-line telephones
<ul style="list-style-type: none"> System Directory Extension Directory Personal Directory 	<ul style="list-style-type: none"> MLX display telephones MLX-20L telephones
MLX Display Label	Directory, System Dir [Dir, SysDir]
<ul style="list-style-type: none"> System Directory Extension Directory Personal Directory 	<ul style="list-style-type: none"> Directory, Ext Dir [Dir, ExtDir] Directory, Per Dir
System Programming	<p>Create, change, or delete System Directory listings:</p> <ul style="list-style-type: none"> ■ More→Labeling→Directory→System <p>Create, change, or delete Extension Directory listings:</p> <ul style="list-style-type: none"> ■ More→Labeling→Directory→Extension <p>Create, change, or delete Personal Directory listings:</p> <ul style="list-style-type: none"> ■ More→Labeling→Directory→Personal <p>Assign outside line/trunk labels:</p> <ul style="list-style-type: none"> ■ More→Labeling→LinesTrunks <p>Assign calling group labels:</p> <ul style="list-style-type: none"> ■ More→Labeling→Grp Calling
Maximums	
<ul style="list-style-type: none"> System Directory 	<ul style="list-style-type: none"> 130 listings 3 digits for each Speed Dial field 11 characters for each name field
<ul style="list-style-type: none"> Extension Directory 	<ul style="list-style-type: none"> 40 digits for each number field 1 listing for every extension in the system 7 characters for each name field 4 digits for each extension field
<ul style="list-style-type: none"> Personal Directory 	<ul style="list-style-type: none"> 50 listings for each Personal Directory 48 MLX-20L users 11 characters for each name field 28 digits for each number field

Description

The Directory feature is a built-in, interactive telephone book that stores listings of names and telephone or extension numbers. People with MLX display telephones can dial numbers by selecting listings from the display.

Directory listings are divided into three types:

- **System Directory.** Names and numbers of outside contacts (such as clients and suppliers). These listings are created in system programming and are assigned System Speed Dial codes to allow users with telephones other than MLX display telephones to dial these listings in the directory. See [“Speed Dial” on page 648](#) for details.
- **Extension Directory (MLX display telephones only).** System extensions and the names of the users assigned to them. This directory can be accessed only with a name. Names are added to the directory by using the Labeling feature of system programming.
- **Personal Directory (MLX-20L telephones only).** Individual users' listings of names and numbers, that is, outside telephone numbers and extensions. This directory is accessible only at the extension where it was created or through system programming.

**NOTE:**

The Directory feature is not supported in ETR and MLS telephones.

System Directory

System Directory listings are established and changed only through system programming by using the Labeling feature. Each listing consists of a 3-digit Speed Dial number, an 11-character name field, and a 40-digit number field. Up to 130 listings are stored. Any listing can be specifically designated to suppress the display of a confidential number. When dialing a number designated or *marked* in this way, users see only the System Speed Dial code associated with the listing. A marked System Speed Dial code can be identified in the System Directory Report by an asterisk preceding the telephone number.

When a marked System Speed Dial code is used to dial a number, any calling restrictions associated with that number (such as outward or toll restrictions) are overridden. Marked System Speed Dial does not override ARS restrictions.

Special characters may be needed during programming of System Speed Dial codes. Each of these characters counts as one of the 40 digits allowed in the telephone number. For information about special characters and their meanings, see [Appendix H, “Programming Special Characters.”](#)

Access the System Directory by lifting the handset or pressing the Speaker button, pressing the Feature button, and dialing a 3-digit System Speed Dial code. If the System Speed Dial code is associated with a telephone number that begins with a dial-out code (usually 9), you must use an SA or ICOM button. If the associated telephone number does not begin with a dial-out code, you must use an outside line button.

Extension Directory

Extension Directory listings are established and changed only through system programming, using the Labeling feature. Each listing consists of a 7-character name field and a number field of up to four digits. There can be one listing for every extension on the system. All of the extensions in the system can be stored.

While the extension is being dialed, the display of the extension number cannot be suppressed.

Personal Directory

Personal Directory listings can be established and changed through system programming (using the Labeling feature) or by an MLX-20L user. Each listing consists of an 11-character name field and a 28-digit number field. Up to 50 listings can be included in each Personal Directory; up to 48 users of MLX-20L telephones can have Personal Directories.

For purposes of privacy or security, any listing can be *marked* to suppress the display of the telephone number during dialing. The tag, however, does not prevent the telephone number from being displayed when an MLX-20L telephone user selects `Show Number` to display the telephone number associated with an individual listing.

Special characters may be needed during programming of Personal Directory entries. Each of these characters counts as one of the 28 digits allowed. For information about special characters and their meanings, see [Appendix H, "Programming Special Characters."](#)

A listing cannot be used if the first character of the listing is a punctuation character such as a hyphen.

Any MLX-20L telephone user, except a QCC operator, can display up to 16 Personal Directory listings on the two-page Home screen. Frequently used features, not Personal Directory listings, are displayed on a QCC operator's Home screen. A QCC operator can access the Personal Directory by selecting `Directory` on the Home screen.

Extension numbers can be programmed in a Personal Directory. However, in Key and Behind Switch modes, an ICOM button must be pressed before selecting a listing to dial.

Considerations and Constraints

While a Personal Directory on an MLX-20L telephone is being programmed, calls cannot be received; the caller hears a busy signal.

Personal Speed Dial is not related to the Personal Directory. See [“Speed Dial” on page 648](#) for additional information about Personal Speed Dial.

In Release 2.1 and later systems, when an MLX telephone other than an MLX-20L is plugged into a port that has a Personal Directory resource allocated, and the Personal Directory does not contain any entries, the Personal Directory resource is released and can be programmed to be used by another user. (Up to 48 Personal Directories can exist on a system.)

Telephone Differences

Direct-Line Consoles

An operator with a digital Direct-Line Console can use all Directory features.

Queued Call Consoles

To dial extensions or telephone numbers with the touch of a button, Directory features must be used. QCC operators cannot use Auto Dial.

A QCC operator can access the Personal Directory by selecting `Directory` on the Home screen. A QCC operator can place only 12 entries in the Personal Directory: six on the first page and six more on the second page of entries.

Directory features can be used for transferring calls. If an operator releases the call immediately after pressing the button for the listing, the caller hears the dial tone plus the touch tones for the dialed digits. If the operator waits until after dialing begins, the caller does not hear the dial tone and dialed digits.

Other Multiline Telephones

Analog Multiline, ETR, MLS, MLX-10, or MLX-5 Telephones

If you have an analog multiline telephone, ETR, MLS, MLX-10, or MLX-5 telephone, you cannot use the Extension Directory feature, or the Personal Directory feature, but you can dial the listings in the System Directory by dialing the System Speed Dial codes assigned to them.

MLX-20L Telephones

While a Personal Directory on an MLX-20L telephone is being programmed, you cannot receive calls (the caller hears a busy signal), but you still can hear the telephone ringing. In Release 1.0 systems, ringing is normal. In Release 1.1 and later systems, ringing occurs at 20-second intervals.

To use the System or Extension Directory feature on an MLX-20L telephone, press the Menu button, select `Directory` from the display, and select either type of directory from the display. Next, choose a range of letters from which to begin the search. The display shows the first seven listings that begin with the first letter in the range.

To scroll through the listings, select either `Next Page` to display the next seven entries or `Prev Page` to display the previous seven entries. To display the telephone number associated with an individual listing, select `Show Number` from the display—`Show Number` is highlighted—and press the button next to the listing. To exit the `Show Number` function, select `Show Number` again—the highlight is removed from `Show Number`. To dial a number for a listing shown on the display, press the button next to the listing.

To use the Personal Directory on an MLX-20L telephone, press the Home button; a QCC operator selects `Directory` from the Home screen. If listings have been programmed to appear on the Home screen, the first eight listings (six listings for a QCC operator) are shown. To see the second eight listings (six listings for a QCC operator), select `Next Page`. To select listings by using a range of letters, select `Next Page` from the Home display *twice*. Use the same procedure to search for listings as you do for System and Extension Directories. To dial a number for a listing shown on the display, press the button next to the listing.

NOTES:

- The number for a marked Personal Directory listing is displayed when you choose `Show Number`. A marked Personal Directory listing is specifically designated during programming to suppress the telephone number from the display when the number is dialed from the display.
- Marked System Speed Dial entries (entries that do not display) are not affected by the Second Dial Tone setting. If a marked System Speed Dial entry uses star codes and the central office does not immediately supply dial tone when a star code is entered, the appropriate number of pauses (1.5 seconds each) must be programmed after each star code in the entry.

MLX-28D, MLX-16DP, MLX-10DP, MLX-10D, and MLX 5-D Telephones

To use the System or Extension Directory, press the Menu button, select *Directory* from the display, then select either type of directory from the display. To begin searching, spell the name of the directory entry by using the dialpad. For example, to spell "Wayne," dial 92963 and select *Enter* from the display; the name with the closest match is displayed.

Scroll through the listings by selecting *Prev* (previous listing) or *Next* (next listing). To start a new search, select *New*. To dial the number for the name currently shown on the display, select *Dial*, and the number is automatically dialed. If the display of the telephone number has not been suppressed, > appears on the far right of the display. To see the number, press the *More* button.

Single-Line Telephones

Single-line telephone users cannot use the Extension Directory feature or the Personal Directory feature, but can dial the listings in the System Directory by dialing the System Speed Dial codes assigned to the listings.

Feature Interactions

Account Code Entry	With an MLX-20L telephone, you can program an account code as a listing in a Personal Directory. Enter the account code from the display by activating Account Code Entry and selecting the directory entry containing the actual account code.
Allowed/Disallowed Lists	<p>If you have an outward- or toll-restricted extension, you cannot dial an outside number by using a Personal Directory or System Directory listing (excluding a marked System Directory listing), unless the number is on an Allowed List assigned to the extension.</p> <p>If a number is on a Disallowed List for an extension, you can dial it only by using a marked System Directory listing, not a regular Personal Directory or System Directory listing.</p>
Automatic Route Selection	In Hybrid/PBX mode, System Directory and Personal Directory numbers can include the ARS dial-out code.
Calling Restrictions	Using a marked System Directory listing to dial a number overrides any toll or outward calling restrictions assigned to the extension.
Conference	The Extension, Personal, and System Directory features can set up conference calls. Press the <i>Conf</i> button to enter the Flash special character in a Directory listing telephone number.
CTI Link	Through system programming, you can change the label of an extension programmed as a CTI link (Release 5.0 and later systems). If you change the system language, the label remains in the language assigned during the initial system programming.

Digital Data Calls	Digital communications devices and videoconferencing systems cannot make use of Extension, Personal, or System Directories.
Display	With an MLX display telephone, you can use the Extension and System Directories. Search for stored listings on the display and automatically dial the listing by pressing the corresponding button. With the MLX-20L telephone, you also can create a Personal Directory. When dialing a number using a Directory feature, the digits dialed are shown on Line 1 of the display.
Drop	Press the Drop button to enter the Stop special character in a directory listing telephone number.
Hold	Press the Hold button to enter the Pause special character in a directory listing telephone number.
Labeling	Use Labeling to enter names of people, groups, and locations associated with the extensions in the system and stored as listings in the Extension Directory. You can also enter labels, such as the name of a person or a business, associated with System Speed Dial numbers by using the Labeling feature, and they are stored as listings in the System Directory.
Last Number Dial	Last Number Dial does not store a number dialed by using a Directory.
Messaging	When you use the Extension Directory to call a co-worker with a posted message, the posted message is not displayed on the caller's telephone.
Personal Lines	You can use a System or Personal Directory to dial numbers on a personal line. An Extension Directory is used only for inside calls and cannot be used to dial calls on a personal line.
Pools	When a pool dial-out code is included in the telephone number for a Personal or System Directory listing, a Pause character may be needed following the pool dial-out code, depending on the local telephone company. Pause characters are entered by pressing the Hold button.
Recall/Timed Flash	Press the Conf button to enter the Flash special character in a Directory listing telephone number.
Saved Number Dial	Saved Number Dial does not store numbers dialed by using a Directory.
Second Dial Tone Timer	Marked System Speed Dial entries, which do not display, are not affected by the Second Dial Tone setting. If the central office does not immediately supply dial tone when a star code is entered and a marked System Speed Dial entry uses star codes, the appropriate number of pauses (each 1.5 seconds) must be programmed after each star code in the entry.

Speed Dial

System Speed Dial numbers are stored in the System Directory. MLX display telephone users can dial one by selecting the name from the display. If the number is on a marked System Directory listing, select the listing; you can dial it despite any calling restrictions (toll or outward) assigned to your extension.

UDP Features

In Release 6.0 and later systems (Hybrid/PBX mode only), non-local extensions cannot be included in a local Extension Directory. non-local extensions can be included in Personal and System Directories.

You cannot use a non-local system's System Directory to make calls.

Display

At a Glance

Users Affected	Telephone users, operators
Modes	All
Telephones	MLX display telephones, ETR display telephones, MLS display telephones, MERLIN II System Display Console, BIS-22D, BIS-34D
System Programming	See “Labeling” on page 413 and “Uniform Dial Plan Features” on page 741 .

Description

The following display telephones can be connected to the system:

- MLX display telephones:
 - MLX-20L (7-line by 24-character display)
 - MLX-28D (2-line by 24-character display)
 - MLX-16DP (2-line by 24-character display)
 - MLX-10D (2-line by 24-character display)
 - MLX-5D (2-line by 24-character display)
- ETR display telephones:
 - ETR-18D (2-line by 24-character display)
 - ETR-34D (2-line by 24-character display)
- MLS display telephones:
 - MLS-12D (2-line by 16-character display)
 - MLS-18D (2-line by 16-character display)
 - MLS-34D (2-line by 16-character display)
- Analog multiline display telephones:
 - MERLIN II System Display Console (2-line by 40-character display)
 - BIS-34D (1-line by 16-character display)
 - BIS-22D (1-line by 16-character display)

The telephone display provides prompts, messages, and menu selections that help users handle calls, use features, and program their extensions. In addition, the display of the MLX-20L telephone supports system programming when the

telephone is used as the system programming console. (For information about system programming displays, see [“Programming” on page 557.](#))

Beginning with Release 3.0, when a number is displayed for an incoming call, it appears with hyphens inserted between the digits (for example, 555-1234 for a 7-digit number and 908-555-1234 for a 10-digit number). Any other number of digits appears without hyphens.

The level of support the display provides depends on the telephone:

- Line 1 of the MLX and ETR telephone displays are the same; Line 1 of the analog multiline and MLS telephone displays are the same. Line 2 of an MLX telephone shows feedback, menus, softkey labels, and date and time. On ETR and MLS telephones Line 2 always shows time. Analog multiline telephones do not have a second line.
- The displays on ETR, MLS, and analog multiline telephones provide call-handling information but do not support menu-driven telephone programming or selection of features. MLS and analog multiline display telephones do not support operation in languages other than English.
- MLX display telephones provide menu-driven telephone programming and allow people to select and use features from the display. In Release 1.1 and later systems, MLX and ETR telephones (Release 7.0 and later systems) can display information in English, French, or Spanish. (The system can be programmed to provide all displays to MLX and ETR telephones in one of these languages; each MLX or ETR telephone can be programmed to operate in English, French, or Spanish, independently of the system language.)
- ETR display telephones provide Line 1 call-handling information and feature prompts similar to MLX telephones. However, ETR telephones do not support menu-driven telephone programming or the selection and use of features from the display.
- In Release 6.0 and later systems (Hybrid/PBX mode), PRI tandem trunks can provide label and extension number display at the destination MLX, ETR, or MLS display telephone. The system manager programs this capability to allow display of the label (name), extension number, or both. The following rules apply to call information displays on private networks:
 - To pass caller ID information across the private network when a call is transferred, the loop-start ID delay must be on, the Remote Call Forwarding delay must be set to one ring, and the call transfer must be completed before the call is forwarded.
 - Local calling group labels do not display at remote destination extensions. Private network calls display at the remote extension as if the remote calling group received an outside call.

- If an incoming PRI call with ANI is routed over PRI tandem trunks, the trunk label and the calling party's number appear on the MLX, ETR, or MLS display telephone at the extension where the call arrives.
- Analog or T1-emulated tandem tie trunks do not support the displaying of the label and extension number. Calls between networked systems on tie trunks display as outside calls do.
- Display operation for transfers is generally not supported across a private network. When a call is transferred and travels over PRI tandem trunks, the display shows the transferring extension.
- The system supports the display of 5-digit DEFINITY ECS or DEFINITY ProLogix Solutions extension labels, although long DEFINITY ECS or DEFINITY ProLogix Solutions labels may be truncated on MERLIN LEGEND Communications System MLX or ETR displays, which support a maximum of 7 characters for name labels.

⇒ NOTE:
 MLS and analog multiline telephone displays time out after 15 seconds.

[Table 18](#) shows examples of call-handling displays.

⇒ NOTE:
 On an ETR or MLS display telephone, the date appears on Line 1 when there is no activity.

Table 18. Call-Handling Displays

Action	Sample Displays	
	MLS/ Analog Multiline	MLX/ETR
Making Calls:		
When a user makes a call, the digits appear on the display as they are dialed with the dialpad or with any of the quick-dialing features (Auto Dial, Speed Dial, Directories, Last Number Dial, or Saved Number Dial).	1234	1234
If the caller dials an extension and labels are programmed, the name is displayed after all the digits are dialed (MLX and ETR only). ¹	12	YVONNE Ext 12

Table 18. Call-Handling Displays — Continued

Action	Sample Displays	
	MLS/ Analog Multiline	MLX/ETR
If a caller dials 0 to reach a system operator or dials the LDN (the QCC queue extension), the display identifies the number as the operator. When the call is sent immediately to a system operator without waiting in the QCC queue, the extension or label for the operator receiving the call is shown instead.	0	OPERATR 0
When a caller goes off hook on a personal line or Pool button, the display shows the label (if programmed) for the line or pool that is selected (MLX and ETR only). On MLX and ETR telephones, this information remains on the display. On analog multiline or MLS telephones, the line label is erased when the caller begins dialing. If the caller dials more than 15 digits on an MLX telephone or more than 16 digits on an analog multiline telephone, the remaining digits are shown on Line 2.	5551234	FX-NYC 5551234
For Release 6.0 and later systems (Hybrid/PBX mode only), the user sees the trunk label and the extension calling for outgoing calls to non-local dial plan.	1234	PRI-TRK 1234
Receiving Calls:		
For inside calls, the display shows the name of the caller (if labels have been programmed) and/or the extension number. On MLS and analog multiline telephones, the display also shows whether the call is a voice call (V) or a ringing call (R).	MICHEL - Ext R	MICHEL - x1234
For outside calls, the display shows the line that the call came in on.	FX-NYC	FX-NYX
If ISDN caller identification is available, the number of the caller is shown on Line 1 of an MLX, ETR, or MLS display. This information is also provided for transferred, forwarded, and calling group calls.	No display on analog multiline; 555-1234 on MLS	FX-NYX 555-1234

Table 18. Call-Handling Displays — Continued

Action	Sample Displays	
	MLS/ Analog Multiline	MLX/ETR
<p>For an incoming call from an extension in the non-local dial plan (Release 6.0 and later systems, Hybrid/PBX mode only), only calls conveyed on private PRI tandem trunks display as shown. Other non-local UDP calls display as outside calls.</p> <p>The display on MLX or ETR display telephones depends upon how the display preference is programmed:</p> <ul style="list-style-type: none"> ■ Call arriving on an extension programmed for label (Calling name) display only ■ Same call arriving on an extension programmed for extension or ANI Calling Number only ■ Same call arriving on an extension programmed for label, extension, or ANI (both) 	<p>PRI-TRK</p> <p>PRI-TRK</p> <p>PRI-TRK</p>	<p>CHARLES Ext1234</p> <p>PRI-TRK 1234</p> <p>CHARLES 1234</p>
<p>For the following incoming calls, the display also shows the type:</p> <ul style="list-style-type: none"> ■ Transfer ■ Return from Transfer ■ Coverage ■ Forwarded ■ Returning Callback ■ Group Calling 	<p>Transfer</p> <p>Receive</p> <p>Trf Ret -</p> <p>Cvr</p> <p>Forward</p> <p>Callbck</p> <p>No display</p>	<p>Transfr</p> <p>Return</p> <p>Cover</p> <p>Forward</p> <p>Callbck</p> <p>Sales Tie-Trk</p>
<p>For Release 6.0 or later systems (Hybrid/PBX mode only):</p> <ul style="list-style-type: none"> ■ Network tie trunks ■ Network PRI trunks 	<p>No display</p> <p>No display</p>	<p>Page 1:GrpCl</p> <p>Page 2:Trk 811</p> <p>Page 1:Sales 770</p> <p>Page 2:Trk 822</p> <p>101</p>

1 For calls received on tie trunks, the display shows information only if the receiver preselects the button.

Considerations and Constraints

The date and time shown on MLX telephones is controlled by the processor module in the control unit. When the date or time changes, the control unit sends the message to MLX telephones one at a time, which can cause a slight difference in the time and/or date displayed on each telephone.

Users with analog multiline telephones with displays must set the time and date at their individual telephones.

MLX Display Telephones

Four types of screens appear on both the 7-line and the 2-line displays:

- Home screen
- Menu screens
- Feature screen
- Inspect screens



NOTE:

MLX display telephones allow you to change the contrast of the screens. The method varies among the different MLX display telephones. The MLX-20L has a sliding control immediately behind the screen. The MLX 5-D, MLX-10D, MLX-10DP, MLX-16DP, and MLX-28D allow you to adjust the contrast through the `Ctrst` item in the Menu screen. Select `Ctrst` and then raise or lower the contrast by selecting Up or Down.

The display ordinarily shows the Home screen; at other times, users access the Home, Menu, Feature, and Inspect screens by pressing the corresponding fixed Home, Menu, Feature, or Inspct button.

The More button is used to read screens that include too much information to fit on the display all at once. The availability of more information is indicated by the appearance of a > character on the right side of the screen. On the 7-line by 24-character display, in Release 2.0 and later systems, this More symbol appears on Line 1, next to the More button. In Release 1.0 and 1.1 systems, the More symbol appears on Line 7.

Home Screen

The Home screen, illustrated in Figures [16](#) and [17](#), is the display's home base. It remains on the display unless the user selects another screen. If the user has programmed a posted message and no call is active on the extension, Line 1 shows the posted message. When the user makes or receives a call, Line 1 is overwritten with call-handling information, such as a number being dialed, the

name or number of a caller, and the type of incoming call. In Release 2.0 and later systems, the date is shown as pictured in Figures 16 and 17; in Release 1.0 and 1.1 systems, the date is shown as, for example, 3/15.

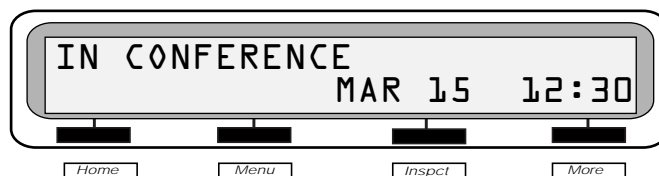

Figure 16. 2-Line Display Home Screen

When the extension is idle, Line 2 of the Home screen shows the date and time. If the timer is running or there is a programmed Alarm button, this information is also shown on Line 2.

On an MLX-20L telephone, two pages of listings from the user's Personal Directory (a total of 16 entries) can be programmed to appear on the Home screen. The Queued Call Console does not have this capability.

When a user activates features, information on the Home screen is replaced by prompts and feedback. In general, prompts appear on Line 1, and feedback appears on Line 2.

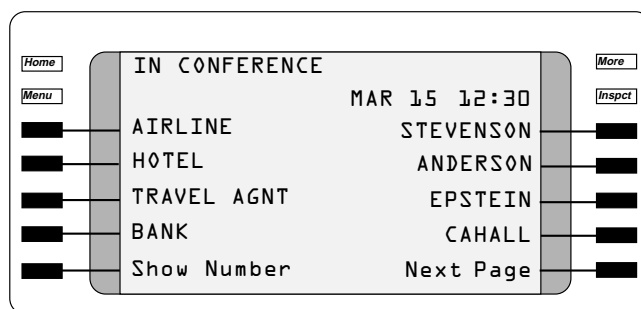

Figure 17. 7-Line Display Home Screen

Menu Screen

The Menu screen, illustrated in Figures 18 and 19, lists features and functions that are used through the display, such as Alarm Clock and Directories. For everyone with displays, except QCC operators, the Menu screen also provides access to the extension programming function used to program the extension.

Press the Menu button next to or below the display to access the Menu screen. To access additional menu choices on the 2-line display, press the More button. After you make a selection from the menu by pressing the button next to the selection on a 7-line screen or below the selection on a 2-line screen, a submenu, feature screen, or data entry screen appears. When programming is complete, the Menu screen reappears. To exit from the Menu screen, press the Home button.

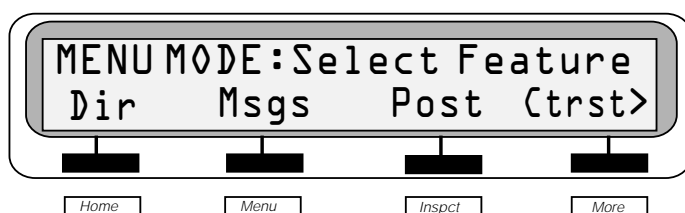

Figure 18. 2-Line Display Menu Screen

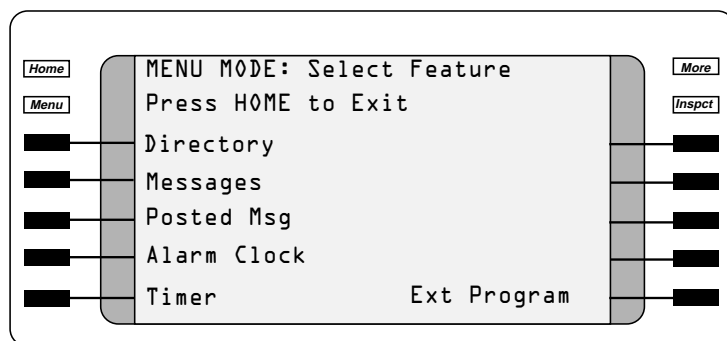

Figure 19. 7-Line Display Menu Screen



NOTE:

The Menu screen on a QCC does not include the Ext Program option.

Feature Screen

The Feature screen provides quick access to commonly used features. Press the Feature button to display one of four Feature screens with feature names. The feature names shown depend on the current activity and how the system and the extension are programmed, as shown in [Table 19](#).

To select a feature, press the button next to or below its name on the Feature screen. On a 2-line display, it may be necessary to press More to access the desired feature. Once selected, the feature is activated unless more information is required. If more information is needed, you are asked to enter it. For example, if you choose the Account Code Entry feature, the display prompts for an account code. Once account code entry is completed correctly, the Home screen returns.

[Table 19](#) lists the features that users see on the Feature screen, depending on their current calling activity.

Table 19. Feature Screen Option

Telephone	Feature Options	2-by-24 Display	7-by-24 Display
Is on hook or has a dial tone on an inside line	Last Number Dial ¹	Last#	LastNumDial
	Pickup Group ²	PkupG	Pickup Grp
	Pickup	Pkup	Pickup
	Loudspeaker Page ³	LdsPg	Loudspkr Pg
	Account Code	Acct	AccountCode
	Follow Me	FlwMe	Follow Me
	Authorization Code	Auth	Auth Code
	Direct Voice Mail	DrcVM	Direct VM
Has reached a busy extension	Selective Callback	CbckS	Cback Sel
	Barge-In ⁴	Barge	Barge In
	Leave Message	LvMsg	Leave Msg
	Camp-On ⁵	Camp	Camp On
Is ringing at an extension or connected to an inside call	Leave Message	LvMsg	Leave Msg
	Barge-In ⁴	Barge	Barge In
	Park ¹	Park	Park
	Camp-On ⁵	Camp	Camp On
	Direct Voice Mail	DrcVM	Direct VM

Table 19. Feature Screen Option — *Continued*

Telephone	Feature Options	2-by-24 Display	7-by-24 Display
Is connected to an outside line	Last Number Dial ¹	Last#	LastNumDial
	Park ¹	Park	Park
	Camp-On ⁵	Camp	Camp On
	Account Code	Acct	AccountCode
	Follow Me	FlwMe	Follow Me
	Direct Voice Mail	DrcVM	Direct VM

1 LastNumDial and Park do not appear on a QCC.

2 Pckup Grp appears on the display only if the extension is part of a Pickup Group.

3 Loudspkr Pg appears only if a loudspeaker paging system has been programmed.

4 Barge In appears only on operator consoles.

5 Camp-On can be used only to complete a transfer to an inside extension.

Inspect Screens

The Inspect screen, illustrated in Figures 20 and 21, appears when the you press the Inspct button and then press a line button. Two kinds of information can appear:

- If the button is associated with a call, calling information is displayed. If you are already on a call and another call arrives, pressing Inspct and the line button with the new call displays information about that call, without interrupting the first call.
- If the button is not associated with a call, the line or feature programmed on the button is displayed, with the exception of Last Number Dial and Saved Number Dial:
 - In Release 2.0 and later systems, inspecting a programmed Last Number Dial or Saved Number Dial button displays the number stored on the button if the button has been used; otherwise it displays the feature name.
 - In Release 1.0 and 1.1 systems, the Inspect screen shows the name of the feature on the button.

To exit from the Inspect screen, press the Home, Feature, or Menu button.



Figure 20. 2-Line Display Inspect Screen for Programmed Button

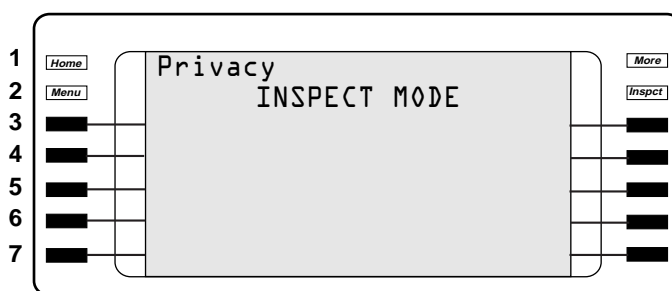

Figure 21. 7-Line Display Inspect Screen for Programmed Button

ETR Display Telephones

The following types of information appear on Line 1 of the 2-line by 24-character ETR display:

- **Call-Handling Information.** Shows telephone numbers as they are dialed, the name or number of a caller, and the type of incoming call.
- **Feature Programming Support.** Allows you to see what features have been programmed on buttons.
- **Prompts.** Prompts for information such as an account code.
- **Retrieve Message.** Allows you to retrieve messages from other telephone users and operators.

On ETR display telephones, only the first line shows call-handling, programming, or feature information. The second line shows the telephone's clock. Pressing the fixed More button on an ETR display telephone displays the second page of information.

ETR telephones do not offer menu-driven telephone programming and do not allow users to select and use features from the display.



NOTE:

In general, Line 1 of an MLS display looks like an analog multiline display, and Line 1 of an ETR display looks like an MLX display.

MLS and Analog Multiline Display Telephones

The following types of information appear on Line 1 of the 2-line by 16-character display of an MLS telephone, and on the 1-line by 16-character or 2-line by 40-character display of an analog multiline display telephone:

- **Call-Handling Information.** Shows telephone numbers as they are dialed, the name or number of a caller, and the type of incoming call.
- **Feature Programming Support.** Allows a user to see what features have been programmed on buttons.
- **Prompts and Feedback.** Prompts for information such as an account code, and provides feedback, such as confirmation of feature activation.
- **Posted Message and Leave Message.** Allow a user to see messages from other telephone users and operators.
- **Timekeeping Functions (analog multiline telephone only).** Include an alarm clock and a built-in timer, as well as the ability to set the date and time that appear on the display.

MLS and Analog multiline display telephones do not offer menu-driven telephone programming and do not allow users to select and use features from the display.

On MLS display telephones, only the first line shows call-handling, programming, or feature information. The second line shows the telephone's clock. You can program a More button on an MLS display telephone. Pressing it displays the second page of information.

The procedure for changing the contrast on the analog multiline display telephones varies among display telephones. The BIS-34D and the MERLIN II Display Console have dials to change the contrast of the screens. The BIS-22D has no controls for contrast.

Feature Interactions

Feature/Description	Sample Displays			
	MLX	ETR	MLS	Analog Multiline
<p>Account Code Entry</p> <p>When you activate the feature, the display prompts for an account code.</p> <p>As the code is dialed, it appears on the screen next to the prompt.</p>	<p>Page 1, Line 1: Acct:</p> <p>Page 1, Line 1: Acct: 123456</p>	<p>Page 1, Line 1: Acct:</p> <p>Page 1, Line 1: Acct: 123456</p> <p>If you activate Account Code while off-hook by entering the account code, the screen displays this. If you activate Account Code while on-hook by entering the account code and #, the screen displays the date on Page 1, Line 1.</p>	<p>Acct?</p> <p>Acct: 123456</p>	<p>Acct?</p> <p>Acct: 123456</p>

Feature/Description	Sample Displays			
	MLX	ETR	MLS	Analog Multiline
<p>Alarm Clock</p> <p>On an MLX telephone, you program the Alarm Clock feature from the Menu screen. On an analog multiline telephone, you set the alarm by using the timekeeping buttons next to the display. Once the alarm is set on either type of telephone, a bell appears on the display.</p> <p>On an MLX telephone, the ringer and the LEDs are turned off when <code>Alarm</code> is selected from the display. If you are on a call and select <code>Alarm</code>, the call is dropped.</p>	<p>May 08  12:00</p>	N/A	N/A	<p>ALARM: On 2:00 p</p>
<p>Authorization Codes</p> <p>When you are on a display telephone and you activate Authorization Code, the screen prompts for an entry.</p>	<p>Page 1, Line 1: Auth:</p>	<p>Page 1, Line 1: Auth: (No timeout)</p>	Auth?	Auth?
<p>Auto Dial</p> <p>When you press a programmed Auto Dial button, the digits show on the display as if you were dialing from the dialpad. The number is dialed automatically (special characters for dialing strings are described in Appendix H). If the Auto Dial number includes a Stop character, press the Auto Dial button to complete dialing.</p>	<p>Page 1, Line 1: JOHN Ext46</p>	<p>Page 1, Line 1: JOHN Ext46 (No timeout)</p>	46	46

Feature/Description	Sample Displays			
	MLX	ETR	MLS	Analog Multiline
<p>Automatic Route Selection</p> <p>Only the ARS dial-out code and the dialed number are displayed. Digits added by ARS before the dialed number and digits ignored by ARS are not displayed. The digit 9 is replaced with <code>OUTSIDE</code> when ARS selects a line.</p>	<p>Page 1, Line 1: <code>OUTSIDE</code> <code>5551234</code></p>	<p>Page 1, Line 1: <code>OUTSIDE</code> <code>5551234</code> (No timeout)</p>	<p>95551234</p>	<p>95551234</p>
<p>Barge-In</p> <p>When you are using an MLX or ETR telephone, you see a message when using Barge-In. If Barge-In is denied, no message appears.</p> <p>An MLX telephone receiving the call also receives a message indicating who barged in. The message remains on the display until the person hangs up.</p> <p>An attempt to barge in on an extension with Do Not Disturb on causes the DO NOT DISTURB message to be displayed on an MLX telephone.</p>	<p>Page 1, Line 1: <code>JOHN Ext 46</code> Page 1, Line 2: <code>Barge-In</code></p> <p>Page 1, Line 1: <code>OUTSIDE</code> <code>9571022</code> Page 1, Line 2: <code>Barge-In:</code> <code>MARIA</code></p> <p>Page 1, Line 1: <code>DO NOT DISTURB</code> Page 1, Line 2: <code>JOHN Ext 46</code></p>	<p>Page 1, Line 1: <code>JOHN Ext 46</code> (No timeout)</p> <p>Page 1, Line 1: <code>OUTSIDE</code> <code>9571022</code> (No timeout)</p> <p>Page 1, Line 1: <code>JOHN Ext 46</code></p>	<p>No display change</p> <p>No display change</p> <p>No display change</p>	<p>No display change</p> <p>No display change</p> <p>No display change</p>

Feature/Description	Sample Displays			
	MLX	ETR	MLS	Analog Multiline
<p>Callback</p> <p>When you queue a call by using Automatic Callback on an MLX, ETR, MLS, or analog multiline telephone, or by using Selective Callback on an analog multiline telephone, a feedback message appears.</p> <p>If the busy extension becomes available before the caller hangs up, a message appears.</p> <p>When the queued call rings at your extension, the display indicates that the call is a returning Callback call.</p> <p>When the caller answers the callback call, a message appears.</p> <p>When you queue a call at a busy pool, a feedback message appears.</p>	<p>Page 1, Line 1: Queued MARIA 1234 Page 1, Line 2: Call is Queued</p> <p>Page 1, Line 1: JOHN Ext 26</p> <p>Page 1, Line1: Cback JOHN Ext 26</p> <p>Page 1, Line 1: JOHN Ext 26</p> <p>Page1, Line 1: QUEUED 9571022 Page 1, Line 2: Call is Queued</p>	<p>Page 1, Line 1: Queued MARIA 1234 (No timeout)</p> <p>Page 1, Line 1: JOHN Ext 26 (No timeout)</p> <p>Page 1, Line1: Cback JOHN Ext 26 (If the caller does not answer, the date reappears.)</p> <p>Page 1, Line 1: JOHN Ext 26 (No timeout)</p> <p>Page1, Line 1: QUEUED 9571022 (No timeout)</p>	<p></p> <p>26</p> <p>Callbck JOHN</p> <p>26 (for 15 seconds)</p> <p>Call is Queued</p>	<p></p> <p>26</p> <p>Callbck JOHN</p> <p>26 (for 15 seconds)</p> <p>Call is Queued</p>

Feature/Description	Sample Displays			
	MLX	ETR	MLS	Analog Multiline
<p>Callback (continued)</p> <p>If the busy pool becomes available before the caller hangs up, a message appears.</p> <p>When the call queued for a pool rings at your extension, the display indicates that the call is a returning Callback call.</p> <p>When the caller answers the pool callback call, a message appears.</p>	<p>Page 1, Line1: OUTSIDE 9571022</p> <p>Page 1, Line 1: Cback 9571022</p> <p>Page1, Line1: OUTSIDE 9571022</p>	<p>Page 1, Line1: OUTSIDE 9571022</p> <p>Page 1, Line 1: Cback 9571022 (If the caller does not answer, the date reappears.)</p> <p>Page1, Line1: OUTSIDE 9571022</p>	<p>9571022</p> <p>Callbck 9571022</p> <p>9571022</p>	<p>9571022</p> <p>Callbck 9571022</p> <p>9571022</p>
<p>Calling Restrictions</p> <p>When you are a restricted telephone user and you try to dial a number that is restricted, you see a message on the display.</p>	<p>Page 1, Line 1: OUTSIDE 9571022</p> <p>Page 1, Line 2: Call Denied (get fast busy tone)</p>	<p>Page 1, Line 1: OUTSIDE 9571022 (get fast busy tone)</p>	<p>9571022</p>	<p>9571022</p>

Feature/Description	Sample Displays			
	MLX	ETR	MLS	Analog Multiline
<p>Call Waiting</p> <p>When a call is waiting, a message appears.</p>	<p>Page 1, Line 1: JOHN Ext 46 Page 1, Line 2: Call Waiting (receive waiting tone)</p>	<p>Page 1, Line 1: JOHN Ext 46 (No display change) (receive waiting tone) (No timeout)</p>	<p>No display change (receive waiting tone)</p>	<p>No display change (receive waiting tone)</p>
<p>Camp-On</p> <p>After Camp-On is activated, the user display shows a feedback message.</p>	<p>Page 1, Line 2: Camp On: OPERATR</p>	<p>No display change</p>	<p>No display change</p>	<p>No display change</p>

Feature/Description	Sample Displays			
	MLX	ETR	MLS	Analog Multiline
Conference				
As with any other call, dialed digits appear on Line 1 of the display as you set up a conference call.	Page 1, Line 1: Ext 1234	Page 1, Line 1: Ext 1234 (No timeout)	1234	1234
On MLX and ETR telephones, Line 1 shows the number of conference participants.	Page 1, Line 1: Conference: 4	Page 1, Line 1: Conference: 4 (No timeout)	No display change	No display change
If an SA button is not selected automatically, the MLX telephone user is prompted to select a line.	Page 1, Line 2: Select a Line	Blank (No timeout)	No display change	No display change
After a line is selected by the system or you, the MLX telephone display prompts you to dial the next participant.	Page 1, Line 1: OUTSIDE Page 1, Line 2: Dial, then Press Conf	Page 1, Line 1: OUTSIDE (No timeout)	No display change	No display change
The MLX display also prompts you to drop a conference participant after the Drop button is pressed and then shows the updated conference information on Line 1 and the dropped line or extension on Line 2.	Page 1, Line 1: Drop: Select Party Page 1, Line 2: Dropped: Ext 46; After party is dropped: Page 1, Line 1: Conference: 3	Page 1, Line 1: Drop: Select Party (No timeout); After party is dropped: Page 1, Line 1: Conference: 3	No display change	No display change

Feature/Description	Sample Displays			
	MLX	ETR	MLS	Analog Multiline
<p>Conference (continued)</p> <p>During the conference, the number of participants is shown on Line 1 of the display. The conference originator can view Caller ID or ISDN calling party information, if available, associated with any participant by pressing the Inspct button and the button the caller is on.</p>	<p>Page 1, Line 1: OUTSIDE 9571022 Page 2, Line 1: Trk801</p>	<p>N/A</p>	<p>N/A</p>	<p>N/A</p>
<p>Coverage</p> <p>When a call is sent to coverage, the person who answers the call sees a message on the display, indicating for whom the call is intended and the reason why the call is being sent to coverage.</p> <p>No Answer</p>	<p>Page 1, Line 1: Cover JUAN No Ans Page 2, Line 1: Caller: Ext 774</p>	<p>Page 1, Line 1: Cover JUAN No Ans Page 2, Line 1: Caller: Ext 774 (No timeout)</p>	<p>Cov NoA-JUAN Pre-select inside call shows blank; Pre-select outside call shows blank</p>	<p>Cov NoA-JUAN Pre-select inside call: no display change; Pre-select outside call OUTSIDE</p>
<p>Busy</p>	<p>Page 1, Line 1: Cover JUAN Busy Page 2, Line 1: Caller: Ext 774</p>	<p>Page 1, Line 1: Cover JUAN Busy Page 2, Line 1: Caller: Ext 774 (No timeout)</p>	<p>Cov Bsy-JUAN</p>	<p>Cov Bsy-JUAN</p>

Feature/Description	Sample Displays			
	MLX	ETR	MLS	Analog Multiline
<p>Coverage (continued)</p> <p>Do Not Disturb on</p>	<p>Page 1, Line 1: Cover JUAN DND Page 2, Line 1: Caller: Ext 774</p>	<p>Page 1, Line 1: Cover JUAN DND Page 2, Line 1: Caller: Ext 774 (No timeout)</p>	<p>Cov DND-JUAN</p>	<p>Cov DND-JUAN</p>
<p>Date and Time</p> <p>On an ETR, MLS, or analog multiline telephone, you can set the date and time on the display. On MLX telephones, the system controls the date and time.</p>	<p>Page 1, Line 2: Apr 01 3:00</p>	<p>Page 1, Line 1: Date Page 1, Line 2: 1:15pm</p>	<p>Page 1, Line 1: Date Page 1, Line 2: 1:15p</p>	<p>3:00p We 4-01</p>
<p>Directories</p> <p>When you dial a number from a directory, the dialed digits appear on Line 1 of the display, unless the number is marked. (ETR and MLS telephones do not support Directories.)</p>	<p>Page 1, Line 1: 9571022</p>	<p>N/A</p>	<p>N/A</p>	<p>N/A</p>
<p>Direct Station Selector</p> <p>When you press the Inspct the button and then the Page button, the message indicates the page number and the first extension number in the range.</p>	<p>Page 1, Line 1: Page 1:100</p>	<p>N/A</p>	<p>N/A</p>	<p>N/A</p>

Feature/Description	Sample Displays			
	MLX	ETR	MLS	Analog Multiline
<p>Do Not Disturb</p> <p>When a user with coverage turns on Do Not Disturb, the receiver who answers sees a message showing that the call is redirected because the sender has Do Not Disturb on.</p> <p>An MLX display telephone with Do Not Disturb on shows a Do Not Disturb message on the Home screen.</p> <p>In Release 2.0 and later, an inside caller to an MLX extension with Do Not Disturb on and no cover to voice mail sees DO NOT DISTURB.</p> <p>A caller to an ETR, MLS, or analog multiline telephone sees the extension called only.</p>	<p>Page 1, Line 1: Cover RUBEN DND</p> <p>Page 2, Line 1: Caller: Ext 46</p> <p>Page 1, Line 1: DO NOT DISTURB</p> <p>Page 1, Line 1: JOHN Ext 26</p> <p>Page 1, Line 2: DO NOT DISTURB</p>	<p>Page 1, Line 1: Cover RUBEN DND</p> <p>Page 2, Line 1: Caller: Ext 46 (No timeout)</p> <p>No display change</p> <p>Page 1, Line 1: JOHN Ext 26 (No timeout)</p> <p>JOHN Ext 26</p>	<p>COV DND-RUBEN</p> <p>No display change</p> <p>DO NOT DISTURB</p> <p>JOHN Ext 26</p>	<p>COV DND-RUBEN</p> <p>No display change</p> <p>DO NOT DISTURB</p> <p>JOHN Ext 26</p>

Feature/Description	Sample Displays			
	MLX	ETR	MLS	Analog Multiline
<p>Extension Status</p> <p>When the room has been selected and the supervisor has selected ES0, ES1, or ES2, confirmation is displayed.</p> <p>ES0 = Occupied</p> <p>ES1 = Checked Out</p> <p>ES2 = Available</p> <p>When a supervisor changes an agent's ES status, the supervisor is prompted to select the agent.</p> <p>When the agent has been selected, a confirmation appears.</p>	<p>Page 1, Line 2: Occupied</p> <p>Page 1, Line 2: Checked out</p> <p>Page 1, Line 2: Available</p> <p>Page 1, Line 1: Select Agent to Log In</p> <p>Page 1, Line 2: After call work Available Unavailable</p>	<p>N/A</p> <p>N/A</p> <p>N/A</p>	<p>N/A</p> <p>N/A</p> <p>N/A</p>	<p>N/A</p> <p>N/A</p> <p>N/A</p>
<p>Fax Extension</p> <p>On MLX and ETR display telephones, fax messages are identified as FAX. On analog multiline telephones, fax messages are indicated by Call and the extension or caller's name.</p>	<p>Page 1, Line1: *FAX Ext 12 11:15A</p> <p>Page 2, Line 1: 07/29 Ext 17</p>	<p>Page 1, Line1: *FAX Ext 12 11:15A</p> <p>Page 2, Line 1: 07/29 Ext 17</p>	<p>Page 1: *Call 17[F]></p> <p>Page 2: <11:20 AM 07/ 29</p>	<p>Page 1: *Call 17[F]></p> <p>Page 2: <11:20 AM 07/ 29</p>

Feature/Description	Sample Displays			
	MLX	ETR	MLS	Analog Multiline
<p>Follow Me</p> <p>When Follow Me is turned on or off, MLX telephone users see a prompt, then a confirmation. ETR telephone users see only the prompt (the first line). MLS and analog multiline telephone users see a code number.</p> <p>When an extension receives a Follow Me call, a message appears.</p>	<p>Page 1, Line 1: Follow from: Page 1, Line 2: Signed IN: Ext 16</p> <p>Page 1, Line 1: Forward from Ext 116 Page 2, line 1: Caller: OPERATR Ext 106</p>	<p>Page 1, Line 1: Follow from: (No timeout); after extension is entered, the date appears.</p> <p>Page 1, Line 1: Forward from Ext 116 Page 2, line 1: Caller: OPERATR Ext 106 (No timeout)</p>	<p>F34</p> <p>Forwd - OPERATR Pre-select: No display change</p>	<p>34</p> <p>Forwd - OPERATR Pre-select: No display change</p>
<p>Forward</p> <p>When you use an MLX or ETR telephone and you turn on Forward, the display prompts you for the extension. After entering the extension, a confirmation appears (MLX only).</p> <p>A user receiving a forwarded call sees a message indicating who forwarded the call</p>	<p>Page 1, Line 1: Forward to: Page 1, Line 2: Forward to: Ext 26</p> <p>Page 1, Line 1: Forward from Ext 116> Page 2, Line 1: Caller: OPERATR Ext 106></p>	<p>Page 1, Line 1: Forward to: After digits are entered, the date reappears.</p> <p>Page 1, Line 1: Forward from Ext 116> Page 2, Line 1: Caller: OPERATR Ext 106> (No timeout)</p>	<p>No display change</p> <p>Forwd-116</p>	<p>No display change</p> <p>Forwd-116</p>

Feature/Description	Sample Displays			
	MLX	ETR	MLS	Analog Multiline
<p>Forward (continued)</p> <p>Forward an outside call</p>	<p>Page 1, Line 1: Forward from OPERATR></p> <p>Page 2, Line 1: Caller; OUTSIDE Trk 801></p>	<p>Page 1, Line 1: Forward from OPERATR></p> <p>Page 2, Line 1: Caller; OUTSIDE Trk 801> (No timeout)</p>	<p>Forwd- OPERATR Pre-select shows: OUTSIDE</p>	<p>Forwd- OPERATR Pre-select shows: OUTSIDE</p>
<p>Group Calling</p> <p>When logging into the Available state, a calling group agent with an MLX telephone sees feedback messages on the display.</p> <p>When a calling group supervisor with an MLX telephone logs an agent in or out, a message appears on the supervisor's display and on the group member's display.</p> <p>After pressing either the Available or Unavailable button or dialing the feature codes, a supervisor with an MLX telephone is prompted to indicate which group member to log in or out.</p> <p>When a user dials a calling group (Ext. 770), the MLX or ETR telephone of a calling group member displays a message.</p>	<p>Page 1, Line 2: Available</p> <p>Page 1, Line 2: Available Unavailable</p> <p>Page 1, Line 1: Select Agent to Log In Select Agent to Log Out</p> <p>Page 1, Line 1: GrpCl OPERATR Ext 10</p>	<p>Page 1, Line 1: Date</p> <p>No display change on agent's telephone</p> <p>N/A</p> <p>Page 1, Line 1: GrpCl OPERATR Ext 10</p>	<p>N/A</p> <p>N/A</p> <p>N/A</p> <p>No display change; pre- select: no display change</p>	<p>No display change</p> <p>No display change</p> <p>No display change</p> <p>No display change; pre- select: no display change</p>

Feature/Description	Sample Displays			
	MLX	ETR	MLS	Analog Multiline
<p>Group Calling (continued)</p> <p>When a group member with an MLX or ETR telephone receives an outside call for the group, the type of call appears on the display with the label for the line on which the call came in.</p>	<p>Page 1, Line 1: SALES OUTSIDE Page 2, Line 1: Trk805</p>	<p>Page 1, Line 1: SALES OUTSIDE Page 2, Line 1: Trk805 (No timeout)</p>	<p>No display change; pre-select shows OUTSIDE</p>	<p>No display change; pre-select shows OUTSIDE</p>
<p>Hold</p> <p>When an MLX telephone user or an MLX DLC operator places a call on hold, a confirmation is displayed.</p> <p>When an MLX telephone user or an MLX DLC operator has a call on hold for a longer time than the hold timer value, a message appears on the display. (A beep sounds on all multiline telephones.)</p>	<p>Page 1, Line 2: Call on Hold</p> <p>Page 1, Line 2: Call on Hold (audible beep)</p>	<p>Page 1, Line 1: Date</p> <p>No display change (audible beep)</p>	<p>No display change</p> <p>No display change (audible beep)</p>	<p>No display change</p> <p>No display change (audible beep)</p>
<p>Select call on Hold</p>	<p>No display change</p>	<p>No display change</p>	<p>No display change for inside call; OUTSIDE for outside call</p>	<p>No display change for inside call; OUTSIDE for outside call</p>
<p>Answer inside Hold call</p>	<p>Page 1, Line 1: JOHN Ext 200</p>	<p>Page 1, Line 1: JOHN Ext 200</p>	<p>No display change</p>	<p>No display change</p>
<p>Answer outside Hold call</p>	<p>Page 1, Line 1: OUTSIDE Page 2, Line 1: Trk 801</p>	<p>Page 1, Line 1: OUTSIDE Page 2, Line 1: Trk 801 (No timeout)</p>	<p>No display change</p>	<p>No display change</p>

Feature/Description	Sample Displays			
	MLX	ETR	MLS	Analog Multiline
<p>Inspect</p> <p>With an MLX telephone, you can inspect the contents of programmed buttons by pressing the Inspct button and then the programmed button. In most cases, the display shows the feature or line assigned to the button. (In Release 2.0 and later systems, inspecting a Last Number Dial or Saved Number Dial button shows the number stored on the button.)</p> <p>You can also inspect incoming calls or your calls on hold.</p> <p>If you inspect a line that someone else is using, the display shows that the line is in use.</p>	<p>Page 1, Line 1: Account Code</p> <p>Page 1, Line 1: OUTSIDE 9571022</p> <p>Page 2, Line 1: Trk 801</p> <p>Page 1, Line 1: In Use</p>	<p>N/A</p> <p>N/A</p> <p>N/A</p>	<p>N/A</p> <p>N/A</p> <p>N/A</p>	<p>N/A</p> <p>N/A</p> <p>N/A</p>
<p>Last Number Dial</p> <p>When you press a programmed Last Number Dial button, you see digits on the display as if dialing them from the dialpad.</p> <p>In Release 2.0 and later systems, inspecting a Last Number Dial button shows the stored number.</p>	<p>Page 1, Line 1: OUTSIDE 9571022</p> <p>or</p> <p>JOHN Ext 26</p>	<p>Page 1, Line 1: OUTSIDE 9571022</p> <p>or</p> <p>JOHN Ext 26 (No timeout)</p>	<p>99571022 or 26</p>	<p>99571022 or 26</p>

Feature/Description	Sample Displays			
	MLX	ETR	MLS	Analog Multiline
Messaging				
When you send a message to another telephone, a feedback message appears.	Page 1, Line 2: Msg. Sent to: CARL	No display change	Msg Sent CARL	Msg Sent CARL
When you try to retrieve messages and the message box is empty, the display indicates that there are no messages.	Page 1, Line 1: No Messages	Page 1, Line 1: No Messages (No timeout)	No Messages	No Messages
When you have a message, the display shows the name or extension of the caller and, on MLX and ETR telephones, the time and date the message was left. Messages can be sent from inside extensions, by an operator, by a fax machine, or, if the extension has voice mail, by outside callers. An unread message is marked with an asterisk (*).	Page 1, Line 1: * JOSE Ext 26 10:43p Page 2, Line 1: 04/30 Ext 26	Page 1, Line 1: * JOSE Ext 26 10:43p Page 2, Line 1: 04/30 Ext 26 (No timeout)	Page 1: *Call 17[x] Page 2: <12:43 AM 01/ 03	Page 1: *Call 17[x] Page 2: <12:43 AM 01/ 03
When you call an extension with a posted message, you see a message on your display telephone.	Page 1, Line 1: JOHN Ext 101 Page 1, Line 2: IN A MEETING	Page 1, Line 1: JOHN Ext 101	IN A MEETING	IN A MEETING
When you post a message from an MLX display telephone, you see the message displayed on the Home screen.	Page 1, Line 1: AT HOME	Page 1, Line 1: Date	No display change	No display change
When an operator using an MLX telephone sends or removes a message with the Send/Remove message feature, the operator is prompted for the number.	Page 1, Line 1: Dial Phone Number	N/A	N/A	N/A

Feature/Description	Sample Displays			
	MLX	ETR	MLS	Analog Multiline
<p>Night Service (continued)</p> <p>When a DID call comes in to a Night Service group, a message appears.</p>	<p>Page 1, line 1: OUTSIDE Page 2, Line 1: Trk 801</p>	<p>Page 1, line 1: OUTSIDE Page 2, Line 1: Trk 801 (No timeout)</p>	<p>OUTSIDE; Pre-select shows OUTSIDE</p>	<p>OUTSIDE; Pre-select shows OUTSIDE</p>
<p>Paging</p> <p>When you use Group Paging, you see a message showing the number of the paging group.</p>	<p>Page 1, Line 1: 793 Page 1, Line 2: Paging 793</p>	<p>Page 1, Line 1: 793</p>	<p>793</p>	<p>793</p>
<p>Park</p> <p>When a call is parked, a confirmation is displayed.</p> <p>When the call has been parked a long time, a message appears on an MLX telephone, and a beep sounds on all multiline telephones.</p>	<p>Page 1, Line 2: Parked: ANNA Page 1, Line 2: Call on Hold (beep)</p>	<p>No display change No display change (beep)</p>	<p>Parked: ANNA No display change (beep)</p>	<p>Parked: ANNA No display change (beep)</p>
<p>Personal Lines</p> <p>When a BRI call comes in, a message appears.</p>	<p>Page 1, Line 1: BRI-TRK 732- 615-9210 Page 2, Line 1: Trk805 615- 0736</p>	<p>Page 1, Line 1: BRI-TRK 732- 615-9210 Page 2, Line 1: Trk805 615- 0736 (No timeout)</p>	<p>No display change. Pre- or post-select shows 732-615- 9210</p>	<p>No display change. Pre- or post-select shows OUTSIDE</p>

Feature/Description	Sample Displays			
	MLX	ETR	MLS	Analog Multiline
<p>Personal Lines (continued)</p> <p>When a Caller ID call comes in, a message appears.</p>	<p>Page 1, Line 1: OUTSIDE 732-957-9684 or Calling Party Name Page 2, Line 1: Trk801</p>	<p>Page 1, Line 1: OUTSIDE 732-957-9684 or Calling Party Name Page 2, Line 1: Trk801 (No timeout)</p>	<p>No display change. Pre- or post-select shows 732-957-9604 or Calling Party Name.</p>	<p>No display change. Pre- or post-select shows Trk 801.</p>
<p>Pickup</p> <p>When you activate Pickup on an MLX or ETR telephone, a prompt appears on the display. (The prompt is not displayed if a button programmed for a specific line or extension is used.)</p> <p>After you enter the line or extension number to pick up the call, a confirmation message is displayed.</p>	<p>Page 1, Line 1: Pickup Line/ Ext: Page 1, Line 1: OUTSIDE Page 1, Line 2: Pickup: OUTSIDE or Page 1, Line 2: Pickup: JOHN Ext 17</p>	<p>Page 1, Line 1: Pickup Line/ Ext: (No timeout) Page 1, Line 1: OUTSIDE (No timeout)</p>	<p>No display change 3801 (line number) or 26 (extension number)</p>	<p>No display change 3801 (line number) or 26 (extension number)</p>

Feature/Description	Sample Displays			
	MLX	ETR	MLS	Analog Multiline
<p>Pools</p> <p>When you select a Pool button on a display telephone and lift the handset, the display shows the lines in the selected pool.</p> <p>When you receive a call on a pool button, a message appears.</p>	<p>Page 1, Line 1: OUTSIDE 9571022</p> <p>Page 1, Line 1: OUTSIDE Page 1, Line 2: Trk801</p>	<p>Page 1, Line 1: OUTSIDE 9571022 (No timeout)</p> <p>Page 1, Line 1: OUTSIDE (No timeout)</p>	<p>No display change</p> <p>No display change. Pre-select shows OUTSIDE</p>	<p>No display change</p> <p>No display change. Pre-select shows OUTSIDE</p>
<p>Privacy</p> <p>When you turn on or turn off Privacy on an MLX display telephone, the display briefly shows the message <i>Privacy On</i> or <i>Privacy Off</i> before returning to the Home screen or call-handling display.</p>	<p>Page 1, Line 2: <i>Privacy On</i> or <i>Privacy Off</i></p>	<p>No display change</p>	<p>No display change</p>	<p>No display change</p>
<p>Recall/Timed Flash</p> <p>On an MLX or ETR telephone, when you press a programmed Recall button while on an outside line, the line information is redisplayed just as if you had gone off-hook on the line.</p>	<p>Page 1, Line 1: OUTSIDE</p>	<p>Page 1, Line 1: OUTSIDE</p>	<p>No display change</p>	<p>No display change</p>

Feature/Description	Sample Displays			
	MLX	ETR	MLS	Analog Multiline
Reminder Service				
When Reminder Set is activated, the extension number and either the set time or an indication that no time has been set is displayed.	Page 1, Line 1: Time: Page 1, Line 2: 17:No reminder Set or Page 1, Line 1: Time: Page 1, Line 2: 17:01:20PM	Page 1, Line 1: Time: (No timeout)	17: No Rmdr Set or 17: 01:20PM	17: No Rmdr Set or 17: 01:20PM
If you enter a new time, the display changes with the first digit.	Page 1, Line 1: Time: 12:30p Page 1, Line 2: 26: No reminder Set	Page 1, Line 1: Time: 12:30p	Time: 12:30p	Time?12:30p
When the time is set, a confirmation including the extension and the time is displayed.	Page 1, Line 2: 7103: 12:30p	Page 1, Line 1: Date	7103: 12:30PM	7103: 12:30PM
When a reminder call alerts an extension, the display indicates a reminder call.	Page 1, Line 1: Reminder Call	Page 1, Line 1: Reminder Call (No timeout)	Rmdr Call	Rmdr Call
When an extension cancels a reminder, a confirmation is displayed.	Page 1, Line 2: Reminder Off	No display change	Rmdr Off at 7103	Rmdr Off at 7103

Feature/Description	Sample Displays			
	MLX	ETR	MLS	Analog Multiline
<p>Reminder Service (continued)</p> <p>When an MLX operator sets or cancels a reminder for an extension, he or she is prompted for the extension.</p>	<p>Press DSS Key to Select Reminder Set</p> <p>or</p> <p>Press DSS Key to Select Reminder Off</p>	<p>No display change</p>	<p>No display change</p>	<p>No display change</p>
<p>Remote Access</p> <p>If a remote access call is sent to coverage because an invalid number is dialed, an MLX or ETR telephone user who receives the call sees a message. If Caller ID or ISDN caller information is available, pressing the More button displays the calling party number and facility label. If Caller ID or ISDN caller information is available, an MLS telephone user can see the facility label and calling party number by pre- or post-selecting the line button.</p>	<p>Page 1, Line 1: Cover DISA#?</p> <p>Page 2, Line 1: OUTSIDE Trk801</p>	<p>Page 1, Line 1: Cover DISA#?</p> <p>Page 2, Line 1: OUTSIDE Trk801 (No timeout)</p>	<p>No display change; Pre- or post-select: OUTSIDE</p>	<p>No display change; Pre- or post-select: OUTSIDE</p>

Feature/Description	Sample Displays			
	MLX	ETR	MLS	Analog Multiline
<p>Saved Number Dial</p> <p>On an MLX telephone, when you press a programmed Saved Number Dial button, a confirmation is displayed.</p> <p>When you dial a number by pressing a programmed Saved Number Dial button, the digits appear on the display as if from the dialpad.</p>	<p>Page 1, Line 1: JOHN Ext 26 or OUTSIDE 9571022 Page 1, Line 2: Number Saved</p> <p>Page 1, Line 1: JOHN Ext 26 or OUTSIDE 9571022</p>	<p>Page 1, Line 1: JOHN Ext 26 or OUTSIDE 9571022 (No timeout)</p> <p>Page 1, Line 1: JOHN Ext 26 or OUTSIDE 9571022 (No timeout)</p>	<p>No display change</p> <p>9571022</p>	<p>No display change</p> <p>9571022</p>
<p>System Access/ Intercom Buttons</p> <p>If you call an extension from a display telephone and the call is answered at a Shared SA button, your display shows the principal extension, not the answering extension.</p>	<p>Page 1, Line 1: JOHN Ext 17</p>	<p>Page 1, Line 1: JOHN Ext 17 (No timeout)</p>	<p>Ext 17 Pre-select: No display change</p>	<p>Ext 17 Pre-select: No display change</p>
<p>System Speed Dial</p> <p>When you press the programmed System Speed Dial button, the number dialed appears on the display.</p>	<p>Page 1, Line 1: OUTSIDE 9571022 or Ext 17 (inside call)</p>	<p>Page 1, Line 1: OUTSIDE 9571022 or Ext 17 (inside call) (No timeout)</p>	<p>17</p>	<p>17</p>

Feature/Description	Sample Displays			
	MLX	ETR	MLS	Analog Multiline
<p>System Speed Dial (continued)</p> <p>When you press a marked System Speed Dial button, the number dialed appears on the display.</p>	Page 1, Line 1: OUTSIDE 611	Page 1, Line 1: OUTSIDE 611 (No timeout)	611	611
<p>Timer</p> <p>MLX and analog multiline display telephones have a built-in timer that allows timing of calls or other events. On the MLX display the timer appears on Line 2 and counts to 59 minutes and 59 seconds, then resets to zero and continues counting.</p>	Page 1, Line 2: 00:20 Jul 30 10:29	N/A	N/A	12:00a 39:15
<p>Transfer</p> <p>On an MLX telephone, when you press the Transfer button, the display prompts you to dial the extension number.</p> <p>On an MLX telephone (SA Voice or ICOM Voice), if you initiate a transfer on a voice-announce button, the display prompts you to enter the extension number.</p> <p>On an MLX or ETR telephone, the display shows the digits as they are dialed. When all digits are dialed, the display shows the extension dialed.</p>	<p>Page 1, Line 2: Transfer To:</p> <p>Page 1, Line 2: Announce To:</p> <p>Page 1, Line 1: JOHN Ext 17 Page 1, Line 2: Announce To: or Transfer To:</p>	<p>Blank (Page 1, Line 1: waiting for dialing digits)</p> <p>Blank (Page 1, Line 1: waiting for dialing digits)</p> <p>Page 1, Line 1: JOHN Ext 17</p>	<p>No display change</p> <p>No display change</p> <p>17 No display change</p>	<p>No display change</p> <p>No display change</p> <p>17 No display change</p>

Feature/Description	Sample Displays			
	MLX	ETR	MLS	Analog Multiline
Transfer (continued)				
On an MLX telephone, a confirmation is displayed.	Page 1, Line 2: Call Transferred	Page 1, Line 1: Date	17 or No display change	17 or No display change
When inside calls return from transfer, the extension returning the transfer and the caller appear on MLX and ETR telephones.	Page 1, Line 1: Return: CHARL Ext 1234 Page 2, Line 1: Caller: ANNA Ext 1235	Page 1, Line 1: Return: CHARL Ext 1234 Page 2, Line 1: Caller: ANNA Ext 1235 (No timeout)	Trf Ret- CHARLES Pre-select: no display change	Trf Ret- CHARLES Pre-select: no display change
When outside calls return from transfer, the extension returning the transfer and the line/trunk used appear on MLX and ETR telephones.	Page 1, Line 1: Return: CHARL Ext 1234 Page 2, Line 1: Caller: OUTSIDE Trk801	Page 1, Line 1: Return: CHARL Ext 1234 Page 2, Line 1: Caller: OUTSIDE Trk801 (No timeout)	Trf Ret- CHARLES Pre-select: OUTSIDE	Trf Ret- CHARLES Pre-select: OUTSIDE
On an MLX or ETR telephone, if you do not complete a transfer (for example, when Do Not Disturb is on at the destination), the call returns to your telephone and call information is displayed.	Page 1, Line 1: Incomplete Transfer Page 2, Line 1: Caller: SUSAN Ext 1235	Page 1, Line 1: Incomplete Transfer Page 2, Line 1: Caller: SUSAN Ext 1235 (No timeout)	Invalid Station #	Invalid Station #

Feature/Description	Sample Displays			
	MLX	ETR	MLS	Analog Multiline
<p>Transfer (continued)</p> <p>On an MLX or ETR telephone, if you receive a transferred inside call, the transferred and the transferring extensions appear.</p> <p>On an MLX or ETR telephone, if you receive a transferred inside call, the transferred and the transferring extensions appear.</p>	<p>Page 1, Line 1: Transfr ANGELA Page 2, Line 1: Transfr by MIGUEL</p> <p>Page 1, Line 1: Transfr OUTSIDE Trk 801 Page 2, Line 1: Transfr by OPERATR</p>	<p>Page 1, Line 1: Transfr ANGELA Page 2, Line 1: Transfr by MIGUEL (No timeout)</p> <p>Page 1, Line 1: Transfr OUTSIDE Trk 801 Page 2, Line 1: Transfr by OPERATR (No timeout)</p>	<p>Transfer Receive Pre-or post- select: Transfer Receive</p> <p>Transfer Receive Pre-or post- select: OUTSIDE</p>	<p>Transfer Receive Pre-or post- select: Transfer Receive</p> <p>Transfer Receive Pre-or post- select: OUTSIDE</p>
<p>UDP Displays</p> <p>Call arriving on an extension programmed for label (calling name) display only</p>	<p>Page 1, Line 1: OPERATR Ext 5010 Page 2, Line 1: Trk8125 4010</p>	<p>Page 1, Line 1: OPERATR Ext 5010 Page 2, Line 1: Trk8125 4010 (No timeout)</p>	<p>No display change; Pre- or post-select: PRI-UDP or NAME</p>	<p>No display change; Pre- or post-select: PRI-UDP or NAME</p>

Feature/Description	Sample Displays			
	MLX	ETR	MLS	Analog Multiline
UDP Displays (continued)				
Call arriving on an extension programmed for extension or ANI calling number only	Page 1, Line 1: OUTSIDE Ext 5010 Page 2, Line 1: Trk8125 4010	Page 1, Line 1: OUTSIDE Ext 5010 Page 2, Line 1: Trk8125 4010 (No timeout)	No display change; Pre- or post-select: PRI-UDP or NAME	No display change; Pre- or post-select: PRI-UDP or NAME
Same call arriving on an extension programmed for label, extension, or ANI (both)	Page 1, Line 1: OPERATR Ext 5010 Page 2, Line 1: Trk8125 4010	Page 1, Line 1: OPERATR Ext 5010 Page 2, Line 1: Trk8125 4010 (No timeout)	No display change; Pre- or post-select: PRI-UDP or NAME	No display change; Pre- or post-select: PRI-UDP or NAME
UDP over tie lines	Page 1, Line 1: TIE-TRK Page 2, Line 1: Trk801	Page 1, Line 1: TIE-TRK Page 2, Line 1: Trk801 (No timeout)	No display change; Pre- or post-select: TIE-UDP	No display change; Pre- or post-select: TIE-UDP
Caller ID line assigned to a calling group with a non-local member 2000 over PRI private network	Page 1, Line 1: PRI-UDP 732- 957-9604 Page 2, Line 1: Trk3810 2000	Page 1, Line 1: PRI-UDP 732- 957-9604 Page 2, Line 1: Trk3810 2000 (No timeout)	No display change; Pre- or post-select: Calling party number or name	No display change; Pre- or post-select: Calling party number or name

Feature/Description	Sample Displays			
	MLX	ETR	MLS	Analog Multiline
<p>UDP Displays (continued)</p> <p>BRI line assigned to a calling group with a non-local member 2000 over PRI private network</p>	<p>Page 1, Line 1: PRI-UDP 732-957-9604 Page 2, Line 1: Trk3810 2000</p>	<p>Page 1, Line 1: PRI-UDP 732-957-9604 Page 2, Line 1: Trk3810 2000 (No timeout)</p>	<p>No display change; Pre- or post-select: PRI-UDP or NAME</p>	<p>No display change; Pre- or post-select: PRI-UDP or NAME</p>
<p>PRI dial plan routing from Dave at 732-446-1001 (ANI) to 446-1314 (Remote Access)</p>	<p>Page 1, Line 1: DAVE 732-446-1001 Page 2, Line 1: Trk2854 446-1314</p>	<p>Page 1, Line 1: DAVE 732-446-1001 Page 2, Line 1: Trk2854 446-1314 (No timeout)</p>	<p>No display change; Pre- or post-select: PRI-TRK or DAVE</p>	<p>No display change; Pre- or post-select: PRI-TRK or DAVE</p>
<p>■ <i>PRI dial pan routing over a PRI private network form DAVE at 732-446-1001 extension 2000 by dialing to 446-1320</i></p>	<p>Page 1, Line 1: DAVE 732-446-1001 Page 2, Line 1: Trk2854 2000</p>	<p>Page 1, Line 1: DAVE 732-446-1001 Page 2, Line 1: Trk2854 2000 (No timeout)</p>	<p>No display change; Pre- or post-select: PRI-TRK or DAVE</p>	<p>No display change; Pre- or post-select: PRI-TRK or DAVE</p>
<p>BRI over a PRI private network from DAVE at 732-446-1001 extension 2000 by dialing to 446-1320</p>	<p>Page 1, Line 1: PRI-UDP 732-446-1001 Page 2, Line 1: Trk2854 2000</p>	<p>Page 1, Line 1: PRI-UDP 732-446-1001 Page 2, Line 1: Trk2854 2000 (No timeout)</p>	<p>No display change; Pre- or post-select: PRI-TRK or DAVE</p>	<p>No display change; Pre- or post-select: PRI-TRK or DAVE</p>

Do Not Disturb

At a Glance

Users Affected	Telephone users, DLC operators
Reports Affected	Extension Information
Modes	All
Telephones	All except QCC and single-line telephones
Programming Code	*47
MLX Display Label	DO NOT DISTURB [DND]

Description

Do Not Disturb prevents calls from ringing and prevents paging over a speakerphone. When you turn on the feature and receive an outside call, the caller hears ringback, but your telephone does not ring. The green LED next to the line button with the ringing call flashes to indicate an incoming call, and, if you choose, you can answer the call. If the feature is turned on and you receive an inside call, the inside caller hears a busy signal. The telephone does not ring, and the green LED next to an SA or ICOM button does not flash.

The types of priority calls listed below override Do Not Disturb and cause the telephone to ring; the green LED also flashes.

- A call (including a transferred call) from any coverage receiver to a sender with Do Not Disturb on
- A Barge-In call
- A returning transferred or camped-on call, or a parked call returning to a DLC operator
- A Callback call, notifying you that a call to a busy extension or to a busy pool (Hybrid/PBX mode only) can be completed
- A Reminder call

In Release 2.0 and later systems, when a user turns on the feature, the system automatically posts the message `DO NOT DISTURB`. Users with ETR, MLS, analog multiline, MLX-10, or MLX-5 nondisplay telephones must program a Posted Message button in order to display the message for callers. This message appears on the Home screen of an MLX display telephone with Do Not Disturb turned on. `DO NOT DISTURB` also appears on the screen of any MLX, MLS, and analog multiline telephone that is used to call an extension that has the feature turned on. When you turn off Do Not Disturb, the system automatically removes

the message. You can also post and remove the message by using a programmed Posted Messages button. Using this button, however, only posts or removes the message; it does not turn on or turn off the Do Not Disturb feature.

Considerations and Constraints

Do Not Disturb must be programmed onto an available button.

If you turn on Do Not Disturb while receiving a call (ringing or voice-announced), the caller continues to hear ringback (or a voice-announced caller may stay on the line), but you do not hear ringing. The Do Not Disturb feature remains on.

When Do Not Disturb is turned on, your calls ring at other telephones with shared personal lines or at coverage receivers, but not at other telephones with Shared SA buttons.

Telephone Differences

Direct-Line Consoles

The green LED next to an Auto Dial or DSS button on a DLC turns on when a user turns on Do Not Disturb, indicating that the user is not available.

Queued Call Consoles

Do Not Disturb cannot be used on a QCC; Position Busy must be used instead. The green LED next to a DSS button turns on when a user turns on Do Not Disturb, indicating to the QCC operator that the user is not available.

Other Multiline Telephones

Activate Do Not Disturb on a multiline telephone by pressing the programmed Do Not Disturb button. The green LED next to the button goes on to indicate that the feature is active. To turn off the feature, press the programmed Do Not Disturb button again. The green LED next to the button turns off. Feature codes cannot be used to turn Do Not Disturb on and off.

In Release 2.0 and later systems, turning on Do Not Disturb on an ETR, MLS, analog multiline, MLX-10, or MLX-5 nondisplay telephone does not automatically post the Do Not Disturb message; program a Posted Messages button for the message to be posted automatically. When Do Not Disturb is turned on, the green LED next to the Posted Messages button lights automatically and the system posts DO NOT DISTURB. When Do Not Disturb is turned off, the system automatically turns off the green LED next to the Posted Messages button.



NOTE:

Do not press the Posted Messages button; the LED blinks but no message is posted.

Single-Line Telephones

Do Not Disturb is not available on single-line telephones.

Feature Interactions

Auto Dial	When you turn on Do Not Disturb, the green LEDs next to all Auto Dial buttons programmed with your extension go on.
Barge-In	Barge-In overrides Do Not Disturb.
Callback	Calls to a user with Do Not Disturb on are not eligible for callback queuing. If the callback originator is using Do Not Disturb, the system overrides the feature; the telephone rings when the busy extension or line/trunk is available.
Caller ID	Caller ID information is not displayed if the user turns on Do Not Disturb. If the user turns on Do Not Disturb while receiving Caller ID information, that information remains on the display.
Camp-On	A Camp-On call does not ring when the destination extension has Do Not Disturb turned on.
Coverage	<p>When a sender turns on Do Not Disturb, calls go to Individual and/or Group Coverage receivers. Individual and/or Group Coverage calls are not sent to a receiver with Do Not Disturb turned on. If a sender and all receivers have Do Not Disturb turned on, the call is not sent to coverage and the caller hears a busy tone.</p> <p>When a sender turns on Do Not Disturb, any receivers for that sender can call the sender.</p> <p>In Release 2.1 and later systems, calls received on personal lines with Do Not Disturb on go immediately to coverage, instead of waiting for the Coverage Delay Interval.</p>
Digital Data Calls	Digital communications devices can activate Do Not Disturb by dialing the virtual button number (for example, #01) of the Do Not Disturb button. Do Not Disturb can be activated by video systems that have the ability to dial strings and feature codes beginning with #.
Direct Station Selector	In Release 2.0 and later systems, an operator can check the status of an extension whose red LED is on by using the Inspct button to determine whether the extension is busy or using Do Not Disturb. If the user at the extension is using Do Not Disturb, the DO NOT DISTURB message is also posted and appears on the operator's display. (The message, however, may also mean that the user has posted the message without turning on the Do Not Disturb feature.)

- Display** In Release 2.0 and later systems, when a multiline telephone user with coverage turns on Do Not Disturb and calls are sent to coverage receivers, the receiver with a display sees a message when answering the call; it shows that the call has been redirected because the sender turned on Do Not Disturb.
- If an MLX, MLS, or analog multiline display telephone user tries to transfer a call to a user with Do Not Disturb active, the display shows DO NOT DISTURB.
- Forward and Follow Me** Calls are not forwarded to a destination extension that has Do Not Disturb turned on; the call rings only at the forwarding telephone as described in [Table 10 on page 244](#). Turning on Do Not Disturb at the forwarding extension does not prevent the calls from being forwarded.
- In Release 4.0 and later systems, turning on Do Not Disturb at a forwarding extension causes calls to be forwarded immediately. The Forwarding Delay has no effect.
- Group Calling** If a calling group member uses Do Not Disturb, calls are not sent to the group member even if he or she is logged in and available.
- Headset Options** If an MLX telephone user with Headset Auto Answer uses Do Not Disturb, any calls that override Do Not Disturb (such as Barge-In calls and callback calls) are automatically answered.
- Labeling** Labeling is used to enter the names of the persons or businesses associated with the System Speed Dial numbers stored as listings in the System Directory. It is also used to enter the names of people, groups, and locations associated with the extensions in the system stored as listings in the Extension Directory. Labeling is used to enter the telephone numbers and label information associated with Personal Directories on MLX-20L telephones. This information can also be programmed by the user at the extension.
- Messaging** In Release 2.0 and later systems, when Do Not Disturb is turned on, the system automatically posts DO NOT DISTURB. This message appears on the Home screen of an MLX display telephone user with Do Not Disturb turned on. DO NOT DISTURB also appears on the screen of any MLX, MLS, and analog multiline telephone that is used to call an extension that has the feature turned on. The system automatically removes the message when the user turns off the feature.
- With ETR, MLS, analog multiline, MLX-10, or MLX-5 nondisplay telephones, you must program a Posted Messages button for the system to automatically post or remove the message when the feature is turned on or off. You can remove a DO NOT DISTURB message by pressing a programmed Posted Messages button.
- Posting the DO NOT DISTURB message does not turn the feature on; removing the posted message does not turn the feature off.

Multi-Function Module	Using Do Not Disturb is not recommended because the device connected to the MFM does not have an LED to indicate when the feature is active.
Paging	Group pages cannot be made to a telephone with Do Not Disturb on.
Reminder Service	Reminder calls ring at telephones with Do Not Disturb turned on.
Service Observing	<p>In Release 6.1 and later systems a Service Observer can observe calls even if the observed extension uses the Do Not Disturb feature.</p> <p>Activating Do Not Disturb at a Service Observer extension does not block the Service Observer from being alerted when a call comes into an observed extension.</p> <p>When an extension being observed activates Do Not Disturb, this causes the green LED next to the observed extension's button on the Service Observer's telephone or the red LED on the DSS to light.</p>
Signal/Notify	Signaling cannot be used when the destination telephone user turns on Do Not Disturb.
System Access/ Intercom Buttons	Do Not Disturb prevents ringing of incoming calls at SA or ICOM buttons (including Shared SA buttons) on the telephone where the feature is turned on. This also prevents calls received on the principal's SA buttons from ringing at other telephones with Shared SA buttons for that extension.
Transfer	Calls transferred to telephones that have Do Not Disturb turned on are returned after the transfer return interval expires, unless the telephone has coverage and a receiver is available. In that case, the transferred call is sent to the receiver.
Voice Announce	A user with Do Not Disturb active does not receive voice-announced calls.

Features
Drop

316

Drop

See [“Conference”](#) on page 158.

Extension Status

At a Glance

Users Affected	DLC operators, hotel supervisors/rooms, calling group supervisors/members, Call Management System (CMS) supervisors/members
Reports Affected	Direct Group Calling Information, SMDR, System Information (SysSet-up), Extension Information
Modes	All
Telephones	DLCs, room or calling group member (agent) telephones
Programming Codes	
DLCs/Supervisors	
Status 0/Unavailable	*760
Status 1/After-call work state	*761 (hotel and CMS only)
Status 2/Available	*762
Telephones (rooms or agents)	
Status 1/After-call work state	*45 (hotel and CMS only)
Status 2/Log in or out	*44
Feature Codes	
Activate Extension Status/ Supervisory Operation	32 + Hold (calling group/CMS only)
Deactivate Extension Status	32 + Drop (calling group/CMS only)
DLC	
Status 0/Unavailable	760 + DSS button
Status 1/After-call work state	761 + DSS button (hotel and CMS only)
Status 2/Available	762 + DSS button
Telephones (rooms or agents)	
Status 0/ Unavailable	*44 (calling group/CMS only)
Status 1/ After-call work state	45 (hotel and CMS only)
Status 2/Available	44
MLX Display Labels	
Status 0/Unavailable	ES Status, ES Off [ES, ESOff]
Status 1/After-call work state	ES Status, ES1 [ES, ES1]
Status 2/Available	ES Status, ES2 [ES, ES2]
System Programming	Designate either Hotel or Calling Group/CMS mode: ■ Options→Ext Status In Hotel mode, activate Extension Status on DLC: ■ Extensions→More→Ext Status
Hardware	Printer for reports



NOTE:

For more information about calling groups, see [“Group Calling”](#) on [page 350](#).

Description

Extension Status allows an operator, or a calling group or a Call Management System (CMS) supervisor with a Direct-Line Console (DLC), to monitor extension status. It provides alternatives to the standard call-handling LED indicators of Available, Busy, and Do Not Disturb. The red LEDs next to DSS buttons or the green LEDs next to Auto Dial buttons programmed with extension numbers are on, off, or flashing, depending on the extension’s status. The two modes for Extension Status that can be selected during system programming are as follows:

- **Hotel.** Employees at the front desk of a hotel or motel can use Extension Status to monitor room availability and restrict the telephones when the rooms are not occupied. [Table 20](#) shows Extension Status 0, 1, and 2 for Hotel mode and the associated LED status for each.

Hotel mode allows different meanings to be assigned to extension statuses. The system restricts or unrestricts telephones based on the meaning assigned.

- **Calling Group/CMS.** A calling group or CMS supervisor can use Extension Status to monitor the availability of agents who can take calls directed to the calling group. [Table 21](#) shows Extension Status 0, 1, and 2 for the Calling Group/CMS mode and the associated LED status for each.

In either Hotel or Calling Group/CMS mode, an operator, or a calling group or CMS supervisor with a DLC, can change the status of an extension either by using a programmed button or by pressing the Feature button and dialing a code. In addition, users in either mode with any type of telephone can change to Status 1 and Status 2. In calling groups, agents do not change to Status 1. In Calling Group/CMS mode, users can sign out of the group by changing to Status 0. In Hotel mode, an extension can be changed to Status 0 only from a DLC.

Table 20. Extension Status for Hotel Mode







Extension Status	LED Status	Meaning
0	Off 	Room is occupied and telephone is in regular call-handling state.
1	Flashing 	Room is unoccupied and ready for cleaning; outside calls cannot be made from telephone.
2	On 	Room is vacant and outside calls cannot be made from telephone.

Table 21. Extension Status for Calling Group/CMS Mode

Extension Status	LED Status	Meaning
0	Off 	Telephone is logged out from group; member is unavailable to take calls.
1	Flashing 	Used for CMS only; telephone is in after-call work state; group member is unavailable to take calls.
2	On 	Telephone is signed into group; calls can be sent to group member.

Considerations and Constraints

The system can be set up for either Hotel or Calling Group/CMS mode but not for both.

When DSS buttons are used to monitor status in Hotel mode, operators can use the Message Status button to see whether an operator turned on message LEDs at the telephones. In Calling Group mode, message status shows the busy/not busy status of the agents.

If a hotel has more than three floors and you want the first digit of each extension to correspond to its floor number—for example, Floor 5 has extensions 501 through 520—then you should use a MERLIN II System Display Console with built-in DSS buttons instead of DSS adjuncts. This is because the DSS buttons on the MERLIN II System Display Console correspond to the extension jacks instead of a range of extension numbers, as on the DSS adjunct. A DSS adjunct cannot have buttons for more than three ranges of numbers. The status of the first 120 rooms is displayed. If the hotel has more than 120 rooms, Auto Dial buttons can be assigned to up to 33 line buttons on the console to be used for Extension Status and for transferring calls to the rooms.

In Hotel mode, the MERLIN Mail, MERLIN LEGEND Mail, or AUDIX Voice Power outcalling feature does not work.

When Auto Dial buttons are used to monitor the status of telephones (instead of buttons on a DSS) in Hotel mode, the green LED next to the button indicates extension status (0, 1, or 2), and the red LED indicates message status. In calling group mode, the green LED also indicates extension status, but the red LED indicates busy/not busy status.

If the system is programmed for Extension Status in Hotel mode, telephones can be changed to Status 0 (regular call handling) only from the operator console.

Extension Status cannot be changed from rotary telephones.

When the system restarts (for example, for maintenance) in Hotel mode, and the calling group type is set for Auto Logout (see [“Group Calling” on page 350](#) for details), extensions that are assigned Status 1 are changed automatically to Status 0 and restrictions are removed. If the calling group type is changed to Auto Login, extensions assigned Status 1 are changed automatically to Status 2 and restrictions remain.

Telephone Differences

Direct-Line Consoles

Extension Status/Supervisory Operation can be assigned to DLCs only. In Hotel mode, only a DLC operator can change an extension to Status 0. In Calling Group/CMS mode, a calling group or CMS supervisor can use a DLC to monitor and change group member status.

Queued Call Consoles

Extension Status/Supervisory Operation cannot be used on a QCC; a QCC cannot be a calling group or CMS supervisor console or a calling group member.

Multiline Telephones

Only a telephone assigned as a DLC can be used to activate Extension Status/Supervisory Operation to view telephone status. In Hotel mode, the feature is assigned to the console in system programming; it remains active on the console unless the operator presses either the Message Status button to use Auto Dial or the DSS buttons to view message-waiting status for each telephone.

To activate Extension Status/Supervisory Operation in Calling Group/CMS mode, the calling group or CMS supervisor assigned as a DLC operator presses the Feature button, dials 32, and presses the Hold button. To deactivate the feature and return to normal call handling, the supervisor presses the Feature button, dials 32, and presses the Drop button.

To change the status of a telephone, a DLC operator or supervisor activates Extension Status (if not already active), then presses a programmed button for Status 0, Status 1, or Status 2, and finally presses the Auto Dial or DSS button for the telephone. A DLC operator or supervisor can also change the status of telephones by pressing the Feature button, dialing the feature code (760 for Status 0, 761 for Status 1, and 762 for Status 2), and pressing the Auto Dial or DSS button for the extension.



NOTE:

MLX display telephone users see only the first three characters dialed (for example, F76) when changing the status of telephones.

In either Hotel or Calling Group/CMS mode, regular multiline telephone users can change to Status 1 or Status 2 by pressing a programmed button for each status, or by pressing the Feature button and dialing the feature code (45 for Status 1 or 44 for Status 2). In Calling Group/CMS mode only, a user can change to Status 0 by pressing the Feature button and dialing *44.

Single-Line Telephones

Single-line telephone users can change to Status 1 (CMS or Hotel only) or Status 2 by lifting the handset, which must be connected to an ICOM or SA line, and dialing either #45 for Status 1 or #44 for Status 2. In Calling Group/CMS mode only, a user can change to Status 0 by dialing #*44.

Feature Interactions

Allowed/ Disallowed Lists and Calling Restrictions

To allow users in Hotel mode to dial emergency or other selected numbers when the telephone is in Status 1 or 2, access must be assigned to an Allowed List.

Callback

In Hotel mode, callback cannot be used on an extension in Status 1 or 2 to request busy pools.

Direct Station Selector

A calling group or CMS supervisor, or a DLC with Extension Status assigned, can change the status of a group member or room by pressing a programmed Available or Unavailable button and then pressing the DSS button for the group member or room.

Display

See [“Display” on page 271](#).

Do Not Disturb

The LED next to an Auto Dial or DSS button is on when the user activates Do Not Disturb or is busy on a call. In Release 2.0 and later systems, an MLX operator can inspect the DSS button to see if a Do Not Disturb message is posted.

Group Calling

Extension Status allows calling group supervisors to change and monitor calling group member status and to enable group members to sign in and out of the calling group.

HotLine

Extension Status is not recommended for HotLine extensions because HotLine extensions cannot dial the # codes to change the Extension Status.

Fax Extension

At a Glance

Users Affected	Telephone users, operators
Reports Affected	Direct Group Calling Information, Extension Directory, Extension Information, Label Information
Modes	All
Telephones	Tip/ring for fax extension. All for message-waiting receiver.
System Programming	Identify fax extension jacks: <ul style="list-style-type: none"> ■ AuxEquip→Fax→Extension Assign fax message-waiting receivers: <ul style="list-style-type: none"> ■ AuxEquip→Fax→Msg Waiting Specify length of time before system sends fax message-waiting indication: <ul style="list-style-type: none"> ■ AuxEquip→Fax→Threshold
Maximums	
Fax machines using the Fax Extension feature	16
Message-Waiting Receivers programmed for each fax extension	4
Factory Setting	
Fax Message Threshold	10 seconds (range 0–30)

Description

The Fax Extension feature provides special treatment for single-line ports (ports on 012 (T/R) or 016 (T/R) modules and ports programmed for tip/ring operation on 412 LS-ID-ETR and 016 ETR modules) when used with a facsimile machine or fax modem. This special treatment disables those features normally provided to single-line ports but not suitable for fax machines, such as:

- Distinctive ringing
- Call Waiting
- Transfer, Hold, and Conference

In addition to the above, the Fax Extension feature also provides the ability to notify certain extensions when a fax is received by turning on the Message LED. Extensions so enabled are called fax message-waiting receivers.

The Fax Message Threshold setting is the length of time (0–30 seconds) before the system assumes that a fax has arrived. When a fax extension answers a call, the MERLIN LEGEND Communications System waits until the fax message threshold is exceeded and then sends a message-waiting indication to the designated message-waiting extensions(s). If the message-waiting telephone has a Message LED, the Message LED turns on. Single-line telephone users without a Message LED hear a stutter dial tone when a message is waiting. Telephones located off premises are unable to receive message-waiting indications.

Return Call is not operable for messages received from a fax machine and cannot be used to make a call to the fax. (Return Call is a feature available on MLX display telephones, including QCCs, that enables a user to automatically call an extension that has left a message.)

The Fax Extension feature overrides the distinctive ringing pattern for calls transferred to a fax extension. When a fax extension receives a transferred call, it provides one long ring (similar to an inside call) instead of three short rings.



NOTE:

Only fax extensions can send message-waiting indications. They cannot receive message-waiting indications.

To use the Fax Extension feature, perform the following system programming tasks for each fax machine:

1. Specify the tip/ring extension connected to the fax machine or fax modem.
2. Specify the extension or extensions to receive the message-waiting indication.
3. Specify the number of seconds the system waits before it registers that a fax has arrived and sends the message-waiting indication. (This is the Fax Message Threshold, which is a systemwide parameter.) The range is 0–30 seconds, with a default of 10 seconds.



NOTE:

It is recommended that the default setting (10 seconds) be used for the Fax Message Threshold. If the Fax Message Threshold is set to less than 10 seconds, the Message LED could be activated on a receiver's telephone every time the fax machine goes off hook to answer a call, even if a fax has not arrived. If the Fax Message Threshold is set to more than 10 seconds, there is a greater likelihood that the Message LED will not be activated on a receiver's telephone whenever short faxes (that is, fax transmissions of less than 10 seconds in duration) arrive.

Considerations and Constraints

A fax extension can send a message-waiting indication, but it cannot be assigned as a message-waiting receiver for another fax or for a calling group.

If a fax message-waiting indication is deleted by one of the four message-waiting receivers, the message is deleted from all of the telephones programmed as message-waiting receivers for the fax.

This feature should not be used for fax machines connected to analog multiline telephones with a General Purpose Adapter (GPA). In a GPA configuration, features cannot be assigned to the fax independently of the telephone.

A maximum of 16 fax machines (tip/ring ports) can be assigned the Fax Extensions feature. Additional fax machines can be installed, but these additional fax machines cannot use the Fax Extension feature.

Feature Interactions

Conference	If an extension is programmed as a fax extension, the Conference feature cannot be used.
Display	<p>On MLX and ETR display telephones, message-waiting indications received by a fax message-waiting receiver are identified as <code>FAX</code>. On MLS and analog multiline telephones, messages are indicated by <code>Call</code> plus the extension or caller's name.</p> <p>The type of message indicated does not allow a calling group message-waiting receiver to distinguish between a message left for the calling group and a fax or personal message.</p>
Group Calling	The calling group receives fax message-waiting indications directed to the calling group. The message-waiting receiver cannot distinguish between messages left for the calling group and fax or personal messages.
Hold	If an extension is programmed as a fax extension, the Hold feature cannot be used.
Messaging	Return Call is not operable for messages received from a fax machine and cannot be used to make a call to the fax.
Multi-Function Module	A single-line telephone with a Message LED connected to an MFM can receive message-waiting indications, but not stutter dial tone.
Ringling Options	The Fax Extension feature overrides the distinctive ringing pattern for transferred calls. When a call is transferred to a fax extension, one long ring sounds (similar to an inside call), instead of three short rings.
Transfer	If an extension is programmed as a fax extension, the Transfer button cannot be used.

Features

Forced Account Code Entry

325

Forced Account Code Entry

See [“Account Code Entry/Forced Account Code Entry”](#) on page 30.

Forward and Follow Me

At a Glance

Users Affected	Telephone users, operators
Reports Affected	Extension Information, Operator Information
Modes	All
Telephones	
Sending	All except QCC
Receiving	All
Programming Code	
Forward	*33
Feature Codes	
Forward On	
To inside extension	33 + ext. no.
To outside number	33 + dial-out code or *, + optional Pauses, + outside no. + # (Centrex Transfer via Remote Call Forwarding, Release 6.0 and later: * + Pause)
Follow Me On	34 + sending ext. no.
Forward/Follow Me Off	
At sending extension	33 + sending ext. no.
At receiving extension, for one sending extension	*34 + sending ext no.
At receiving extension, for all sending extensions	*34*
MLX Display Labels	Forward [Forwd] Follow Me [FlwMe] Canc1Follow (QCC only)
System Programming	Allow (or disallow) individual extensions to forward calls to outside telephone numbers (Remote Call Forwarding): <ul style="list-style-type: none"> ■ Extensions→More→Remote Frwd Assign or remove principal user of a personal line (only the principal user can use Remote Call Forwarding for calls on the personal line): <ul style="list-style-type: none"> ■ LinesTrunks→More→PrncipalUsr Assign the number of rings that a call rings at an extension before it is forwarded (Forwarding Delay): <ul style="list-style-type: none"> ■ Extensions→More→Delay Frwd→extension no.→Enter→no. of rings→Enter
Factory Settings	
Forwarding Delay	0 rings (range 0–9 rings)
Remote Call Forwarding	Disabled

Description

Forward and Follow Me provide two ways for a user to send calls to another number. Calls can be forwarded to:

- An inside extension—for example, when a user is temporarily working at a different desk.
- A non-local extension at another system in a private network (Release 6.0 and later systems, Hybrid/PBX mode only)—for example, when a user is at a branch office.
- An outside number—for example, when a user is working at home. When calls are forwarded to an outside number, the feature is called Remote Call Forwarding.

In Release 4.0 and prior systems, an SA or ICOM line must be ringing at a forwarding extension before an inside call can be sent to the programmed destination, even when the programmed Forwarding Delay is 0 rings (factory setting). In Release 4.1 and later systems, the Forward on Busy feature enhancement forwards calls immediately when all available SA or ICOM buttons on the Forwarding extension are busy. The caller no longer receives a busy signal from the forwarding extension. This enhancement works with Forward, Follow Me, and Remote Call Forwarding.



NOTE:

Calls forwarded to outside telephone numbers may vary in transmission quality.

In Release 4.0 and later systems, both Forward and Follow Me are affected by the Forwarding Delay option, which allows calls to an extension to ring for *at least* the programmed number of rings (0–9) before the call is forwarded to the receiving extension. If a call cannot be forwarded while certain conditions exist, the Delay may be greater than the programmed Forwarding Delay setting. The Forwarding Delay setting can be programmed only by the system manager through system programming.

In Release 4.1 and later systems, SA or ICOM calls forwarded from an extension where all available lines are busy do not have the Forwarding Delay applied. They are forwarded immediately and may arrive at the destination before other forwarded calls that are ringing for the Forwarding Delay period.

All users, except QCC operators, can use Forward or Follow Me to forward calls to another extension. Calls cannot be forwarded to a calling group.

The factory setting for Remote Call Forwarding does not permit users to forward calls to outside numbers. Through system programming, use of the feature can be allowed for individual extensions.

Forwarding in a Private Network

The use of Forward and Follow Me in private-networked systems is as follows:

- In Release 6.1 and later systems (Hybrid/PBX mode only), you can use Call Forwarding to forward calls directly to a non-local extension across a private network. You do not have to enable Remote Call Forwarding. When programming call forwarding to a non-local extension, add # at the end of a number.
- For Release 6.0 and later systems, Follow Me is not supported across a private network.
- For Release 6.0 systems (Hybrid/PBX mode only), Remote Call Forwarding can be used in combination with Caller ID on a loop-start PSTN line connected to a module with Caller ID capability. The LS-ID Delay option must be programmed to On for each line connected to the module. To pass Caller ID information across the private network when a call is transferred, set the Remote Call Forwarding Delay to one ring. Transfer of the call must be completed before the call is forwarded.

The user at the extension that first receives the Caller ID call from the PSTN must turn Remote Call Forwarding on and specify forwarding across the private network, over PRI tandem trunks only, to a non-local extension with an MLX, ETR, or MLS display telephone. When the call is received on the destination MLX, ETR, or MLS display telephone, the user sees the Caller ID information.

Redirected transfer calls do not forward across the network.



SECURITY ALERT:

Remote Call Forwarding allows a user to forward an incoming call to an outside number. When a call is placed to the extension that is forwarding calls to an outside number, the caller can stay on the line after the call is concluded and receive another dial tone. At this point, the caller can initiate a toll call. For additional information, see [Appendix A, "Customer Support Information."](#)



CAUTION:

Make sure that calls are not forwarded back and forth between private network users because facilities will be tied up. For example, if a user at System A forwards calls to a user at System B, and the user at System B forwards them back to the user at System A, the call bounces back and forth tying up facilities along the way until all trunks are busy. If PRI tandem trunks are used, this forwarding can tie up all 23 channels on the T1 facility.



NOTE:

Transfers redirected by a voice messaging system (VMS) can be forwarded or can fail to be forwarded according to the following scenarios:

- If the VMS-transferred call arrives over Tie lines or PRI private network trunks and the call is not answered, the call arrives on a System Access button and is Remote Call Forwarded.
- If the VMS transfers the call to a local invalid extension or times out at a local extension, the call is delivered on the incoming Personal Line and is *not* Remote Call Forwarded.
- If the VMS transfers the call over a PRI private network trunk to a non-local extension with Do Not Disturb activated, the call alerts at the Private Line and is *not* Remote Call Forwarded.
- Unassigned DID calls are Remote Call Forwarded.

Centrex Transfer via Remote Call Forwarding

In Release 6.0 and later systems, in full and limited Centrex systems, Centrex Transfer via Remote Call Forwarding allows the remote call forwarding of outside calls that arrive on Centrex loop-start facilities. In this context, the term *outside calls* refers to calls from outside the communications system, which may originate at an extension in the Centrex system that is not connected to the local MERLIN LEGEND Communications System or anywhere in the PSTN. This saves line/trunk resources. Full details of this operation and its feature interactions are discussed in [“Forward and Follow Me” on page 326](#).

When an eligible call arrives and the feature is active, Centrex Transfer via Remote Call Forwarding sends a switchhook flash to the central office, which puts the call on hold and supplies Centrex dial tone for the call. The communications system then dials the programmed Remote Call Forwarding sequence and hangs up, completing the transfer and leaving the line open for other calls.

The following rules apply to Centrex Transfer via Remote Call Forwarding:

- Only outside calls arriving on loop-start Centrex lines can be forwarded by using this feature. Inside calls originating locally or anywhere on a private network, using private network facilities, can be remote call-forwarded, but regular Remote Call Forwarding should be used instead.
- The system must be equipped with analog Centrex loop-start lines/trunks. All analog loop-start lines in the system must be Centrex facilities. Other types of facilities can be used in the limited Centrex configuration, but calls arriving on these facilities cannot be remote call-forwarded.
- To transfer calls outside the Centrex system, an organization must subscribe to a Centrex trunk-to-trunk transfer feature. Otherwise, the feature only works for forwarding to Centrex system extensions that are, for example, not connected to the communications system.
- Transfers with consultation and conferences cannot be performed for extensions that have Centrex Transfer via Remote Call Forwarding active. Similarly, in a limited Centrex configuration that includes an Automated Attendant application, that application must support and be set to unsupervised transfer operation.
- The Centrex lines, the extensions programmed for Centrex Transfer via Remote Call Forwarding, and any Automated Attendant (limited Centrex configuration) that transfers calls to the extensions must be connected to the same switch. The feature is not supported across private networks (Release 6.0 and later systems, Hybrid/PBX mode only).
- Extension programming of Centrex Transfer via Remote Call Forwarding may require the Pause character. If so, a user at a multiline telephone on the communications system in a limited Centrex configuration can program the feature. If the feature with a dialing Pause is required for a single-line telephone, a user on the system must use the Authorization Codes feature in order to activate or deactivate Centrex Transfer via Remote Call Forwarding.

When a user activates or deactivates a forwarding feature by dialing his or her authorization code, the activating and forwarding extensions must be on the local switch. After dialing the authorization code, the user then turns the feature on or off normally.

- Reliable disconnect on loop-start lines is not required for Centrex Transfer via Remote Call Forwarding.

When extensions are using the Centrex Transfer via Remote Call Forwarding feature, do not program Music-On-Hold as the transfer audible. If Music-On-Hold is programmed in this case, a caller being transferred hears a click, three seconds of Music-On-Hold, a second click, then silence for about 10 seconds, then a

ringback or a busy tone from the central office. This can confuse outside callers, who may hang up.

Two SMDR call records can be generated for Centrex remote call-forwarded calls: one for the incoming or transferred call to the extension and one for the outgoing call to the remote telephone number. In order for SMDR to report the calls, the SMDR minimum call length must be set to zero (0).

Activating Centrex Transfer via Remote Call Forwarding is just like activating regular Remote Call Forwarding and requires that Remote Call Forwarding be enabled for the extension. The user dials * instead of a dial-out code, however. A Pause character may be required after the * as determined by the Centrex service provider.

If the Pause is required at a single-line telephone, the user must employ an authorization code to activate the feature from a multiline extension. A user may activate or deactivate forwarding or Centrex Transfer via Remote Call Forwarding by dialing his or her authorization code from an extension other than the home extension. The activating and forwarding extensions must be on the local switch. The user activates the feature after dialing the authorization code and hearing inside dial tone. The user must activate or deactivate the forwarding feature within 15 seconds of entering the authorization code; otherwise, it is necessary to start over.



NOTE:

A remote access user cannot dial the Pause character in the Remote Call Forwarding digit string.

If a Pause is not required, a single-line telephone user may activate the feature at his or her own extension. A remote access user may activate the feature without using an authorization code. Barrier code requirements do apply, however.

Use of Forward or Follow Me

Whether calls are sent by using Forward or using Follow Me depends on where the feature is activated:

- Forward and Remote Call Forwarding are activated at a user's own extension or from an outside telephone by remote access. Forward can be deactivated at a user's own extension, at a local extension to which the user's calls are forwarded, or from an outside telephone by remote access. (System programming is required to allow Remote Call Forwarding.) Forward to a non-local extension can be activated only at the user's own extension.
 - In Release 6.0 and later systems (Hybrid/PBX mode only), Follow Me is not supported across a private network.

- In Release 6.0 (Hybrid/PBX mode only), Forward is not supported across a private network.
 - In Release 6.1 and later systems (Hybrid/PBX mode only), Forward is supported across a private network.
 - In Release 6.0 and later systems, a user with an authorization code can turn Forward or Remote Call Forwarding on or off from a multiline telephone at another extension in the local system. The user first dials the authorization code for his or her home extension and then activates the feature normally. A single-line telephone user and a remote access user cannot enter the Pause character, if required, in a Remote Call Forwarding digit string.
- Follow Me is activated at another local extension to send a user's calls to that local extension. It can be deactivated at a user's own extension or at the local extension to which calls are sent. Follow Me can be used only to send calls to a local extension, not to an outside telephone number or non-local extension.

If calls are being sent from several extensions, the user can turn off Forward and Follow Me either for one extension at a time or for all extensions.

Call Eligibility for Forwarding Features



NOTE:

In Release 6.0 and later systems, when the Centrex Transfer via Remote Call Forwarding feature is used, only outside calls arriving on analog Centrex loop-start lines are remote call-forwarded. (Such calls may arrive directly at the extension or be transferred without consultation.) Centrex Transfer via Remote Call Forwarding is an exception to many of the eligibility rules listed below for other types of forwarding.

Forward, Remote Call Forwarding, and Follow Me send the following types of calls:

- In Release 4.1 and later systems, all inside calls when all SA or ICOM buttons are busy.
- In Release 4.0 and prior systems, ringing inside calls.
- Inside or outside calls transferred to the forwarding extension.
- Outside calls directed to the forwarding extension and received on a tie trunk.
- Outside calls received on a Direct Inward Dialing (DID) trunk.

- Outside calls received on PRI lines with routing by dial plan.
- For Release 6.0 or later systems (Hybrid/PBX mode only), private network calls.

An available calling group member is automatically logged out when the member forwards his or her calls. If a calling group member logs in while calls are being forwarded, Forward or Remote Call Forwarding is automatically canceled.

Forward, Remote Call Forwarding, and Follow Me do not send the following types of calls:

- Voice-announced inside calls.
- Calls received on a Cover button.
- Returning parked or transferred calls.
- Callback calls from the system.
- Calls received on a Shared SA button.
- Calls received on a Call button on a QCC.
- Calls transferred from a calling group for a voice messaging system (VMS) connected to a jack programmed as generic VMI.
- Calls forwarded from other extensions.

Calls received on a personal line (an outside line assigned to a button on the telephone) are forwarded to outside numbers by using Remote Call Forwarding only under the following circumstances:

- The extension must be assigned as the principal user of the personal line through system programming. Only one extension can be the principal user for a given line/trunk.
- If the personal line is a loop-start line, it must provide a reliable disconnect signal. A disconnect signal is the signal sent by the local telephone company to notify the system that an outside caller has hung up. Disconnect signaling is considered reliable when a disconnect signal is sent on every call when the caller hangs up. The line is considered unreliable when a disconnect signal is not sent on every call. The factory setting for loop-start lines is Unreliable Disconnect; this setting can be changed to Reliable Disconnect through system programming. Remote Call Forwarding cannot be used to forward calls arriving on a line programmed as unreliable.



NOTES:

- Programming a loop-start line as reliable when, in fact, it does not provide reliable disconnect signaling leaves the line in a permanent busy condition after a call on that line has been forwarded to an outside number.
- In Release 6.0 and later systems, Centrex loop-start lines used for Centrex Transfer via Remote Call Forwarding do *not* have to provide reliable disconnect.
- T1-emulated loop-start lines are considered unreliable and should not be used for Remote Call forwarding.

Forwarded Call Ringing

A forwarded call rings as shown in [Table 22](#).

Table 22. Forwarded Call Ringing

Telephone Type	Calls Forwarded to Inside Extension	Outside Number
Multiline	<p>In Release 4.1 and later systems, if SA or ICOM buttons are all busy, the call is forwarded immediately, regardless of the delay setting.</p> <p>In Release 4.0 and prior systems, the forwarding telephone must ring once for an SA or ICOM call. If all SA or ICOM buttons are busy, the caller hears the busy tone and the call is not forwarded.</p> <p>If an SA or ICOM button is available, the green LED continues flashing; the call can still be answered.</p> <p>The receiving telephone rings, and the green LED flashes at an available SA or ICOM button until the call is answered.</p>	Forwarding telephone does not ring. Destination telephone rings.
Single-line	<p>In Release 4.0 and prior systems, the forwarding telephone rings until the call is answered. If the SA or ICOM line is busy, the caller hears a busy tone and the call is not forwarded. In Release 4.1 and later systems, if the SA or ICOM line is busy, the call is forwarded immediately, regardless of the delay setting.</p> <p>The destination telephone rings, and the green LED flashes at an available SA or ICOM button until the call is answered.</p>	Forwarding telephone does not ring. Destination telephone rings.

Delayed Forwarding

In Release 4.0 and later systems, each user can program a Forwarding Delay setting for calls that are forwarded using Forward, Remote Call Forwarding, or Follow Me. The Forwarding Delay is the number of rings allowed at the forwarding extension before it is forwarded to the receiver. The number of rings can be set from zero to nine (0–9) through system programming. Once the Forwarding Delay is programmed, it remains in effect until it is reprogrammed.

The user can use this feature to screen calls during that time by checking the displayed calling number if it is available.

Do Not Disturb overrides Delayed Forwarding. Calls are immediately forwarded if Do Not Disturb is on while Forward or Follow Me is active.

In Release 4.1 and later systems, if a call arrives on an SA or ICOM line to a forwarding extension where all SA or ICOM buttons are busy, the call is sent immediately to its destination. The Forwarding Delay has no effect.

Considerations and Constraints

On multiline telephones, Forward should be programmed on a button so that the LEDs provide a visual reminder when calls are being forwarded.

A user can forward calls to only one extension or outside telephone number.

A user can receive forwarded calls from an unlimited number of extensions.

Forward (including Remote Call Forwarding) and Follow Me cannot be used at the same time. When the second feature is turned on, the first one is automatically turned off.

In Release 4.1 and later systems, the call need not ring when all SA or ICOM buttons are busy. A call forwarded to an outside number does not ring at the forwarding telephone. A call forwarded to a single-line telephone rings until the call is answered. In Release 4.0 and prior systems, an SA or ICOM call to an MLX or analog multiline telephone extension must ring once at the forwarding telephone, or according to the programmed Forwarding Delay in Release 4.0 systems. It rings until answered at an available SA or ICOM button on the destination telephone (see [Table 22](#)).

A forwarded outside call rings as an inside call (one-ring burst) at the destination extension; it does not ring with the normal distinctive ring for an outside call.

The ability to use Remote Call Forwarding to forward calls received on a personal line to an outside number must be assigned through system programming. If this

ability is assigned, only the principal user of a personal line can forward calls on that line to an outside number. If a principal user is not assigned, calls on a personal line cannot be forwarded to an outside number. When the principal user turns on Remote Call Forwarding, all calls received at that extension on an SA or ICOM button are forwarded to the outside number. Only one inside call at a time can be forwarded. Multiple outside calls, however, can be forwarded. No error tone sounds when a user with a restricted telephone uses Remote Call Forwarding. When a call eligible for forwarding is received, however, the system checks restrictions and denies the forward if the outside telephone number either is not on an Allowed List assigned to the restricted extension or is included on a Disallowed List assigned to the restricted extension.

If a user who is off hook on an SA or ICOM button turns on Forward, Remote Call Forwarding, or Follow Me, and enters an invalid destination, an error tone sounds. On an MLX or ETR display telephone, the display clears. If a user enters an invalid extension while turning on Forward, Remote Call Forwarding, or Follow Me at an MLS or analog multiline display telephone, `ERROR` appears on the display.

Reliable disconnect cannot be programmed for a T1 channel programmed to emulate a loop-start line. When a call is received on a loop-start emulation channel and Remote Call Forwarding is used, the call is forwarded to the primary system operator instead of to the destination telephone number.

A user who shares a personal line cannot join a call in progress forwarded to an outside telephone number, unless the user shares both the personal line on which the call was received and the line/trunk selected to forward the call to the outside number.

When two or more people sharing a personal line use Forward or Follow Me to send to extensions, calls received on the personal line are forwarded to all destinations.

If Forward is turned on at an extension while it is ringing with an incoming call, the call continues to ring at that extension and also begins to ring at the destination extension after the delay time interval.

Forward, Remote Call Forwarding, and Follow Me forward a call only once. For example, if Extension A forwards calls to Extension B, which in turn is forwarding calls to Extension C, calls arriving for Extension A are forwarded only to Extension B and do not go on to Extension C.

Calls received on a Cover button are not forwarded. When a coverage sender turns on Forward, his or her calls are forwarded and go to coverage at the same time.

A call can be forwarded to a multiline telephone that has a DSS or Auto Dial button for the originator. When this occurs in Release 2.1 and later systems, the

red LED next to the DSS button or the green LED next to the Auto Dial button does not flash.

The reasons that a call may ring for more than the programmed Delayed Call Forwarding setting are the following:

- If a button is programmed as Delayed Ring, the Forwarding Delay begins after the Delayed Ring period ends. The two delays are cumulative.
- The destination for the Forwarded call may not be available to receive the call.
- No lines/trunks may be available (Remote Call Forwarding only).

Unless a forwarding delay is active, remote call-forwarded calls do not ring at the forwarding extension. No display is shown.

In Release 4.0 and later systems, if the Forwarding receiver is unavailable, a call rings at the Forwarding extension (assuming a button is available) until the Forwarding receiver is available or the call is answered. If a call is forwarded to a line/trunk through Remote Call Forwarding, the call rings at the forwarding extension until a line/trunk is seized for the outgoing call.

In Release 4.1 and later systems, if all SA or ICOM buttons are busy at the forwarding extension and the receiving extension is also unavailable, the caller receives a busy signal.

In Release 4.0 and prior systems, a call arriving on an SA or ICOM line to a busy forwarding extension is not forwarded. The caller hears a busy tone.

The Forwarding Delay setting cannot be copied from one extension to another, because it is not associated with a button.

In Release 4.1 and later systems, an SA or ICOM call placed to a forwarding extension with no available SA or ICOM buttons is forwarded immediately. As a result, the call may arrive before other forwarded calls that are still ringing according to a programmed Forward Delay setting.

Forward on Busy (Release 4.1 and later systems only) is automatic and cannot be changed through programming. It is not activated when the forwarding telephone is busied-out for maintenance or system programming, or when the forwarding telephone is unplugged or in extension or system programming mode.

In Release 3.1 and later releases, Remote Call Forwarding checks the dial-access-to-pools restriction and denies the call if pool access is restricted.

In Release 6.0 and later systems using full or limited Centrex features, outside calls can be remote call-forwarded to outside telephone numbers. The outside

calls must arrive on analog Centrex loop-start lines (reliable disconnect not required).

Telephone Differences

In Release 6.0 and later systems, you can activate or deactivate Forward or Remote Call Forwarding from a local system telephone by first entering your authorization code. When you hear an inside dial tone, you press the Feature button and dial 33, or dial #33 or *33, depending on the type of telephone at the extension you are using. Activating the feature using an authorization code follows the same rules as other activations of Forward. (The sections below provide details.) You cannot activate Follow Me by using this method, nor can you activate any other feature at your home extension.

Direct-Line Consoles

A DLC operator can forward calls to extensions and, if allowed through system programming, to outside telephone numbers. Because outside lines are assigned as personal line buttons on the console, the ability to forward calls received on each eligible outside line (excluding loop-start lines with unreliable disconnect on non-Centrex systems) to an outside number must also be assigned through system programming; the outside line can be assigned to only one telephone for each individual line/trunk.

Queued Call Consoles

Calls cannot be forwarded from a QCC to another extension or an outside number. (A QCC operator uses Position Busy instead.) Users can forward calls to an individual QCC, however.

To turn on Follow Me for another local extension at a QCC, press the Feature button and select the Follow Me feature from the display. At the prompt, dial the local extension of the forwarding telephone.

To cancel Forward and Follow Me from other local extensions, press the Feature button at the destination QCC, and select `CancelFollow` (Cancel Follow Me) from the display. Then do either of the following:

- To cancel forwarding from one local extension, dial that extension number.
- To cancel forwarding from all local extensions, dial *.



NOTE:

Forward from non-local extensions must be cancelled at the extension forwarding the calls.

Other Multiline Telephones

To forward calls to an extension, either press a programmed Forward button and dial the destination extension number, or press the Feature button, dial 33, and dial the destination extension number. If you are forwarding to a non-local extension, dial a pound sign (#) after the non-local extension number. If you are off hook on an SA or ICOM button, you hear a confirmation tone (double-break in the dial tone), and then the dial tone is removed. If a programmed Forward button is used, the green LED next to the button turns on.

To forward calls to an outside telephone number, either press a programmed Forward button, or press the Feature button and dial 33. Then select the outside line/trunk or pool on which to route forwarded calls by dialing the ARS or pool dial-out code (Hybrid/PBX mode only), the Idle Line Access code (usually 9; Key and Behind Switch modes only), the line/trunk number (usually 801–880), or * (Centrex line, any mode). If you are using Centrex Transfer via Remote Call Forwarding, you may need to press the Hold button to enter a 1.5-second Pause character; consult your Centrex provider. Press Hold at any time after entering the dial-out code, line/trunk number, or *. Then dial the destination telephone number followed by a pound sign (#) to signal the end of the dialing sequence.

If you are off hook on an SA or ICOM button, you hear a confirmation tone, and then the dial tone is removed. If a programmed Forward button is used, the green LED next to the button turns on.

To turn on Follow Me, press the Feature button, dial 34, and dial the forwarding telephone's extension. If you are off hook on an SA or ICOM button, you hear a confirmation tone, and then the dial tone is removed. An MLX display telephone user can also use Follow Me by pressing the Feature button, selecting the feature from the display, and dialing the forwarding telephone's extension.

In Release 6.0 and later systems, you can activate or deactivate Forward or Remote Call Forwarding from a local system multiline telephone by first entering your authorization code. When you hear inside dial tone, press the Feature button and dial 33, or dial #33 or *33, depending on the type of telephone at the extension you are using.

To turn off Forward, Remote Call Forwarding, and Follow Me at the originating multiline telephone, press the programmed Forward button, or press the Feature button and dial 33; then dial your own extension number (in effect, "forwarding" calls to that extension). If you are off hook on an SA or ICOM button, you hear a confirmation tone, and then dial tone is removed. If a programmed Forward button is used, the green LED next to the button turns off.

At a destination (receiving) multiline telephone, to cancel Forward and Follow Me from other local extensions, press the Feature button, dial *34, and do either of the following:

- To cancel forwarding from one local extension, dial that extension.
- To cancel forwarding from all local extensions, dial *.



NOTE:

Forward from non-local extensions must be cancelled at the extension forwarding the calls.

If you are off hook on an SA or ICOM button, you hear a confirmation tone, and then the dial tone is removed.

Single-Line Telephones

At a single-line telephone, you must connect to an SA or ICOM line to turn on Forward or Follow Me to an extension or outside line.

To forward to a local extension, lift the handset and then dial #33, followed by the destination extension number. If you are forwarding to a non-local extension, dial a pound sign (#) after the non-local extension number. You hear a confirmation tone, which is a double-break in the dial tone, and then the dial tone is removed.

To forward calls to an outside telephone number, lift the handset and dial #33. Select the outside line/trunk or pool on which to route forwarded calls. Dial the ARS or pool dial-out code (Hybrid/PBX mode only), the Idle Line Access code (usually 9; Key and Behind Switch modes only), the line/trunk number (usually 801–880), or * for Centrex Transfer via Remote Call Forwarding (Release 6.0 and later systems). Then dial the destination telephone number followed by a pound sign (#) to signal the end of the dialing sequence. You hear a confirmation tone, and then the dial tone is removed.



NOTE:

In Release 6.0 and later systems using Centrex Transfer via Remote Call Forwarding, a Pause character may be required after the * that you dial for Centrex line access. Because entering a Pause character requires use of a system Hold button, a Pause cannot be entered from a single-line telephone; use the Authorization Code feature to activate forwarding from a multiline extension.

To turn on Follow Me, lift the handset and dial #34 and your own extension number. You hear a confirmation tone, and then the dial tone is removed.

To cancel Forward, any type of Remote Call Forwarding, or Follow Me at the originating single-line telephone, lift the handset and dial #33 and your own extension number, in effect, “forwarding” calls to that extension. You hear a confirmation tone, and then the dial tone is removed.

At a destination single-line telephone, cancel Forward and Follow Me from other extensions by lifting the handset and dialing #*34. Then do either of the following:

- To cancel forwarding from one local extension, dial that extension number.
- To cancel forwarding from all local extensions, dial *.



NOTE:

Forward from non-local extensions must be cancelled at the extension forwarding the calls.

If you are off hook on an SA or ICOM button, you hear a confirmation tone. Then dial tone is removed.

Calls are forwarded to single-line telephone extensions even if there is no telephone or other tip/ring device connected to the specified extension.

Feature Interactions

Account Code Entry

You cannot enter account codes for calls forwarded to outside numbers. Account codes are not necessary for calls forwarded to extensions.

On telephones with Forced Account Code Entry assigned, you can forward calls only to local extensions and not to outside telephone numbers. If the extension has Remote Call Forwarding on with an outside number programmed and Forced Account Code Entry is activated, then Remote Call Forwarding is overridden and calls ring only at the extension.

Allowed/ Disallowed Lists and Calling Restrictions

With an outward- or toll-restricted telephone, you cannot forward calls to an outside number unless the number is on an Allowed List assigned to the restricted extension. With a restricted telephone, no error tone sounds when you use Remote Call Forwarding or Centrex Transfer via Remote Call Forwarding (Release 6.0 and later systems). When a call eligible for forwarding is received, however, the system checks restrictions and denies the forward if the outside telephone number is not on an Allowed List (or is on a Disallowed List) assigned to the restricted extension.

- Authorization Code** In Release 6.0 and later Key or Hybrid/PBX mode systems, you can activate or deactivate forwarding features, including Centrex Transfer via Remote Call Forwarding but excluding Follow Me, at an extension on the system by entering the authorization code for the extension on the same system from which calls are to be forwarded. You enter the authorization code, then activate or deactivate the feature in the normal fashion. This is especially useful for a single-line telephone user who must include a Pause character in a Remote Call Forwarding dialing sequence, since this character cannot be dialed at a single-line telephone. It is also useful when forwarding options must be changed for a phantom extension.
- Auto Answer All** An answering device connected to an analog multiline telephone can answer forwarded calls when Auto Answer All is turned on.
- Auto Dial** When a call is forwarded to a multiline telephone that has an Auto Dial button programmed for the forwarding telephone, the green LED next to the Auto Dial button does not flash.
- An Auto Dial button cannot be used to dial digits for any type of Remote Call Forwarding.
- Automatic Route Selection** To have ARS select the facility on which to forward calls to an outside telephone number, you enter the ARS code before the telephone number. The FRL for the call is that of the extension *from* which calls are being forwarded.
- Barge-In** When a forwarded call is answered at the destination extension, Barge-In can be used to join the call only by dialing the extension number for the destination (not the number for the originating extension). Barge-In cannot be used to join a call forwarded to an outside telephone number.
- Callback** If a forwarding extension is busy when a user calls, the user can queue the call for callback. Callback is completed when the forwarding extension is no longer busy. If the forwarding extension and the forwarded-to extension are available, the call rings at both extensions. If the forwarded-to extension is not available, the call rings at the forwarding extension only.
- If an inside caller using Automatic Callback calls an extension with Remote Call Forwarding and no pools are available, the caller hears the queuing tone. When the pool becomes available, the dequeuing tone sounds and the call is placed to the Remote Call Forwarding number if the caller has stayed on the line. If the caller has hung up, a priority ring is heard as the callback call is dispensed to the user.
- When no pools are available and an inside caller is not using Automatic Callback, a call to an extension with Remote Call Forwarding follows the extension's coverage path. If there is no coverage and the inside caller activates Selective Callback while listening to the busy signal, the call queues for the extension, but not for the Remote Call Forwarding number.

- Caller ID** The systemwide LS-ID delay, if programmed, augments the Forwarding Delay. The total delay is the LS-ID delay plus the Forwarding Delay.
- In Release 6.0 and later systems (Hybrid/PBX mode only), Remote Call Forwarding can be used in combination with Caller ID on a loop-start PSTN line connected to a networked system's 800 GS/LS-ID, 408 GS/LS-ID-MLX (Release 7.0 and later systems), or 412 LS-ID-ETR (Release 7.0 and later systems) line/trunk module. This allows Caller ID information to be sent across a private network. The user at the extension that first receives the Caller ID call from the PSTN must turn Remote Call Forwarding on and specify forwarding across the network, over PRI tandem trunks only, to a non-local extension with an MLX, ETR, or MLS display telephone. When the call is received on the destination MLX, ETR, or MLS display telephone, the user sees the Caller ID information.
- In Release 6.1 and later systems (Hybrid/PBX mode only), Forward can be used to send calls to a non-local extension across a private network. Caller ID information is sent with the forwarded call if PRI tandem trunks connect the systems.
- Call Waiting** Call Waiting does not apply to forwarded calls because the system tries the destination telephone instead of the forwarding telephone. If the call is not forwarded for any reason (for example, because the user has tried to use Remote Call Forwarding from a restricted telephone), however, Call Waiting functions normally.
- In Release 4.1 and later systems, if no SA or ICOM buttons are available and Forward or Follow Me is turned on, the user does not hear the call-waiting tone when a call is forwarded using the Forward on Busy enhancement; instead the caller hears ringback.
- Camp-On** Camp-On cannot be used to complete a transfer to an extension that has any type of Remote Call Forwarding turned on.
- Conference** When calls received on a personal line are forwarded to an outside telephone number, another user who shares the personal line and the line/trunk selected to forward the call can join the in-progress call by pressing the personal line button. In this case, the person joining the call is considered the conference originator, and the forwarded call can be conferenced. If the person joining the call hangs up, all participants on the conference call are disconnected.
- In Release 6.0 and later systems, if you conference a call on a Centrex analog loop-start line when an extension has activated Centrex Transfer via Remote Call Forwarding, the call is not forwarded.
- Coverage** In Release 3.0 and earlier systems, or if the Forwarding Delay is programmed to 0 rings in Release 4.0 and later systems, when a coverage sender forwards, calls are forwarded and sent to coverage at the same time. Calls received on any Cover button are not forwarded.

Coverage (continued)

If a coverage receiver has activated any type of Remote Call Forwarding, calls sent to that extension by Coverage are not forwarded to the remote location.

In Release 4.0 and later systems, one of the following occurs if both coverage and forwarding are on and the Forwarding Delay is not set to 0 rings:

- A call that is sent to Group Coverage before the forwarding attempt is not forwarded.
- A call that is remote call-forwarded before any coverage is not covered.
- A call that is remote call-forwarded while Primary and/or Secondary Coverage receivers are alerting is removed from those coverage points and is not sent to Group Coverage.
- If a call is sent to Group Coverage after forwarding, the call is removed from the called extension, the forwarded-to extension, and any primary and secondary Cover buttons.
- If a user tries to forward a call before the coverage interval is reached, the call is not forwarded.

CTI Link

When an MLX extension is programmed as a CTI link (Release 5.0 and later systems only), forwarding is deactivated for that extension.

In Release 6.0 and later systems, if a PassageWay Telephony Services client extension with a call on an analog Centrex loop-start line attempts to conference or to transfer to an extension with Centrex Transfer via Remote Call Forwarding activated, the call is immediately transferred without consultation, regardless of the user's intentions. The originator is disconnected.

Digital Data Calls

Digital communications devices can forward calls by dialing the associated feature code.

Forward can be activated by video systems that have the ability to dial strings and feature codes beginning with #. 2B data calls are forwarded as two 1B data calls. Remote Call Forwarding features are not available at video system extensions.

Direct Station Selector

You can forward calls to a particular extension by pressing a programmed Forward button or by using the feature code, and then pressing a DSS button for that extension. If you are forwarding to a non-local extension, dial a pound sign (#) after the non-local extension number. You can activate Follow Me by using the feature code and pressing a DSS button corresponding to the local forwarding extension.

A call can be forwarded to a multiline telephone that has a DSS or Auto Dial button for the originator. When this occurs in Release 2.1 and later systems, the red LED next to the DSS button or green LED next to the Auto Dial button does not flash.

Direct Voice Mail

In Release 4.0 and later systems, if Forwarding is active and Delayed Forwarding is not set to zero rings, pressing the Direct Voice Mail button causes the call to go directly to voice mail coverage; the call does not get forwarded.

In Release 3.0 and later systems, a call that is transferred to an extension using Direct Voice Mail is not forwarded.

You cannot forward calls to your own extension, and you cannot use Direct Voice Mail to reach your own mailbox.

Display

When an MLX or ETR display telephone user forwards calls to an extension, the display prompts for the extension. After Forward is turned on, the MLX user sees a confirmation message; the ETR user does not. A user receiving a forwarded call sees a message indicating which extension forwarded the call. For an outside call, pressing More on the MLX or ETR telephone displays the line the call came in on and, if ISDN calling party identification or Caller ID is available, the caller's number. For an inside call, pressing More on the MLX telephone or ETR telephone shows the caller's name and extension.

When an MLX or ETR display telephone user forwards calls to an outside number, the display prompts for the number. On MLX, ETR, MLS, and analog multiline telephones, the digits appear on the display as the user dials the number. An MLX display telephone user receives a feedback message confirming that his or her calls are now forwarded to an outside number.

When an MLX or ETR display telephone user turns Follow Me on or off, the display prompts for the forwarding extension. After the feature is activated, the message *Signed In* appears on an MLX display telephone, but not on an ETR telephone. After the feature is deactivated, one of two messages appears on the MLX telephone:

- *Signed Out* if you deactivated the feature for one extension.
- *Signed Out : All* if you deactivated the feature for all extensions.

If an MLX or ETR display telephone user enters an invalid destination while turning on Forward, the display clears. If a user enters an invalid extension while turning on Forward, Remote Call Forwarding, or Follow Me at an MLS or analog multiline display telephone, *Error* is displayed.

Do Not Disturb

Calls are not forwarded to a destination extension that has Do Not Disturb turned on; the call rings only at the forwarding telephone as described in [Table 22 on page 334](#). Turning on Do Not Disturb at the forwarding extension does not prevent calls from being forwarded.

**Do Not Disturb
(continued)**

In Release 4.0 and later systems, turning on Do Not Disturb at a forwarding extension causes calls to be forwarded immediately. The Forwarding Delay has no effect.

In Release 6.0 and later systems (Hybrid/PBX mode only), calls forwarded to an extension on a remote system that has activated Do Not Disturb receive a busy tone or follow the coverage programmed for that extension.

Group Calling

An available calling group member is automatically logged out when the member forwards his or her calls. If a calling group member logs in while calls are being forwarded, Forward or any type of Remote Call Forwarding is automatically canceled.

Calls cannot be forwarded to a calling group.

When a line/trunk programmed to ring into a calling group is assigned as a personal line on a principal user's telephone, an incoming call received on the personal line is not sent to the calling group if the principal user forwards calls to an outside telephone number through Remote Call Forwarding or Centrex Transfer via Remote Call Forwarding.

HotLine

Forward and Follow Me are not intended for HotLine extensions (Release 5.0 and later systems), they can be used at these extensions. Forwarding must be programmed at the extension before it is assigned as a HotLine extension. Follow Me cannot be activated at a HotLine extension.

To cancel both Forward and Follow Me at a Hotline extension, you must use a telephone at a non-HotLine extension.

Although remote Call Forwarding is not intended for HotLine extensions, it can be programmed before the extension is assigned as a HotLine. To cancel Remote Call Forwarding, you must remove HotLine programming first.

**Multi-Function
Module**

Forward (including Remote Call Forwarding) and Follow Me should not be used on an MFM because there is no LED that indicates when the feature is active.

Music-On-Hold

In Release 6.0 and later systems where extensions are using the Centrex Transfer via Remote Call Forwarding feature, do not program Music-On-Hold as the transfer audible. If Music-On-Hold is programmed in this case, a caller being transferred hears a click, three seconds of Music-On-Hold, a second click, then silence for about 10 seconds, then ringback or a busy tone from the central office. This can confuse outside callers, who may then hang up.

- Night Service** When Night Service is turned on, calls arriving for a Night Service group member can be forwarded to a local extension by using Forward or Follow Me. Calls cannot be forwarded to an outside telephone number or a non-local extension, however.
- In Release 6.1 or later systems (Hybrid/PBX mode only), if the operator in charge of Night Service forwards calls to an outside number or a non-local extension, only calls received on lines to which the operator is assigned as the principal owner are forwarded. All other calls are not forwarded.
- Paging** Calls cannot be forwarded to a paging group. The line/trunk number used to connect loudspeaker paging equipment cannot be used to forward calls to outside telephone numbers.
- Park** Returning parked calls are not forwarded.
- Personal Lines** When an extension is programmed as the principal user of a personal line, calls arriving on the personal line can be forwarded to an outside number (if the extension can use Remote Call Forwarding) as long as the personal line is not a loop-start line with unreliable disconnect. (In Release 6.0 and later systems, reliable disconnect is not required for the Centrex Transfer via Remote Call Forwarding feature.)
- In Release 4.1 and later systems, the Forward on Busy enhancement does not apply to calls received on personal lines.
- Pickup** Pickup cannot be used to answer calls being forwarded to an outside telephone number.
- Pools** A pool can be used to forward calls to an outside telephone number. The pool dial-out code should be entered before the telephone number.
- Primary Rate Interface and T1** A PRI line that has been programmed for routing by dial plan cannot have Remote Call Forwarding allowed. A T1 Switched 56 line cannot be used for Remote Call Forwarding.
- Recall/Timed Flash** A multiline telephone user on an inside Forward or Follow Me call can use Recall. In Release 2.0 and later systems, Recall can also be used on an outside call received on a loop-start line.
- Remote Access** To turn on Forward or Remote Call Forwarding through Remote Access, call into the system on a line/trunk that is programmed for Remote Access and enter the barrier code, if required.
- To forward calls to an extension, dial *33 while listening to system dial tone. Then dial the forwarding extension number and the destination extension number. If the destination number is a non-local extension, dial a pound sign (#) after the extension number.

Remote Access (continued)

To forward calls to an outside telephone number, dial *33 and the forwarding extension number. Then dial one of the following: the ARS or pool dial-out code (Hybrid/PBX mode only), the Idle Line Access code (usually 9; Key and Behind Switch modes only), the line/trunk number (usually 801–880), or a * for Centrex Transfer via Remote Call Forwarding (Release 6.0 and later systems). Finally, dial the destination telephone number and # to signal the end of the dialing sequence. If a Pause is needed in the dialing sequence for Centrex Transfer via Remote Call Forwarding, forwarding must be activated or deactivated at a multiline telephone on the system.

To cancel the forwarding of calls to an extension, dial 33 while listening to system dial tone. Then dial the forwarding extension number; now dial the forwarding extension again.

Ringling Options

If the forwarding telephone is set to Immediate Ring, only the programmed Forwarding Delay is applied (Release 4.0 and later systems). If the forwarding telephone button is set to Delay Ring, calls that arrive on that button are delayed before forwarding. In Release 4.0 and later systems, the Forwarding Delay is added to the Delay Ring setting. If the forwarding telephone button is set to No Ring, calls that arrive on that button are not forwarded.

In Release 4.1 and later systems, a call that cannot arrive at the forwarding extension—because it has no available SA or ICOM button—is forwarded immediately. It does not ring at the forwarding extension, regardless of the Ring Timing options (Delay, Immediate, or No Ring) set.

Service Observing

In Release 6.1 and later systems a Service Observer actively observing an extension may activate or cancel Forward or Follow Me without interrupting the observing. The Service Observer simply presses the Feature button and dials the feature code and extension number. The Service Observer, however, does not hear any progress tones while doing this.

SMDR

If the system is programmed to track both incoming and outgoing calls, two SMDR records are generated when an outside call is forwarded to an outside telephone number. One record shows the incoming call, and the other record shows the call made to the destination telephone number with the forwarding telephone as the originator.

To program the Remote Call Forwarding number to which incoming calls are to be forwarded, press #. The SMDR report includes the # with the number for calls forwarded to the number. In Release 6.0 and later systems, if a Pause character is included in a Remote Call Forwarding dial sequence, it also appears in the report.

SMDR
(continued)

In Release 6.0 and later systems, when a call comes into an extension that is a principal user with Centrex Transfer via Remote Call Forwarding activated, the initial incoming call may be of very short duration. You can set the SMDR feature to record very short, even zero (0) duration calls in order to capture these calls. This, however, may not be desirable, in all systems.

**System Access/
Intercom Buttons**

A Shared SA button cannot be used to turn on Forward or Remote Call Forwarding for the principal's telephone. Calls received on a Shared SA button are not forwarded.

When calls are forwarded to an extension, a call received on an SA or ICOM button rings once at the forwarding extension's SA or ICOM button—including all assigned Shared SA buttons, even though a call received on these buttons is not forwarded—and rings at the destination extension's SA or ICOM button, including all assigned Shared SA buttons, until it is answered. In Release 4.1 and later systems, calls are forwarded immediately when no SA or ICOM button is available at the forwarding extension.

Transfer

Inside and outside calls transferred by another user or by an operator are forwarded. If a user transfers a call to an extension with calls forwarded to an inside extension, the extension receiving the forwarded calls hears one burst of ring, indicating an inside call. If the extension is a display telephone, the call information appears as an inside call and not an outside call. Returning transferred calls are not forwarded.

In Release 6.0 and later systems, all transfers to an extension with Centrex Transfer via Remote Call Forwarding active behave like transfers with automatic completion. Consultation is not permitted. The transfer originator is disconnected, and the call is sent to the outside telephone number.

UDP Features

In Release 6.0 and later systems (Hybrid/PBX mode only), Follow Me is not supported across a private network.

In Release 6.0 (Hybrid/PBX mode only), Forward is not supported across a private network.

In Release 6.1 and later systems (Hybrid/PBX mode only), Forward is supported across a private network.

Consider the following: A BRI call comes in to System A and is forwarded with no Forward Delay over tie lines with E&M signaling to a non-local extension on System B. If the extension on System B does not answer the call within one or two rings, the call is dropped. To solve the problem, set Forward Delay to at least one ring so that System B waits for a ring signal before it disconnects from the call.

Voice Announce

Voice-announced calls are not forwarded.

Group Calling

At a Glance

Users Affected	Telephone users, operators
Reports Affected	Dial Plan Information, Direct Group Calling Information, Extension Information, System Information (SysSet-up)
Modes	All
Telephones	
Supervisor	One of the following assigned as a DLC: MLX-20L MLX-28D MERLIN II System Display Console BIS-34D BIS-22D
Member	All, except QCC
Programming Codes	
Any multiline telephone	
Calls-in-Queue Alarm	*22 + calling group ext. no.
Calling group supervisor	
Unavailable (ES Status 0)	*760
Available (ES Status 2)	*762
Calling group members	*44
Log in/out	
Feature Codes	
Calling group supervisor	
Enter Supervisory Operation	32 + Hold
Exit Supervisory Operation	32 + Drop
Unavailable (ES Status 0)	760 + DSS button
Available (ES Status 2)	762 + DSS button
Calling Group members	
Log In	44
Log Out	*44
MLX Display Labels	
Unavailable (ES Status 0)	ES Status,ES Off [ES,ESOff]
Available (ES Status 2)	ES Status,ES2 [ES,ES2]
System Programming	Assign group members and supervisors to each group: <ul style="list-style-type: none"> ■ Extensions→More→Grp Calling→Members Assign lines/trunks to ring into calling group: <ul style="list-style-type: none"> ■ Extensions→More→Grp Calling→Line/Pool

Assign maximum number of calls allowed in calling group queue (Release 6.0 and later systems):

- Extensions→More→Grp Calling→More→Queue Ctrl→Dial calling group ext. no.→Enter→Dial no. of calls allowed in queue→Enter

Designate calling group as the Support calling group for another (Release 7.0 and later systems):

- Extensions→More→Grp Calling→More→Support→Dial calling group ext. no.→Enter→Dial Support calling group ext. no.→Enter

Assign priority level of calling group (Release 7.0 and later systems):

- Extensions→More→Grp Calling→More→Priority→Dial calling group ext. no.→Enter→Dial calling group priority→Enter

Select hunt type, Circular, Linear, or Most Idle (Release 5.0 and later systems):

- Extensions→More→Grp Calling→Hunt Type→Dial calling group ext. no.→Enter→Circular, Linear, or Most Idle→Enter

Designate delay announcement device. In Release 5.0 and later systems, designate as many as ten primary delay announcement devices and one secondary device, set interval between the first and second announcements, and specify whether second announcement repeats:

- Extensions→More→Grp Calling→DelayAnnce→Dial calling group ext. no.→Enter→Primary Announcement or Secondary Announcement→Enter extension number of announcement device→Enter

Set the delay before the secondary announcement is played and/or repeated:

- Extensions→More→Grp Calling→DelayAnnce→Dial calling group ext. no.→Enter→Secondary Announcement (More needed)

Set the secondary announcement to repeat after the Announcement Interval:

- Extensions→More→Grp Calling→DelayAnnce→Dial calling group ext. no.→Enter→Repeat Announcement→Yes or No→Enter

Calling group as receiver for a Group Coverage sender:

- Extensions→More→Grp Calling→GrpCoverage→Dial calling group ext. no.→Enter→Dial coverage group no.→Enter

Assign message-waiting receiver for calling group:

- Extensions→More→Grp Calling→Message→Dial calling group ext. no.→Enter→Dial ext. no. for MWI receiver→Enter

Select/set overflow basis and/or threshold and designate calling group or QCC queue as overflow receiver:

- Extensions→More→Grp Calling→Overflow→Dial calling group ext no.→Enter→Dial overflow ext. no.→Number Based Overflow, Time Based Overflow, or Prompt Based Overflow (Release 6.0 and later systems)→One of the procedures below:
 - For Number Based: Drop→Dial no. of calls→Enter
 - For Time Based: Drop→Dial no. of seconds→Enter
 - For Prompt Based: Yes or No→Enter

Choose calling group type to determine whether calling group members are automatically logged in after a system restart. When a calling group is used for voice messaging systems, specify whether VMI type is integrated or generic:

- Extensions→More→Grp Calling→Group Type→Dial calling group ext. no.→Enter→Specify login type (Automatic login, Automatic logout, Integrated VMI, or Generic VMI)→Enter

Set calls-in-queue alarm threshold; in Release 5.0 and later systems, specify up to three alarm levels to signal increasing number of callers waiting:

- Extensions→More→Grp Calling→Queue Alarm→Dial calling group ext. no.→Enter→Alarm Threshold 1 or Alarm Threshold 2 or Alarm Threshold 3→Drop→Dial no. of calls (1-99)→Enter

Set the overflow threshold time:

- Extensions→More→Grp Calling→Overflow→Calling Group No.→Time Based Overflow

Assign external alert to notify calling group members of calls-in-queue alarm:

- Extensions→More→Grp Calling→Xtnl Alert→Dial calling group ext. no.→Enter→Drop→Dial ext. no. for alert→Enter

Enter display label for calling group:

- More→Labeling→Grp Calling

Maximums	
Calling groups	32
Extensions for each group	20 local, 1 non-local (Release 6.1 or later systems)
Calling groups for each extension	1
Calling groups for each line/trunk	1
Delay announcement devices for each system	200 can be shared among groups for Release 5.0 and later; in earlier systems, 32
Primary devices per group	10 in Release 5.0 and later; in earlier systems, 1)
Secondary devices per group	1 (Release 5.0 and later)
Message-waiting receivers for each calling group	1 (can be shared among groups)
Calls-in-Queue Alarm threshold levels	3 per group for Release 5.0 and later; in earlier systems, 1
External Alerts for each group	1 (cannot be shared among groups)
Overflow Receivers for each group	1 (can be shared among groups)
Calls in calling group queue	0–99 (setting available in Release 6.0 and later)
Factory Settings	
Calls in Calling Group Queue	99 (setting can be changed in Release 6.0 and later systems only)
Overflow Threshold	
Number-based	1 call (range 1–99 calls)
Time-based	0 (0–900 sec)
Prompt-based	Off; Release 6.0 and later systems
Repeat Secondary Delay Announcement	Off; Release 5.0 and later systems
Time between Announcements	0 (0–900 sec); Release 5.0 and later systems
Calls-in-Queue Alarm Levels:	
Threshold 1	1 call (range 1–99 calls)
Threshold 2	1 call (range 1–99 calls)
Threshold 3	1 call (range 1–99 calls)
Calls-in-Queue Alarm	In Release 4.2 and earlier systems, 1 call (range 1–99 calls)
Calling group priority level	16 (range 1–32); Release 7.0 and later systems
Calling group extension numbers	Release 5.0 and later systems only 770–791, 7920–7929
Extension Status	
Hunt Type	Calling Group/CMS
Group Type	Circular Auto Logout



NOTE:

For additional information about calling group activities, see [“Extension Status” on page 317.](#)

Description

Group Calling is used to direct incoming calls to a specific group of telephones (a *calling group*). A calling group is a team of individuals who answer and handle the same kinds of calls—for example, high-volume work groups such as sales, service, marketing, repair, and technical support. Also, fax machines that receive a large number of fax messages can be placed in a calling group to allow multiple calls to be sent.

Through Group Calling, all members in the calling group are assigned to a single extension number. Specific lines/trunks can be assigned to ring directly into the calling group so that outside callers can dial a published telephone number to reach the group, bypassing the operator.

In Release 6.0 and earlier systems, all members of a calling group must be connected to the same local system. In Release 6.1 and later systems, a calling group may have a *single* non-local member that is defined under the Uniform Dial Plan as existing on another MERLIN LEGEND Communications System connected by a tandem trunk to the local system. A calling group can have a single non-local member or several local extensions. The same calling group cannot have both local members and a non-local member.

A calling group containing a single non-local member can be used for most of the same purposes as a calling group containing only local extensions.

Individual calling group member extensions are assigned an extension number, allowing a group member to receive calls as an individual and as a group member. Outside calls that come into a calling group are usually not intended for a particular group member and can be handled by any member. Inside callers, however, can reach a specific calling group member by dialing the individual extension number assigned to the member.

**NOTE:**

The information in the remainder of the “Group Calling” topic applies primarily to calling groups with local members. Refer to the *Network Reference* for detailed information about calling groups with a single non-local member.

As calls come into the calling group, the system hunts for an available group member in a circular or linear manner, or in Release 5.0 and later systems, according to which member is most idle (see [“*Hunt Type*” on page 359](#)). If a group member is available, the call rings on an SA or ICOM button. If all group members are busy or otherwise unavailable, calls are held in a queue. As calling group members become available, the calls are distributed on a first-in, first-out basis.

When all calling group members are busy, inside callers who are transferred to the calling group hear a regular ringback and the call is sent to the calling group queue; outside callers hear a special ringback or Music-On-Hold if it is programmed for the system. For a summary of what callers hear while waiting in queue or being transferred, see [Table 23 on page 358](#).

In addition, an announcement device can be assigned to the group to play a recorded announcement to each waiting caller, in the order that the calls arrive in the queue. In Release 5.0 and later systems, the system manager can assign up to ten primary and one secondary announcement devices for each group and can specify the delay between announcements, as well as whether the second announcement repeats while a caller waits.

In Release 6.0 and later systems, activating the optional Prompt-Based Overflow setting (factory default is off) allows callers to dial # while listening to a delay announcement. Then the caller is directed to the queue for the overflow receiver. For example, this would allow callers to leave a message with a voice messaging system or with a QCC system operator, rather than waiting in the calling group queue.

NOTES:

- In Release 5.0 and later systems, combining multiple delay announcement devices with tiered alarm thresholds (see [“Overflow Threshold” on page 369](#) for additional details) allows the calling group supervisor or system manager to monitor the effectiveness of delay announcements. See [“Using Alarm Thresholds to Monitor the Effectiveness of Delay Announcements” on page 373](#) for more information.
- In Release 6.0 and later systems, if the Prompt-Based Overflow setting is on, the number of extra touch-tone receivers (TTRs) required for this option is increased. See [“Touch-Tone or Rotary Signaling” on page 716](#).

In Release 7.0 and later systems, a calling group can be assigned as a *Support calling group* for another calling group, called the *Home calling group*. When no Home calling group members are available, members of the Support calling group can answer the Home calling group's calls.

Also in Release 7.0 and later systems, callings groups can be assigned priority levels. This determines whether the Support calling group answers its own calls or the Home calling group's calls first. See [“Calling Group Priority and Support Calling Groups” on page 360](#).

Calling group members log in when they are ready to take calls (called available status) and log out while they finish call-related activities or when they leave their positions (called *unavailable status*). Calls are sent to a calling group member only if the member is logged in and is not busy on another call. When the group

type is set to Auto Logout (the factory setting) and a call sent to a calling group member is not answered within 30 seconds (5 rings), the call is sent to another member or to the front of the queue if another calling group member is not available. The system automatically logs out the extension where the call went unanswered and makes it unavailable for subsequent calls until the calling group member logs in.

A calling group member is considered available if *all* of the following conditions are met:

- The extension is logged into the calling group (available status).
- The extension handset is on hook and a red light is on next to the next line button to be used by Automatic Line Selection; or a headset user is not active on any call, no red light is on at any line buttons, and the speakerphone is off.
- The extension is not ringing or busy on another call.
- The extension does not have a call on hold (except for a call awaiting transfer).
- The extension is not in programming or test mode.
- An SA or ICOM button is available for call delivery.
- Do Not Disturb is off.
- Calls are not being forwarded through Forward, Remote Call Forwarding, or Follow Me.
- The calling group member has not activated Callback to reach a busy line/trunk (Hybrid/PBX mode only) or extension.
- The calling group member is not about to receive a call from a caller who has used Callback to reach the member.

Calling Group Options

This section describes the Group Calling options assigned through system programming and available only for calling groups.

Queue Control

In Release 6.0 and later systems, the system manager can control the maximum number of calls allowed in the primary calling group queue (not an overflow queue) for calls that arrive on certain facilities often assigned to calling groups. The factory setting is 99, but any value from 0 to 99 can be specified as the maximum. When the number of calls in queue reaches the programmed maximum, subsequent eligible callers receive a busy signal.

Queue control applies to the following types of calls:

- DID and dial-in tie trunk calls.
- PRI facilities programmed for dial-plan routing.
- Calls that are transferred from a VMI port.
- Calls transferred on an inside or private network line.



NOTE:

For private network trunks, the call returns only when PRI lines are used and the transfer has been manually completed. Calls transferred to a local calling group or using network PRI lines return to the transfer originator.

- Inside calls to the calling group.
- Inside Dial 0 (#0) and #800 calls delivered to the calling group that is assigned as the QCC Position-Busy backup.
- Private network calls (Release 6.0 or later systems only).



NOTE:

Dial-in tie trunks, including private tandem tie trunks (Release 6.0 and later systems, Hybrid/PBX only) cannot be assigned directly to calling groups.

Queue control does not apply to calls received directly on any of the following facilities:

- Loop-start lines.
- Ground-start lines/trunks.
- Auto-in tie trunks.
- BRI lines.
- T1 facilities emulating ground-start or loop-start lines.
- PRI facilities programmed for line-appearance routings.

In addition, remote-access calls to a calling group, coverage calls directed to a calling group, overflow calls, and outside calls directed to a calling group through QCC Position-Busy backup are not eligible for queue control.

Table 23. Eligibility of Calling Group Calls for Queue Control

Call Type	Eligible	Ineligible
DID trunk (analog or emulated T1)	✓	
PRI		
Dial-plan routed facility	✓	✓
Line-appearance routed facility		
Ground-start line/trunk (analog or emulated T1)		✓
Loop-start line (analog or emulated T1)		✓
Transferred/conferenced from operator or user extension (any extension except VMI port)	✓	
Outside calls transferred from voice messaging system (integrated or generic port)	✓	
Dial 0 and LDN calls directed to a calling group assigned as the QCC Position-Busy Backup	✓	
Auto-in tie trunk		✓
BRI facility		✓
Coverage call		✓
Remote access call		✓
Outside calls delivered to QCC Position Busy backup group		✓
Calling Group Overflow calls		✓

When a call is not eligible for queue control, it is added to the calling group queue, even if that queue has reached or exceeded the programmed maximum number of calls. The Queue Control setting has no effect. For example, if the maximum number of calling group calls is set to 40, and 40 calls have already come in, subsequent callers on eligible facilities hear the busy tone. Calls that arrive on a loop-start line assigned to the calling group, however, are added to the queue.

Calling Group Supervisor Position

The calling group supervisor position is a Direct-Line Console (DLC) with Extension Status assigned through system programming. The calling group supervisor monitors and controls calling group activity by using the LEDs and programmed buttons on the console or DSS.

The supervisor console should include the following programmed buttons:

- For each calling group member, one button programmed with the member's extension on the DLC (inside Auto Dial) or optional DSS.

- A Calls-in-Queue Alarm button (either on the console or on a DSS), programmed with the calling group's extension, for monitoring calls in queue. A supervisor who manages more than one group needs a button for each group.

**NOTE:**

In Release 5.0 and later systems, a DSS button used as a Calls-in-Queue Alarm button only indicates two alarm threshold levels, with either a flash or steady lighting. If DSS buttons are used to monitor calling group queue status, only two alarm thresholds should be set.

- Status buttons for controlling calling group member availability; an Available (ES2) button and an Unavailable (ES0) button. Extension Status features allow a calling group supervisor to change and monitor the status of calling group members (and to enable members to sign in and out of the calling group). See ["Extension Status" on page 317](#) for additional information.

**NOTE:**

In Release 6.0 and later systems (Hybrid/PBX mode only), the calling group supervisor and all calling group members should be located on the same local system.

Hunt Type

The placement of each extension in the hunting sequence used by the system to search for an available calling group member is determined by the order in which each extension is assigned to the group during system programming. When the first call arrives for a calling group after a system is installed or restarted (cold start), the system searches for an available group member, starting with the first extension assigned to the group during system programming.

The order in which the system searches to find available calling group members for subsequent calls can be circular, linear, or according to which agent is most idle, as described below. The order is also called the *hunt type*.

- **Circular.** The system searches for an available calling group member starting with the extension after the last extension to receive a call. The circular order, which is the factory setting, is used when all group members have the same responsibilities for handling calls.
- **Most Idle (Release 5.0 and later systems only).** The system distributes calls according to the most-idle queue. Whenever an agent transfers or hangs up on a call, he or she moves to the end of the queue. For some applications, this hunt type is more efficient than the circular method, because it takes into account the varying duration of calls. Members are

selected based on when they last *completed* a calling group call, not on when they last *received* one. When an agent first logs into a group, he or she is most likely to be the most idle and receive the next call. The Most Idle hunting method ignores non-calling group calls. For example, if an agent transfers a call that arrived on a personal line, the calling group member's most-idle status is unaffected. This setting is also used when all group members have the same responsibilities for handling calls.

**NOTE:**

In a Hybrid/PBX mode system, a calling group member can receive a calling group call at an SA button, then put that call on hold at the SA button. If the agent then picks up the call at a personal line button at his or her telephone, the agent moves to the end of the most-idle queue.

- **Linear.** The system distributes calls starting with the first extension assigned to the group through system programming. Consequently, most calls are handled by the first member assigned to the group. This method is used, for example, when the primary responsibility of the first calling group member is to take calls, while other group members provide backup.

**NOTE:**

For Release 6.1 systems and later (Hybrid/PBX mode only), the hunt type assigned to a calling group that contains a non-local extension has no effect, since this calling group contains only one member.

Calling Group Priority and Support Calling Groups

In Release 7.0 and later systems, a calling group can be assigned a priority level and can be used to support another calling group. When a calling group is assigned as a *Support calling group* to another calling group (called the *Home calling group*), it answers calls coming into the Home calling group when no Home calling group agents are available. Depending on its priority level, the Support calling group answers its own calls or the Home calling group's calls first.

For example, assume that a customer wants his Service group to answer calls for his Sales group before answering calls to the Service group. To accomplish this, the Service group is programmed as a Support calling group for the Sales group, the Home calling group (see [Figure 22](#)). The Sales group is given a higher priority level (1) than the Service group (2), so that the Sales calls will be answered by the Service group before the Service calls are.

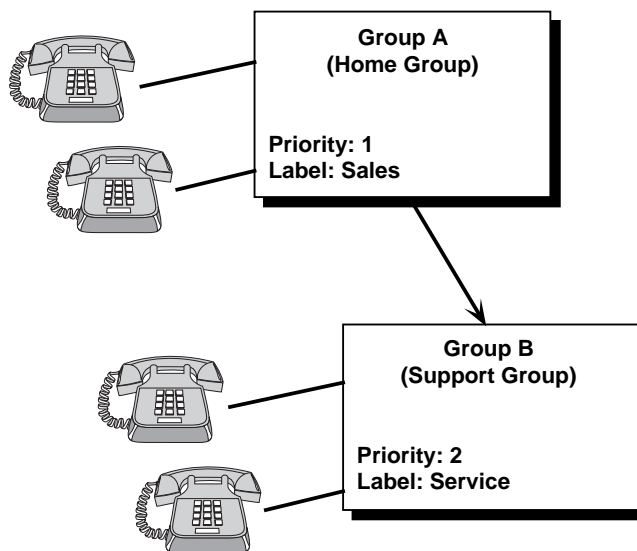

Figure 22. Home Calling Group with a Support Calling Group

As a further extension of the example in [Figure 22](#), two groups can support each other (see [Figure 23](#)). For example, the Service group supports the Sales group, but when the Service group agents are all busy and there are no calls in the Sales group's queue, the Sales group agents can answer Service Group calls. In this scenario, the Sales calls are still the first priority level so the Sales calling group has a higher priority level (1) assigned to it. Each calling group is both a Home calling group and a Support calling group.

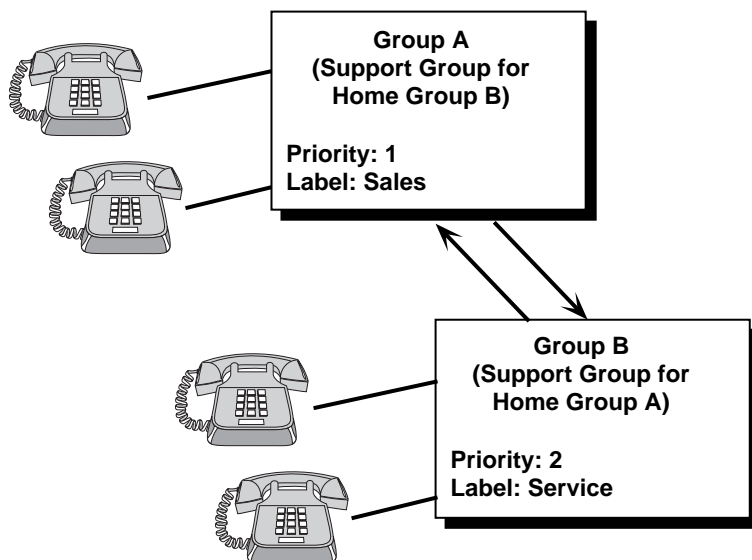

Figure 23. Two Calling Groups Supporting Each Other

[Figure 24](#) shows how one Support calling group can support more than one Home calling group. In this example, three Home calling groups (Sales, Service, and Administration) are all supported by a General calling group. None of the Home calling groups has any agents assigned to it, so calls always are answered by the Support calling group. Each Home calling group has a different priority level, so that the Support calling group can answer the Sales calls first, then the Service calls, and lastly the Administration calls. Each Home calling group's label is sent to the Support calling group agent when a call comes in. In this way, the agent knows how to answer the call (for example, "Hello, this is the Service Department").

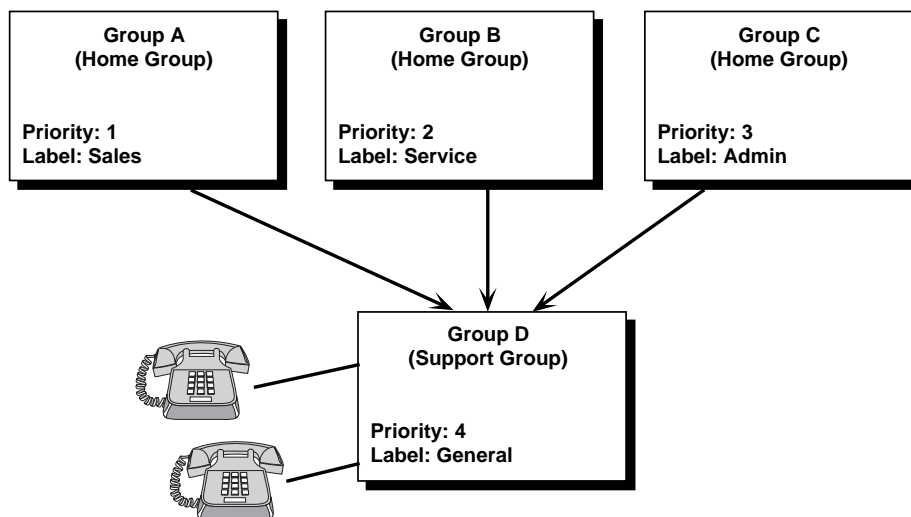

Figure 24. Multiple Home Groups Sharing a Support Group

As [Figure 25](#) shows, a calling group can be a Support calling group and also can be supported by another Support calling group, a sort of hierarchical support. However, Support calling groups can provide only one level of support. Group B supports Group A, and Group C supports Group B, but Group C cannot support Group A.

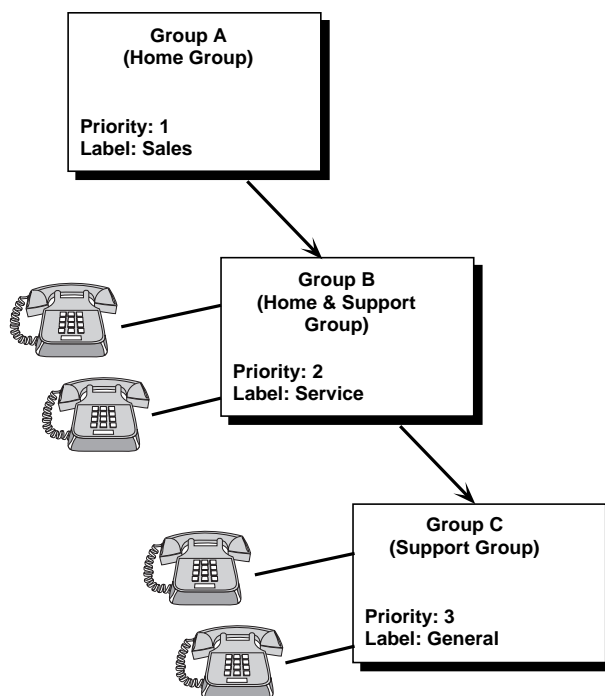

Figure 25. A Support Calling Group with its Own Support Calling Group

Delay Announcements

Delay announcement devices play a message for callers waiting in a calling group queue, explaining the delay to the caller or asking that the caller continue to wait. In Release 5.0 and later systems, each calling group can have up to 10 primary delay announcements and one secondary delay announcement device—a maximum of 11 per group. In earlier systems, a calling group can have only one delay announcement device (no secondary device). The devices can be connected to the control unit on 012 (T/R), 016 (T/R), or 008 OPT modules, or, in Release 7.0 and later systems, on 412 LS-ID-ETR or 016 ETR module ports that have been programmed as tip/ring ports. A delay announcement device can also be connected to an analog multiline telephone through a General Purpose Adapter (GPA) or to an MLX telephone through a Multi-Function Module (MFM). Each device is identified by the extension number assigned in the system numbering plan. Any number of groups can share devices. Delay announcement devices should not be assigned as calling group members.



NOTE:

In Release 6.1 and later systems, no delay announcement device should be assigned for the calling group that contains the single non-local extension, because this calling group member is always available.

When no calling group members are available and calls enter the calling group queue, the announcement device, as it becomes available, answers the call that has been waiting longest and plays the recorded message.

Delay announcement devices may be monitored and logged in and out by the calling group supervisor in the same way that agents are monitored and controlled. After a system cold start or after programming of an extension as a delay announcement, any delay announcement device is automatically logged in. If an available delay announcement device does not answer a voice call within 30 seconds, it is automatically logged out. To reactivate the device, the supervisor or system manager must log in the extension.

In Release 6.0 and later systems (Hybrid/PBX mode only), a delay announcement device must be connected to the same system as the calling group for which it provides announcements.

In Release 5.0 and later systems, the primary delay announcements function like the single announcement available in prior releases. After the delay announcement message plays (the primary delay announcement in Release 5.0 and later systems), an inside caller hears a special ringback, a transferred inside caller hears a regular ringback, and an outside caller (including a transferred outside caller) hears a special ringback or Music-On-Hold, if programmed, until the call is answered by a calling group member. The delay announcement or primary delay announcement is played only once while the call is in queue.

In Release 5.0 and later systems, the system manager can specify the extension for an optional secondary delay announcement and use system programming to set the interval (0–900 seconds) between announcements. This setting determines the time before a waiting caller hears the secondary announcement and, if it is set to repeat, the interval between replays of the secondary announcement. The secondary announcement can either repeat or play only once, after which the caller hears ringback or Music-On-Hold, according to the rules outlined above.

The primary and secondary announcement options, when used together, allow the system manager to issue an initial message to callers, followed by a repeating announcement that, for example, urges the caller to stay on the line and wait for a calling group member. Generally, the interval between delay announcements should be no shorter than the length (in seconds) of the secondary announcement. Ideally, the interval should be the product of the secondary

announcement's length and the anticipated number of calls in queue during a busy time.

**NOTE:**

See [“Using Alarm Thresholds to Monitor the Effectiveness of Delay Announcements” on page 373](#) for information about how tiered alarm thresholds can help determine the effectiveness of delay announcements in Release 5.0 and later systems.

In Release 2.0 and later systems, all calls delivered to a jack programmed as a calling group delay announcement device produce a one-burst inside ring (heard by the caller). In addition, outside calls transferred to a calling group and then answered by either a delay announcement device or a calling group member show the most recent answering extension, not the transferring extension, on the Station Message Detail Recording (SMDR) call record.

If a calling group member becomes available while the caller is listening to a delay announcement, the system immediately routes the caller to the calling group member. The announcement device is then free to handle another queued call.

Each announcement device has an extension number. A calling group member or calling group supervisor, therefore, can dial this number to check or change the announcement as long as the delay announcement device allows a user to read or change messages remotely. If the device is malfunctioning and does not answer the call within 30 seconds (5 rings), the system automatically logs out the device and makes it unavailable for subsequent calls until the calling group supervisor logs in the device or until the next system restart. The only effect on incoming calls is that callers do not hear the announcement.

If a caller hangs up while listening to a delay announcement device, the extension of the delay announcement device, not that of the calling group, is recorded on the SMDR.

In Release 6.0 and later systems, activation of the Prompt-Based Overflow option requires an available touch-tone receiver (TTR) when a delay announcement device assigned to a calling group answers the call. The TTR allows the delay announcement device to receive the caller's entry of #, which sends the call to the overflow calling group. (For details about TTRs required for voice messaging and about TTRs supplied by system line/trunk and extension modules, see [“Voice Messaging Systems” on page 6.](#))

In addition, when the caller is allowed to enter a # to reach an overflow calling group, the system manager must ensure that delay announcement recordings specify this option—for example, “To reach an operator [or to leave a message] rather than waiting for an available agent, press the pound key now.” A brief period of silence should follow the end of the message.

Message-Waiting Receiver

The message-waiting receiver is the extension designated to receive message-waiting indications for the calling group. This includes message-waiting indications sent from an operator, from a display telephone using Leave Message, or from a fax machine. Any type of telephone with a message LED can be assigned as a message-waiting receiver.



NOTE:

In Release 6.0 and later systems (Hybrid/PBX mode only), a remote extension cannot provide message-waiting services for a local calling group.

The extension designated as the message-waiting receiver does not have to be a member of the calling group. Each calling group can have only one extension assigned as its message-waiting receiver; the same extension can be assigned as the message-waiting receiver for more than one calling group.

Message-waiting indications cannot be sent to the extension number assigned to the group unless this option is programmed. The message-waiting receiver cannot distinguish between messages left for the calling group and personal messages.

Calls-in-Queue Alarm Threshold

The Calls-in-Queue Alarm Threshold is the number of calls (1–99) allowed in the queue before calling group supervisors and members are notified that too many calls are waiting for attention. In Release 5.0 and later systems, the system manager can assign three threshold levels to indicate increasing levels of severity, as explained later in this section. When the number of waiting calls is equal to or greater than the programmed Calls-in-Queue Alarm Threshold setting (factory default is one call), the calling group members can be notified in either of two ways:

- Through an external alert connected to an MLX telephone by using a Multi-Function Module (MFM); the MFM is set for Supplemental Alert Adapter (SAA) operation and programmed as the alert. Because the tone sent to the alert is continuous, only a device such as a strobe light, which stays lit until the number of calls drops below the limit, should be used. Only one external alert can be assigned to each calling group, and each external alert can be assigned to only one calling group. An SAA should not be used with an analog multiline telephone, because a steady tone is emitted from the telephone when the visual alert is on.

The system does not block the programming of any extension jack (including extension jacks used for telephones or operator consoles) as an external alert to provide the calls-in-queue alarm. Programming a telephone or console extension as a calls-in-queue alarm, however, is not

recommended, because the telephone alerts continuously with a tone while the number of calls in the calling group queue is equal to or greater than the programmed threshold or in Release 5.0 and later systems, Threshold 3 (see the discussion later in this topic). Single-line telephones do not ring or generate any kind of tone, nor does any device connected to an MFM that is set for tip/ring operation.

- Through the LED associated with a Calls-in-Queue Alarm button (inside Auto Dial button) programmed with the calling group's extension or a DSS button that corresponds to the extension. In Release 5.0 and later systems, the DSS button flashes if the number of calls waiting in the queue is greater than or equal to Threshold 1 but fewer than Threshold 3. The LED lights steadily if the number of waiting calls is greater than or equal to Threshold 3. If three thresholds are needed, an inside Auto Dial button should be used to monitor queue status. There is no limit to the number of buttons that can be programmed to provide the calls-in-queue alarm indication.

Any multiline telephone in the system can be used to monitor the status of a calling group's queue by programming a Calls-in-Queue Alarm button. An MLX display telephone can be used to view the number of calls in a queue (1–99) on the display when the user presses the Inspct button and then presses the Auto Dial button (Calls-in-Queue Alarm button) programmed with the calling group's extension number. The Inspect feature cannot be used on a DSS button.

In Release 5.0 and later systems, three Calls-in-Queue Alarm thresholds can be set to more clearly indicate the real-time status of the queue according to the behavior of programmed Calls-in-Queue Alarm buttons. If all three thresholds are set to the same value, the result is one threshold only with LED states of off and on. If two values are the same, then the result is two alarm levels with LED states of off, flash, and on. The factory setting is one call for all three thresholds. Using all three levels, the system manager sets Threshold 3 to the highest value, Threshold 2 to a middle value, and Threshold 1 to the lowest value. A Calls-in-Queue Alarm button indicates the severity of the alarm conditions in the following ways:

- If the number of waiting calls is fewer than the value programmed for Threshold 1 or drops below that level, the LED is unlit.
- If the number of waiting calls is greater than or equal to the Threshold 1 value but less than the Threshold 2 value, the LED flashes.
- If the number of waiting calls is greater than or equal to the Threshold 2 value but fewer than the value for Threshold 3, the LED winks.
- If the number of waiting calls is greater than or equal to the highest value, Threshold 3, the LED lights steadily.

An external alert only signals when the number of calls in the queue is greater than or equal to the programmed Threshold 3 value.

These thresholds can be used to assess the effectiveness of delay announcements. See [“Using Alarm Thresholds to Monitor the Effectiveness of Delay Announcements” on page 373](#) for details.



NOTE:

In Release 6.0 and later systems (Hybrid/PBX mode only), a Calls-in-Queue Alarm button or alert must be connected to an extension on the same system as the calling group for which it reports.

Overflow Threshold

The overflow threshold is the maximum number of calls waiting in the calling group queue before calls are sent to the overflow receiver. The factory setting is one call.

The Overflow Threshold option should be set to a number larger than the Calls-in-Queue Alarm Threshold, so that the Calls-in-Queue Alarm alerts before calls are sent to the overflow receiver. In Release 5.0 and later systems, the overflow threshold should be greater than the highest Calls-in-Queue alarm threshold (Threshold 3).

The Overflow Threshold option can be used in conjunction with the Overflow Time and Prompt-Based Overflow (Release 6.0 and later systems) options described in the next two sections. Overflow distribution based on the number of calls in the queue or the time spent in the queue takes precedence over calls that go to overflow because of the caller's prompt.

Overflow Threshold Time

In Release 4.0 and later systems, there is also an Overflow Threshold Time setting. The overflow threshold time is the maximum time that any call can remain in the calling group queue before it is sent to the overflow receiver. If the overflow threshold time is set to 0 seconds (factory setting), then the Overflow by Time option is off. If the overflow threshold time is set to any other valid interval (1–900 seconds), then calls that remain in the calling group queue for a time equal to or greater than the overflow threshold time are sent to the overflow receiver.

If you want the Overflow Threshold Time setting to be the primary source for overflow, you should specify an Overflow Threshold setting of a large number of calls (for example, 99 calls). If you want to have overflow by number of calls in the queue, set the overflow threshold time to 0 seconds; this turns off overflow by time.

The Overflow Threshold Time option can be used in conjunction with the Overflow Threshold and Prompt-Based Overflow (Release 6.0 and later systems) options described in the previous and next sections respectively. Overflow distribution

based on the number of calls in the queue or the time spent in the queue takes precedence over calls that go to overflow because of the caller's prompt.

Prompt-Based Overflow

In Release 6.0 and later systems, system managers can activate the Prompt-Based Overflow option. (The factory setting is off.) This option allows callers waiting in queue and listening to a delay announcement to press the # key in order to reach the overflow receiver for the group, which may be the QCC queue or a calling group (including a calling group assigned as a voice mail system).

All three overflow distribution options—based on the number of calls, the time a caller has waited, and the caller's prompt—can be used at one time. In this case, time-based and number-of-calls-based options take precedence over overflow distribution based on the caller's prompt. Calls that exceed these thresholds are handled first.

A caller can be in any queue position when he or she dials # for prompted overflow treatment.

As noted in earlier topics, when prompt-based overflow distribution is used, an extra TTR must be provided. The delay announcement informs the caller of the # key option to leave a message rather than waiting for an agent. If no TTR is available when a calling group call arrives, the call is not sent to a delay announcement extension until a TTR becomes available. For details about planning TTRs, see [“Touch-Tone or Rotary Signaling” on page 716](#) and the section in [“Voice Messaging Systems” on page 6](#).

If, through system programming, the prompt-based option is disabled while callers are waiting in queue, calls are still eligible for the time-based and/or number-based options, as long as the system manager has activated these options.

Overflow Receiver

When the number of calls waiting in the calling group queue reaches the overflow threshold, calls can be sent to an overflow receiver, which can be another calling group or the QCC queue. Only one calling group or the QCC queue can be programmed to provide overflow coverage for the same calling group, and each calling group or the QCC queue can provide overflow coverage for more than one calling group. If no overflow receiver is programmed, the call continues to ring in the queue until it is answered or the caller hangs up.

Calling Group Overflow Receiver

Calls do not go to an overflow receiver that is a calling group until each of the following conditions is met:

- The number of calls in the queue is equal to or greater than the programmed overflow threshold, or the time a call has been in the queue exceeds the overflow threshold time.
- Prompt-based overflow is active, and the caller has entered a # sign while listening to a delay announcement.
- The overflow calling group has an available calling group member.



NOTE:

In Release 6.1 and later systems if the overflow receiver is a calling with a non-local member, the calling group is always available.

- No other calls are already queued for the overflow calling group.

If all conditions are met, the calls are directed to the overflow receiver on a first-in/first-out basis until the number of queued calls in the covered calling group is less than the overflow threshold. The system searches for an available calling group member according to the hunt type assigned to the sending calling group. Calls that overflow to a secondary group cannot overflow again or hear a delay announcement. Once all the number- and time-based calls are handled, prompted overflow calls are handled.

When the overflow group type is set to Auto Logout and an overflow call is not answered within 30 seconds (5 rings), the overflow calling group member is logged out. The call is returned to the sender calling group's queue and is placed at the front of the queue. The caller does not hear the sender's delay announcement, even if the call was sent to the overflow calling group before the caller heard the delay announcement. Also, if time-based overflow is active for the sending group, the call is marked eligible for immediate time-based overflow.

QCC Queue Overflow Receiver

When the QCC queue is assigned to provide overflow coverage for a calling group, the following conditions must be met before calls are directed to the QCC queue:

- The number of calls in the calling group queue is equal to or greater than the programmed overflow threshold, or the time a call has been in the queue exceeds the overflow threshold time.
- Prompt-based overflow is active, and the caller has entered a # sign while listening to a delay announcement.
- At least one QCC does not have Position Busy on.

An overflow call that is sent to the QCC queue does not normally return to the calling group, even if the call is not answered. If all QCCs have Position Busy active, the calls from the calling group do *not* overflow, but continue to wait in the calling group queue. If all QCC operators *activate* Position Busy *while* an overflow call is in the QCC queue, the call can be rerouted to the original calling group.

Calling Group Type

The Group Type setting determines whether or not the system automatically logs in members of a calling group following a power failure. The setting also determines the type of VMI when the calling group is used to connect voice messaging systems or automated attendant applications.

The following settings are available:

- **Auto Logout.** This setting is used to specify that the system does not automatically log in calling group members after a power failure. When the Group Type is set to Auto Logout (the factory setting) and a call sent to a calling group member is not answered within 30 seconds (5 rings), the call is sent either to another member or to the front of the queue, if no calling group member is available.
- **Auto Login.** This setting is for calling groups used for fax machines or data (also called *data hunt groups*) to specify that the system automatically log in calling group members following a power failure. Auto Login can be set for calling groups where members answer telephones.
- **Integrated VMI.** This setting is used when a voice messaging system (such as AUDIX Voice Power, MERLIN LEGEND Mail, or MERLIN Mail) that requires special signaling for integrated operation is connected to one or more extension jacks assigned to a calling group. The system automatically logs in the calling group members after a power failure.
- **Generic VMI.** This setting is used when a voice messaging system (such as Lucent Technologies Attendant or Integrated Voice Power Automated Attendant) that does not require special signaling is connected to one or more extension jacks assigned to a calling group. The system automatically logs in the calling group members after a power failure.

In Release 4.2 and later systems, SMDR can be programmed to provide more detailed information about calls to Auto Login or Auto Logout calling [“Station Message Detail Recording \(SMDR\)” on page 655](#).



NOTES:

- For Release 6.1 systems and later (Hybrid/PBX mode only), a MERLIN LEGEND System directly connected by a PRI tandem trunk or tie trunk to another MERLIN LEGEND System can use the voice messaging system (VMS) of that MERLIN LEGEND System (see [“Centralized Voice Messaging” on page 144](#) for more details). External alerts and

Music-On-Hold sources, however, work only for the system where they reside.

- In Release 6.0 systems (Hybrid/PBX mode only), each networked system should include its own voice mail and/or Auto Attendant applications as well as its own external alerts and Music-On-Hold sources. A single Auto Attendant, however, can transfer calls throughout the network (requires MERLIN LEGEND System Release 6.0, Version 11 or later). It can answer only those calls that arrive on the PSTN facilities of the system where it is connected. For this application, 4-digit pool and line/trunk numbers are recommended. To avoid ambiguity, trunks should be unique—for example, 890 and 8900 should not be used together.
- In Release 6.1 and later systems calls received on PSTN facilities can be answered at a remote system in a private network by assigning the trunks to a calling group with a non-local member.

Using Alarm Thresholds to Monitor the Effectiveness of Delay Announcements

In Release 5.0 and later systems, a system manager or calling group supervisor can use a simple formula to set alarm thresholds in such a way that Calls-in-Queue Alarm buttons can indicate whether or not delay announcements are functioning optimally. Generally, the interval between delay announcements (called the *announcement interval*) should be no shorter than the length (in seconds) of the secondary announcement. Ideally, the announcement interval should be the product of the secondary announcement's length multiplied by the anticipated number of calls in queue during a busy time. For example, if the secondary announcement is 10 seconds long and 5 calls are expected in the queue, the announcement interval should be set to at least 50 seconds.

To set up alarm thresholds, follow these preliminary steps:

1. Set up primary and secondary announcement durations that seem appropriate for your needs.
2. Specify a reasonable announcement interval (for example, 30 seconds based on the rule noted above).
3. Referring to [Table 24](#), divide the announcement interval (Y) by the length of the secondary announcement (Z) and round off this result. This determines the maximum number of calls that can be in the queue before callers have to wait to hear the secondary announcement again.
4. Use the value from Step 3 for any one of the three thresholds. When the number of calls in the queue exceeds this value, the Calls-in-Queue Alarm button signals the overflow.

Table 24. Checking the Effectiveness of Delay Announcements

Calls Waiting for Secondary Announcement (N)	Length of Secondary Announcement in Seconds (Z)	Announcement Interval in Seconds (Y)	Max. # of Calls in Queue before Alarm Signals (Y/Z)	N * Z	N * Z > Y?
3	10	30	3	30	No
3	20	30	2	60	Yes
5	15	90	6	75	No
10	15	90	6	150	Yes

When the number of calls waiting for a secondary announcement multiplied by the length of that announcement is greater than the announcement interval, an alarm is triggered. The table above illustrates situations where a programmed Calls-in-Queue Alarm button would or would not indicate a problem.

If problems arise, use the display at the calling group supervisor DLC console to monitor the situation while the problem is most severe. Try to adjust the secondary announcement's duration and the interval setting so that the announcement interval is greater than or equal to the length of the secondary announcement multiplied by the number of calls waiting for the secondary announcement ($Y \geq N * Z$).

If your calculations indicate a problem, take one or more of the following measures:

- Increase the announcement interval (Y).
- Record a shorter secondary announcement (decrease Z).
- Eliminate the queue for the second announcement in one of the following ways:
 - Increase the number of available agents.
 - Increase the length of the primary announcement.
 - Decrease the number of primary announcements.
 - Set the repeat option for the secondary announcement to off.
 - If the secondary announcement is also serving as the primary announcement, set up a separate primary announcement.
 - If the secondary announcement is shared by more than one group, make it exclusive to the group experiencing the problem.
 - Increase the number of TTRs for Prompt Based Overflow.

Considerations and Constraints

An extension can be a member of only one calling group. Calling groups with no members are allowed.

A calling group cannot contain both local and non-local members. If a calling group has a non-local member, that member must be the only member in the calling group.

Extension Status must be set to calling group/Call Management System (CMS)—the factory setting—and not to hotel configuration.

The Integrated or Generic VMI group type should not be assigned to a calling group used for fax machines.

ETR and MLS telephone extensions cannot be assigned as calling group supervisors.

To allow all calling group members' extensions to ring when an outside call is not answered within three rings, the lines/trunks programmed to ring into the queue can also be assigned to buttons on calling group members' telephones and programmed for Delayed Ring. This does not work for inside calls, remote access calls, and Direct Inward Dial (DID) calls, or when a delay announcement device is assigned to the group.

Lines that are programmed to ring into a calling group also ring at any telephones that have the line assigned to a button. If a call is answered at any one of these telephones, the call is removed from the calling group queue. A line/trunk can be assigned both to a calling group and as a personal line.

A line/trunk cannot be programmed to ring into more than one calling group.

A line/trunk cannot be programmed to ring into both a calling group and a QCC queue.

In Release 6.1 and later systems a line/trunk can be programmed to ring into a calling group with a non-local member. The call is sent over the private network to an extension, calling group, or QCC queue located on a directly connected system.

If no lines are assigned to the calling group, only inside calls or outside calls transferred to the group are eligible for calling group distribution.

The calling group supervisor can log delay announcement devices in or out.

Any of the multiline and single-line telephones compatible with the system can be used as calling group member positions.

The Most Idle hunting method (Release 5.0 and later systems only) ignores non-calling group calls. For example, if an agent transfers a call that was answered on any personal line, the calling group member's most-idle status is unaffected.

In a Hybrid/PBX mode system where the Most Idle hunt type (Release 5.0 and later systems only) is used, a calling group member may receive a calling group call at an SA button, then put that call on hold at the SA button. If the agent then picks up the call at a personal line button at his or her telephone, the system no longer considers the call a calling group call and moves the agent to the end of the most-idle queue.

In Release 6.1 or later systems (Hybrid/PBX mode only), the calling group with the non-local extension is always available.

Labels can be assigned to calling groups to identify the name of the group, such as SALES, SERVICE, or CLAIMS, on display telephones.

Do not use a Supplemental Alert Adapter with an analog multiline telephone, because a steady tone is emitted from the telephone when the visual alert is on.

The system does not prevent users who are not members of a calling group from using the Available (ES2) and Unavailable (ES1) programmed buttons or feature codes. Call Management System (CMS) agents who may not be calling group members can use these same codes to log in and out of the CMS.

The published number for a calling group can be a DID number.

If the Overflow Threshold Time setting for a calling group is changed, the time countdown is reset for any calls waiting in the queue for that calling group.

In Release 2.1 and later systems, a tip/ring port that is programmed as a generic VMI port can transfer an outside call to an outside number (trunk-to-trunk transfer). Release 2.0 and earlier systems can perform a trunk-to-trunk transfer only on ports programmed as integrated VMI.



SECURITY ALERT:

Calling restrictions (for example, Disallowed Lists, Toll Restriction, FRLs) should be programmed, as appropriate, to minimize toll fraud abuse, especially if a single-line telephone is connected to an integrated VMI port. See ["Calling Restrictions" on page 132](#) and [Appendix A, "Customer Support Information,"](#) for additional information about programming calling restrictions.

In Release 3.1 and later systems, ports assigned as Generic VMI or Integrated VMI are assigned a number of security restrictions. Generic VMI and Integrated VMI ports are outward restricted. The factory-set FRL is 0. A default disallowed

list is assigned to the VMI ports; it includes the following entries: 0, 10, 11, 1809, 1700, 1900, 976, 1ppp976, *, (p=any digit).

In Release 4.1 and later systems, changes to Group Calling coverage delays affect the Integrated Administration feature of Integrated Solution III (IS III).

In Release 5.0 and later systems, the three threshold levels, when set, are signaled only at programmed Calls-in-Queue alarm buttons. An external alert lights or sounds only when the number of calls in the queue is greater than or equal to Threshold 3.

Priority Queuing Considerations

Two items must be programmed for Priority Queuing to occur:

- The extension of the Support calling group must be entered.
- The priority level (1–32) of the Support calling group must be entered (factory setting is 16).

A Home calling group can have only one Support calling group. A Support calling group, however, can support up to 31 Home calling groups.

If all Home calling group agents are busy, calls ring at available extensions in the Support calling group.

Calls go to the Home calling group queue only if all the agents in both the Home calling group and the Support calling group are busy.

If a caller to the Home calling group uses Prompt-Based Overflow, the call overflows to the Home calling group's overflow group, not to the Support calling group's overflow.

If calls are in queue for a Home calling group and a Support calling group is programmed, the calls can be processed immediately by the Support calling group.

If the priority level of the Home calling group is changed while calls are in queue, the calls are given the new priority level immediately.

If the Home calling group and the Support calling group have the same priority level, the Support calling group's calls are processed first.

While waiting in queue, the caller hears the delay announcement for the Home calling group, not the one for the Support calling group.

A calling group with a non-local member cannot be programmed as a Support calling group.

When a call is retrieved from the Home calling group's queue by a Support calling group member, the Support calling group display telephone shows the Home calling group's label for the call type.

Mode Differences

Behind Switch Mode

Calls to calling groups in a system set up in Behind Switch mode follow the communications system ring pattern, not the central office ring pattern.

Telephone Differences

Direct-Line Consoles

A DLC can be a member of a calling group; a supervisor position must be a DLC.

Any of the following telephones assigned as a DLC can be used as a calling group supervisor's console:

- MLX-20L telephones with or without a DSS
- MLX-28D telephones with or without a DSS
- BIS-22D
- BIS-34D
- MERLIN II System Display Console with built-in DSS

The supervisor must activate Extension Status to see the status of calling group members and to change their availability; this cannot be done from normal call-handling operation.

To activate Extension Status, the supervisor presses the Feature button, dials 32, and presses the Hold button. To return to normal call handling, the supervisor presses the Feature button, dials 32, and presses the Drop button.

To change the availability of a calling group member, the supervisor activates Extension Status (if not already active) and presses a programmed button for Available (ES2) or Unavailable (ES0) and the Auto Dial or DSS button for the group member's extension number. The supervisor can also change the status of extensions by pressing the Feature button, dialing the feature code [762 for Available (ES2) and 760 for Unavailable (ES0)], and pressing the Auto Dial or DSS button for the group member's extension number. A supervisor with an MLX display telephone can change the status of extensions by pressing the Feature button, selecting the feature from the display (ES2 On for Available and ES Off for

Unavailable), and pressing the Auto Dial or DSS button for the group member's extension number.

Direct Station Selector

In Release 5.0 and later systems, the state of a DSS button used as a Calls-in-Queue alarm button indicates only two alarm threshold levels—either with a flash or steady lighting. For this reason, if DSS buttons are used to monitor calling group queue status, only two alarm thresholds should be set.

Queued Call Consoles

A QCC cannot be a member of a calling group and cannot be assigned as a calling group or CMS supervisor position.

The QCC queue can be designated to provide overflow coverage for calls from one or more calling groups. However, it cannot be designated as a Support calling group. When an overflow call is sent to the QCC queue, it is not identified as a calling group call.

In Release 6.0 and later systems, when a calling group provides Position-Busy backup coverage for a QCC operator, only inside Dial 0 calls from the QCC queue are subject to queue control.



NOTE:

In Release 6.1 and later systems a calling group with a non-local member can be used to send overflow calls over the private network to a QCC queue or to provide Position-Busy Backup or a QCC. See the *Network Reference* for details.

Other Multiline Telephones

Calling group members log into the group by pressing the programmed Available button, or by pressing the Feature button or # and dialing 44. To log out, press the programmed Available button, or press the Feature button or # and dial *44. A confirmation tone is heard.

To see the number of calls waiting in queue, using an MLX display telephone, press the Inspct button followed by the programmed Calls-in-Queue Alarm button. An analog multiline user cannot use the Inspect feature.

Single-Line Telephones

To log into and out of the calling group, lift the handset (which must be connected to an SA or ICOM button) and dial #44 to log in or #*44 to log out. A confirmation tone is heard.

Feature Interactions

Auto Answer All

A calling group member with an analog multiline telephone can use Auto Answer All when an answering machine is connected to the extension. When the feature is activated, all incoming calls ringing on the group member's telephone (both calls for the calling group and calls to the group member's own extension) are answered automatically by the answering machine.

Auto Dial

The Calls-in-Queue Alarm button is assigned on a multiline telephone by programming an inside Auto Dial button with the calling group's extension number.

When a DSS adjunct is not available, Auto Dial buttons programmed with each calling group member's extension are used by the calling group supervisor to monitor group member availability.

Barge-In

Barge-In can be used for calling group members, but the member's extension must be used instead of the calling group extension. If a user tries to use Barge-In after dialing the calling group extension number and waiting in the queue, the feature has no effect.

If a person uses Barge-In to reach another user waiting in a calling group queue, the queued call is removed from the queue and both people are connected. If a person uses Barge-In for the delay announcement extension and the device is playing a message to a caller, the call is removed from the queue and both people are connected.

In Release 5.0 and later systems when the Most Idle agent hunt type is used, if a supervisor or operator barges in on a calling group call and hangs up before the agent does, then Most Idle status is not affected. If the agent hangs up first, he or she moves to the end of the Most Idle queue.

Barge-In cannot be used to join calls to VMI ports.

Callback

Calls made to a calling group are not eligible for Callback because the calls ring into the calling group's queue. Callback, however, can be used for calls to individual calling group member extensions or to the delay announcement device. Calling group calls are not sent to the group member extension, neither when the calling group member uses Callback for a busy extension or pool, nor when another person is using Callback to reach a calling group member and the callback call is ringing on that person's telephone.

In Release 6.1 and later systems when a call is sent to a calling group with a non-local member and no tandem trunks are available, the system automatically provides Callback to queue for an available trunk.

- Caller ID** Caller ID information appears on the display. Outgoing call information is not displayed.
- Calling party number information is sent from one system to another if PRI tandem trunks directly connect the systems. If Caller ID information is received from the PSTN on a loop-start line, the 800 GS/LS-ID, 408 GS/LS-ID-MLX, or 412 LS-ID-ETR LS-ID delay option must be set to On for the information to be sent across the private network.
- If you press the Caller ID name/number toggle button after answering a call, the calling group label is replaced with GrpCl.
- Call Waiting** Calls made to a calling group are not eligible for Call Waiting because the call rings into the calling group's queue. Call Waiting, however, can be used for calls to individual members of the calling group. If the calling group member is a fax machine, the call-waiting tone is not given to the fax jack.
- Camp-On** Users can transfer calls to a calling group by using Camp-On, but calls do not return to the originating extension, even if not answered within the programmed camp-on interval. If the calling group is made up of fax machines, a call-waiting tone is not given to the fax jack when the call is camped-on.
- Centralized Voice Messaging** For Release 6.1 systems and later (Hybrid/PBX mode only), a MERLIN LEGEND System can share the voice messaging system (VMS) of another MERLIN LEGEND System. This sharing of the VMS is called "Centralized Voice Messaging." See the *Network Reference* for more information.
- Conference** Calls waiting in the calling group queue or ringing at a calling group member's extension cannot be added to a conference call. A user must be connected to a calling group member before the call can be added to the conference.
- Coverage** A calling group cannot be programmed as a receiver for Individual Coverage. A coverage group can have only one calling group as a receiver. If a calling group is programmed as a receiver for a coverage group, it must be the only Group Coverage receiver. Coverage (primary and/or secondary) receivers within the calling group, however, can be programmed. A calling group, can be a receiver for as many as 30 coverage groups.
- As soon as the call is sent from the calling group queue to a calling group member or to the delay announcement, the ringing and lit LED are removed from the sender's extension (except for an outside call received on a personal line).

Coverage
(continued)

A calling group cannot be a sender. A calling group *member*, however, can be a sender for Individual Coverage (Primary or Secondary) or Group Coverage. Calls to the calling group extension number are sent only to the calling group member's Individual Coverage receivers and not to the Group Coverage receivers. Calls to the calling group member's individual extension are sent to both Individual and Group Coverage receivers.

Coverage VMS Off can be activated if the user does not want outside calls to be sent to the voice messaging system.

Calls from the system to a VMI port are not sent to Primary, Secondary, or Group coverage.

In Release 6.1 and later systems a calling group with a non-local member can be used to provide group coverage across the private network to a voice messaging system, calling group, QCC queue, DLC, or any individual extension on a remote MERLIN LEGEND, DEFINITY ECS, or DEFINITY Prologic system; or to the PSTN via UDP routing. Refer to the *Network Reference for details*.

In Release 6.0 and later systems, coverage calls directed to a calling group are not subject to queue control.

CTI Link

When an MLX extension is programmed as a CTI link (Release 5.0 and later systems only), it is removed from membership in calling groups.

If a calling group is programmed as the overflow receiver for another calling group, an overflow call can arrive at a personal line button at the extension of the overflow calling group member before it is delivered to any SA button in the overflow calling group.

Digital Data Calls

Lines intended for data calls should not be mixed in the same calling group with lines intended for voice calls.

Video systems can connect using only 1B data connections (providing the video application supports 1B data) when receiving a call through a calling group. A calling group dispenses only one call to each calling group member.

Direct Station Selector

The DSS button's LED for a calling group extension number indicates the status of calls in the calling group queue. In Release 5.0 and later systems, the DSS button flashes if the number of calls waiting in the queue is greater than or equal to Threshold 1, but fewer than Threshold 3. The LED lights steadily if the number of waiting calls is greater than or equal to Threshold 3; otherwise, it flashes. If three thresholds are needed, an inside Auto Dial button should be used to monitor queue status.

In releases prior to 5.0, the LED turns on when calls are at or above the single programmed threshold.

Display	<p>Calling group agents with MLX display telephones see feedback messages on the display when they log into the Available state. When a calling group supervisor with an MLX display telephone logs calling group members in or out, a message appears on the supervisor's display and on the group member's display. After pressing either the programmed Available or Unavailable button or dialing the feature code, supervisors with MLX telephones are prompted to indicate which group member they want to log in or out.</p> <p>Any MLX telephone user can inspect the number of calls in queue by pressing the Inspct button and then pressing a button programmed with the calling group's extension. The display shows the label associated with the calling group and the number of calls.</p>
Do Not Disturb	<p>If a calling group member uses Do Not Disturb, calls are not sent to the group member even if the member is logged in and available.</p>
Extension Status	<p>Extension Status allows calling group supervisors to change and monitor calling group member status, and enables group members to sign in and out of the calling group.</p>
Fax Extension	<p>The calling group receives fax message-waiting indications directed to the calling group. The message-waiting receiver cannot distinguish between messages left for the calling group and fax or personal messages.</p>
Forward and Follow Me	<p>An available calling group member is automatically logged out when she or he forwards calls to an extension or telephone number. If a calling group member logs in while calls are being forwarded, Forward or any type of Remote Call Forwarding is automatically canceled. Calls cannot be forwarded to calling groups.</p> <p>A line/trunk can be assigned as a personal line and ring into a calling group. The principal user of the personal line can use Remote Call Forwarding to forward calls to an outside telephone number. In this case, incoming calls do not ring into the calling group.</p>
Hold	<p>A calling group member who puts a call on hold by using the Hold button is considered unavailable for incoming calls. Inside callers waiting in the calling group queue cannot put themselves on hold.</p>
HotLine	<p>HotLine extensions (Release 5.0 and later systems) can dial a calling group extension number.</p>
Inspect	<p>If you press the Inspct button after answering a call, the calling group label is replaced with GrpCl.</p>
Labeling	<p>An alphanumeric label can be assigned to the calling group. The label is displayed: (i) on incoming calling group calls to MLX or ETR calling group members or (ii) when an MLX display telephone user presses the Inspct button and an Auto Dial button programmed with the calling group's extension number.</p>

- Messaging** Users can leave messages for the calling group only if the system has been programmed with a calling group message-waiting receiver. The receiver also receives fax message-waiting indications directed to the calling group. The message-waiting receiver cannot distinguish between messages left for the calling group and fax or personal messages.
- Multi-Function Module** A Multi-Function Module (MFM) can be a member of a calling group, assigned as a delay announcement for a calling group, or can be used to connect an external alert for a Calls-in-Queue Alarm. An MFM used for the delay announcement or Calls-in-Queue Alert should not be assigned as a group member.
- Music-On-Hold** An outside caller who has been answered and is waiting in the calling group queue hears Music-On-Hold, if programmed.
- Night Service** In Release 2.0 and later systems, a calling group can be a Night Service group member.
- For Release 6.1 systems and later (Hybrid/PBX mode only), a calling group receiving Night Service calls can contain a non-local extension as its only member.
- Park** A calling group member who parks a call is considered available to receive another call.
- Personal Lines** If a person uses a shared personal line button to join a call in the calling group queue, the call is removed from the queue. If a delay announcement is playing, it is disconnected from the call.
- To allow all calling group members' telephones to ring when an outside call is not answered within three rings, the lines/trunks programmed to ring into the queue can also be assigned as personal lines on group member telephones and programmed for Delay Ring. This does not work for inside calls, remote access calls, DID calls, or when a delay announcement device is assigned to the group.
- In a Hybrid/PBX mode system where the Most Idle hunt type (Release 5.0 and later systems) is used, a calling group member may receive a calling group call at an SA button, then put that call on hold at the SA button. If the agent then picks up the call at a personal line button at his or her telephone, the system no longer considers the call a calling group call. The agent, therefore, moves to the end of the most-idle queue (Release 5.0 and later systems) and can receive another calling group call immediately.
- Pickup** A calling group member can also be a member of a Pickup group. Calling group members can use Pickup to answer a call (either a calling group or individual group member extension) that is ringing at another group member's telephone. Line Pickup can be used to pick up a call that is in the calling group queue. Picking up a call on hold moves a calling group agent to the end of the most-idle queue (Release 5.0 and later systems).

- Pools** Lines/trunks assigned to pools can be assigned to ring into a calling group. An incoming call on a line/trunk assigned to the pool rings on an SA button, even if the calling group member has a Pool button assigned to his or her telephone.
- Primary Rate Interface and T1** A PRI line that is a member of a B-channel group programmed for routing by dial plan should not belong to a calling group. A line that is part of a B-channel group included in a calling group should not be programmed for routing by dial plan.
- Recall/Timed Flash** A user who has received an inside calling group call can use Recall.
- Remote Access** Remote access users cannot log into a calling group, but they can call into a calling group regardless of the restrictions applied. When the call rings at a calling group member's telephone, it rings as an outside call.
- A calling group can be programmed to receive calls from remote access users to invalid extensions. If a line/trunk is programmed for both remote access and Group Calling, remote access overrides Group Calling.
- In Release 6.0 and later systems, remote access calls to a calling group are not subject to queue control.
- Ringng Options** Abbreviated ringing is not operable for calls to a calling group extension, because a calling group member active on a call is considered unavailable for incoming calls. In Hybrid/PBX mode, calling group members should program SA buttons for Immediate Ring.
- Service Observng** In Release 6.1 and later systems a calling group member who answers a call can be observed as long as the calling group is not a voice messaging interface (VMI) calling group. A call coming into a VMI calling group cannot be observed.
- If a delay announcement device answers a call, the call cannot be observed while it is at the delay announcement device. If a fax extension has answered a call, the call cannot be observed while it is at the fax extension.
- If a Service Observer is a member of a calling group and is observing a call, he or she is considered busy for Group Calling.
- Signal/Notify** A Signaling button cannot be programmed for a calling group.
- SMDR** Calls to calling groups are associated with the first extension that handles the call. If the call is answered by the calling group delay announcement device, the extension for the delay announcement device is recorded on the SMDR record, even if the call is later answered by a calling group member or overflow group member.

SMDR
(continued)

In Release 4.2 and later systems, the programmable SMDR TALK field (factory setting is off) records the time agents spend talking to incoming callers; the agents' calling groups must be assigned the Auto Login or Auto Logout group type. Calls answered by a delay announcement device, calling group overflow receiver, or QCC queue overflow receiver are reported with blank TALK entries.

Release 4.2 and later systems supply the following additional information about incoming calls to Auto Login or Auto Logout calling groups, provided the SMDR Talk Time option is enabled:

- If a call goes to an overflow receiver, SMDR marks the CALL TAG field with an ampersand (&).
- If a call is answered at a non-calling group extension, SMDR puts an exclamation point (!) in the CALL TAG field.

In Release 4.2 and later systems, timing for incoming calls to Auto Login or Auto Logout calling groups begins when a call arrives at the system. If the caller hangs up while listening to a delay announcement, the call is associated with the extension of the device.

In Release 4.1 and prior systems, timing begins as soon as the calling group member or delay announcement device answers the call.

**System Access/
Intercom Buttons**

Calls to a calling group ring on SA or ICOM buttons on the telephones of calling group members. A calling group member who is making or receiving a call on a Shared SA button is considered unavailable by the system; the principal owner, however, is considered available and can still receive calls directed to the calling group.

**System
Renumbering**

Extensions for calling groups are factory-assigned and can be renumbered through system renumbering. (The factory settings are 770–791 and 7920–7929.)

Transfer

A call transferred to a calling group is not returned to the originator but is handled as any other call received in the calling group. For example, the system follows the same hunt sequence to locate an available calling group member, and the call is eligible for a delay announcement if one is programmed. A calling group member who has a call on hold for transfer is considered available for a call because transfer hold requires pressing the Transfer button rather than the Hold button.

Voice-announced transfers cannot be made to a calling group.

There is no limit to the number of calls that can be transferred to a calling group. When an agent transfers a call, the system moves his or her extension to the end of the most-idle queue (Release 5.0 and later systems).

In Release 2.0 and later systems, when an inside caller is transferred to a calling group and no members are available, the inside caller hears a one-burst ringback. When an outside caller is transferred to a calling group and no members are available, the outside caller hears a two-burst ringback or Music-On-Hold, if programmed.

Calls transferred by a voice messaging system to an invalid extension, or calls that are not answered and are programmed to be sent to a calling group, are delivered to an available member of a calling group as a non-calling group call. If the member does not answer the call, the call is not queued, is not delivered to a delay announcement unit, and does not overflow. Instead the system tries later to deliver the call. In Release 6.1 systems and later, these calls may be delivered to a calling group with a non-local member.

UDP Features

Private-networked trunks cannot be programmed to ring into calling groups, because tandem trunks are dial-in facilities.

When a calling group extension number is included in the non-local dial plan, you can dial the group just as you would any other extension. Calls can be transferred to non-local calling groups.

In Release 6.0 systems (Hybrid/PBX mode only), all calling group members, the supervisor, alerts, delay announcement devices, and overflow receivers must be located on the same system.

In Release 6.1 and later systems (Hybrid/PBX mode only), coverage and overflow can be directed to a calling group that contains a single non-local extension number.

Calls-in-Queue Alarm buttons and alerts as well as delay announcement devices work only for calling groups on the local system.

Headset Options

At a Glance

Users Affected	Telephone users, operators
Reports Affected	Extension Information
Modes	All
Telephones	MLX telephones
Programming Codes	
Headset Hang Up	*781 (centralized telephone programming only; not applicable for QCC)
Headset Status	*782
Headset Auto Answer	*780
Headset/Handset Mute	*783
MLX Display Labels	
Headset Hang Up	Hdset , Hang Up
Headset Status	Hdset , Status [Hdset , Stat]
Headset Auto Answer	Hdset , Auto Answer [Hdset , Auto]
Headset/Handset Mute	Hdset , mute [Hdset , Mute]

Description

Four headset options are provided for MLX telephone users and operators who have an optional headset adjunct:

- Headset Hang Up (except for QCC)
- Headset Status
- Headset Auto Answer
- Headset/Handset Mute

Headset Hang Up

When programmed on a button on an MLX telephone or MLX Direct-Line Console (DLC), Headset Hang Up serves two purposes:

- If an extension does not have a Headset Status button, pressing a Headset Hang Up button automatically turns on headset operation for that extension, so that the user or operator can answer and make calls using the headset instead of the handset. Removing the Headset Hang Up button automatically turns off headset operation for that extension.

- The user or operator presses the Headset Hang Up button to disconnect a headset call. The button replaces switchhook operation, which is disabled when headset operation is active.

For a user or operator to be able to use a headset, a Headset Hang Up button must be programmed (centralized telephone programming) for an MLX telephone or MLX DLC.

Headset users should press the programmed Headset Hangup button after each call. In Release 6.1 and earlier systems, if the user does not press the Headset Hangup button, new calls still arrive correctly, but the LED status of the extension (as shown on other extensions and DSSs) is not updated. In Release 7.0 and later systems, if the caller hangs up and a reliable disconnect is received by the system, the user does not have to press the Headset Hangup button, and the LEDs are automatically updated.

A Headset Hang Up button is not needed (and cannot be programmed) on a QCC.

To give control of headset/handset operation to an MLX telephone user or MLX DLC operator who has a Headset Hang Up button, a Headset Status button can also be programmed, as described in the next section. On a telephone or console with a Headset Hang Up button but without a Headset Status button, headset operation is always on.

**NOTE:**

If an MLX telephone or MLX DLC has a Headset Status button and/or a Headset Auto Answer button in addition to a Headset Hang Up button, the Headset Hang Up button can be removed through centralized programming without removing the Headset Status or Headset Auto Answer button. If either of these features is on, the green LED next to the button stays on. The telephone or console, however, is no longer in headset operation; neither the Headset Status nor the Headset Auto Answer button has any effect, whether on or off, until a Headset Hang Up button is reprogrammed for the extension.

Headset Status

When a Headset Hang Up button is programmed on an MLX telephone or MLX DLC, headset operation is automatically turned on. Programming a Headset Status button also allows the user or operator to turn headset operation off and on manually. With headset operation on (green LED next to Headset Status button is on), the user or operator answers and makes calls with the headset. With headset operation off (green LED next to Headset Status button is off), the user or operator answers and makes calls with the handset.

Two conditions are necessary for an MLX telephone user or MLX DLC operator to use the Headset Status feature:

- A Headset Hang Up button must be programmed, as described in the previous section.
- A Headset Status button must be programmed on the telephone or console, through either extension programming or centralized telephone programming.

A Headset Status button is a fixed feature on a QCC and cannot be deleted or changed.

To use Headset Auto Answer, Headset/Handset Mute, or Headset Hang Up on a telephone or console with a Headset Status button, Headset Status must be on.

When Headset Status is on, switchhook operation is disabled. The handset or speakerphone can be used to make or answer a call, but the only way for the user or operator to disconnect from a call is by pressing the Headset Hang Up button. The user or operator can turn off the headset and switch back to switchhook operation by pressing the Headset Status button; the green LED next to the button turns off.

Headset Auto Answer

A Headset Auto Answer button allows an MLX telephone user or operator with a headset to be connected automatically to a ringing call. Headset Status must be on, as described in the two previous sections, before Headset Auto Answer can be used.

When Headset Auto Answer is turned on, the green LED next to Headset Auto Answer button is on, and the user or operator hears a zip tone through the headset to indicate an incoming call. Following the tone is a brief pause, during which the microphone is temporarily disabled to prevent the user's or operator's private conversation from being heard by the caller.

When Headset Auto Answer is on and the user presses the Headset Auto Answer button with a ringing call (for example, when Ringing/Idle Line Preference is turned off), the call is answered without the user hearing zip tone.

Headset Auto Answer can be turned on and off during a call without disconnecting the caller. The turning on or off takes effect immediately.

Headset Auto Answer does not automatically answer voice-announced calls. When the user or operator is on a call, Headset Auto Answer is turned off; calls are not answered automatically until the caller hangs up or the user or operator presses the Headset Hang Up button to disconnect the call.

When the user or operator has a call on hold or is in the process of transferring a call or setting up a conference, Headset Auto Answer is also turned off. If the user or operator pressed the Conf, Hold, Direct Voice Mail (to transfer to voice mail), or Transfer button, he or she must press the Headset Auto Answer button to turn the feature back on before another call can be answered automatically.

Two buttons are necessary for an MLX telephone user or MLX DLC operator to use the Headset Auto Answer feature:

- A Headset Hang Up button must be programmed, as described earlier.
- A Headset Auto Answer button must be programmed on the telephone or console, through either extension programming or centralized telephone programming.

Users who have extensions programmed for Headset Auto Answer may also receive Caller ID information provided by a loop-start line connected to an 800 GS/LS-ID, 408 GS/LS-ID-MLX, or 412 LS-ID-ETR module. They should set the LS-ID Delay to Yes (Release 3.0 and later systems).

A Headset Auto Answer button is a fixed feature on a QCC and cannot be deleted or changed.

Headset/Handset Mute

Headset/Handset Mute allows an MLX telephone user or operator to turn the microphone in the headset or handset off and on. The user or operator can then talk privately with another person in the same room without the caller hearing the conversation. If headset operation is on, Headset/Handset Mute turns off the headset microphone; if headset operation is off, Headset/Handset Mute turns off the handset microphone. The red LED next to the Headset/Handset Mute button is on when the headset or handset microphone is off; it is off when the headset or handset microphone is on.

When headset operation is off, the handset microphone can be turned off using Headset/Handset Mute only when the user lifts the handset.

A Headset/Handset Mute button is a fixed feature on a QCC and cannot be deleted or changed.

Considerations and Constraints

The headset, handset, and speakerphone can be used only one at a time.

Headset Hang Up cannot be programmed on a QCC.

Headset options cannot be used on analog multiline telephones or on single-line telephones.

A headset user must manually select a line button (or Call button on the QCC) before making an inside or outside call.

A user can press the Speaker button to move the call from the headset to the speakerphone.

Privacy should be programmed when headset users with Headset Auto Answer turned on either have Shared SA buttons or share one or more personal lines. Privacy keeps people from competing for the same call. When two or more users answer the same call on an SSA or personal line button, the red and green LEDs next to the button go on, but only one person can talk with the caller.

Headset users should press the programmed Headset Hangup button after each call. In Release 6.1 and earlier systems, if the user does not press the Headset Hangup button, new calls still arrive correctly, but the LED status of the extension (as shown on other extensions and DSSs) is not updated. In Release 7.0 and later systems, if the caller hangs up and a reliable disconnect is received by the system, the user does not have to press the Headset Hangup button, and the LEDs are automatically updated.

Telephone Differences

Queued Call Consoles

A QCC does not have a Headset Hang Up button, nor can the button be programmed. Headset operation is automatically available, and Headset Auto Answer, Headset/Handset Mute, and Headset Status are fixed buttons on a QCC.

The function of disconnecting calls served by the Headset Hang Up feature is replaced by the Release, Forced Release, Camp-On, and Automatic Release features on the QCC.

Other Multiline Telephones

Headset options apply to MLX telephones and consoles only.

A telephone user or operator cannot use feature codes or extension programming to activate Headset Hang Up. This feature must be programmed on a button through centralized telephone programming.

A telephone user or operator cannot use feature codes to turn Headset Auto Answer, Headset/Handset Mute, or Headset Status on or off. These features must be programmed on buttons through either extension programming or centralized telephone programming. MLX display telephone users can select the feature from the display only during extension programming.

Headset operation on ETR and MLS telephones works the same as without the headset. For example, to make a call while using the headset, you must manually remove the receiver from its cradle to go off-hook. To hang up the headset, you must place the receiver back in the cradle.

Feature Interactions

Authorization Code	If a call is made using an authorization code, pressing the Headset Hang Up button causes deactivation of the Authorization Code feature.
Auto Dial	If headset operation is turned on at the telephone or console, select a line button before dialing an extension or an outside number using Auto Dial.
Automatic Line Selection	Automatic Line Selection does not work when an MLX telephone or console is in headset operation. A headset user must select a line manually before making a call.
Barge-In	If Barge-In is used to contact a user with Headset Auto Answer turned on, the call is answered automatically.
Callback	Callback calls are answered automatically when Headset Auto Answer is turned on, but the user hears the dequeuing tone instead of a zip tone. When both caller and receiver have headsets with Headset Auto Answer on, the person being called hears a zip tone when the callback call is completed, but the callback originator does not hear a zip tone or dequeuing tone.
Caller ID	When using Headset Auto Answer on an extension, the intercom and line buttons should be programmed for Delay Ring so that the Caller ID information, available after the first ring, is not lost.
Conference	Headset Auto Answer is turned off automatically while the user sets up a conference and must be turned back on manually.
Direct Station Selector	In Release 7.0 and later systems, when the headset user receives a Voice Announce call, the DSS LED for the user lights. The DSS LED remains lit when the call is switched from the speaker to the headset. When the calling party hangs up, or the headset user presses the Headset Hang-Up button, the DSS LED for the headset user turns off.
Direct Voice Mail	When an MLX telephone user (except a QCC operator) transfers a call using Direct Voice Mail, Headset Auto Answer is turned off and must be turned back on manually.
Do Not Disturb	If an MLX telephone user with Headset Auto Answer turned on uses Do Not Disturb, any calls that override Do Not Disturb (such as Barge-In calls and callback calls) are answered automatically.
Hold	Headset Auto Answer is turned off automatically when a user or operator puts a call on hold and must be turned back on manually.
Paging	A user or operator with a headset operation active hears a group page over the speakerphone.

- Park** If a user or operator has a call parked, another call can be answered automatically by using Headset Auto Answer.
- Privacy** Privacy should be programmed when headset users with Headset Auto Answer on have Shared SA buttons, or they share one or more personal lines. Privacy keeps the users from competing for the same call. When two or more users answer the same call on a Shared SA or personal line button, the red and green LEDs next to the button go on, but only one person can talk with the caller.
- Ringling Options** If abbreviated ringling is not programmed, the user hears a low-volume ring if another call comes in while he or she is already on a call.
- Ringling/Idle Line Preference** Ringling Line Preference does not operate if Headset Auto Answer is turned off while headset operation is active. To answer a call, the user presses the button with the ringling call. Idle Line Preference does not operate when headset operation is active. The user selects a line button manually before making an inside or outside call.
- Service Observing** In Release 6.1 and later systems a Service Observer with a headset can be a Service Observer and a member of a Service Observing group.
- An extension answering a call by using Headset Auto Answer can be observed. If the Service Observer has Headset Auto Answer off and a call comes in to the extension being observed, the Service Observer does not hear a zip tone but can automatically listen in on the call with the headset. A zip tone is heard in the headset when the Service Observer receives a normal call.
- If an observed extension uses Headset Hang-up to disconnect a call, the observer is dropped from the call. An observing station can use this feature to end observation of a call.
- If an observed extension uses the Headset/Handset Mute feature, the Service Observer does not hear the person on that extension but can hear the other parties on the call. If the Service Observer uses the Headset/Handset Mute feature, the observed extension is not aware of it.
- If a Service Observer is using a headset and the headset status button is on, the Service Observer must first press an SA button before pressing the Service Observing button to begin an observing session.
- Transfer** When an MLX telephone user (except a QCC operator) transfers a call, Headset Auto Answer is turned off and must be turned back on manually.

Hold

At a Glance

Users Affected	Telephone users, operators
Reports Affected	Operator Information, System Information (SysSet-up)
Modes	All
Telephones	All
Feature Codes	
Hold	771
Hold Release	**
System Programming	<p>Change hold disconnect interval:</p> <ul style="list-style-type: none"> ■ LinesTrunks→More→HoldDiscnct <p>Enable or disable DLC operator automatic Hold for all DLC operators:</p> <ul style="list-style-type: none"> ■ Operator→DLC Hold <p>Change operator hold timer for all DLC and QCC operators:</p> <ul style="list-style-type: none"> ■ Operator→Hold Timer <p>Specify whether calls on hold return to QCC queue after operator hold timer has expired twice:</p> <ul style="list-style-type: none"> ■ Operator→Queued Call→Hold Rtrn <p>Select automatic Hold or automatic release for all QCC operators:</p> <ul style="list-style-type: none"> ■ Operator→Queued Call→HoldRelease
Factory Settings	
Hold Disconnect Interval	Long (450 ms)
DLC Operator Automatic Hold	Disabled
Operator Hold Timer	60 sec (range 10–255 sec)
Hold Timer for Users	60 sec (fixed)
QCC Hold Return	Remain on Hold
QCC Hold Release	Automatic Release

Description

Hold allows a user to leave a call temporarily in order to perform some other function, such as taking another call, looking up information, or activating a feature.

When a user, except a QCC operator, puts an outside call on hold, the green LED next to the line button flashes at a faster rate to distinguish the call from calls put on hold by other users.

An outside caller on hold hears Music-On-Hold, if programmed, or silence. If a call on hold is not picked up within a set length of time, the person who put the call on hold hears a reminder: a beep for a telephone user, an abbreviated ring for a system operator. This hold timer is fixed at 60 seconds for telephone users. It is programmable for DLC and QCC operators, as described below.

At an MLX display telephone, the message `Call On Hold` appears briefly on the display when the user first puts a call on hold. This message reappears briefly each time the hold timer expires.

Five systemwide Hold options can be set through system programming:

- **Hold Disconnect Interval.** Determines how long the system waits before releasing the line when an outside caller on hold on a loop-start line hangs up. The hold disconnect interval should be programmed to match the local telephone company's disconnect timing: Long if disconnect is unreliable, and Short if disconnect is reliable. The hold disconnect interval applies to all telephone users and system operators. This interval can be set to the following values:
 - Long (the factory-set value): 450 ms
 - Short: 50 ms
- **DLC Operator Automatic Hold.** Determines what happens when a DLC operator is on a call and presses another line button, an Auto Dial button, or a Direct Station Selector (DSS) button. The DLC Operator Automatic Hold setting applies only to DLC operators. This option can be set to the following values:
 - **Enabled.** The active call is automatically put on hold. This prevents accidental disconnection of callers.
 - **Disabled** (factory-set time). The active call is disconnected. This allows an operator to disconnect one call and answer or dial another by pressing a single button.
- **Operator Hold Timer.** Determines how long a call stays on hold before the system reminds the DLC or QCC operator that it has not been picked up. The operator hold timer applies only to DLC and QCC operators. The operator hears a reminder (abbreviated ring) when the timer expires. This timer can be set to a value between 10 and 255 seconds. (The factory-set value is 60 seconds.)

If a call is ringing at the console when the timer expires, the reminder is delayed for 10 seconds so that the operator has a chance to hear it. (If after 10 seconds the call is still ringing or a new call is ringing, the reminder is delayed for another 10 seconds, and so on.)

- **QCC Hold Return.** Determines what happens to a call that a QCC operator has put on hold and that has not been picked up after the operator hold timer has expired twice. (The timer is not counted as having expired until the operator actually hears the reminder.) The QCC Hold Return option applies only to QCC operators. This option can be set to the following values:
 - **Remain on Hold** (factory setting). The call remains on hold until picked up. A QCC operator continues to hear an abbreviated ring every time the operator hold timer expires.
 - **Return to Queue.** The call returns to the QCC queue. The caller hears ringback.
- **QCC Hold Release.** Determines what happens when a QCC operator is on a call and presses another Call button. The Hold Release option applies only to QCC operators. This option (equivalent to DLC operator automatic Hold for DLC operators) can be set to the following values:
 - **Automatic Hold.** The active call is put on hold. This prevents accidental disconnection of callers.
 - **Automatic Release** (factory setting). The active call is released. This allows an operator to disconnect one call and answer another by pressing a single button.

Considerations and Constraints

The factory setting for the hold disconnect interval is Long (450 ms) because that is the interval used by most local telephone companies.

If the hold disconnect interval set for the system does not match that of the local telephone company, the system may have the following problems with calls on hold:

- If the interval is shorter than the setting at the local central office, callers on hold may be disconnected.
- If the interval is longer than the setting at the central office, the LED next to the line button continues to flash after a caller on hold hangs up.

Both parties on an inside call cannot put each other on hold. If a user presses the Hold button while waiting on hold on an inside call, the call is disconnected.

Telephone Differences

Direct-Line Consoles

When DLC operator automatic Hold is enabled, the DLC operator can put an active call on hold by pressing another line button or DSS button. How Hold works depends on the type of call and its appearance on the telephone:

- When one-touch Hold is programmed systemwide and the operator is active on a Personal Line, pressing an Auto Dial button or DSS button also puts the call on hold. This prevents accidental disconnection of callers and speeds call handling. If the operator is active on an inside call and the call is on hold, the DLC operator hears an abbreviated ring as a reminder each time the interval programmed for the operator hold timer (10–255 seconds) expires.
- If the operator is active on an inside or outside call on an SA button, pressing an Auto dial button or a DSS button does not place the call on hold. The user at the extension associated with the Auto Dial or DSS button hears the manual signaling beep.
- For Release 6.1 and later systems (Hybrid/PBX mode only), if, while on an inside or outside call on an SA button with one-touch Hold enabled, a DLC operator presses a DSS button for a non-local extension, the call is not placed on hold, and the extension is not dialed. If, however, while on an outside call on a Personal Line button with one-touch Hold enabled, a DLC operator presses a DSS button for a non-local extension, the call is placed on hold and the non-local extension is dialed

If the system is programmed for one-touch Transfer, an operator can press an Auto Dial or DSS button to put an active inside or outside call on hold and initiate a transfer, whether or not DLC operator automatic Hold is enabled.

If the system is not programmed for one-touch Transfer, an operator can press an Auto Dial or DSS button to put an active *outside* call on hold and initiate a transfer, whether or not DLC operator automatic Hold is enabled. (This capability is called *one-touch Hold*.)

Every time the operator hold timer expires, the DLC operator hears an abbreviated ring as a reminder that a call is on hold.

Queued Call Consoles

Pressing the Hold button to put a caller on hold makes a QCC operator available for incoming calls from the QCC queue.

The first two times the operator hold timer expires, a QCC operator hears an abbreviated ring as a reminder that a call is on hold.

If an operator does not pick up a call by the time the timer expires twice, the Hold Return option determines whether the call remains on hold or returns to the QCC queue. If this option is programmed for calls to remain on hold, an operator hears the abbreviated ring every time the operator hold timer expires and no call is ringing on the console. If the option is programmed for calls to return to the queue, each call on hold at the QCC is timed individually. (The operator hold timer is applied separately to each Call button.)

When a held call returns to the queue after the second hold reminder, the call is identified by call type and by the name and extension number of the operator who put it on hold. The second line of the QCC display also shows the caller information.

Other Multiline Telephones

Multiline telephones have built-in Hold buttons.

When a call is first put on hold, the display on an MLX telephone briefly shows `Call on Hold`. This message reappears briefly each time the hold timer expires.

Single-Line Telephones

In Release 4.0 or later systems, single-line telephone users must use Park instead of Hold to put a call on hold. If a single-line telephone user with a call on hold hangs up, the call is dropped.

A single-line telephone user can put a call on hold by sending a switchhook flash: pressing and releasing the Recall or Flash button or the switchhook, depending on the telephone model. If a single-line telephone user with a call on hold hangs up, the call rings back at the extension.



NOTE:

Some single-line telephones, such as Lucent Technologies models 2500YMGL, 2500MMGK, and 8110M, use a timed or positive disconnect. On these telephones, pressing the switchhook disconnects the call. Use the Recall or Flash button instead of the switchhook to send a switchhook flash. (The 8100M telephone must have positive disconnect programmed on the telephone, as described in its manual.)

Feature Interactions

Allowed/Disallowed Lists	The Hold button is used to enter a wild card character in an Allowed or Disallowed List entry.
Authorization Code	Initiating the Hold feature after entering an authorization code deactivates the Authorization Code feature for subsequent calls.
Auto Dial	The Hold button is used to enter the Pause special character in a telephone number programmed on an Auto Dial button.
Basic Rate Interface	An active call on a BRI line can be placed on hold. All call appearances (such as LEDs) are the same as for other non-BRI lines.
Callback	Pressing the Hold button while waiting for a queued call is similar to hanging up. The green LED flashes next to the line button, indicating that the button is being used for the queued call.
Call Waiting	A person with all calls on hold cannot hear the call-waiting tone.
Conference	<p>When adding other participants to a conference, the conference originator hears the hold reminder when the conference is on hold for longer than one minute (if the originator is a telephone user) or for longer than the operator hold timer setting (if the originator is an operator).</p> <p>If DLC operator automatic Hold is programmed and used by a DLC operator while setting up a conference, the entire conference goes on hold.</p> <p>Both parties on an inside call cannot put each other on hold. If a user presses the Hold button while waiting on hold for a conference initiated by another user (an inside call) or if the user presses the Conf button while waiting on hold on an inside call, the entire conference call is disconnected.</p> <p>The initiator of a conference call can leave the conference by pressing Hold. The conference initiator can rejoin the conference call by pressing the line button of any conference participant.</p> <p>In Release 2.1 and later systems, a call that has been put on hold on a Cover button can be added to a conference by a user who has a personal line for the call.</p>
Coverage	<p>Coverage calls answered by any type of receiver can be put on hold. The hold timer or operator hold timer applies to a coverage call on hold.</p> <p>In Release 2.1 and later systems, a call that has been put on hold on a Cover button can be picked up by a user who has a personal line for the call. When the call is picked up, the green LED next to the personal line lights steadily; however, the call is still on hold at the coverage receiver's telephone. The user who picked up the held call, therefore, cannot transfer the call. In order to transfer a call on hold at a Cover button, use Pickup instead of picking up on a personal line button.</p>
CTI Link	A CTI link application can put an SA button call on hold.

Digital Data Calls	Data calls cannot be put on hold. 2B data video calls require both B-channels at a video workstation.
Directories	The Hold button is used to enter the Pause special character in a telephone number programmed as a listing for a System Directory, Extension Directory, or Personal Directory.
Direct Station Selector	When one-touch Hold is programmed, only outside callers are automatically put on hold when a DSS button for a user, calling group, or paging group is pressed while another call is active. For an inside caller, pressing a DSS button for a user sends a manual signal to the user's extension; pressing a DSS button for a calling group or paging group has no effect.
Display	When a call is first put on hold, the display on an MLX telephone briefly shows <code>Call On Hold</code> . This message reappears each time the hold timer expires. On a QCC only, when a held call returns to the queue after the second hold reminder, the call is identified by call type and by the name and extension number of the operator who put it on hold. The second line of the QCC display also shows the caller information.
Fax Extension	If an extension is programmed as a fax extension, the telephone at that extension is unable to use the Hold feature.
Group Calling	A calling group member who has put a call on hold is considered unavailable for incoming calls. A user waiting in the calling group queue cannot put the call on hold.
Headset Options	Headset Auto Answer is automatically turned off when an MLX telephone user puts a call on hold.
HotLine	Hold is not available at HotLine extensions (Release 5.0 and later systems).
Inspect	If a user presses the Hold button while in Inspect mode, Inspect is canceled. The system puts the active call (if there is one) on hold.
Multi-Function Module	A single-line telephone connected to an MFM cannot put a call on hold because the MFM cannot send a switchhook flash.
Paging	A speakerphone paging call can be put on hold only by the originator. When an SA or ICOM Voice button is used, however, to make an inside voice-announced call, either the originator or the person being called can put the call on hold.
Park	When a user or operator parks a call received on a personal line button and the call is picked up at another extension and then put on hold, other users who share the personal line cannot press the line button and pick up the call.

Personal Lines and Pickup

The hold timer or operator hold timer applies to a call on hold for transfer. The user or operator hears a reminder (a beep or abbreviated ring) after the timer expires.

If a call is received on a personal line and is transferred to another user who receives the call on an SA or ICOM button and then puts the call on hold, another user who shares the personal line cannot select the shared personal line button and pick up the call. If for some reason the person who received the transfer and put the call on hold cannot return to the call, another user must use Pickup to pick up the call. For example, an operator can take a message and then disconnect the caller.

In Release 2.1 and later systems, a call that has been put on hold at a Cover, SA, Shared SA, or Pool button can be picked up by a user who has a personal line button for the call. When the call is picked up, the green LED next to the personal line lights steadily; however, the call remains on hold at the Cover, SA, Shared SA, or Pool button. The user who picks up on the personal line cannot transfer the picked-up call. In order to transfer a call on hold at a Cover, SA, Shared SA, or Pool button, use Pickup instead of picking up on a personal line button.

Privacy

Privacy protects a call only while a user is active on the call. Privacy does not keep a user at another extension from picking up a call while it is on hold.

Recall/Timed Flash

Single-line telephones use a switchhook flash to put a call on hold by pressing and releasing the Recall or Flash button (or if the telephone does not have positive disconnect, the switchhook), depending on the telephone model.

Service Observing

In Release 6.1 and later systems Service Observers cannot place observed calls on hold. If a person at an observed extension presses Hold, the call is removed from the Service Observer until the call is re-accessed, at which point the Service Observer is reconnected to the call (if the extension is still being observed).

If a Service Observer with a DLC programmed for automatic Hold post-selects to another button while observing a call, the DLC is disconnected from the observed call. The call is not placed on hold.

Speed Dial

The Hold button is used to enter the Pause special character in a Personal Speed Dial or System Speed Dial telephone number.

System Access/ Intercom Buttons

If a call is put on hold on an SA or Shared SA button, it can be picked up at the principal extension's SA button or at any other Shared SA button corresponding to the button with the held call. The hold reminder is heard only at the extension that put the call on hold. In Release 2.1 and later systems, any user with a Shared SA button for the call can transfer the held call after picking it up on the SSA button.

Features
Hold

403

Transfer Calls on hold for transfer are timed so that a user or system operator hears a reminder after the timer expires.

In Release 2.1 and later systems, a call that has been put on hold at a Cover, SA, Shared SA, or Pool button can be accessed by a user who has a personal line button for the call. When the call is accessed, the green LED next to the personal line lights steadily; however, the call remains on hold at the Cover, SA, SSA, or Pool button. The user who accesses the personal line cannot transfer the call. To transfer a call on hold at a Cover, SA, SSA or Pool button, use Pickup instead of answering on a personal line button.

HotLine

At a Glance

Users Affected	Telephone users
Reports Affected	Extension Information
Modes	All
Telephones	Single-line telephones
System Programming	To assign a HotLine extension: ■ Extensions→More→More→HotLine→Dial ext. no.
Factory Setting	Disabled

Description

In Release 5.0 and later systems, the HotLine feature allows system managers to program single-line telephone extensions connected to 008 OPT, 012 (T/R), or 016 (T/R) modules for HotLine operation. Ports on the 412 LS-ID-ETR and 016 ETR modules that have been programmed for tip/ring operation may also be used for HotLine operation. When the HotLine feature is programmed, a user dials an inside or outside telephone number by lifting the handset of the telephone.

The HotLine feature works in conjunction with Personal Speed Dial programming (see [“Speed Dial” on page 648](#)) to automatically dial the first programmed Personal Speed Dial number (code 01) as soon as someone goes off-hook at the single-line telephone.

This feature is intended to allow easy access to a telephone number in sales, hotel, and other environments. HotLine extensions, for security reasons, are not intended to perform any function other than immediate and convenient dialing of a single telephone or extension number. Because a switchhook flash from a HotLine extension is not recognized by the system, the Hold, Conference, and Transfer features are not available.

If the single-line telephone includes a dialpad, a user can dial digits after the call is connected. This allows the use of an integrated voice response or Automated Attendant menu.

The HotLine feature uses the existing Personal Speed Dial code 01 for a single-line telephone extension. Prior to the assignment of an extension as a HotLine, the required Personal Speed Dial number can be programmed at the extension or through centralized telephone programming. After an extension has been programmed as a HotLine, there is only one opportunity to program a Personal

Speed Dial code at the telephone. For security reasons, any subsequent changes must be made through centralized telephone programming. No further programming of any kind can be performed at the telephone.

The Personal Speed Dial number used at a single-line telephone HotLine can be an inside extension number, an outside number including ARS or pool access codes (Hybrid/PBX mode only), a long-distance service access code, or an Idle Line Access code (usually 9). Personal Speed Dial numbers are limited to 40 characters.

A HotLine extension can access any personal, SA, or ICOM line normally used for outgoing voice calls, as programmed using Automatic Line Selection (ALS) or Idle Line Access (Key and Behind Switch modes). For outside calls, a personal line is recommended. For more information, see [“Automatic Line Selection and Ringing/Idle Line Preference” on page 69](#) (Key and Behind Switch modes), [“Personal Lines” on page 484](#), and [“System Access/Intercom Buttons” on page 673](#).



SECURITY ALERT:

If a HotLine extension dials out on a loop-start line, it must supply reliable disconnect and be programmed with Reliable Disconnect enabled. Otherwise, a caller may be able to make a toll call on the line after hanging up on a HotLine call.

If a HotLine extension is not intended to receive calls, its line should be set to No Ring.

Considerations and Constraints

The first Personal Speed Dial number (code 01) can be programmed at the single-line telephone prior to its assignment as a HotLine extension. After an extension is programmed as a HotLine, the Personal Speed Dial code can be programmed only once. Subsequent changes must be made using centralized telephone programming.

Because switchhook flashes are not recognized from HotLine extensions, the Hold, Conference, and Transfer features are not available.

HotLine extensions cannot dial Night Service passwords. For this reason, the Night Service Exclusion Lists may have to include HotLine extensions. Alternatively, the numbers dialed by HotLine extensions may have to be added to Night Service Emergency Lists.

Although the HotLine feature can be used with tip/ring devices such as modems, it is not intended for this use.

Many features cannot be used at HotLine extensions—for example, Last Number Dial, Saved Number Dial, Pickup, and Park. Features not normally available to single-line telephones (such as Do Not Disturb) are also not available to HotLine extensions. Other features such as calling restrictions and ARS, however, can be used at HotLine extensions. See the “Feature Interactions” topic in this section for more information.

A HotLine telephone cannot be connected to a Multi-Function Module (MFM) or General Purpose Adapter (GPA).

Telephone Differences

Only single-line telephones or tip/ring devices can be HotLine extensions.

Feature Interactions

Account Code Entry	HotLine extensions cannot use Account Code Entry.
Allowed/Disallowed Lists	Allowed and Disallowed Lists can be assigned to HotLine extensions.
Automatic Route Selection	A HotLine extension can use an ARS access code if it is programmed into the Personal Speed Dial number.
Barge-In	You can barge into HotLine calls.
Callback	Callback is not intended for HotLine extensions. Automatic Callback, however, may be used, if programmed, for inside and ARS (Hybrid/PBX mode only) calls. Selective Callback is also available.
Call Waiting	Call Waiting can be activated for a HotLine extension, but you cannot put the current call on hold and pick up a waiting call. Instead, you must hang up the current call and wait for the call-waiting call to ring.
Camp-On	HotLine calls can be camped onto, but a HotLine extension cannot camp on to calls.
Conference	Conference is not available at HotLine extensions.
Calling Restrictions	Calling restrictions can be programmed for HotLine extensions.
Coverage	Coverage features are not recommended for HotLine extensions.
Extension Status	Extension Status is not recommended for HotLine extensions, because a HotLine extension cannot dial the # codes needed to change the Extension Status.
Facility Restriction Level	The FRL value for Hotline extensions should be set to 6 to enable unrestricted access between private network switches.
Forward and Follow Me	Forward/Follow Me and Remote Call Forwarding are not intended for HotLine extensions (Release 5.0 and later systems). Sometimes, however, they may be inadvertently programmed at a Hotline extension; Forward/Follow Me and Remote Call Forwarding should be removed.

Forward and Follow Me (continued)	To remove Forward/Follow Me and Remote Call Forwarding at a Hotline extension, you must use a telephone at a non-HotLine extension and follow these steps: <ol style="list-style-type: none">1. Remove the Hotline feature from the extension.2. Cancel Forward/Follow Me or Remote Call Forwarding.3. Reassign the Hotline feature to the extension.
Group Calling Hold	From HotLine extension, you can dial a calling group extension number. Hold is not available at HotLine extensions.
Last Number Dial	Last Number Dial is not available at HotLine extensions.
Night Service	A HotLine extension (Release 5.0 and later systems) can be a member of a Night Service group. If you dial an outside call from a Hotline extension and Night Service with Outward Restriction is on, either the HotLine extension number must be in the Night Service Exclusion List or the number it dials must be on the Night Service Emergency List.
Paging	You cannot access Loudspeaker Paging from a HotLine extension, but a HotLine extension can be programmed to dial a Group Paging number.
Park	Park cannot be used by a HotLine extension.
Pickup	Pickup cannot be used at a HotLine extension.
Pools	A HotLine extension can use a pool, as long as dial-access-to-pools is enabled for the extension and the Pool access code is programmed with the outside number as the first Personal Speed Dial number for the extension.
Privacy	Privacy is not available for HotLine extensions.
Recall/Timed Flash	A switchhook flash from a HotLine extension is not sent to the system or the central office.
Ringing Options	Ringing Options can be set for HotLine extension lines. If the HotLine extension should not receive calls, set its line for No Ring.
Saved Number Dial	Saved Number Dial is not available at HotLine extensions.
Speed Dial	A HotLine extension can dial only the first Personal Speed Dial number (code 01) programmed for the extension. The end-of-dialing digit, #, should be programmed at the end of the speed dial number. See Appendix H, "Programming Special Characters," for additional information.
Transfer	Transfer is not available at HotLine extensions.
UDP Features	In Release 6.0 and later systems (Hybrid/PBX mode only), a HotLine extension must be on the local system. However, a HotLine telephone can dial a non-local extension.

Features

Idle Line Preference

408

Idle Line Preference

See [“Automatic Line Selection and Ringing/Idle Line Preference”](#) on page 69.

Inside Dial Tone

At a Glance

Users Affected	Telephone users, operators
Reports Affected	System Information (SysSet-up)
Modes	All
Telephones	All
System Programming	Options→InsideDial
Factory Setting	Inside dial tone

Description

The system's inside dial tone is heard when a user lifts the handset or presses the Speaker button after an SA or ICOM button is selected. Two choices are available for inside dial tone:

- **System Inside Dial Tone.** Makes it easy to distinguish inside and outside lines. (This is the factory setting.)
- **Outside Dial Tone.** Required by some adjuncts and applications connected to the system, such as voice messaging systems or modems, that do not recognize inside dial tone. With this setting, inside dial tone sounds just like outside dial tone.

Inspect

At a Glance

Users Affected	Telephone users, operators
Modes	All
Telephones	MLX display telephones

Description

Inspect allows an MLX display telephone user who is on a call to see call information about an incoming call that is ringing, alerting, or on hold.

Call information includes whether it is an inside or outside call, any programmed labels for the caller (such as the inside caller's name or the label assigned to the outside line), and how the call came to the user (transferred, coverage call, forwarded, and so on). Inspect also can be used to inventory what is programmed on the telephone's buttons.

To use Inspect to screen incoming calls while on another call or to identify callers on hold, press the Inspect button on the MLX display telephone and then press the line button with the incoming or held call. The call information is displayed on the Inspect screen.

To inspect a programmed button, press the Inspect button and then the programmed button. The name of the feature programmed on the button is displayed on the screen. Beginning with Release 2.0, however, pressing a programmed Last Number Dial or Saved Number Dial button shows the telephone number stored. If no number is stored, the feature name is displayed.

Considerations and Constraints

If the company subscribes to special services, such as AT&T's INFO2 ANI service or Caller ID, the display shows the outside telephone number of the person calling.



NOTE:

The availability of the caller identification information may be limited by the local-serving (caller's) jurisdiction, availability, or central office equipment.

When a line button is being inspected, it cannot be used to make or receive a call.

If a user inspects a line that someone else is using, the display shows that the line is in use. If Inspect is activated and someone makes a voice-announced call or a group page to the user, the Inspect feature is canceled and the Home screen is displayed.

Pressing the Feature, Menu, or Home button while Inspect is being used cancels Inspect. If a user is active on a call while using Inspect and presses a fixed-feature button (for example, the Hold, Transfer, or Drop button), the system cancels Inspect and attempts to activate the feature.

Telephone Differences

Direct-Line Consoles

Inspect cannot be used on analog Direct-Line Consoles (DLCs).

Queued Call Consoles

When a conference participant joins a conference by using a shared personal line or Shared SA button, the Queued Call Console (QCC) display is updated to include this participant. If a QCC operator uses the Inspect feature to verify the number of participants, however, the number shown on the display does not include participants joining the conference on the Shared SA or personal line button.

If a QCC operator presses any of the buttons programmed with fixed QCC features (for example, a Call, Start, or Source button) while in Inspect mode, the console remains in Inspect mode. If an operator presses the Feature, Transfer, HFAI, Conf, Mute, Drop, Speaker, or Hold button, however, the console is removed from Inspect mode.

Other Multiline Telephones

Inspect is available only on MLX display telephones.

Single-Line Telephones

Inspect cannot be used on single-line telephones.

Feature Interactions

Alarm	Inspect can be used on an MLX DLC or a QCC to display the number of system alarms.
Conference	If a user presses the Conf button while Inspect is active, the system cancels Inspect and tries to activate the Conference feature.

Direct Station Selector

Inspect can display limited information, such as extension number, label, and number of messages, for each DSS button. To use Inspect, an operator presses the Page button for the range of extensions, then the Inspect button, and then the DSS button for an extension. Inspect must be activated separately for each page on the DSS; to inspect another page, an operator presses the Home button and repeats the process.

When an operator inspects a DSS button associated with an extension, Line 1 of the display shows the extension, the label associated with the extension, if any, and the number of messages that have been left for that extension, if any. If the extension has posted a message, Line 2 shows the posted message.

In Release 2.0 and later systems, an operator can inspect a DSS button with a red LED on to see whether the extension is busy or using Do Not Disturb. If the user at the extension has turned on Do Not Disturb, the Do Not Disturb message is posted and appears on the operator's display. The message, however, may sometimes mean that the user has posted the message without turning on the Do Not Disturb feature.

Drop

If a user presses the Drop button while active on a call with Inspect activated, the system cancels Inspect and attempts to activate the Drop feature.

Group Calling

Any MLX telephone user can inspect the number of calls in the calling group queue by pressing the Inspect button and then pressing a button programmed with the calling group's extension, the Calls-in-Queue Alarm button. The display shows the label associated with the calling group and the number of calls in the queue.

If you press the Inspect button after answering a call, the calling group label is replaced with GrpCl.

Hold

If a user presses the Hold button while active on a call with Inspect activated, the system cancels Inspect and tries to put the call on hold.

Last Number Dial

Starting with Release 2.0, if a programmed Last Number Dial button is inspected, the display shows the last number stored for dialing. If no number is stored, only the feature name is displayed.

Paging

If a user receives a voice-announced inside call or a group speakerphone page while using the Inspect feature, the Inspect feature is canceled and the user is returned to the Home screen.

Saved Number Dial

Starting with Release 2.0, if a programmed Saved Number Dial button is inspected, the display shows the last number stored for dialing. If no number is stored, only the feature name is displayed.

Transfer

If a user with Inspect activated tries to transfer a call by pressing the Transfer button while active on a call, Inspect is canceled and the user is returned to the Home screen.

Labeling

At a Glance

Users Affected	Telephone users, operators
Reports Affected	Dial Plan, Direct Group Calling Information, Extension Directory, Group Coverage Information, Label Information, Operator Information, System Directory
Modes	All
Telephones	Display telephones
System Programming	<p>Create, change, or delete System Directory listings:</p> <ul style="list-style-type: none"> ■ More→Labeling→Directory→System <p>Assign extension labels:</p> <ul style="list-style-type: none"> ■ More→Labeling→Directory→Extension <p>Create, change, or delete Personal Directory listings:</p> <ul style="list-style-type: none"> ■ More→Labeling→Directory→Personal <p>Assign outside line/trunk labels:</p> <ul style="list-style-type: none"> ■ More→Labeling→LinesTrunks <p>Assign calling group labels:</p> <ul style="list-style-type: none"> ■ More→Labeling→Grp Calling <p>Create, change, or delete posted messages:</p> <ul style="list-style-type: none"> ■ More→Labeling→PostMessage
Maximums	
System Directory Labels	11 characters for each label
Extension Labels	7 characters for each label
Line/Trunk Labels	7 characters for each label
Calling Group Labels	7 characters for each label
Posted Messages	16 characters for each message; 20 messages
Factory Settings	
Posted Messages	<p>1 fixed message</p> <p>9 preset but modifiable messages</p> <p>10 blank custom messages available for customer use</p>

Description

Through the use of the Labeling feature, the system manager can program the system to provide identification information (called *labels*) and posted messages on display telephones. Alphanumeric labels can be assigned to the following:

- **System Directory Listings.** To identify the company or person associated with a specific System Speed Dial number. This information appears when a user activates the System Directory.
- **Extension Directory Listings.** To identify the name of a person or room (for example, a conference room) associated with an extension. This information displays when a user receives an inside call, when a co-worker leaves a message, or when a user accesses the Extension Directory.
- **Personal Directory Listings.** To identify the name of the person or business associated with a frequently called personal number. This information is displayed when an MLX-20L user accesses a Personal Directory.
- **Outside and Tandem Lines/Trunks.** To identify the type of line/trunk (for example, WATS or tie), the telephone number, or the department to which the line/trunk belongs. This information displays when a user makes or receives a call.
- **Calling Groups.** To identify the group. This information is displayed when a group member answers a group call.
- **Non-Local UDP Extensions** (Release 6.0 and later systems, Hybrid/PBX mode only). Depending upon display preference settings and trunk type, the alphanumeric label for non-local network extensions can appear on the displays for incoming calls to MLX display telephones. For additional information, see [“Uniform Dial Plan Features” on page 741](#) and [“Display” on page 271](#).

Labeling is also used to create messages that can be posted to a caller with a display telephone to explain why a person is not answering his or her telephone. Each posted message has a number. To post a message, enter the message number. [Table 25](#) lists the factory-set posted messages and their numbers. When another user with a display telephone calls, the message is displayed on the caller's telephone. (See [“Messaging” on page 429](#) for additional information about how to post a message.)

Table 25. Factory-Set Posted Messages and Their Codes

Number	Message
01	DO NOT DISTURB (not modifiable in Release 2.0 and later systems, modifiable in earlier releases)
02	OUT TO LUNCH (modifiable)
03	AT HOME (modifiable)
04	OUT SICK (modifiable)
05	IN A MEETING (modifiable)
06	IN A CONFERENCE (modifiable)
07	WITH A CLIENT (modifiable)
08	WITH A CUSTOMER (modifiable)
09	AWAY FROM DESK (modifiable)
10	OUT ALL DAY (modifiable)
11–20	CUSTOM MSG 11, 12, . . . (for customer-created messages)

Considerations and Constraints

If a label is assigned to the extension, the MLX telephone user sees the label, the extension number, and the posted message, for example, STEVE B Ext 7101 OUT TO LUNCH. If a label is not assigned to an extension and a caller dials that extension, the telephone's extension number is displayed (instead of the user's name), along with any posted messages. For example, an MLX display telephone user sees Ext 7103 OUT TO LUNCH.

If labels have not been assigned to operator extensions, display telephone users see *Operator* and the operator's extension number when receiving a call from the operator.

If labels have not been assigned to outside lines/trunks, display users see the factory-set label, *OUTSIDE* and the line/trunk number (such as Trk 810), when an outside call is made or received. With AT&T's PRI-ANI service, another PRI calling party number service, or Caller ID service and an 800 GS/LS-ID, 408 GS/LS-ID-MLX, or 412 LS-ID-ETR module (loop-start lines only), the caller's number is displayed (MLX, ETR, and MLS display telephones). If you use PRI service of any kind, you must have a 100D module. To use Caller ID, you must have loop-start lines. AT&T's PRI-ANI service provides only the caller's number. Beginning in Release 7.0, you can view both number and name, but not simultaneously.



NOTE:

The availability of the caller identification information may be limited by local-serving (caller's) jurisdiction, availability, or central office equipment. Programmed labels cannot be shown on nondisplay telephones or on single-line telephones.

Labels that are programmable by a user are displayed in all capital letters.

Labels can contain capital letters, numbers, and eight types of characters: ampersands (&), dashes (-), spaces, periods (.), commas (,), apostrophes('), asterisks (*), and pound signs (#).

Telephone Differences

Multiline Telephones

Only MLX-20L telephone users can have Personal Directories. Labels for the entries in this directory can be programmed by the system manager, using system programming, or by the MLX-20L telephone user at the extension.

Feature Interactions

Directories

An MLX extension programmed as a CTI link (Release 5.0 and later systems) is automatically assigned the Extension Directory label `CTILINK`. This label can be changed using the Labeling feature.

Labeling is used to enter the names of the persons or businesses associated with the System Speed Dial numbers stored as listings in the System Directory. It is also used to enter the names of people, groups, and locations associated with the extensions in the system stored as listings in the Extension Directory. Labeling is used to enter the telephone numbers and label information associated with Personal Directories on MLX-20L telephones, and this information also can be programmed by the user at the extension.

Do Not Disturb

Posted message 01, `DO NOT DISTURB`, is modifiable prior to Release 2.0. Starting with Release 2.0, when an MLX user activates the Do Not Disturb feature, the Do Not Disturb message is automatically posted. Therefore, in Release 2.0 and later systems, this posted message is not allowed to be changed. (The message may be posted even if the user does not activate Do Not Disturb.)

Group Calling

An alphanumeric label can be assigned to the calling group. The label is displayed when a group member answers a group call or when an MLX display telephone user presses the `Inspct` button and an `Auto Dial` button programmed with the calling group's extension number.

Messaging

The labels stored in the Extension Directory appear on MLX display telephones when users send each other messages. Messages include the name (the 7-character label) of the user who sent the message and the time and day the user called. Posted messages are created and changed by using Labeling.

Speed Dial

The telephone numbers associated with System Speed Dial codes are entered by using the programming screens to program labels for System Directory listings.

UDP Features

For incoming calls, the alphanumeric label and/or extension number for non-local dial plan extensions appears on local system MLX and ETR displays according to display preference programming. This feature works only when PRI tandem trunks convey the calls.

When operators make intersystem calls, you should relabel the default OPERATR label to distinguish operators in different systems.

The system supports the display of DEFINITY ECS or DEFINITY ProLogix Solutions extension labels, although long DEFINITY ECS or DEFINITY ProLogix Solutions labels may be truncated on MERLIN LEGEND Communications System MLX and ETR displays, which support a maximum of seven characters for name labels and seven characters for extension number labels.

Language Choice

At a Glance

Users Affected	Telephone users, operators, system manager
Reports Affected	Extension Information, SMDR, System Information (SysSet-up)
Modes	All
Telephones	MLX and ETR telephones
Feature Codes	
English	790
French	791
Spanish	792
System Programming	Select a language for the entire system: ■ More→Language→SystemLang Select a language for an extension: ■ More→Language→Extensions Select a language for SMDR headers: ■ More→Language→SMDR Select a language for printing programming reports: ■ More→Language→Printer
Factory Settings	
System Language	English
Extension Language	English
SMDR Report Language	English
Programming Report Language	English
SPM Language	English



NOTE:

Language choice is available with Release 1.1 and later systems.

Description

Since Release 1.1, the system supports system operation and programming in three languages: English, French, and Spanish. This enables system managers and MLX and ETR telephone users to customize aspects of the system for their linguistic convenience.

- The system manager can program the entire system to operate in English, French, or Spanish, including MLX and ETR prompts and displays, SMDR headings, and system programming reports.

- The system manager can program specific extensions or consecutive blocks of extensions in English, French, or Spanish as necessary. In addition, an individual MLX or ETR telephone user can choose the language most appropriate for his or her own extension.
- The system manager can program SMDR report headers, the headings, and the text of system programming reports to be printed in English, French, or Spanish.
- A user of SPM software can select English, French, or Spanish as the language for SPM's displays and messages.
- MLX-5D, MLX-10D, MLX-16DP, MLX-20L, and MLX-28D display telephones and MLX-10 and MLX-5 nondisplay telephones can be obtained with factory-imprinted buttons in English, French, or Spanish.

System Language

Through system programming, the system manager selects a language for the entire system, determining the language used for all MLX and ETR telephone displays, SMDR headings, system programming reports, and maintenance displays.

Extension Language

MLX and ETR telephones can operate in English, French, or Spanish, independently of the system language. The language for an extension is chosen either by the system manager through system programming or by a user at the extension. This setting also controls the Reminder and Alarm Clock features on MLX telephones using a 12-hour clock on telephones operating in English and a 24-hour clock on telephones operating in French or Spanish. Also, on ETR telephones, time appears in 24-hour format when French or Spanish has been programmed as the system language.

After the user selects a language, the choice is confirmed on Line 2 of MLX display telephones. If the choice is English, the display shows the words *In English*. If the choice is French, the display shows the words *En français*. If the choice is Spanish, the display shows the words *En español*.

After five seconds, Line 2 changes, displaying the date and time. In English, the date is shown as *month day*; the time is shown in 12-hour format (a.m. or p.m.). In French and Spanish, the date is shown as *day month*; the time is shown in 24-hour format. At MLX nondisplay telephones, the only effect of this selection is a different time format (12-hour clock versus 24-hour clock), which is required when dialing times for the Reminder feature.

SMDR Report Language

Through system programming, SMDR reports can be printed with headers in English, French, or Spanish, regardless of the language selected for the system or for SPM.

Programming Report Language

Through system programming, programming reports can be printed in English, French, or Spanish, regardless of the language selected for the system or for SPM.

SPM Language

Unlike the SMDR and programming report languages, which are selected through system programming, the SPM language is selected by the SPM user. When the software is first installed, the user is prompted (in English) for line speed, color or black-and-white monitor, and other configuration options. These selections are stored in a system-created configuration file `c:\spm\ams.cfg` (DOS version) or `/usr/ams/ams.cfg` (UNIX System version). The language selection made at this time determines whether SPM menus, pop-up windows, and other messages are presented in English, French, or Spanish. A second language selection option on the SPM screen affects messages from the control unit to SPM and controls the 7-line by 24-character console-simulation window for the duration of the session. These two language options operate independently of each other. An SPM user, for example, can select English for one and French for the other.



NOTE:

The graphical user interface (GUI) part of WinSPM is available only in English. The DOS-emulation part of the WinSPM package is available in the same languages as DOS-SPM.

The following discussion refers to the language specified in the SPM configuration files as the *PC language*, and the language used by the control unit as the *console window language*.

PC Language

Once a PC language is chosen at initial installation, that selection is written into the configuration file and becomes the default language. Invoking SPM calls that particular language selection. If a user wishes to specify a different language, he or she can do so using the `-l` option as follows:

```
spm -l english
```

spm -l french

spm -l spanish

Note that the option is a lowercase letter L, not the number 1. Use of the -l option changes the language attribute in the SPM configuration file. The language specified becomes the new PC language, which is used whenever SPM is started without the -l option.

Console Window Language

Because the console window language selection is made only after the selection of the PC language, the language used in the 7-line by 24-character console simulation window always defaults to the PC language. However, by pressing **F10** and making a selection, the SPM user can select a different language for this window for the duration of the current session.

Considerations and Constraints

After a System Reset (cold start), the system language reverts to the default setting, English.

In a system release prior to Release 1.1, if a user attempts to set the language on a telephone, he or she hears a reorder tone or an error beep.

When the system and extension language selections are different, the extension language takes precedence.

Telephone Differences

Multiline Telephones

Language choice is supported on MLX and ETR telephones.

Because the extension language takes precedence over the system language, Alarm Clock (MLX and analog multiline display telephones only) and Reminder differ, depending on the language used at an extension. When the extension language is set for English or the system language has been set for English and no extension language selection has been programmed, MLX and ETR telephone users set the Alarm Clock and Reminder features by using 12-hour time (a.m. or p.m.). (ETR telephone users can only use Reminder.) When the extension language is French or Spanish, or the system language is set for French or Spanish and no extension language has been chosen, MLX and ETR telephone users set the Alarm Clock and Reminder features using 24-hour time. (ETR telephone users can only use Reminder.)

Features
Language Choice

422

Time also appears in a 24-hour format on ETR telephones when French or Spanish has been chosen as the system language.

Feature Interactions

Alarm Clock and Reminder Service

Enter the time settings for Alarm Clock and Reminder according to the language selection governing the extension. If the language selection is English, the time setting for Alarm Clock and Reminder must be entered in 12-hour format (0100–1259) followed by either a 2 (A) for a.m. or a 7 (P) for p.m. If the governing language selection is French or Spanish, the time setting must be entered in 24-hour format (0000–2359).

Last Number Dial

At a Glance

Users Affected	Telephone users, operators, data users
Reports Affected	Extension Information
Modes	All
Telephones	All except QCC
Programming Code	*84
Feature Code	84
MLX Display Label	LastNumDial [Last#]
Maximums	1 Last Number Dial button for each multiline telephone 16 digits saved by Last Number Dial

Description

Last Number Dial automatically saves the last number dialed from an extension and allows the user to call the number again without manually redialing. The number is saved even if the called party answers.

The number saved is any extension or telephone number dialed in any of the following ways:

- Manually dialing the complete number on the dialpad.
- Dialing the number using a Personal Speed Dial code.
- Dialing a number using a programmed outside Auto Dial button.
- Dialing a number using a programmed Saved Number Dial button.

Each time a user dials a new number using any of these methods, the old number saved for Last Number Dial is erased and replaced with the new number.

Considerations and Constraints

Only one Last Number Dial button can be programmed on each multiline telephone.

A maximum of 16 digits is saved by Last Number Dial.

Because the type of line button used to make the call (personal line, SA, or ICOM) is not stored, the user must select the appropriate line button before using Last Number Dial to redial a number.

Last Number Dial saves whatever you dial, whether or not the number is valid.

If the user dials a telephone number and, after the call is connected, the user dials additional digits, such as an account number or password, Last Number Dial saves all digits, including those dialed after the call is connected. In addition, if someone other than the owner of a display telephone presses the Last Number Dial button, all dialed digits are shown on the display, including confidential information such as passwords or account codes.

Last Number Dial does not store numbers dialed through an Extension, Personal, or System Directory, an inside Auto Dial button, a System Speed Dial code, or a DSS button.

If the number is dialed using an outside Auto Dial button or Personal Speed Dial code and includes a special character such as Pause or Stop, the special character does not work when the number is redialed using Last Number Dial.

Mode Differences

Behind Switch

In Behind Switch mode, when a user manually dials an outside number that includes a dial-out code (for example, an ARS or pool dial-out code) required by the host system, the pauses to wait for dial tone required by some host systems are not automatically stored for Last Number Dial. As a result, a user may either hear a fast busy signal or reach a wrong number when using Last Number Dial.

Key Mode

Analog multiline telephones in Key mode can use Last Number Dial only if a Feature button is programmed. This Feature button is used instead of the # button to activate the feature code.

Telephone Differences

Queued Call Consoles

Last Number Dial cannot be used on QCCs.

Other Multiline Telephones

To redial a number using Last Number Dial on a multiline telephone, select the appropriate personal line (outside line) or SA button for the call. Then either press the programmed Last Number Dial button, or press the Feature button and dial 84. The number saved by the feature is dialed automatically. On MLX display telephones, press the Feature button and select `LastNumDial [Last#]` from the display.

Single-Line Telephones

To redial a number using Last Number Dial, lift the handset (the telephone must connect to an SA or ICOM line), and then dial #84. The number that was last dialed is redialed automatically.

Feature Interactions

Authorization Code	For security reason, an authorization code is not saved by the Last Number Dial feature. When you activate the Authorization Code feature, you cannot use Last Number Dial. After you turn off Authorization Code, you can use Last Number Dial to dial the most recent number dialed.
Auto Dial	Last Number Dial does not store numbers dialed using an inside Auto Dial button. If a number containing special characters is dialed using an outside Auto Dial button, the special characters do not work when the number is redialed using Last Number Dial.
Digital Data Calls	Terminal adapters can use Last Number Dial by dialing the Last Number Dial feature code. Last Number Dial can be activated by video systems that can dial strings and feature codes that begin with #.
Direct Station Selector	An extension number dialed by pressing a DSS button is not stored for Last Number Dial.
Directories	Last Number Dial does not store a number dialed using a Personal, Extension, or System Directory.
Display	When a user presses a programmed Last Number Dial button, the digits appear on the display as if the user were dialing them from the dialpad.
HotLine	Last Number Dial is not available at HotLine extensions (Release 5.0 and later systems).
Inspect	In Release 2.0 and later systems, when a user presses <code>Inspct</code> and then a programmed Last Number Dial button, the saved number appears on the display. In Release 1.0 and 1.1 systems, when a user presses <code>Inspct</code> and then a programmed Last Number Dial button, <code>Last Number Dial</code> appears on the display.

Microphone Disable	When an MLX telephone user's microphone is disabled, pressing the programmed Last Number Dial button before lifting the handset turns on the speakerphone so the user can hear the number being dialed. Once the call is answered, however, the user must lift the handset to talk.
Recall/Timed Flash	Recall can be used on a call made with Last Number Dial on a personal line or Pool button (loop-start only), on an inside call, or, in Release 2.0 and later systems, on an outside call made on a loop-start line by using an SA or ICOM button.
Service Observing	In Release 6.1 and later systems extensions that use Last Number Dial to place a call can be observed.
SMDR	All outside numbers dialed using Last Number Dial are recorded on the SMDR report.
Speed Dial	Telephone numbers dialed using Personal Speed Dial are stored by Last Number Dial. However, if the number includes special characters such as Pause or Stop, the special characters do not work when the number is redialed using Last Number Dial. Telephone numbers dialed using System Speed Dial are not stored by Last Number Dial.
System Access/ Intercom Buttons	When Last Number Dial is used on a call made with a Shared SA button, the number is stored on the extension where Last Number Dial was used, not on the principal extension.
Transfer	Last Number Dial can be used to dial the outside number of the telephone to which the call is being transferred.

Line Request

At a Glance

Users Affected	Telephone users, operators
Modes	All
Telephones	All except MLC-5 cordless, MDC 9000, MDW 9000, QCC, and single-line telephones

Description

If a user wants to make a call on a busy outside line assigned to a button, Line Request notifies the user when the line becomes available. When an outside line is busy, the green LED next to the button is on or flashing.

Line Request is automatically available and does not require programming. To request the busy line, the multiline telephone user presses the line button for the busy line without lifting the handset. The red LED next to the line button turns on, and, when the line becomes available, the telephone automatically alerts the user with a beep. To make a call using the requested line, the user lifts the handset or presses the Speaker button.

Line Request is canceled if the user presses another line button or makes or receives a call.

Line Request applies to personal lines only, not to pools or to lines on SA or ICOM buttons. To complete calls to busy extensions, or to complete calls to outside numbers using a pool in which all lines/trunks are busy, use Callback.

Considerations and Constraints

Line Request does not reserve the line; it only alerts you that the line is available.

Line Request cannot be used for an SA or ICOM button.

Line Request cannot be used on a single-line telephone or on a Queued Call Console (QCC).

In Hybrid/PBX mode, Line Request cannot be used on a Pool button or for a busy pool.

Mode Differences

Hybrid/PBX Mode

In Hybrid/PBX mode, Line Request can be used for personal lines or special-purpose lines (such as WATS) assigned to line buttons on a multiline telephone. Callback should be used instead of Line Request to complete calls to busy extensions or to outside numbers when the call is made by using a pool in which the lines/trunks are busy.



NOTE:

Do not use Callback when your system includes a voice messaging system.

Key and Behind Switch Modes

Line Request works only for outside lines that are assigned to line buttons.

Telephone Differences

Queued Call Consoles

Line Request cannot be used on QCCs.

Other Multiline Telephones

Line Request cannot be used on MLC-5, MDW 9000 cordless, or MDC 9000 cordless/wireless telephones.

Single-Line Telephones

Line Request cannot be used on single-line telephones.

Feature Interactions

Callback	Returning Callback calls cancels Line Request.
Camp-On	Returning camped-on calls cancels Line Request.
Park	Returning parked calls cancels Line Request.
Pools	Line Request cannot be used on a Pool button.
System Access/ Intercom Buttons	Line Request cannot be used for an SA or ICOM button.
Transfer	Returning transferred calls cancels Line Request.

Messaging

At a Glance

Users Affected	Telephone users, operators
Reports Affected	Direct Group Calling Information, Extension Directory, Extension Information, Label Information
Modes	All
Telephones	All
Programming Codes	
Send/Remove Message	*38 (Operator only)
Leave Message	*25
Assign Posted Message Button	*751
Delete Message	*26 (Analog multiline, ETR, and MLS display telephones)
Return Call	*27 (Analog multiline, ETR, and MLS display telephones)
Next Message	*28 (Analog multiline, ETR, and MLS display telephones)
Scroll	*29 (Analog multiline, ETR, and MLS display telephones)
Feature Codes	
Send/Remove Message	38 + extension number (Operator only)
Leave Message	
After calling	25
Without calling	53 + extension number
Cancel Message Sent	*53 + extension number
Message LED off (for non-display telephones)	54
Message operation mode (for ETR, MLS, and analog multiline display telephones)	54; enters/exits Message operation mode. MLS and analog multiline telephones return to normal call handling after 15 seconds if the user has no messages. If an MLS or analog multiline telephone user has messages, he or she must delete the messages or use the feature code or programmed button to exit Message operation. An ETR telephone user must use the feature code or the programmed button to exit Message operation whether or not the he or she has messages.
Delete Message	26 (Analog multiline, ETR, and MLS display telephones)
Return Call	27 (Analog multiline, ETR, and MLS display telephones)
Next Message	28 (Analog multiline, ETR, and MLS display telephones)
Scroll	29 (Analog multiline, ETR, and MLS display telephones)
MLX Display Labels	
Delete Message	Messages,Delete Msg [Msgs,Delete]
Next Message	Messages,Next Msg [Msgs,Next]
Return Call	Messages,Return Call [Msgs,Call]
Leave Message	Leave Msg [LvMsg]
Posted Message	Messages,Posted Msg [Msgs,Post]
Send/Remove Message	Messages,Send/RmvMsg [Msgs,SdMsg]

System Programming	Change or add posted messages: <ul style="list-style-type: none"> ■ Labeling→More→PostMessage Identify fax extension jacks, assign fax message-waiting receivers, specify length of time before system sends fax message-waiting indication: <ul style="list-style-type: none"> ■ AuxEquip→Fax→Msg Waiting Assign a message-waiting receiver for a calling group: <ul style="list-style-type: none"> ■ Extensions→More→Grp Calling→Message
Maximums	
Messages for each display telephone	10
Message-Waiting Receivers for fax	4
Message-Waiting Receivers per calling group	1
Fax Message Threshold	10 seconds (range 0–30)

Description

Messaging features allow users to do the following:

- Send messages
- Receive messages
- Post messages

Sending Messages

The following features are used to send messages:

- **Send/Remove Message.** For operators only.
- **Leave Message.** For any user to leave a message for a co-worker with a display telephone.

Send/Remove Message

The Send/Remove Message feature, available only to operators, turns the Message LED on and off for any telephone connected to the local system. For telephones without a display, Send/Remove Message is the only way the Message LED can be turned on, unless either the extension is programmed as the message-waiting receiver for a fax machine or calling group, or the system has a voice messaging system connected (see [“Direct Voice Mail” on page 260](#)).



NOTE:

In Release 6.0 and later systems (Hybrid/PBX mode only), Send/Remove Message does not change the Message LED at a non-local extension.

A Send/Remove Message button is a fixed button on a Queued Call Console (QCC) and cannot be reassigned. On a system with 29 or fewer lines, Send/Remove Message is assigned by default to analog DLCs on button 34. On a system with more than 29 lines, Send/Remove Message is replaced with line 32.

On QCCs and MLX DLCs with an attached DSS, as well as on MERLIN II System Display Consoles, operators can use the LEDs next to the DSS buttons to determine whether *an operator* has turned the Message LED on. Before sending a message, the operator presses the Message Status button and checks the red LED next to the DSS button of the person to whom the message is to be sent; the red LED is on when a message from an operator is waiting and off if no message from an operator is waiting. The LEDs on the DSS do not go on when Message LEDs have been turned on by the Leave Message feature, a voice messaging system, a fax arrival, or a message left for a calling group. To leave a message-waiting indication when the LED is off, the operator presses the programmed Send/Remove Message button, followed by the DSS button or Auto Dial button for the person for whom the message is intended. The operator presses the Message Status button to return to normal call handling. MLX DLC operators also can press the Feature button and select the feature from the display.

**NOTE:**

In Release 6.0 and later systems (Hybrid/PBX mode only), Send/Remove Message Status does not work for a non-local extension.

If an operator sends a message while on a call, only an inside caller hears the touch tones; an outside caller does not.

When Message Status is on, if the LED next to a DSS button is on and an operator uses the Send/Remove Message feature, the user's message LED is turned off (unless the LED is also on for a reason other than an operator's using of Send/Remove Message). When the LED next to a DSS button is off and an operator uses the Send/Remove Message feature, the user's Message LED is turned on.

A DLC operator without a DSS can check message status by using Auto Dial buttons programmed with extension numbers. The red LED next to an Auto Dial button indicates whether the Message LED is on.

A QCC operator without a DSS cannot check message status. If an operator who cannot check status sends a message, that message can cancel a message-waiting indication sent by another system operator who used Send/Remove Message.

Leave Message

The Leave Message feature allows any user, including operators, to send messages to local system co-workers. For systems without a local voice messaging system (VMS), Leave Message works only with display telephones. For systems with a VMS, Leave Message works with display and non-display telephones that are subscribers to the VMS. If there is a local VMS, LED lights and a factory-set message are provided for non-display telephones.



NOTE:

In Release 6.0 and later systems (Hybrid/PBX mode only), you cannot use Leave Message to signal a non-local extension. The Leave Message feature works only when the sender, receiver, and VMS are on the same system.

When you call a co-worker with a display telephone and get no answer or a busy signal, press a programmed Leave Message button, or press the Feature button and dial 25. On MLX display telephones, select the feature from the display while listening to ringback or a busy tone. A message is sent to the display telephone user. The message includes the caller's name (if labels are programmed) or extension and the time and date of the call.

If the caller leaves another message for the same person before that person responds to a previous message, the previous message is overwritten. A person with a display telephone who has received a message sees only the caller's name (if labels are programmed) or extension and the date and time for the new message.

To use the Leave Message feature without calling a user, the multiline telephone user presses the Feature button (without lifting the handset) and then dials 53 and the person's extension number. QCC operators cannot use Leave Message without calling the user.



NOTE:

If the Message LED of the person getting the message is already on, using the Leave Message feature does not turn the LED off, even if an operator uses Leave Message to send a message to a display telephone user.

If there is no local VMS, when a person with any telephone tries to use the Leave Message feature to send a message to a person with a single-line telephone or a multiline telephone without a display, the caller hears a single beep indicating that a message must be left with an operator. If the caller has a display telephone, the message *Cannot Send Message* is displayed.



NOTE:

In Release 6.1 and later systems, if a user with a display telephone tries to send a message to a telephone that has coverage to Centralized Voice Messaging, no message is sent, but the display on the sender's telephone reads that the message *was* sent. The Message-Waiting light is not lit, and no error beep sounds.

When a user tries to use the Leave Message feature and the co-worker's message box is full, the co-worker's telephone continues to ring and the caller's telephone beeps once. If the caller has a display, *Message Box Full* is displayed, and the caller must leave a message with an operator or voice mail (if available).

Cancel a sent message by pressing the Feature button and dialing *53 plus the extension to which the message was sent. QCC operators cannot cancel messages they have sent.

Receiving Messages

When the Message LED on a telephone is on or when a single-line telephone user hears a stutter dial tone upon lifting the handset, there is a message waiting for that person or for the calling group (if the extension is programmed as a message-waiting receiver for a calling group). The message can be from the following sources:

- An operator
- A voice messaging system
- A fax machine, if the extension is programmed as a fax message-waiting receiver for fax transmissions
- Another user

Receiving messages and returning calls varies according to the display telephone being used (see [Table 26](#)).

Table 26. Receiving Messages Functions

Function	Display Telephone Action			
	MLX (including QCC)	ETR	MLS	Analog Multiline
Read message	Press the Menu button and select Messages from the display.	Press the Feature button and dial 54, or press a button programmed with *54.	Press the Feature button and dial 54, or press a button programmed with *54.	Press the Message button.
See rest of message	Press the More button.	Press the More button.	Press the Scroll button, or press the Feature button and dial 29.	Press the Scroll button, or press the Feature button and dial 29.
Next message	Select Next Message from the display.	Press a programmed Next message button, or press the Feature button and dial 28.	Press a programmed Next message button, or press the Feature button and dial 28.	Press a programmed Next message button, or press the Feature button and dial 28.
Return call	Select Return Call from the display.	Press a programmed Return Call button, or press the Feature button and dial 27.	Press a programmed Return Call button, or press the Feature button and dial 27.	Press a programmed Return Call button, or press the Feature button and dial 27.
Delete message	Select Delete Message from the display.	Press a programmed Delete Message button, or press the Feature button and dial 26.	Press a programmed Delete Message button, or press the Feature button and dial 26.	Press a programmed Delete Message button, or press the Feature button and dial 26.



NOTES:

- In Release 6.0 and later systems (Hybrid/PBX mode only), a message-waiting receiver for a calling group must be a local user on the same system as the calling group.
- In Release 6.1 and later systems (Hybrid/PBX mode only), a user cannot use Return Call to call a remote voice messaging system; he or she must dial the number manually.
- In Release 2.0 and later systems, when someone uses the Return Call feature for a voice messaging system, a call is returned to the voice messaging system, not to the specific VMI extension that sent the message-waiting code.

Display telephones show messages in reverse order of when they were received; the most recent message is displayed first. Each message is identified on the display, as described in [Table 27](#).

Table 27. Message-Waiting Display Identifiers

Type of Display Telephone	Identifier	Meaning
Analog multiline, MLS	*	New or unread message
	Call ext. or name	Message from caller's extension number or name
MLX, ETR	*	New or unread message
	ATT	Message from system operator (attendant)
	FAX	You have a fax
	VMS	You have a voice mail message
	EXT	Message from an extension (co-worker)

The type of message indicated does not allow a calling group message-waiting receiver to distinguish between a message left for the calling group and a fax or personal message.

Multiline telephone users with no display cannot use programmed message buttons or feature codes to answer messages. The Message LED is usually turned off by an operator. However, an analog multiline telephone user (excluding those with BIS-34 telephones) can turn off the Message LED by pressing the associated Message button. Users of BIS-34 telephones, ETR, MLS, MLX-5, or MLX-10 nondisplay telephones can turn off the LED by pressing the Feature button and dialing 54. Check with message sources (operator, fax, voice messaging) before turning off the LED.



NOTES:

- If you press the Feature button and dial 54 on an MLS or analog multiline display telephone, you enter Message operation mode. You can then delete messages, receive messages, and perform other message operations. To exit Message operation mode, you must delete all your messages or press the Feature button and 54 again. If you have no messages, the telephone returns to normal call handling mode after 15 seconds, even if you do not press the Feature button and 54.
- If you press the Feature button and dial 54 on an ETR display telephone, you enter Message operation mode. You remain in this mode until you press the Feature button and dial 54 again. You cannot turn on message-waiting lights at non-display telephones by using an ETR telephone.

Fax Message-Waiting Receivers

The Fax Message-Waiting feature notifies designated extensions of the arrival of fax transmissions. Up to four extensions can be programmed to receive a message-waiting indication when a fax transmission is received on a specific fax machine. The Message LED goes on when the fax message threshold is exceeded. The fax message threshold is the length of time (0–30 seconds) before the system assumes that a fax has arrived.



NOTES:

- In Release 6.0 and later systems (Hybrid/PBX mode only), fax message waiting does not function unless the fax extensions and user extensions are located on the same system.
- Return Call is not operable for messages received from a fax machine and cannot be used to make a call to the fax.
- Fax machines only can send message-waiting indications. They cannot receive message-waiting indications.

Calling Group Message-Waiting Receivers

An extension can be programmed as the message-waiting receiver for a calling group. The user can receive personal messages or messages intended for the calling group from any of the sources listed under “Receiving Messages” above.



NOTE:

In Release 6.0 and later systems (Hybrid/PBX mode only), a message-waiting receiver for a calling group must be a local user on the same system as the calling group.

Posted Messages

Users can post a message to provide special information to co-workers with display telephones—for example, to tell callers where the person is when not answering the telephone or why the person does not want to be disturbed. When a user with a display telephone calls a co-worker who has a message posted, the posted message is shown on the caller’s display (even if the call is answered). Users do not need a display telephone to post a message.



NOTE:

In Release 6.0 and later systems (Hybrid/PBX mode only), posted messages do not work across a private network. They only work for extensions connected to the same local system.

Twenty different posted messages can be programmed in the telephone system. Ten messages are factory-set and nine of them can be changed. Posted message 01, DO NOT DISTURB, cannot be changed. Ten additional messages can be programmed and are factory-set as CUSTOM MSG ##.

The factory settings for posted messages are shown in [Table 28](#).

Table 28. Posted Messages

01 DO NOT DISTURB	06 IN CONFERENCE	11 CUSTOM MSG 11	16 CUSTOM MSG 16
02 OUT TO LUNCH	07 WITH A CLIENT	12 CUSTOM MSG 12	17 CUSTOM MSG 17
03 AT HOME	08 WITH A CUSTOMER	13 CUSTOM MSG 13	18 CUSTOM MSG 18
04 OUT SICK	09 AWAY FROM DESK	14 CUSTOM MSG 14	19 CUSTOM MSG 19
05 IN A MEETING	10 OUT ALL DAY	15 CUSTOM MSG 15	20 CUSTOM MSG 20

See [“Labeling” on page 413](#) for more information about creating posted messages.

Users with MLX display telephones can post a message by pressing the Menu button, selecting *Posted Msg [Post]* from the display, selecting the desired message, and selecting *Post*.

Users with analog multiline, ETR, MLS, MLX-5, or MLX-10 nondisplay telephones must use programming code *751 to program a Posted Messages button. To post a message, press the programmed Posted Messages button; the green LED next to the button flashes. Then dial the code for the desired message; the LED next to the button becomes steady. To cancel a posted message, press the programmed Posted Messages button and dial 00; the green LED next to the button turns off.



NOTE:

The system can automatically post and remove messages for a non-display telephone only if a Posted Messages button has been programmed for that telephone.

In Release 2.0 and later systems, when a user turns on the feature, the system automatically posts the message `DO NOT DISTURB`. Users with ETR, MLS, analog multiline, MLX-10, or MLX-5 nondisplay telephones must program a Posted Message button in order to display the message for callers. This message appears on the Home screen of an MLX display telephone with Do Not Disturb turned on. `DO NOT DISTURB` also appears on the screen of any MLX, MLS, and analog multiline telephone that is used to call an extension that has the feature turned on. When you turn off Do Not Disturb, the system automatically removes the message.

You can post or remove a Do Not Disturb message by pressing a programmed Posted Messages button. This, however, does not turn the Do Not Disturb feature on or off.

Considerations and Constraints

In Release 2.0 and later systems, if a user at an analog multiline, MLS, MLX-5, or MLX-10 telephone has a programmed Posted Message button and the Do Not Disturb feature is turned on, the system automatically posts the Do Not Disturb message for callers with display telephones. The programmed button is not required at MLX and ETR display telephones. When the feature is turned off, the message is canceled. Posting or canceling the Do Not Disturb message, however, does *not* turn the feature on or off.

A user does not need a display telephone to use the Leave Message feature, but the person to whom the message is sent must have a display telephone. Unlike Send/Remove Message, when the Leave Message feature is used to send a message to a person whose Message LED is on, the LED is not turned off even if the caller is an operator.

If an operator uses the Send/Remove Message feature while on a call, only an inside caller hears the touch tones; an outside caller does not. If 10 messages have been stored and a user tries to send an eleventh message, the caller hears a beep and display telephones show `Message Box Full`.

Responding to messages by using Return Call does not delete the message. The user must delete all messages before the Message LED turns off.

A fax machine can send the message-waiting indication but cannot be assigned as a message-waiting receiver for either another fax or for a calling group.

If a fax message-waiting indication is deleted by one of the four message-waiting receivers, the message is deleted from all analog multiline and MLS display telephones programmed as message-waiting receivers for the fax, but the message is not deleted from MLX and ETR display telephones programmed as message-waiting receivers for the fax.

Each calling group can have only one extension assigned as its message-waiting receiver, but the same extension can be assigned as the message-waiting receiver for more than one calling group.

Messages can be posted only by using a programmed button or, for MLX display telephone users, by selecting the feature from the display.

A single-line telephone user cannot post a message.

When a user posts a nonexistent message, `CUSTOM MSGnn` is displayed, indicating that the system manager has not programmed a message for this message number.

Only multiline display telephone users see posted messages. Users with single-line telephones or multiline telephones without displays cannot receive messages posted by other users.

Posting a message does not prevent the telephone from ringing.

Message Waiting does not work for off-premises telephones.

In Release 6.0 and later systems (Hybrid/PBX mode only), messaging features do not work across a private network. They only work for extensions connected to the same local system.

Telephone Differences

Direct-Line Consoles

The Send/Remove Message feature is an operator-only feature used by a DLC operator to turn on the Message LED to indicate a message waiting. For telephones without a display, Send/Remove Message is the only way the Message LED can be turned on and off by operators.

A Send/Remove Message button is factory-assigned to an MLX-28D used as a DLC. On a system with 29 or fewer lines, Alarm, Night Service, and Send/Remove Message are assigned by default to analog DLCs on buttons 32 through 34. On a system with more than 29 lines, Alarm, Night Service, and Send/Remove Message are not assigned to a DLC; instead lines 30 through 32 are. The first 18 lines on an MLX DLC are always factory-set as personal lines.

Queued Call Consoles

A Queued Call Console (QCC) operator can use Leave Message only by selecting the feature from the display. A QCC operator cannot cancel a sent message. A Send/Remove Message button is programmed as a fixed feature on a QCC.

Other Multiline Telephones

The 5-button analog multiline telephone (no longer available) has neither a Message LED nor a Message button.

MDC 9000 and MDW 9000 telephones cannot receive Leave Message or Posted Message messages. They can receive operator (Send/Remove Message) and voice mail message notification. When the telephone is turned on, MSG appears on the display.

Single-Line Telephones

Single-line telephone users cannot post a message.

To use the Leave Message feature while listening to ringback or the busy tone on a single-line telephone, dial #25. To use Leave Message without calling the extension, lift the handset (the telephone must connect to an SA or ICOM button), then dial #53 and the person's extension number.

If a single-line telephone sends a message to a nondisplay telephone user and there is no voice messaging system, the caller receives no error indication, and no message is sent.

If the receiver's message box is full or the receiver uses a single-line telephone or a multiline telephone without a display, the caller hears a beep indicating that the message has not been left.

To cancel a message sent, lift the handset and dial #*53 and the extension number where the message was left.

Single-line telephone users without a Message LED hear a stutter dial tone when a message is waiting. A single-line telephone user cannot respond to messages by using feature codes. Normally, if a single-line telephone has a Message LED, it is turned off by an operator. However, a single-line user can turn off the Message LED by lifting the handset and (while listening to inside dial tone) dialing #54. Check with all message sources (system operator, fax, voice messaging) before turning off the LED.

Feature Interactions

Barge-In	If Barge-In is used to contact a user with a posted message, the caller's telephone does not display that message.
Centralized Voice Messaging	<p>A Leave Word Calling message cannot be sent to a non-local extension. If a user with a display telephone tries to send a message to a telephone that has coverage to Centralized Voice Messaging, no message is sent, but the display on the sender's telephone reads that the message was sent. The Message-Waiting light is not lit, and no error beep sounds.</p> <p>MLX and ETR display telephone users cannot use Return Call across a private network; therefore, Return Call cannot be used with Centralized Voice Messaging.</p>
Digital Data Calls	Messaging features are not available for data or video extensions, but can be used by telephones at these workstations.
Directories	When an Extension Directory is used to call a co-worker with a posted message, the posted message is not displayed on the caller's telephone.
Direct Station Selector	When an operator presses the Message Status button on a DSS adjunct, the LEDs on the DSS reflect only messages left by an operator using the Send/Remove Message feature and not messages left by any user (including an operator) using the Leave Message feature.
Display	<p>When users try to send messages to an extension with a full message box, they see <i>Message Box Full</i> on the display. When a user tries to retrieve messages and the message box is empty, <i>No Messages</i> appears.</p> <p>When a user has a message from a local co-worker, the display shows the name or extension number (if no label is programmed) of the caller and, on MLX and ETR telephones, the time and date the message was left. An unread message is marked with an asterisk (*).</p> <p>Messages also can be received from outside callers or non-local extensions (if the MERLIN LEGEND System has a voice messaging system) and from an operator. On MLX and ETR display telephones, messages left by a voice messaging system are identified as <i>VMS</i>, messages from an operator are identified as <i>ATT</i>, and message-waiting indications received by a fax message-waiting receiver are identified as <i>FAX</i>. Analog multiline and MLS telephone users see <i>Call</i> plus the extension or caller's name.</p>

Do Not Disturb	<p>In Release 2.0 and later systems, when Do Not Disturb is turned on, the system automatically posts <code>DO NOT DISTURB</code>, which appears both on the Home screen of an MLX display telephone user with the feature activated and on the screen of any inside display telephone user who calls that person. The system automatically removes the Do Not Disturb message when the user turns off the feature. Users at analog multiline, ETR, or MLS telephones, or at MLX-5 or MLX-10 nondisplay telephones must program a Posted Messages button for the system to automatically post or remove the message when the feature is turned on or off. A user can post or remove a Do Not Disturb message by pressing a programmed Posted Messages button. However, this does not turn the Do Not Disturb feature on or off.</p>
Fax Extension	<p>Return Call does not work for messages received from a fax machine and cannot be used to make a call to the fax.</p>
Group Calling	<p>Users can leave messages for the calling group only if the system has been programmed with a designated message receiver for the calling group. The calling group also receives fax message-waiting indications directed to the calling group. The message-waiting receiver cannot distinguish messages left for the calling group from fax or personal messages.</p>
HotLine	<p>If the HotLine extension is programmed to dial an outside call, that telephone number must be in the Night Service Exclusion List or a Night Service Emergency number. If the HotLine is programmed to dial an inside extension, the user can dial #25 to leave a message. The HotLine extension cannot dial any other number except the one assigned to it.</p>
Labeling	<p>The labels stored in the Extension Directory appear on MLX display telephones when users send each other messages. Messages include the name (7-character label) of the user who sent the message and the time and day the user called. Posted messages (except for posted message 01, <code>DO NOT DISTURB</code>) are created and changed using Labeling.</p>
Multi-Function Module	<p>If a single-line telephone with a Message LED is connected to an MFM, it can receive message-waiting indications.</p>
Service Observing	<p>In Release 6.1 and later systems, if a Service Observer is deleting a Leave Word Calling (LWC) message at an MLX telephone, he or she cannot use Service Observing until the task is completed. If a caller is leaving an LWC message at an extension, the call cannot be observed.</p> <p>If a Service Observer is retrieving a message or posting a message, he or she can use the Service Observing feature. If an extension returns a call by using Message Return Call, the call can be observed when it is answered.</p> <p>If a Service Observer on a DLC is using Operator Inspect of Messages at an extension, he or she can observe calls.</p>

**Service Observing
(continued)**

When a Service Observer observes an extension that has activated Do Not Disturb, the Service Observer does not receive the Do Not Disturb posted message.

While a DLC programmed for Service Observing is using Send/Remove Message, it can be used to observe extensions.

Signal/Notify

If a display telephone user presses only a Signaling button to send an audible signal to an extension, a posted message at the destination is not shown on the signaler's display. However, if a display telephone user selects an SA or ICOM button, lifts the handset, and uses the Signaling button to dial the extension, the message appears.

**System Access/
Intercom Buttons**

When a Shared SA button is used to leave a message for a display user, the extension shown is that of the telephone with the SSA button and not that of the principal owner. When a principal extension owner with an MLX display telephone posts a message and a call is answered at the Shared SA button, the Home screen on which the posted message was previously shown is not restored. If the principal owner either presses the Home button or makes or receives a call, the Home screen is restored.

Transfer

If an inside call is transferred to an extension with a posted message, only the display telephone user who transfers the call, and not the original caller, sees the posted message, even after the transfer is completed.

If a call is transferred to an extension programmed as a fax extension, the message indication is not sent to the fax message-waiting receiver, regardless of the amount of time programmed for the fax message threshold.

A nondisplay telephone user who sends a message via Leave Message during a transfer cannot determine who receives the message. For example, suppose Extension A calls Extension B and Extension B transfers the call to Extension C. If Extension A sends a message before the transfer is complete, Extension B receives the message. If Extension A sends a message after Extension B completes the transfer, Extension C receives the message, even if Extension C does not answer and the call is ringing at Extension B as a transfer return.

UDP Features

In Release 6.0 and later systems (Hybrid/PBX mode only), messaging features generally do not work across a private network. They only work for extensions connected to the same system.

A user cannot turn a message light at a non-local dial plan extension off or on. Only an integrated VMI port can turn a message light on or off across a private network (Release 6.1 and later systems).

An operator cannot inspect the message status of an extension.

**Voice Messaging
Interface**

In Release 2.0 and later systems, when using the Return Call feature for a voice messaging system, a call is returned to the voice messaging system, not to the specific VMI jack that sent the message-waiting code.

Microphone Disable

At a Glance

Users Affected	Telephone users, DLC operators
Reports Affected	Extension Directory
Modes	All
Telephones	All MLX (except QCC)
System Programming	Enable or disable individual MLX telephone microphones: ■ Extensions→More→Mic Disable
Factory Setting	Enabled

Description

Microphone Disable can be assigned through system programming to any MLX telephone, except a Queued Call Console (QCC), to limit the use of the speakerphone. When the feature is assigned, the microphone does not function, but the speaker functions normally. A user can listen to calls or announcements over the speakerphone but must use the handset to respond.

For some features, such as Auto Dial, Last Number Dial, or Saved Number Dial, the system automatically selects a line and activates the speakerphone. When one of these features is used on a telephone with Microphone Disable assigned, the system selects the line and activates the speaker, but the microphone is muted automatically; the red LED next to the Mute button lights. To be heard, lift the handset. The Mute and Speaker LEDs go off.

Also, when group pages or voice-announced transfers are received on a telephone with Microphone Disable assigned, you can hear the announcement over the speakerphone, but the microphone is muted automatically. Lift the handset to speak to an inside caller who is either transferring a call or calling you through an SA Voice or ICOM Voice button. Microphone Disable is appropriate when speakerphones pick up too much background noise, or when they are needed by only some employees.

Considerations and Constraints

The LED next to the Mute button goes on whenever the speakerphone is activated. Pressing the Mute button does not turn off the LED or deactivate Microphone Disable.

If you press the Speaker button before lifting the handset, the system selects a line and you can dial a number. The microphone is muted, and you must lift the handset to speak to the person being called.

Telephone Differences

Queued Call Consoles

The microphone on a QCC cannot be disabled.

Other Telephones

Microphone Disable cannot be assigned to analog multiline telephones.

Microphone Disable cannot be assigned to single-line telephones.

Feature Interactions

Auto Dial, Last Number Dial, and Saved Number Dial	Pressing a programmed Auto Dial, Last Number Dial, or Saved Number Dial button turns on the speakerphone so you can hear the number being dialed. On an MLX telephone with the microphone disabled, however, you must lift the handset to talk once the call is answered.
HFAI	With the microphone disabled, you cannot use HFAI to respond to voice-announced calls. Pressing the HFAI button does not turn on the LED or activate the feature.
Last Number Dial	On an MLX telephone with the microphone disabled, pressing the programmed Last Number Dial button before lifting the handset turns on the speakerphone so you can hear the number being dialed. Once the call is answered, however, you must lift the handset to talk.
Paging	Calls made to speakerphone paging groups can still be heard over telephones whose microphones are disabled.
Transfer	Calls can be transferred with a voice announcement if your microphone is disabled, but you must lift the handset to talk.
Voice Announce	If you are on a telephone whose microphone is disabled, you can still hear a voice-announced call over the speakerphone. You must press the button with the incoming call and use the handset to talk to the caller.

Multi-Function Module

At a Glance

Users Affected	Telephone users, data users
Reports Affected	SMDR
Modes	All
Telephones	MLX telephones except QCC
Hardware	Tip/ring interface



WARNING:

RISK OF ELECTRICAL SHOCK: Follow all warnings and cautions.

ONLY a qualified technician should install, repair, or set options for an MFM. Do not touch the circuitry on the MFM. Touching the circuitry may result in component damage from electrostatic discharge.

Before installing the MFM, disconnect all line/trunk and/or power cords attached to the MLX telephone. This is to ensure that no hazardous voltages are present during assembly. Ringing voltage from the MFM attached to the MLX telephone can cause electrical shock if adjustments are made while the cords are connected.

Description

The Multi-Function Module (MFM) is an optional adapter installed inside an MLX telephone and used for connecting tip/ring or external alert devices. The MFM operates on one of the two communications channels assigned to the telephone; therefore, calls can be made to and from the device independently of the telephone. The communications channel is also used for the Voice Announce feature. Because of this, when a call is active at both the MLX telephone and the MFM device, the Voice Announce feature cannot be used to reach the MLX telephone user. Conversely, if the Voice Announce feature is being used to reach the MLX telephone user, calls cannot be made from the device connected to the MFM. In addition, if the Voice Announce feature is being used at the same time that a call is received at the MFM extension number, the caller hears ringing, and the device rings if it can. But the call to the MFM extension number cannot be answered until one of the communications channels is free (the MLX telephone user hangs up or the person calling the MLX telephone user hangs up).

Although each MLX extension jack used to connect an MLX telephone is assigned only one logical ID, the system automatically assigns two extension numbers—

one for the MLX telephone and one for the device connected to the MFM. Both extension numbers are assigned to the jack, whether or not an MFM is connected. Because a separate extension number is assigned, features and line/trunk access can be assigned to the MFM independently of the MLX telephone. See [“System Renumbering” on page 685](#) for details on specific extension numbers assigned.

The ringing patterns for devices connected to an MFM are similar to those of an MLX telephone for inside calls: two rings for outside calls; a ring and two beeps for priority ring or transfer return.

A switch on the MFM can be set for either of the following operations:

- Tip/ring interface
- Supplemental Alert Adapter (SAA)

Tip/Ring Interface

When an MFM is set for tip/ring interface operation, only dual-tone multifrequency (DTMF) tip/ring devices can be used to make and/or receive inside and outside calls. The following types of DTMF devices can be used:

- Single-line telephones
- Modems
- Fax machines
- Credit card verification terminals
- Cordless single-line telephones
- Speakerphones that emulate a tip/ring device
- Answering machines

Supplemental Alert Adapter

When an MFM is set for SAA operation, an external alert that requires a 48-VDC contact closure can be connected.

If the external alert is used to supplement the ringing for both inside and outside calls, the MFM should be assigned (through centralized telephone programming) as a Primary Individual Coverage receiver with the Ring Timing option of Immediate Ring. The MLX telephone can use Coverage On/Off to activate the alert. In addition, by specifying that both inside and outside calls or only outside calls are covered with the coverage arrangement, the sender (in this case the MLX telephone user) can specify that the device (the receiver) should ring for both inside and outside calls or only for outside calls.

If the external alert is used to supplement ringing only for calls received on personal lines (outside lines assigned to buttons), the same outside lines/trunks

and ringing options assigned to the MLX telephone should also be assigned to the MFM. In this arrangement, the MFM device does not ring when inside calls are received on an SA or ICOM button.

An external alert connected to an MFM set for SAA operation can be manually signaled, can serve as a calling group calls-in-queue alert, or can provide supplemental alerting for after-hours calls received in a Night Service group. Only a strobe or other light should be used as a calls-in-queue alert; if a bell is used, it rings continuously while the number of calls in the calling group queue exceeds the programmed threshold.

Programming Requirements

Although a device connected through an MFM may not have buttons, the system treats it as a multiline telephone with 34 buttons. In Hybrid/PBX mode, the system automatically assigns one SA Ring, one SA Voice, and one SA Originate Only button to the MFM. In Key mode, the system automatically assigns one ICOM Ring and one ICOM Voice button to the MFM. In Behind Switch mode, the system automatically assigns one ICOM Ring, one ICOM Voice, and one prime line button.



NOTE:

Do not attempt to enter extension programming from a device connected to an MFM. Program an MFM only through centralized telephone programming.

To ensure proper operation of a device connected through an MFM, the following should be performed through centralized telephone programming:

- Voice Announce should be disabled.
- SA or ICOM button assignments should be changed to one SA Ring or ICOM Ring, and either one SA Originate Only or one ICOM Originate Only button.
- Ringing/Idle Line Preference should be enabled.
- The Automatic Line Selection sequence should be set to the following:
 - SA Ring or ICOM Ring
 - SA Originate Only or ICOM Originate Only
 - In Key and Behind Switch modes, outside lines that make calls from the MFM device
 - In Behind Switch mode only, the prime line

When the Automatic Line Selection (ALS) sequence is set to select an SA or ICOM button, an outside line can be selected by dialing the Idle Line Access code (usually 9) in Key and Behind Switch modes or by dialing the

pool dial-out or ARS code in Hybrid/PBX mode. If ALS is set to select an outside line button before an SA or ICOM button, the device cannot be used to make inside calls (inside calls can be received only).

- Ring Timing options should be set to No Ring for each outside line on which calls are not to be received.
- When the device is used only on personal lines for supplementary answering (such as an answering machine) or ringing (such as an external alert) and lines/trunks are assigned to or removed from the associated MLX telephone, the lines/trunks should also be assigned to or removed from the MFM.
- When the device is used for both inside and outside calls to supplement ringing (external alert) or to answer or screen calls (answering machine), calls can be redirected to the device by assigning a Primary Cover, Secondary Cover, Group Cover, or Shared SA button. In addition, an MLX telephone user can activate Forward and Follow Me to redirect incoming calls to the device. However, Coverage should not be used simultaneously with Forward and Follow Me.



NOTE:

Forward and Follow Me (including Remote Call Forwarding) and Privacy are not recommended, because there are no LEDs to indicate when the features are active.

Considerations and Constraints

When both the MLX telephone and the device connected to an MFM are in use, the Voice Announce feature cannot be used to reach the MLX telephone. Voice Announce interferes with data calls made to a data workstation including an MFM.

The tip/ring or SAA interface is selected by setting pin straps in the MFM. Only authorized technicians can install or set options in the MFM.

When Ringing/Idle Line Preference is turned on for an MFM and Automatic Line Selection is set to an outside line/trunk, inside calls cannot be made and features cannot be used. Both inside and outside calls can be received.

Calls are sent independently to the MLX telephone and its associated MFM. The following features can be employed when a user wants calls to be received at both the MLX telephone and the device connected to an MFM:

- Cover buttons
- Shared SA buttons
- Buttons assigned the same outside lines
- Forward and Follow Me
- Transfer

An MFM can be assigned as a calling group delay announcement device or as a calls-in-queue alert for a calling group queue.

Tip/ring devices connected to an MFM should not be used with Call Management System (CMS).

Features and tip/ring applications that require a switchhook flash for operation (such as Messaging 2000) cannot be connected through an MFM because the system ignores the switchhook flash sent by the device.

Some answering machines have the built-in ability to disconnect when someone picks up a line the machine has already answered. However, when a Shared SA button or a shared personal line is assigned to the MFM, the device cannot detect when a line is picked up by the sharing user. Therefore, if such an answering machine is connected to the MFM, the machine does not automatically disconnect when someone picks up the shared lines that the machine has already answered. Similarly, if the MFM extension is a Primary Coverage receiver for the MLX telephone or has the MLX extension's calls forwarded to it, the machine does not automatically disconnect when the telephone user picks up a call.

When programming, you cannot select an MFM by slot and port (*[sspp]) or by logical ID (#[nnn]).

A digital data or video workstation with an MLX telephone must not include an MFM.

Mode Differences

Hybrid/PBX Mode

When Ringing/Idle Line Preference is turned on and Automatic Line Selection is set to select an SA button, an outside line can be selected by dialing the pool dial-out or ARS code.

Key and Behind Switch Modes

When Ringing/Idle Line Preference is turned on and Automatic Line Selection is set to select an ICOM button, an outside line can be selected by dialing the Idle Line Access code (usually 9).

Telephone Differences

Direct-Line Consoles

An MFM in a Direct-Line Console (DLC) serves only as another extension, without the characteristics of an operator extension.

Queued Call Consoles

An MFM cannot be connected to a Queued Call Console (QCC).

Other Telephones

An MFM can be installed only in MLX telephones; it cannot be used with analog multiline telephones.

An MFM cannot be used with a digital communications device or videoconferencing system.

Single-Line Telephones

A single-line telephone or other type of tip/ring device up to 1,000 feet away can be connected to an MFM and used to make and receive inside and outside calls.

A single-line telephone connected to an MFM cannot use the Pickup, Conference, Hold, HotLine, or Transfer features.

Feature Interactions

Automatic Line Selection

When an MFM is installed in an MLX telephone, the ALS sequence for the MFM should be set to select SA Ring or ICOM Ring, then SA Originate Only or ICOM Originate Only, then outside lines (or the prime line in Behind Switch mode) assigned to the MFM. Ringing/Idle Line Preference should be on for an MFM.

Callback

Both Automatic and Selective Callback can be used from an MFM. A callback call, however, cannot be manually canceled because the MFM does not recognize the switchhook flash produced by pressing the Drop button.

Conference	The Conference feature cannot be used on the MFM because the system ignores the switchhook flash sent by the MFM.
Coverage	<p>An MFM can be a sender or a receiver for Individual or Group Coverage. This allows an MLX telephone user to screen calls by using an answering machine connected to the MFM or to supplement ringing with an external alert connected to the MFM. A sender can use Coverage Off to prevent calls from being sent to an answering machine.</p> <p>Calls can be redirected to the MFM by assigning a Primary Cover, Secondary Cover, or Group Cover button. Coverage and Forward and Follow Me should not be used simultaneously.</p>
Digital Data Calls	An MLX telephone at a digital data workstation must not include an MFM.
Do Not Disturb	Do Not Disturb is not recommended, because the device connected to the MFM does not have an LED to indicate when the feature is active.
Fax Extension	A single-line telephone with a Message LED that is connected to an MFM can receive message-waiting indications, but not a stutter dial tone.
Forward and Follow Me	An MLX telephone user can activate Forward and Follow Me to redirect incoming calls to an MFM device. Coverage, however, should not be used simultaneously with Forward and Follow Me.
Group Calling	An MFM can be assigned as a calling group delay announcement device or as a calls-in-queue alert for a calling group queue.
Hold	A single-line telephone connected to an MFM cannot put a call on hold because the MFM cannot send a switchhook flash.
Messaging	A single-line telephone with a Message LED connected to an MFM can receive message-waiting indications.
HotLine	A single-line telephone connected to an MFM cannot be used as a HotLine.
Night Service	An MFM can be a member of a Night Service group. An external alert connected to the MFM in SAA operation, when assigned to a Night Service group, can provide supplemental ringing for after-hours calls.
Paging	An MFM should not be a member of a speakerphone paging group.
Park	At an MFM, a call cannot be parked, but a parked call can be picked up by another user.
Personal Lines	If an MFM device is used to answer calls or provide supplementary ringing for its associated MLX telephone, any personal lines removed from the telephone should also be removed from the MFM. When the device connected to an MFM (a modem, for example) requires a personal line to make and/or receive calls, a personal line should be assigned.
Privacy	Privacy should not be used on an MFM (unless Privacy is to stay on at all times, as at a data workstation), because there is no LED to indicate whether Privacy is on or off.

Recall/Timed Flash	An MFM cannot send a timed flash. As a result, a single-line telephone or other device connected to an MFM cannot use Recall.
Ringling Options	At an MFM, lines that do not receive calls should be set to No Ring.
Service Observing	In Release 6.1 and later systems, voice calls to a telephone connected to an MFM can be observed; data and video calls cannot be observed.
Signal/Notify	When set for supplemental alert adapter operation, a MFM can receive a signal, but cannot send one. When set for tip/ring operation, an MFM cannot receive a signal.
SMDR	An MFM is treated as an MLX telephone on SMDR reports.
System Access/ Intercom Buttons	When the device is used for both inside and outside calls to supplement ringing (external alert) or to answer or screen calls (answering machine), calls can be redirected to the device by assigning a Shared SA button.
Transfer	Calls cannot be transferred from an MFM, because an MFM cannot send a switchhook flash.
Voice Announce	Voice Announce interferes with data calls made through a device attached to an MFM.

Music-On-Hold

At a Glance

Reports Affected	System Information (SysSet-up)
Modes	All
Telephones	All
System Programming	Designate the Music-On-Hold extension jack: ■ AuxEquip→MusicOnHold
Maximums	1 Music-On-Hold extension for each system

Description

Music-On-Hold can provide music or recorded information to an outside or private-network (Release 6.0 and later systems only) caller when the following features are used:

- Conference (while on hold)
- Group Calling (while waiting in the calling group queue for a busy extension after listening to the delay announcement)
- Hold



NOTE:

The music source or recorded announcement device must be connected to a ground-start or loop-start line/trunk jack programmed for Music-On-Hold. If Music-On-Hold is used without connecting a music source properly, an outside caller hears nothing.

In addition, Music-On-Hold can be programmed for the Transfer Audible feature as an alternative to ringback in the following feature interactions:

- Camp-On
- Hold, Transfer, and Conference for single-line telephones
- Park
- Transfer
- Private network calls (Release 6.0 or later systems only)

If transfer audible is programmed, what callers hear is described in [Table 29](#).



NOTE:

The information in Table 30 is for calls handled by the local MERLIN LEGEND System. For complete information about the operation of Music-On-Hold for private-network calls, refer to the *Network Reference*.

Table 29. Call Types and Transfer Audible

Type of Call	Music-On-Hold Programmed as Transfer Audible	Ringback Programmed as Transfer Audible: No MOH
Outside call directly dialed into calling group that has delay announcement device(s)	Ringing before announcements ¹ play, then Music-On-Hold between announcements until call leaves the queue and is delivered to an agent; ringing until agent answers.	Ringing before announcements play, then special ringing until call leaves the queue and is delivered to an agent; ringing until agent answers.
Outside call directly dialed into calling group that has no delay announcement device	Ringing until agent answers.	Ringing until agent answers.
Outside call transferred to a calling group that has delay announcement device(s)	Music-On-Hold (both before and after announcements ¹ play) until call leaves the queue and is delivered to an agent; ringing until agent answers.	Special ringing (both before and after announcements play) until call leaves the queue and is delivered to an agent; ringing until agent answers.
Outside call transferred to calling group that has no delay announcement device	Music-On-Hold until call leaves the queue and is delivered to an agent; ringing until agent answers.	Special ringing until call leaves the queue and is delivered to an agent; ringing until agent answers.
Outside call parked by user or operator ²	Music-On-Hold until call is picked up.	Ringing until call is picked up.
Outside call that is camped-on to an extension ¹	Music-On-Hold until call is answered.	Ringing until call is answered.
Outside call transferred with consultation to a non-group extension	Music-On-Hold (during consultation) until transfer is completed; ringing until call is answered.	Ringing until call is answered.

Table 29. Call Types and Transfer Audible — Continued

Type of Call	Music-On-Hold Programmed as Transfer Audible	Ringback Programmed as Transfer Audible: No MOH
Outside call transferred without consultation to an extension other than a calling groups ¹	Manual Completion – Music-On-Hold during dialing of destination, then ringing. Automatic Completion – Ringing.	Manual Completion – Ringing until call is answered. Automatic Completion – Ringing until call is answered.
Inside caller	Ringing or special ringing.	Ringing or special ringing.

- 1 Up to ten primary and one secondary delay announcement devices are available in Release 5.0 and later systems only. See [“Group Calling” on page 350](#).
- 2 If either the Park Return Timer or the Camp-On Return Interval expires before the parked or camped-on call is answered, the call returns to the extension that parked or camped on the call, and the outside caller continues to hear Music-On-Hold until the call is picked up.

Considerations and Constraints

Music-On-Hold is not provided to inside callers.

Music-On-Hold is never heard by callers in the Queued Call Console queue.

Direct Inward Dialing (DID) and tie line/trunk jacks cannot be used for Music-On-Hold. A line/trunk jack designated for Music-On-Hold cannot be grouped in a pool.

During programming of a line/trunk jack for Music-On-Hold, the entire system is forced idle.

In Release 6.0 and later systems (Hybrid/PBX mode only), non-local dial plan calls carried over private network trunks are treated by the system as outside calls. If Music-On-Hold is programmed, callers hear Music-On-Hold as for an outside call.

If you use equipment that rebroadcasts music or other copyrighted materials, you may be required to obtain a copyright license from or pay fees to a third party such as the American Society of Composers, Artists, and Producers (ASCAP) or Broadcast Music Incorporated (BMI). You can purchase a Magic On Hold[®] system, which does not require such a license, from Lucent Technologies.

Feature Interactions

Callback	An outside caller waiting in the callback queue hears Music-On-Hold.
Camp-On	When Camp-On is used to complete the transfer of an outside call, the caller hears Music-On-Hold until the call is answered if the transfer audible is set to Music-On-Hold. See Table 29 for more information.
Conference	If the first participant put on hold for a conference call is an outside caller, that caller hears Music-On-Hold until the second participant is added.
Forward and Follow Me	In Release 6.0 and later systems where extensions are using the Centrex Transfer via Remote Call Forwarding feature, do not program Music-On-Hold as the transfer audible. If Music-On-Hold is programmed in this case, a caller being transferred hears a click, three seconds of Music-On-Hold, a second click, then silence for about 10 seconds, then ringback or a busy tone from the central office. This can confuse callers, who may then hang up.
Group Calling	Outside callers waiting in calling group queues hear Music-On-Hold (if programmed).
Night Service	A line/trunk jack programmed for Music-On-Hold cannot be assigned to a Night Service group.
Park	A parked caller hears Music-On-Hold.
Pools	Line/trunk jacks used for Music-On-Hold cannot be assigned to pools.
Personal Lines	Line/trunk jacks used for Music-On-Hold cannot be assigned as personal lines.
Remote Access	A remote access user who is waiting for a busy line/trunk pool or extension hears Music-On-Hold.
Transfer	If the system is programmed for Music-On-Hold, music is played only during the period before a transfer is completed by the extension originating it. The caller hears music when the Transfer button is pressed and when the extension number is dialed. When the transfer originator presses the Transfer button a second time or hangs up, the caller hears ringing. If the transfer uses automatic completion to a non-calling group extension, the outside caller hears ringing.
UDP Features	<p>In Release 6.0 and later systems (Hybrid/PBX mode only), Music-On-Hold sources cannot be shared by networked systems.</p> <p>Calls between systems in a private network are treated as outside calls; therefore, callers hear Music-On-Hold as though they were outside callers.</p>

Night Service

At a Glance

Users Affected	Telephone users, operators, data users
Reports Affected	Extension Information, Night Service Information
Modes	All
Telephones	All
Programming Code	*39
Feature Code	39
MLX Display Label	Night Srvc [Night]
System Programming	<p>Assign or remove extensions to or from Night Service group:</p> <ul style="list-style-type: none"> ■ NightSrvce→GroupAssign→Extensions <p>In Release 4.1 and later systems, assign or remove outside lines to or from Night Service group:</p> <ul style="list-style-type: none"> ■ NightSrvce→GroupAssign→Lines <p>Select Night Service with Outward Restriction by assigning a password:</p> <ul style="list-style-type: none"> ■ NightSrvce→OutRestrict <p>In Release 4.1 and later systems, enable or disable Coverage Control option:</p> <ul style="list-style-type: none"> ■ NightSrvce→CoverContrl <p>Add or remove telephone numbers from Night Service Emergency Allowed List:</p> <ul style="list-style-type: none"> ■ NightSrvce→Emergency <p>Assign telephones to Exclusion List (password not required):</p> <ul style="list-style-type: none"> ■ NightSrvce→ExcludeList <p>Select start time and stop time for each day of the week for Night Service with Time Set:</p> <ul style="list-style-type: none"> ■ NightSrvce→Start/Stop→Day, Hr, Min
Factory Settings	
Outside lines assigned to Night Service Group	None (4.1 and later systems only)
Coverage Control	Disabled (4.1 and later systems only)
Time Set	Disabled
Outward Restriction	Disabled

Maximums

Night Service groups	8 (one for each operator)
Number of extensions in Night Service group	Unlimited except by system capacity
Number of outside lines in Night Service group	Unlimited except by system capacity (4.1 and later systems)
Calling group extension for each Night Service group	1 (Release 2.0 and later systems)
Night Service groups for each extension	Unlimited
Emergency telephone numbers	10
Digits for each telephone number	12
Extensions on Exclusion List	Unlimited
Password	4 digits (0–9)

Description

Night Service provides optional after-hours operation that can be programmed in combination with the following features:

- Night Service with Group Assignment
- Night Service with Outward Restriction
- Night Service with Time Set
- Night Service with Coverage Control (Release 4.1 and later systems only)



NOTE:

The term *after-hours* is only used for convenience. Night Service can operate at any time it is activated and is intended for use outside of normal business hours.

Operators can activate or deactivate Night Service by using a Direct-Line Console (DLC) or a Queued Call Console (QCC). To activate or deactivate Night Service, an operator presses the programmed Night Service button. (This function is performed automatically when the Time Set function, described later in this topic, is used.) If the Night Service with Outward Restriction option is programmed, the green LED flashes when a DLC operator presses the programmed Night Service button. The operator must enter the assigned password within 60 seconds to activate or deactivate Night Service. When Night Service is activated, the green LED next to the programmed Night Service button lights. When the feature is deactivated, the green LED turns off.

Night Service Group Assignment

Each Night Service group is associated with either an individual QCC (in Hybrid/PBX mode) or an individual DLC through system programming.

A Night Service group can include the following types of members:

- Any type of extension
- One calling group (Release 2.0 and later) for each Night Service group
- Calling group with one non-local member (Release 6.1 and later)
- In Release 4.1 and later systems, outside lines must be assigned to Night Service groups in order for calls received on these lines to receive Night Service treatment. The system manager can assign the following types of outside lines to Night Service groups:
 - Loop-start lines
 - Ground-start lines
 - NI-BRI B-channels
 - PRI B-channels that are routed by line appearance
 - Automatic incoming tie trunks

The following types of outside lines *cannot* be assigned to Night Service groups:

- DID (Direct Inward Dial) trunks
- Dial-in tie trunks
- PRI B-channels that are routed by dial plan
- Line/trunk jacks programmed for Alarm, Music-On-Hold, or Paging
- Unequipped line/trunk jacks
- In Release 6.0 and later systems (Hybrid/PBX mode only), Night Service group members and operators must all be local system users. Private trunks should not be assigned to Night Service groups.

In Release 4.1 and later systems, during Night Service operation, calls received on lines assigned to a Night Service group ring at the Night Service destination for the group (an extension or calling group). A line need not be assigned to an operator position in order to receive Night Service coverage to a calling group. Lines that are not assigned to a Night Service group, whether or not they appear at operator consoles, do not receive Night Service treatment.

In Release 4.0 and prior systems, when an operator associated with a Night Service group activates Night Service or when the Time Set option turns on Night Service operation automatically, any calls received on lines/trunks programmed to ring at individual operator consoles ring immediately at all available extensions assigned to the group.



SECURITY ALERT:

Avoid programming a remote access line as a destination for Night Service for any published telephone number. Professional toll-fraud criminals scan telephone directories for published local and 800 telephone numbers. Using these numbers, they attempt to gain access to the system, then may use such features as Remote Access to reach outside facilities from within the system. For additional information about toll fraud, see [Appendix A, "Customer Support Information."](#)

An extension in a Night Service group is considered unavailable, and a Night Service call does not ring at that extension when any of the following situations occur:

- A telephone is in extension or system programming mode.
- A user with an MLX display telephone is using Alarm Clock or Directory features.
- A telephone is busied-out for maintenance or system programming.
- All SA or ICOM buttons are in use.
- A single-line telephone user is on a call.



NOTE:

Up to eight Night Service groups can be created, one for each operator. There is no limit to the number of extensions assigned to each group. Each extension can be assigned to more than one group.

Night Service with Outward Restriction

Night Service with Outward Restriction prevents unauthorized after-hours use of extensions. When this option is programmed, only authorized operators can activate and deactivate Night Service, and only authorized users can place calls.



NOTE:

In Release 6.0 and later systems (Hybrid/PBX mode only), Night Service outward restriction does not apply to non-local dial plan calls.

A system operator must enter a password to activate or deactivate Night Service. When one operator activates or deactivates Night Service this way, all consoles are put into Night Service. If Night Service groups are assigned, Night Service is activated or deactivated for all groups and cannot be activated or deactivated independently for each group. When the Night Service feature is activated, enter a password before making a non-emergency outside call. When you have entered the correct password, the system checks for calling restrictions assigned to your extension before allowing the call.

A Night Service Emergency Allowed List of emergency numbers can include up to 10 numbers, each with no more than 12 digits. Users who do not know the Night Service password can dial only the numbers on the list; calls to numbers not on the list do not go through unless the caller enters a password.

One Exclusion List for Night Service can be created to exempt specific extensions from the password requirement. An unlimited number of extensions can be assigned to the list. Normal calling restrictions (if any) assigned to the extension, however, are still in effect. Unrestricted extensions on the list are not protected against unauthorized after-hours use.

HotLine extensions cannot dial the Night Service Emergency numbers or the Night Service password.

Night Service with Time Set

When Night Service with Time Set is programmed, the system automatically activates Night Service on all operator consoles at a specified time of day on specified days of the week. A different time of day to activate or deactivate Night Service can be programmed for each day of the week. Operators can still override the timer and turn Night Service on and off manually. If one system operator overrides the timer, Night Service is activated or deactivated on *all* consoles.

Night Service also can be activated through system programming for special conditions, such as a midweek holiday.

Night Service with Coverage Control

In Release 4.1 and later systems, system managers can set Night Service, in combination with any other Night Service options, to control the status of programmed Coverage VMS Off buttons at Night Service member extensions. This allows the system manager to turn on the voice messaging system (VMS) coverage of outside calls automatically.



NOTE:

In Release 6.0 and later systems (Hybrid/PBX mode only), Night Service with Coverage Control does not work for non-local dial plan extensions.

A coverage sender with a VMS calling group assigned as a receiver can program a Coverage VMS Off button to prevent outside calls from being sent to voice mail. When Coverage VMS Off is inactive (button is unlit), inside and outside calls go to voice mail. When the programmed feature is active (button is lit), only inside calls go to voice mail.

The system manager can enable Night Service with Coverage Control through system programming. The option then automatically activates Coverage VMS Off

buttons at member extensions when Night Service operation begins. When Night Service goes off, the Coverage Control option automatically deactivates member extensions' Coverage VMS Off buttons so that outside calls are no longer covered by voice mail.

A user at a member extension can press the Coverage VMS Off button to change its status, regardless of Night Service operation. When the next Night Service transition takes place, all programmed Coverage VMS Off buttons reflect the current Night Service status. The most *recent* event, whether it is a Night Service transition or a user button-press, governs the status of the Coverage VMS Off buttons.

Considerations and Constraints

A Direct Inward Dial (DID) call to any member of a Night Service group rings at all group members' telephones.

If an extension assigned to a Night Service group has the same outside line (personal line) as an operator console, calls to this line ring immediately at each extension, even if the personal line on the telephone is programmed for Delay Ring or No Ring. If the extension does not have the outside line assigned, the call rings on an SA or ICOM button.

When Night Service is deactivated by an operator or automatically by the system, extensions are reset to their programmed Ring Timing options.

When a feature code is used to activate or deactivate Night Service, and Outward Restriction is programmed, a DLC operator does not hear an error tone if an invalid password is entered. Unless a Night Service button is programmed, an operator cannot determine whether Night Service is active.

When both the Night Service with Outward Restriction and Night Service with Time Set options are programmed, the system imposes restrictions automatically.

When Night Service with Outward Restriction is used, an operator must enter a password to manually activate or deactivate Night Service.

When Night Service with Outward Restriction and/or Night Service with Time Set are programmed, Night Service is activated or deactivated for all operator consoles. If Night Service groups are also programmed, Night Service cannot be activated or deactivated separately for each group.

When Night Service with Outward Restriction is activated and a user with a restricted extension presses a dialpad button while on a call, the call is disconnected, the user hears a fast busy signal, and the line/trunk is released. When the dialpad is used, the system assumes that the user is trying to make an

outside call, which is not allowed because of the Night Service restriction assigned to the extension.

Operators can override Night Service with Time Set and turn Night Service on or off manually.

Night Service with Time Set can be deactivated through system programming for special conditions such as a midweek holiday.

An answering machine connected to an 012 (T/R) module or 016 (T/R) module can be set up as a member of a Night Service group to automatically answer after-hours calls. External alerts, such as strobes, bells, or chimes, can be connected either to an analog multiline telephone by using a Supplemental Alert Adapter, or to an MLX telephone by using a Multi-Function Module (MFM) that is a member of a Night Service group. The external alert sounds or lights when a Night Service call comes in to that telephone.

Changing the system time while in Night Service mode deactivates Night Service; Night Service then must be reactivated manually.

Night Service with Coverage Control controls voice messaging system coverage only and has no effect on other forms of coverage, such as Individual Coverage or other types of Group Coverage. When the option is disabled, Night Service does not affect programmed Coverage VMS Off buttons.

If a user with a programmed Coverage VMS Off button activates or deactivates Coverage by pressing the button on his or her telephone, the next transition to Night Service does not necessarily toggle the button to the opposite status. Instead, when Night Service goes on or off, the button assumes the same active or inactive state that it would have if no manual button-press had taken place. The most *recent* event, whether it is a manual button-press or an automatic change set by the Coverage Control option, determines the active/inactive state of the programmed Coverage VMS Off button.

Telephone Differences

Direct-Line Consoles

A DLC operator also can activate Night Service by pressing the Feature button and dialing 39. When a feature code is used to activate or deactivate Night Service and Outward Restriction is programmed, the DLC operator does not hear an error tone if an invalid password is entered and, unless a Night Service button is programmed, cannot determine whether Night Service is active.

On a system with 29 or fewer lines, a Night Service button is factory-assigned to analog DLCs with 34 buttons or more. On a system with more than 29 lines, the

Night Service button is not factory-assigned; instead, line 31 is assigned. The Night Service button is not a fixed feature and can be assigned to any available button on either an analog or MLX DLC.

Queued Call Consoles

The Night Service button is factory-assigned as a fixed feature on a QCC.

In Release 4.1 and later systems, if an outside line is assigned to more than one QCC Night Service group and only one QCC operator activates Night Service, incoming calls on the outside line ring on extensions programmed as members of the Night Service group associated with the operator.

In Release 4.0 and prior systems, if more than one QCC operator is assigned to receive calls on an individual outside line, Night Service must be activated at all assigned positions before calls on the line/trunk ring on extensions programmed as members of the Night Service group. If Night Service is not activated by one of the QCCs programmed to receive the calls, after-hours calls ring at that position and do not receive Night Service coverage.

When Night Service is on, unassigned DID extension and LDN (operator) call types ring into the QCC queue. If these call types are programmed not to go to the QCC queue, the caller hears an error tone when Night Service is off. However, when Night Service is on, these call types still ring into the QCC queue, regardless of programming.

When multiple Night Service calls are received in the QCC queue at the same time and none of the calls are answered by a Night Service group member—all group member SA or ICOM buttons are busy—new calls are sent to the QCC queue and can be answered only by a QCC operator. To avoid this situation, all outside lines assigned to ring on the QCCs should be assigned as personal lines on at least one group member's extension.

Other Multiline Telephones

To make a call when Night Service with Outward Restriction is assigned on a multiline telephone, before lifting the handset, press the Hold button and dial the password. When you have entered the correct password, lift the handset and make the outside call. Night Service password entry is not supported on MDC 9000 or MDW 9000 telephones.

Single-Line Telephones

On Single-line telephones, you cannot make outside calls when Night Service with Outward Restriction is activated.

Feature Interactions

- Alarm** A line/trunk jack programmed as a maintenance alarm port cannot be assigned to a Night Service group.
- Authorization Code** An authorization code can be used when Night Service is activated. For Night Service with Outward Restriction, you must enter a valid password before entering an authorization code.
- Automatic Route Selection** When Night Service with Outward Restriction is programmed, you must enter the password before dialing the ARS dial-out code, unless either the extension is assigned to an exclusion list or the number is on an emergency numbers list.
- Caller ID** Caller ID information appears on the display whether or not Night Service has been activated.
- Calling Restrictions** For Night Service with Outward Restriction, a Night Service Emergency Numbers List must be created to include emergency numbers that can be dialed from any extension without dialing the password. Any restrictions for an extension assigned to the Exclusion List continue in effect when Night Service is activated.
- Centralized Voice Messaging** A VMS can be placed into Night Service only by the system on which it resides. For Release 6.1 and later systems, however, calls coming in from a remote MERLIN LEGEND System are handled by Night Service when the local VMS switches to Night Service.
- Coverage** When the system manager enables the Coverage Control option, a transition into Night Service operation (either by pressing the Night Service button at an operator's console or through the Time Set feature) automatically deactivates all programmed Coverage VMS Off buttons (LED is off) at extensions in the Night Service group. This allows calls to go to voice messaging system coverage at night.
- When the system is taken out of Night Service—either by a press of the Night Service button at an operator's console or through the Time Set option—the Coverage Control option automatically activates all programmed Coverage VMS Off buttons, turning the LED on at extensions in the Night Service group. Outside calls no longer go to the voice messaging system.
- A user at the extension can override the Night Service with Coverage Control option by pressing the programmed Coverage VMS Off button at any time.
- Digital Data Calls** If a digital communications device or videoconferencing system is a member of a Night Service group, voice calls to the Night Service group do not ring at these extensions. Data or video calls *do* ring, and 2B data calls can be established. If there are two or more 2B data extensions receiving Night Service calls, however, the two 1B data calls that form a 2B data call may be directed to different extensions, instead of the same one, during Night Service operation.

- Display** If a system operator must enter a password to turn Night Service on and off, the display prompts the operator for the password. No message is displayed either when an operator activates Night Service by using a feature code or when Night Service is off.
- If an MLX display telephone is in test mode and a Night Service call arrives, the call rings at the telephones. Calling information, however, is not displayed until the Home button is pressed.
- Forward and Follow Me** When an extension is a member of a Night Service group and Night Service is activated, calls received at the extension are forwarded to extensions by using Forward and Follow Me, but are not forwarded to outside or non-local telephone numbers when Remote Call Forwarding is used.
- In Release 6.1 or later systems (Hybrid/PBX mode only), if the operator in charge of Night Service forwards calls to an outside number or a non-local extension, only calls received on lines to which the operator is assigned as the principal owner are forwarded. All other calls are not forwarded.
- Group Calling** In Release 2.0 and later systems, a calling group can be a Night Service group member. If a calling group is used as a Night Service member, no other calling groups or extensions are allowed to be Night Service members.
- In Release 6.1 and later systems (Hybrid/PBX mode only), a calling group receiving Night Service calls may contain a non-local extension as its only member.
- HotLine** HotLine extensions (Release 5.0 and later systems) can be members of Night Service groups. If a HotLine extension dials an outside call and Night Service with Outward Restriction is on, either the HotLine extension number must be in the Night Service Exclusion List or the number it dials must be on the Night Service Emergency List.
- Multi-Function Module** An MFM can be a member of a Night Service group. An external alert connected to the MFM in Supplemental Alert Adapter (SAA) operation, when assigned to a Night Service group, can be used for supplemental ringing for after-hours calls.
- Music-On-Hold** A line/trunk jack programmed for Music-On-Hold cannot be assigned to a Night Service group.
- Paging** A line/trunk jack programmed as a Loudspeaker Paging port cannot be assigned to a Night Service group.
- Personal Lines** If the voice mail calling group is assigned as a member of a Night Service group, incoming lines receive Automated Attendant treatment. When a call is answered by the Night Service group, ringing does not occur at an extension with that personal line and the Night Service coverage is used instead of the principal user's coverage.

- Pickup** By using Pickup, a user at another extension can answer a call ringing at a Night Service group extension.
- Primary Rate Interface and T1** A PRI B-channel can be assigned to a Night Service group if the Routing by Line Appearance option is assigned to the B-channel group. If routing by dial plan is assigned to the B-channel group, the B-channels in that group cannot be assigned to Night Service groups.
- Remote Access** in Release 4.1 and later systems, when shared remote access is assigned to an outside line that belongs to one or more Night Service groups, incoming calls on that line receive remote access treatment when Night Service is activated on *any* operator position.
- In Release 4.0 and earlier systems, when shared remote access is assigned to a line/trunk, incoming calls on that line/trunk receive remote access treatment only when Night Service is activated on *all* operator positions that receive calls on the line/trunk. When a call is received on a line/trunk assigned for shared remote access and Night Service is not activated, the call rings at the assigned telephone, operator console, or calling group.
- Ringling Options** When Night Service is turned on, calls received at a Night Service group member's telephone ring immediately, even if the line buttons are programmed for Delay Ring or No Ring. When Night Service is turned off, extensions return to their programmed Ring Timing options.
- Service Observing** In Release 6.1 and later systems, if a Night Service call is answered at an extension in a Service Observing group, the call can be observed.
- System Access/ Intercom Buttons** Night Service calls override any Ring Timing options (Delay Ring or No Ring) programmed for SA buttons and ring immediately. Shared SA buttons flash and do not ring.
- UDP Features** In Release 6.0 and later systems (Hybrid/PBX mode only), if Night Service is programmed with outward restriction, the restriction does not apply to non-local dial plan calls. Exclusion lists apply only to the local system's extensions and do not apply to UDP calls.
- Transitions into and out of Night Service must be made locally. For example, an operator cannot turn on Night Service at a remote system.
- During Night Service operation, a user can call into a shared remote access trunk and use remote access to reach non-local extensions.
- During Night Service operation, an intersystem call to a member of a Night Service group rings at all member extensions.
- Private trunks should not be assigned to a Night Service group.

Features
Notify

469

Notify

See [“Signal/Notify” on page 645.](#)

Paging

At a Glance

Users Affected	Telephone users, operators
Reports Affected	Dial Plan Information, Extension Information, Group Paging, System Information (SysSet-up)
Modes	All
Telephones	All
Programming Code	*22 + group or Page All ext. no.
MLX Display Labels	Group Page [GrpPg] Loudspkr Pg [LdsPg]
System Programming	Assign telephones to paging groups: <ul style="list-style-type: none"> ■ Extensions→More→Group Page Designate a loop-start or ground-start/loop-start line/trunk jack as a paging jack: <ul style="list-style-type: none"> ■ AuxEquip→Ldspkr Pg
Maximums	
Groups	6 speakerphone paging groups
Telephones	1 Page All group
Line/trunk Jacks	10 in each paging group (see Note below) 3 programmed as loudspeaker paging ports
Factory Settings	
Extensions	793–798 (speakerphone paging groups) 799 (Page All group)



NOTE:

Each extension can belong to up to seven paging groups (for example, each of the six speakerphone paging groups and the Page All group).

Description

Paging allows users to broadcast announcements using their telephones. There are two types of paging: Speakerphone Paging and Loudspeaker Paging. Speakerphone Paging allows broadcasting either to specific individuals or to designated groups. Loudspeaker Paging allows broadcasting to specific groups or to all extensions, depending on whether or not the loudspeaker system is a multizone paging system.

Speakerphone Paging

An announcement made by using Speakerphone Paging is heard on telephones with built-in speakerphones (except single-line telephones with built-in speakerphones) or speakerphone adjuncts. Speakerphone Paging can be directed to an individual telephone, to groups, or to all speakerphones.

Individual Paging

An SA Voice or ICOM Voice button on a multiline telephone is used for Speakerphone Paging directed to an individual extension (also called *voice-announced* inside calling). Select the voice button, and then dial the extension number of the telephone to receive the voice-announced call. If the voice announcement can be made, the caller hears a tone and then speaks into the handset.

The person called hears the announcement over the speakerphone, unless one of the following conditions exists:

- The telephone does not have a speaker.
- The person called is using the speakerphone.
- The person called is on an analog multiline telephone, and the system manager has removed Voice Announce from the extension.
- The person called is busy on an MLX telephone and has Voice Announce to Idle Only on (Release 7.0 or later systems).
- The person called has turned off Voice Announce.
- The person called is using Do Not Disturb.
- The person called is a QCC operator.
- The person is active on a call on an ETR or MLS telephone

When any of these conditions exists, the caller hears ringback if the person called has an available SA or ICOM button. The caller hears a busy, call-waiting, or callback tone when the person called is busy on all SA or ICOM buttons. If the person called is using Do Not Disturb, the caller hears a busy signal.

Speakerphone Paging to an individual extension is considered an inside call. The green LED next to an available SA or ICOM button flashes to indicate an incoming call. The person called either can use the Hands-Free Answer on Intercom (HFAI) feature to talk to the caller or can pick up the handset to speak.

Group Paging

Group Paging directs Speakerphone Paging either to a selected group of extensions, such as a department or work area, or to all extensions in the system, except QCC operator positions.



NOTE:

The system manager can program a QCC Call button to allow voice-announced calling, but a QCC cannot receive speakerphone pages.

The system automatically reserves extension numbers 793 through 798 for the first six speakerphone paging groups. Up to 10 extensions can be assigned to each speakerphone paging group. The seventh speakerphone paging group is called the Page All group and is factory-set to page all extension numbers. The system automatically reserves extension number 799 for the Page All group. An extension can belong to up to seven speakerphone paging groups (including the Page All group).

When the extension number for a speakerphone paging group is dialed by using an SA or ICOM button, the announcement over speakerphones is heard on all telephones assigned to the group. If the extension dialed is for the Page All group, the announcement is heard on speakerphones throughout the system. A speakerphone paging group member does not hear a group page if one of the following conditions exists:

- The telephone has no speakerphone.
- The paging group member is using the speakerphone.
- The paging group member is on an analog multiline telephone, and the system manager has removed Voice Announce from the extension.
- The paging group member is busy on an MLX telephone and has Voice Announce to Idle Only on (Release 7.0 or later systems).
- The paging group member has turned off Voice Announce.
- The paging group member is either in programming mode or testing the telephone.
- The paging group member has an analog multiline telephone and is in extension programming. (Speakerphone pages are received on analog multiline telephones in test mode.)
- The paging group member is using Do Not Disturb.
- The paging group member is active on a call on an ETR or MLS telephone.

When a group member does not hear the announcement for any of these reasons, the caller is not notified unless all extensions in the group cannot hear the page, in which case the caller hears a busy signal.

The people being paged can listen only to the page over the speakerphone and cannot respond to the person making the page.

Loudspeaker Paging

Loudspeaker Paging is used when a loudspeaker paging system is connected to the system on a line/trunk jack programmed for Loudspeaker Paging. Pages over a loudspeaker paging system are heard everywhere in the building or only in a particular area, depending on whether or not the loudspeaker system is a multizone paging system.

Considerations and Constraints

A telephone without a speakerphone, loudspeaker, or speakerphone adjunct cannot be a member of a speakerphone paging group.

After using Loudspeaker Paging, you must remember to disconnect the paging call. Otherwise, the loudspeaker paging system may not be available for someone else.

When you try to page a speakerphone paging group that is receiving a voice announcement, you hear a busy signal.

Some group members may not hear the announcement (because they are making pages, for example), but the caller is not notified unless none of the group telephones can broadcast the page; in this case, the caller hears a busy signal.

If an analog multiline telephone has had Voice Announce disabled through programming and you lift the handset while listening to a speakerphone page, you are disconnected from the page.

If a multiline telephone has Voice Announce active and you lift the handset while listening to a page, the page continues and you can still make a call.

A maximum of three line/trunk jacks can be programmed for Loudspeaker Paging and used to connect a single-zone or multizone paging system. Each zone requires its own loudspeaker paging jack, and you cannot dial a single access code to reach more than one paging system at a time.

Using the speakerphone for making a Speakerphone or Loudspeaker Paging call can cause a feedback tone.

Loudspeaker paging jacks are LS or GS line ports programmed as paging ports. Up to three can be programmed. An extension jack cannot be programmed for loudspeaker paging.

Any loop-start or ground-start/loop-start line/trunk jack can be assigned as a loudspeaker paging jack. A line/trunk jack on an 800 DID, 100D, or 400EM (tie trunk) module cannot be programmed as a loudspeaker paging jack.

A loudspeaker paging jack cannot be assigned to a pool that contains lines/trunks used to make or receive outgoing calls.

When a line/trunk jack is assigned for Loudspeaker Paging, only the loudspeaker paging system can be connected.

If the loudspeaker paging system is multizone, you must dial the appropriate zone number specified by the paging system before making an announcement.

The system supports loudspeaker systems with talkback (bidirectional paging), which allows you to respond to pages.

In Release 6.0 and later systems (Hybrid/PBX mode only), loudspeaker and voice paging calls cannot be made to non-local dial plan extensions or paging groups.

Prior to Release 2.1, users at extensions programmed with Forced Account Code Entry need to enter an account code to use Loudspeaker Paging. In Release 2.1 and later systems, users at extensions programmed with Forced Account Code Entry do not need to enter an account code to use Loudspeaker Paging.

Telephone Differences

Direct-Line Consoles

The line/trunk jack programmed for Loudspeaker Paging can be assigned to a button on an analog or digital Direct-Line Console (DLC) for one-touch access. An operator with an MLX DLC also can access a loudspeaker paging system by dialing the line/trunk number (801–880) for the line/trunk jack on which the loudspeaker paging system is connected.

Queued Call Consoles

A QCC cannot make or receive voice-announced inside calls, which are speakerphone calls to an individual extension. A QCC cannot be a member of a speakerphone paging group and cannot receive group pages; however, it can make announcements to a paging group.

A QCC operator can use the Group Paging feature either by selecting a Call button and pressing the DSS button or by dialing the extension for the group.

A QCC operator can use a loudspeaker paging system only by selecting a Call button, selecting *Loudspeaker Paging* from the display, and then dialing the Loudspeaker Paging line number (801–880).

Cordless and Cordless/Wireless Telephones

MLC-5, MDC 9000, and MDW 9000 telephones cannot be members of paging groups or receive speakerphone pages.

Loudspeaker pages can be made from MLC-5 cordless telephones.

All Other Multiline Telephones

To receive pages, a multiline telephone must have Voice Announce on, which is the factory setting. An analog multiline telephone requires two consecutive jacks to the telephone: one for ringing calls and another for pages.

To direct Speakerphone Paging to an individual extension, select an SA Voice or ICOM Voice button, dial the extension number, and speak into the handset or speakerphone. To direct Speakerphone Paging to a group of extensions or to all extensions by using Page All, select any SA or ICOM button, press the programmed Group Page button or dial the extension for the speakerphone paging group or Page All group, and speak into the handset. Using a speakerphone for a group page can cause feedback.

A multiline telephone user can access the loudspeaker paging equipment. Make a Loudspeaker Paging announcement in the following ways:

- Select a line button programmed for the line/trunk jack on which the loudspeaker paging system is connected.
- Select an SA button and dial the pool dial-out code for the loudspeaker paging jack.
- Select an SA or ICOM button—either by pressing a Pickup button programmed specifically for the paging line or by pressing the Feature button and then dialing 9—followed by the paging line number (801–880).
- Select *Loudspeaker Page* from the display (MLX display telephones only) and dial the line number (801–880).

Once the loudspeaker paging system is accessed, dial the assigned code number for the paging zone (if required by the loudspeaker paging system) and speak into the handset.

Single-Line Telephones

Single-line telephones cannot receive pages, even if they have speakerphones. They cannot be included as members of a speakerphone paging group.

Single-line telephones cannot be used to make or receive voice-announced inside calls (Speakerphone Paging directed to individual extensions).

To direct Speakerphone Paging to a group of extensions or to all extensions by using Page All, lift the handset. Then, while listening to inside dial tone, dial the extension number of the paging or Page All group, and speak into the handset.

To use Loudspeaker Paging while listening to inside dial tone, lift the handset and dial #9 (Pickup), then dial the paging jack's line number and speak into the handset. The paging jack is normally not assigned to a single-line telephone.

Feature Interactions

Account Code Entry	Prior to Release 2.1, users at extensions programmed with Forced Account Code Entry need to enter an account code to use Loudspeaker Paging. In Release 2.1 and later systems, this restriction is removed.
Auto Dial	A speakerphone paging group extension number can be programmed onto an inside Auto Dial button.
Barge-In	Operators cannot use Barge-In to join speakerphone or loudspeaker paging calls.
Callback	A speakerphone paging (voice-announced inside) call that is queued by using Callback automatically becomes a ringing call. Callback cannot be used for calls to a speakerphone paging group. Systems with loudspeaker paging can be set up to allow calls to be queued for the loudspeaker paging system by placing the loudspeaker paging line in its own pool and having users access the paging system through the pool. When the pool is busy, calls to the loudspeaker paging system can be queued.
Call Waiting	Call Waiting cannot be used for calls to busy speakerphone paging groups.
Camp-On	Camp-On cannot be used for calls to busy speakerphone paging groups.
Conference	Group and loudspeaker paging calls cannot be added to a conference.
Digital Data Calls	Digital communications devices and videoconferencing systems can be assigned to paging groups. However, they should not be: they are not alerted if there is a call to a paging group, and they cannot make group pages.
Direct Station Selector	A DSS button for a line/trunk programmed as a loudspeaker paging line is used only to indicate whether the paging system is in use and cannot be used to gain access to the loudspeaker paging system. A DSS button can be used only to dial an extension for a paging group. When a DSS button for a paging group is pressed, transfer is not automatically initiated.
Display	When users with MLX display telephones use Group Paging, they see a message on the display, indicating the number of the paging group. If a loudspeaker paging jack is not programmed, <i>Loudspeaker Page</i> does not appear as a feature choice on MLX display telephones.

Do Not Disturb	Speakerphone paging calls cannot be made to an extension with the Do Not Disturb feature activated.
Forward and Follow Me	Calls cannot be forwarded to a paging group. The line/trunk number used to connect loudspeaker paging equipment cannot be used to forward calls to outside telephone numbers.
Headset Options	With a headset, you can hear group pages over the speakerphone.
Hold	A paging call can be put on hold by the caller. An inside voice-announced call can be put on hold by the person being called.
HotLine	A HotLine extension cannot access Loudspeaker Paging, but a HotLine extension can be programmed to dial a Group Paging number.
Inspect	If you get a voice-announced inside call or a group page while using the Inspect feature, the Inspect feature is canceled and you are returned to the Home screen.
Microphone Disable	Calls made to speakerphone paging groups can still be heard over telephones where microphones are disabled.
Multi-Function Module	An MFM should not be a member of a speakerphone paging group.
Night Service	A line/trunk jack programmed as a Loudspeaker Paging port cannot be assigned to a Night Service group.
Personal Lines	A line/trunk used for loudspeaker paging equipment cannot be assigned as a personal line.
Pickup	When the line number used for loudspeaker paging is not assigned to a button on a multiline telephone, you can access the loudspeaker paging system with Individual Pickup: dial the paging jack's line number (801-880) or program a Pickup button specifically for the paging line number.
Pools	In Hybrid/PBX mode, line/trunk jacks used for loudspeaker paging cannot be assigned to pools.
Primary Rate Interface and T1	If the extension for an incoming PRI call matches a group paging extension, the call is treated as an unassigned Direct Inward Dial call. Data lines cannot be used for paging.
Remote Access	Loudspeaker Paging cannot be accessed from outside the system through either DID lines or remote access.
Service Observing	In Release 6.1 and later systems, a Group Page call cannot be observed. A Loudspeaker Page call cannot be observed.
SMDR	Paging calls are not printed on the SMDR report.
System Access/ Intercom Buttons	Announcements using Speakerphone Paging can be made from a Shared SA button. Users cannot, however, join a page on a Shared SA button.
System Renumbering	Extensions for paging groups can be renumbered. The factory-set extensions are 793 through 799; Page All is 799.

Features
Paging

478

Transfer	Calls cannot be transferred either to paging groups or the loudspeaker paging extension.
UDP Features	In Release 6.0 and later systems (Hybrid/PBX mode only), loudspeaker and voice paging calls cannot be made to non-local dial plan extensions or paging groups.
Voice Announce	When you program your extension to turn off Voice Announce, you do not receive individual or group speakerphone pages. With an MLX telephone with Voice Announce to Idle Only on (Release 7.0 and later systems), you do not receive pages when you are active on a call.

Park

At a Glance

Users Affected	Telephone users, operators
Reports Affected	Extension Information, Operator Information, System Information (<i>SysSet-up</i>)
Modes	All
Telephones	All except single-line
Programming Codes	
Park at own extension	*86
Park Zone	*22 + park zone (DLC operators only)
MLX Display Label	
Park at own extension	Park
Park Zone	Park Zone [PrkZn]
System Programming	Assign return interval before unanswered parked call returns: ■ Options→CallParkRtn
Maximums	
No. of parked calls in park zones	8 (one parked call for each zone)
Factory Settings	
Park Zones	Ext. 881–888
Call Park Return Interval	180 sec (range 30–300 sec, in increments of 10 sec)
QCC Priority Level for returning parked calls	4 (range 1–7)

Description

Park puts a call on hold so that it can be picked up from any extension in the system. A user can park a call and then pick it up at another telephone, or can use paging to announce the call so that another person can pick it up. A parked call is picked up using the Pickup feature.

A user (but not a QCC operator) can park calls at his or her own extension by activating Park during the call, or by pressing the Transfer button, dialing his or her own extension number, and pressing the Transfer button again to complete the transfer. The green LED winks at the button where the call is parked and at all other associated SA and Shared SA buttons. At least two SA or ICOM buttons are required to use Park this way, and if you must park more than one call at a time, additional SA or ICOM buttons should be assigned to your telephone.

If a parked call is not picked up within the call park return interval (30–300 seconds; the factory setting is 180 seconds), the call returns to and rings at the extension that parked the call. Returning parked calls for a QCC operator can be programmed to return to a different operator.

The system also automatically reserves eight extensions (881–888) on which operators can park calls. Only operators can use these park-zone extensions.

Considerations and Constraints

Only system operators can use park zones. Operators must share the eight extensions (881–888) reserved for operator park zones.

To park a call at a park zone, an operator with a DSS presses the DSS button for the park zone while the caller is on the line. If an operator tries to park a call by pressing the Transfer button followed by the DSS button for the park zone, the call is put on hold for transfer and is not parked. This may result in unintentionally transferring a call to an outside number.

Telephone Differences

Direct-Line Consoles

DLC operators can park calls either by activating Park during the call or by pressing a DSS button programmed for an operator park zone. DLC operators also can park calls at their own extensions. For the park zones to be assigned to a DSS connected to an MLX DLC, the extension numbers must be in the range programmed for the Page buttons.

The eight park zone codes cannot be assigned to the DSS buttons on a MERLIN II System Display Console.

Queued Call Consoles

A QCC operator must have a DSS to park a call. To park a call, he or she either presses a DSS button for a park zone or presses the Start button and then a DSS button for an operator park zone. The call is automatically parked; the operator does not need to press the Release button.

QCC operators cannot park calls at their own extensions.

For park zones to be assigned to a DSS connected to a QCC position, the extension numbers must be in the range programmed for the Page buttons.

Calls parked by QCC operators can be programmed to return to the QCC queue, or they can be assigned to the QCC operator who parked the calls and/or to

another QCC operator. Returning parked calls are assigned a QCC priority level (the factory setting is 4) by using the Returning Call Type setting. A QCC operator can return a parked call to the message center position.

To pick up a parked call, a QCC operator selects `Pickup` from the display and dials the number for the extension or park zone where the call is parked.

Other Multiline Telephones

Multiline telephone users park calls at their own extension numbers by pressing programmed `Park` buttons. On an MLX display telephone, a user can press the `Feature` button and select `Park` from the display.

If a user pages another person to announce a parked call, he or she mentions the extension number where the call is parked.

A multiline telephone user also can park calls by pressing the `Transfer` button, dialing his or her own extension number (the user hears a busy tone), and then pressing the `Transfer` button again to complete the transfer. The call is automatically parked when the transfer is completed.

To pick up a parked call, the user presses a programmed `Pickup` button or the `Feature` button, dials 9, and then dials the extension number for the telephone or park zone where the call is parked. MLX telephone users also can press the `Feature` button and select the feature from the display.

Single-Line Telephones

To park a call, a single-line telephone user presses and releases either the `Recall` or `Flash` button or the switchhook and dials his or her own extension number. The user hears a busy tone, and the call is parked.



NOTE:

If a single-line telephone with a positive or timed disconnect is used—for example, the Lucent Technologies model 2500YMGL or 2500MMGK—pressing the switchhook disconnects the call. With this type of telephone, the `Recall` or `Flash` button, instead of the switchhook, must be used to park a call.

To pick up a parked call, the single-line user lifts the handset and (while listening to the inside dial tone) dials #9 and the extension number for the telephone where the call is parked.

Feature Interactions

- Authorization Code** Initiating Park after entering an authorization code deactivates the Authorization Code feature. An authorization code is not needed to pick up a parked call.
- Auto Dial** An operator can program park zones on inside Auto Dial buttons. An inside Auto Dial button also can be programmed with a user's (including an operator's) own extension number and can be used to park calls. When the system is programmed for one-touch Hold with manual completion, the user hears a busy signal and must complete the transfer either by hanging up or by pressing the Transfer button.
- Callback** Calls waiting in a callback queue cannot be parked.
- Conference** Conference calls cannot be parked. If a QCC operator tries to park a conference call by pressing the Start button and then pressing the DSS button for the park zone, the park is denied and the operator is reconnected to the conference call.
- Coverage** A returning parked call is not eligible for coverage. A call answered on a Primary Cover, Secondary Cover, or Group Cover button cannot be parked on that button. To park calls received on a Cover button at your extension, press the Transfer button, dial your own extension, and press the Transfer button again to complete parking the call.
- Digital Data Calls** Data calls cannot be parked.
- Direct Station Selector** For park zones to be assigned to a DSS connected to an MLX operator console, the extension numbers must be in the range programmed for the Page buttons.
- When an operator parks a call by using an associated DSS button and the call returns, the red LED associated with the park zone where the call is parked turns off and does not flash, as it does for a transfer return.
- To park a call at a park zone, an operator with a DSS presses the DSS button for the park zone while the caller is on the line. If an operator tries to park a call by pressing the Transfer button followed by the DSS button for the park zone, the call is put on hold for transfer and is not parked. This may result in an unintentional transfer to an outside number.
- Park zone numbers cannot be assigned to the DSS buttons on a MERLIN II System Display Console.
- Display** On a QCC, returning parked calls are identified by call type and the name or extension number of the operator who parked the call. The second line of the QCC display also shows the caller information. On 2-line displays, press the More button to see complete caller information.
- Forward and Follow Me** Returning parked calls are not forwarded.

Group Calling	A calling group member who parks a call is considered available to receive another call.
Headset Options	If a call is parked, another call can be automatically answered by using Headset Auto Answer.
Hold	<p>If a single-line telephone user with a call on hold hangs up, the call is disconnected. Park should be used instead of Hold.</p> <p>When a user or operator parks a call received on a personal line button and the call is picked up using Pickup at another extension and then put on hold, other users who share the personal line cannot press the line button and pick up the call.</p>
HotLine	Park cannot be used by HotLine extensions (Release 5.0 and later systems).
Line Request	A returning parked call cancels Line Request.
Multi-Function Module	A user at an MFM cannot park a call but can pick up a call parked by another user.
Music-On-Hold	If Music-On-Hold is programmed, a parked caller hears Music-On-Hold.
Pickup	A parked call can be picked up by using Individual Pickup.
Recall/Timed Flash	A single-line telephone user presses a Recall or Flash button to use Park.
Service Observing	In Release 6.1 and later systems, a call that is parked cannot be observed. Once an extension answers a parked call, the call can be observed.
SMDR	If an incoming call was parked but not picked up by the other extension, the extension of the user who activated Park is shown in the STN field of the SMDR record for the call. If an incoming call was parked and picked up by the destination extension, the destination extension is shown in the STN field of the SMDR report.
System Access/ Intercom Buttons	When a user parks a call made or received on an SA button, Shared SA buttons do not ring when the parked call returns.
System Renumbering	System operator park zones can be renumbered. (The factory-set zones are 881–888.)
Transfer	A user also can park calls by pressing the Transfer button, dialing his or her own extension, and pressing the Transfer button again. DLC operators can press Transfer and dial an operator park zone. When this method is used, complete the transfer by pressing the Transfer button or by hanging up. This method cannot be used by QCC operators.
UDP Features	For Release 6.0 or later systems (Hybrid/PBX mode only), park zones must be in the local system. Calls cannot be parked at remote system park zones.

Personal Lines

At a Glance

Users Affected	Telephone users, operators, data users
Reports Affected	Extension Information
Modes	All
Telephones	All except QCC
System Programming	Assign or remove personal lines: <ul style="list-style-type: none"> ■ Extensions→LinesTrunks Assign or remove principal user of a personal line: <ul style="list-style-type: none"> ■ LinesTrunks→More→PrncipalUsr
Maximums	64 extensions for each personal line 1 extension as principal user 3 simultaneous users for each personal line
Factory Settings	
Assigned Personal Lines	Analog DLCs: Lines 1–32 MLX DLCs: Lines 1–18 Multiline telephones: Lines 1–8 (Key mode)

Description

A personal line, also called a *direct facility termination* (DFT), is an outside line/trunk assigned to a button on one or more telephones or to another type of extension, such as a data communications device. A personal line can provide either the shared or exclusive use of a specific line/trunk. In Hybrid/PBX mode, a personal line allows users to receive outside calls without operator involvement.

When a personal line is assigned to more than one extension, a principal user of the personal line can be assigned through system programming. Assigning an extension as the principal user has the following effects:

- If Remote Call Forwarding is enabled for the extension, only the principal user can forward personal line calls to an outside telephone number.
- Unless the personal line is set to No Ring, calls received on the personal line follow the principal user's Individual or Group Coverage patterns.

To select a personal line to make or receive outside calls, The user presses the associated personal line button on a multiline telephone; a dial-out code is not needed. When the line is in use, the green LED is on at all multiline telephones that share the personal line.

Inside calls cannot be made or received on a personal line.

When two or more users answer the same call on a Shared SA or personal line button, the red and green LEDs next to the button go on, but only one person has a talk path with the caller. Privacy should be used to eliminate competition for the same call.

When an individual personal line is assigned to a line button on more than one telephone, up to three users of that personal line can participate in an in-progress call (including conference calls) on which Privacy has not been activated. Users select the personal line button with the call.

Personal lines can be assigned through system programming to single-line telephones or any other type of tip/ring device to allow a user to receive outside calls. Normally the Ringing/Idle Line Preference for single-line telephones or other tip/ring devices is activated, and Automatic Line Selection (ALS) is set to select an SA or ICOM button. With this arrangement in Key and Behind Switch modes, the single-line telephone user can select the personal line to make an outside call by dialing the Idle Line Access code (usually 9) while listening to inside dial tone.

In Hybrid/PBX mode, when either Ringing/Idle Line Preference is deactivated or ALS is set to select an SA button, a single-line telephone or tip/ring device user cannot select the personal line to make calls but can receive calls on the personal line.

For single-line telephones or other tip/ring devices in any mode of operation, ALS can be set to select the personal line. The user, however, cannot make inside calls or activate system features.

A multiline telephone user can program personal line buttons for Immediate Ring, Delay Ring, or No Ring. When a personal line button is programmed for No Ring, the user can still answer calls received on a personal line by pressing the personal line button with the flashing green LED. However, when a personal line is set to No Ring and Individual and/or Group Coverage is programmed for the user, calls received on the personal line are not sent to coverage.

If a personal line button is set for coverage of overflow for a Calling Group, the personal line button should be set to No Ring.

Considerations and Constraints

DID trunks should not be used as personal lines. If a DID trunk is assigned as a personal line, and a call received on the DID trunk is ringing at the extension programmed to receive the calls (the routing extension), the call can be answered by using the personal line button. This, however, is not recommended, because the purpose of DID trunks is to route calls to specific extensions without the need for personal line assignment or operator assistance.

If a line/trunk is not assigned as a personal line, grouped in a pool (Hybrid/PBX only), or assigned to ring into the Queued Call Console (QCC) queue, and a call is received on the line/trunk, the caller hears a ringback even if that line/trunk does not terminate anywhere in the system.

When an extension is programmed as the principal user (owner) of a personal line, only the principal user can forward calls to an outside number by using Remote Call Forwarding. When the owner has Individual or Group Coverage, calls received on the personal line follow the owner's coverage and not the coverage patterns of other extensions that share the personal line.

When no principal user is assigned for a personal line, calls received on the personal line cannot be forwarded to outside telephone numbers or to non-local extensions (Release 6.1 and later systems). Calls follow the Individual Coverage patterns of all senders who share the line and the Group Coverage pattern of the extension with the lowest logical identification number (lowest numbered jack on the module).

Two users can join a call in progress (including a conference call), for up to three users on the same personal line.

Outside lines/trunks used as personal lines cannot be assigned to pools and cannot be assigned as jacks for loudspeaker paging, Music-On-Hold, or maintenance alarms.

ARS cannot be used on personal lines.

In all modes, personal lines are not factory-assigned to single-line telephones or tip/ring devices connected to 016 (T/R), 012 (T/R), or 008 OPT modules, or to ports programmed for tip/ring operation on 016 ETR or 412 LS-ID-ETR modules.

In Release 2.1 and later systems, calls received on personal lines with Do Not Disturb on go immediately to coverage instead of waiting for the Coverage Delay Interval.

Mode Differences

Hybrid/PBX Mode

When Ringing/Idle Line Preference is turned on and ALS is set to select an SA button, a single-line telephone user cannot select the personal line to make calls. Outside calls, however, can be received on the personal line.

In Hybrid/PBX mode, the factory setting assigns personal lines to DLC positions rather than to other multiline telephones.

Key and Behind Switch Modes

When Ringing/Idle Line Preference is turned on and ALS is set for an ICOM button, a single-line user can select the personal line to make an outside call by dialing the Idle Line Access code (usually 9) while listening to inside dial tone.

In Key mode, the factory setting for personal lines assigns the first eight lines connected to the system as personal lines on all multiline telephones, including Multi-Function Modules (MFMs) connected to MLX telephones.

In Behind Switch mode, the factory setting assigns personal lines to DLC positions rather than to multiline telephones.

Telephone Differences

Direct-Line Consoles

The factory setting for analog DLCs assigns the first 32 lines connected to the system as personal lines in all modes of operation. For MLX DLCs, the first 18 lines connected to the system are automatically assigned as personal lines.

Queued Call Consoles

Personal lines cannot be assigned to a QCC or to a pool.

Other Multiline Telephones

A personal line is selected by pressing the associated personal line button. Dial-out codes are not required for making outside calls.

Single-Line Telephones

A single-line telephone user can receive calls on a personal line. To allow a single-line telephone user to select a personal line to make a call, Ringing/Idle Line Preference must be turned on and ALS must be set to select an SA or ICOM button. In Key and Behind Switch modes, the single-line telephone user with this arrangement can select the personal line to make an outside call by dialing the Idle Line Access code (usually 9) while listening to inside dial tone.

Feature Interactions

Account Code Entry When Forced Account Code Entry is assigned to an extension and the user tries to dial an outside call on a personal line button without entering the account code, the call does not go through.

Alarm A line/trunk jack used for a maintenance alarm cannot be assigned as a personal line.

Allowed/ Disallowed Lists	A user with an outward- or toll-restricted extension cannot dial a toll or outside number on a personal line button, unless the number is on an Allowed List assigned to the extension. Nor can the user dial a number on a Disallowed List.
Auto Dial	An outside Auto Dial button can be used on a personal line.
Callback	The Callback feature cannot be used to request a busy personal line.
Caller ID	Caller ID information appears on the display of shared personal lines. Outgoing call information is not displayed.
Calling Restrictions	A user with an outward- or toll-restricted extension cannot dial a toll or outside number on a personal line button unless the number is on an Allowed List assigned to the extension, nor can the user dial a number on a Disallowed List.
Call Waiting	A user does not hear a call-waiting tone for calls received on a personal line unless the business subscribes to call-waiting service from the local telephone company.
Coverage	<p>Assigning a sender as the principal user of a personal line specifies that the calls received on the personal line are sent to the principal user's individual and group receivers. A principal user with Remote Call Forwarding on can forward calls received on the personal line to an outside number. Calls received on personal line buttons programmed for No Ring or on senders' extensions other than the principal user's are not eligible for coverage.</p> <p>If no principal user is assigned and the personal line is shared by other senders, calls received on the personal line are sent to all available Individual Coverage receivers for all senders sharing the line and to the Group Coverage receivers programmed for the sender with the lowest logical ID.</p> <p>In Release 2.1 and later systems, a call answered on a personal line using a Cover button can be picked up by anyone with a button for that personal line. The picked-up call, however, cannot be transferred because it is still considered to be on hold at the other extension.</p> <p>Prior to Release 2.1, once a person answers a call received on a personal line on a Cover button and puts the call on hold, the sender and any other user who shares the personal line cannot pick up the call by pressing the personal line button. For proper handling, the receiver should transfer the call to the sender.</p> <p>In Release 2.1 and later systems, calls received on personal lines with Do Not Disturb on go immediately to coverage instead of waiting for the Coverage Delay Interval.</p>

CTI Link

When a call is received on a personal line at an unmonitored DLC, caller information is passed on to destination extension or extensions that support screen pop, when the DLC operator conferences or transfers the call.

If a calling group call is delivered to an overflow calling group extension where no SA buttons are available, it can instead arrive at a personal line button for that call. In this case, screen pop will not occur at the destination extension. For this reason, personal line button at overflow calling group extensions should be set to No Ring, so that overflow calls arrive at SA buttons only.

Digital Data Calls

Personal lines can be assigned to digital communications devices and videoconferencing systems; these, ideally, should not share personal lines except with extensions at the same workstations. If they do share personal lines, the system manager should ensure that enough idle lines are available, particularly when a video system is receiving 2B data calls. Otherwise, the video system may receive only 1B data while another extension is using a second personal line.

When a personal line is shared between a digital data device and a telephone, voice calls are directed only to the telephone and data calls are received only by the digital communications device.

Personal lines can be shared between an MLX telephone and a digital communications device connected to the MLX adjunct extension, provided that the communications device supports this capability.

Directories

A Personal Directory (MLX-20L only) or System Directory can be used to dial numbers on a personal line. An Extension Directory is used only for inside calls and cannot be used to dial calls on a personal line.

Forward and Follow Me

When an extension is programmed as the principal user of a personal line, calls received on the personal line can be forwarded to an outside number or to a non-local extension (Release 6.1 and later systems), if the extension can use Remote Call Forwarding, unless the outside line is a loop-start line with unreliable disconnect. (In Release 6.0 and later systems, reliable disconnect is not required for the Centrex Transfer via Remote Call Forwarding feature.)

Forward on Busy (Release 4.1 and later systems) does not apply to calls received on personal line buttons.

Group Calling

If a person uses a shared personal line button to join a call in the calling group queue, the call is removed from the queue. If a delay announcement is playing, it is disconnected from the call.

Group Calling
(continued)

To allow all calling group members' telephones to ring when an outside call is not answered within three rings, the lines/trunks programmed to ring into the queue also can be assigned as personal lines on group member telephones and programmed for Delay Ring. This does not work for inside calls, remote access calls, DID calls, or when a delay announcement device is assigned to the group.

In a Hybrid/PBX mode system where the Most Idle agent hunt type (Release 5.0 and later systems) is used, a calling group member may receive a calling group call at an SA button, then put that call on hold at the SA button. If the agent then picks up the call at a personal line button at his or her telephone, the system does not move the agent to the end of the most-idle queue (Release 5.0 and later systems).

Hold

If a call is received on a personal line and is transferred to another user who receives the call on an SA or ICOM button and puts the call on hold, users who share the line cannot select the personal line button and pick up the call. If the person who received the transfer and put the call on hold cannot return to the call, another user must use the Pickup feature to enter the line number and pick up the call.

In Release 2.1 and later systems, a call that has been put on hold at a Cover, SA, Shared SA, or Pool button can be picked up by a user who has a personal line button for the call. When the call is picked up, the green LED next to the personal line lights steadily; however, the call remains on hold at the Cover, SA, SSA or Pool button. The user who picks up on the personal line cannot transfer the call that has been picked up. In order to transfer a call on hold at a Cover, SA, SSA, or Pool button, use Pickup instead of picking up on a personal line button.

Multi-Function Module

If an MFM device is used to answer calls or provide supplementary ringing for its associated MLX telephone, any personal lines removed from the telephone should also be removed from the MFM. When the device connected to an MFM requires a personal line to make and/or receive calls (a modem or fax, for example), a personal line should be assigned.

Music-On-Hold

A line/trunk used for Music-On-Hold cannot be assigned as a personal line.

Night Service

If the voice mail calling group is assigned as a member of a Night Service group, incoming lines receive Automated Attendant treatment. When a call is answered by the Night Service group, ringing does not occur at a telephone with that personal line and the Night Service coverage is used instead of the principal user's coverage.

In Release 4.1 and later systems, a personal line can be assigned to a Night Service group. The personal line need not be assigned to the extension of the Night Service group operator in order to receive Night Service treatment.

Paging

A line/trunk used for loudspeaker paging equipment cannot be assigned as a personal line.

- Pickup** If a call received on a personal line is transferred to another user who receives the call on an SA or ICOM button and then puts the call on hold, another user who shares the personal line cannot select the shared personal line button to pick up the call. If the user who received the transfer and put the call on hold cannot return to the call, another user must use Line Pickup to pick up the call. For example, an operator can take a message and then disconnect the caller.
- Pools** A personal line cannot be assigned to a pool.
- Primary Rate Interface and T1** A personal line can be assigned to an extension to represent a PRI line with routing by dial plan. The green LED associated with the personal line lights steadily, and ringing on an SA button occurs; the LED does not flash to indicate that a line/trunk is ringing.
- A personal line can be assigned on a telephone for monitoring the status of a data line; however, users *must not* use the personal line to attempt to complete a call.
- Privacy** When an individual personal line is assigned to more than one extension, a user with the personal line cannot join an in-progress call on which Privacy has been activated.
- Recall/Timed Flash** When two users have joined an outside call on a shared personal line (loop-start only), Recall can be used by either inside party.
- Service Observing** In Release 6.1 and later systems, calls made or received on Personal Lines can be observed. A Service Observer cannot use a Personal Line to observe a call.
- Bridging takes priority over Service Observing; an observer is dropped before a bridge is denied. If a call on a Personal Line is being observed and a third internal extension is bridged onto the call, the Service Observer is dropped from the call.
- System Access/ Intercom Buttons** When a call on a personal line button is transferred to another user, the call rings on an SA or ICOM button. The LED next to the personal line flashes rapidly to indicate that the call is on hold for transfer. If the call is answered at an SA or ICOM button, the LED next to the personal line turns on steadily. If a user shares the personal line appearance and answers the call by using the personal line button, the call is removed from the SA or ICOM button.
- Tandem Switching** In Release 6.0 and later systems (Hybrid/PBX mode only), to avoid toll fraud, private-networked trunks should not be assigned to any extensions as personal lines.

Features
Personal Lines

492

Transfer	<p>If a call is received on a personal line and is transferred to another user who receives the call on an SA or ICOM button and then puts the call on hold, another user who shares the personal line cannot select the shared personal line button and pick up the call. If for some reason the person who received the transfer and put the call on hold cannot return to the call, another user must use Pickup to pick up the call. For example, an operator can take a message and then disconnect the caller.</p>
UDP Features	<p>To avoid toll fraud for Release 6.0 or later systems (Hybrid/PBX mode only), private network trunks must not be assigned to extensions as personal lines.</p> <p>In Release 6.1 and later systems, the principal user of a personal line can forward calls to a non-local extension.</p>

Features

Personalized Ringing

493

Personalized Ringing

See ["Ringing Options" on page 618.](#)

Pickup

At a Glance

Users Affected	Telephone users, operators
Reports Affected	Extension Information, Group Call Pickup
Modes	All
Telephones	All (except MLC-5, which cannot be assigned to Pickup groups)
Programming Codes	
Individual Pickup	
General use	*9
Specific extension	*9 + ext. no.
Specific line	*9 + line no.
Group Pickup	*88
Feature Codes	
Individual Pickup	
Specific extension	9 + ext. no.
Specific line	9 + line no.
Group Pickup	88
MLX Display Labels	
Individual Pickup	
General use	Pickup,General [Pkup,Genrl]
Specific extension	Pickup,Extension [Pkup,Ext]
Specific line	Pickup,Line [Pkup,Line]
Group Pickup	Pickup,Group [Pkup,Group]
System Programming	Assign or remove telephones from Pickup groups: ■ Extensions→Call PickUp
Maximums	30 Pickup groups 15 members for each group 1 Pickup group for each telephone

Description

Pickup allows users to answer calls that are ringing, parked, or on hold anywhere in the system. There are two types of Pickup: Individual and Group. Individual Pickup can be used in three ways: Extension, Line, and General. [Table 30](#) shows the calls that can be answered with each type of Pickup. Note that if more than one call is ringing or on hold, the first call received is the one picked up.

Table 30. Types of Pickup – Individual

Extension	Line	General	Group
Inside ringing	Outside ringing	Inside ringing	Inside ringing
Inside held	Outside held	Inside held	Outside ringing
Parked		Outside ringing	
Outside ringing		Outside held	
Outside held			

Individual Pickup

Individual Pickup can be used in the following ways:

- **Extension Pickup.** From the display, select `Pickup` and then dial the extension number of the call to be picked up. Alternatively, set a programmed Individual Extension Pickup button to pick up calls on one specific extension. If that extension has more than one call, the first call sent to the extension is picked up. To pick up a call parked by an operator, select `Pickup` from the display or press the programmed Individual Extension Pickup button; then dial the park zone.
- **Line Pickup.** From the display, select `Pickup`, then dial the line number (801–880) to select a specific outside line from which to pick up a ringing or held call. Alternatively, a programmed Individual Line Pickup button can be set to pick up calls on one specific line. Line Pickup also can be used to make announcements through the loudspeaker paging system.
- **General Pickup.** Multiline telephone users can program a general-purpose Pickup button to pick up calls on either extensions or lines. When a general Pickup button is used, enter the line or extension number for the call to be picked up every time the button is used.

Group Pickup

Group Pickup is used to answer a ringing call for any member of the group, either by dialing the Group Pickup code or pressing a programmed Group Pickup button. It is not necessary to know the extension number or line number of the ringing call. The system automatically connects to an inside or outside call that is ringing at a telephone assigned to the group.

A telephone cannot be assigned to more than one Pickup group.

Considerations and Constraints

When Group Pickup is used to answer a call, the user cannot determine whose call is being answered. An MLX display telephone user receives call information and can determine whose call is answered only after the call is picked up.

Individual Pickup, not Group Pickup, is used to pick up calls parked in a park zone by an operator.

Telephone Differences

Direct-Line Consoles

A DLC can be part of a Pickup group. This allows other group members to provide backup coverage for the DLC. A DLC operator can use Pickup to answer calls on lines/trunks that are not assigned to buttons on the console.

Queued Call Consoles

Individual Pickup

To pick up a call by using a Queued Call Console (QCC), select the feature from the Home screen, or press the Feature button and select the feature from the display. Then press the DSS button or dial the extension for the telephone or park zone.

To answer calls on specific lines, select the feature from the Home screen or press the Feature button and select the feature from the display; then dial the line number (801–880) with the call.

Group Pickup

To pick up a call ringing on any other group member's telephone, select *Pickup Grp* from the Home screen, or press the Feature button and select the feature from the display.

Other Multiline Telephones

Individual Pickup

To pick up a call on all other multiline telephones, press a programmed general-purpose Pickup button, or press the Feature button and dial 9. On MLX telephones, you also can press the Feature button and select the feature from the display, then dial the number for the extension or park zone.

To answer calls on specific lines, press a programmed general-purpose Pickup button, or press the Feature button and dial 9; then dial the number of the line with the call.

If a Pickup button is programmed for a specific telephone or outside line, press that Pickup button to pick up a call.

Group Pickup

To pick up a call ringing on any other group member's telephone, press a programmed Group Pickup button, or press the Feature button and dial 88. MLX telephone users also can press the Feature button and select the feature from the display.

MLC-5 cordless telephones cannot be assigned to Pickup groups.

Single-Line Telephones

Individual Pickup

To pick up a parked call, lift the handset and (while listening to the inside dial tone) dial #9 and the extension number for the telephone or park zone.

Group Pickup

To pick up a call ringing at any other group member's telephone, lift the handset and (while listening to the inside dial tone) dial #88.



NOTE:

When on a single-line telephone, if you put a call on hold to pick up another call by using Individual or Group Pickup, you cannot put the picked-up call on hold to return to the first call. If you press the Recall or Flash button (or, on a telephone that does not have timed or positive disconnect, if you press and release the switchhook), the picked-up call is dropped and you are reconnected to the original held call. If you hang up, the picked-up call is disconnected and the first call is considered on hold for transfer, is returned to you after the transfer return interval.

Feature Interactions

- | | |
|---------------------|---|
| Callback | A callback request cannot be picked up at another telephone. |
| Call Waiting | Pickup cannot be used to answer a waiting call at another extension. |
| Conference | A conference call cannot be picked up at another extension. A conference originator can, however, pick up a call and add it to the conference call. |

- Coverage** An Individual or Group Coverage sender or receiver can be a member of a Pickup group. This allows Pickup to be used to answer a ringing Individual or Group Coverage call. If a sender who is a member of a Pickup group uses Coverage On/Off to prevent calls from being sent to Individual or Group Coverage receivers, his or her calls can be picked up by using Individual Pickup; however, calls cannot be picked up by using Group Pickup. When a coverage call is answered by using Pickup, the call appearance is removed from all other telephones in the coverage arrangement.
- Digital Data Calls** A digital communications device can pick up a data call. Pickup is not recommended at video system extensions.
- Direct Station Selector** The DSS buttons associated with a line/trunk number (801–880) cannot be used to answer calls on specific lines by using Individual Pickup. These DSS buttons are used strictly to show the busy or not-busy status of each line/trunk.
- Display** When a user with an MLX or ETR display telephone selects Pickup, the *Pickup Line/Ext :* prompt appears on the display. (The prompt is not displayed if a button is programmed to pick up a specific line or extension.) After the user enters the line or extension number to pick up the call, a confirmation message appears (for example, *Pickup : OUTSIDE* or *Pickup : JOE*) only on the MLX telephone.
- Forward and Follow Me** Pickup cannot be used to answer calls being forwarded to an outside telephone number.
- Group Calling** A calling group member can be a member of a Pickup group. Calling group members can use Pickup to answer a call (either a calling group or individual group member extension) that is ringing at another group member's telephone. Line Pickup can be used to pick up a call that is in the calling group queue. If an agent has a call on hold and the agent or someone else picks up the call, the system moves the agent to the end of the most-idle agent queue (Release 5.0 and later systems).
- HotLine** Pickup cannot be used at a HotLine extension (Release 5.0 and later systems).
- Night Service** A call ringing at a Night Service group extension can be answered from another extension by using Pickup.
- Paging** When the line number used for loudspeaker paging is not assigned to a button on a multiline telephone, you can access the loudspeaker paging system either by using Individual Pickup and dialing the loudspeaker paging line number (801–880) or by using a Pickup button specifically programmed for the paging line number.
- Park** A parked call can be picked up by using Individual Pickup.

Personal Lines	If a call received on a personal line is transferred to another user who receives the call on an SA or ICOM button and then puts the call on hold, another user who shares the personal line cannot select the shared personal line button to pick up the call. If the user who received the transfer and put the call on hold cannot return to the call, another user must use Line Pickup to pick up the call. For example, an operator can take a message and then disconnect the caller.
Service Observing	In Release 6.1 and later systems, when an extension answers a call by using Pickup, the call can be observed.
SMDR	The extension of a user who picks up a call by using Pickup appears on the SMDR report.
System Access/ Intercom Buttons	<p>If Pickup is used to answer a call ringing at an SA or Shared SA button, the call is removed from the ringing telephone and is moved to the SA or SSA button used to pick up the call. The green LED turns on next to the SA button used to answer the call and next to all SSA buttons programmed for that specific button.</p> <p>An <i>inside</i> call ringing at an SA or SSA button can be picked up at another telephone. All associated SA and SSA buttons go idle.</p>
Transfer	A transferred call can be answered by using Pickup.
UDP Features	In Release 6.0 and later systems (Hybrid/PBX mode only), a call at a non-local extension cannot be picked up in the local system.

Pools

At a Glance

Users Affected	Telephone users, operators, data users
Reports Affected	Dial Plan Information
Modes	Hybrid/PBX only
Telephones	All
System Programming	Assign individual lines/trunks to pools: <ul style="list-style-type: none"> ■ LinesTrunks→Pools Assign Pool buttons to telephones: <ul style="list-style-type: none"> ■ Extensions→LinesTrunks Restrict telephone from using pool dial-out code: <ul style="list-style-type: none"> ■ Extensions→Dial OutCd
Maximums	
Pools for each system	11
Lines/trunks for each pool	Unlimited
Buttons assigned for each pool	64
Factory Settings	
Main Pool	70
Ground-Start Trunk Pool	890
Dial-In Tie Trunk	891
Automatic-In Tie Trunk	892
Pool Dial-Out Code Restriction	No access to any pool

Description

Hybrid/PBX mode allows outside lines/trunks to be grouped together in pools. Users select lines/trunks by using SA buttons, instead of having separate buttons for each line/trunk in the system. To access pools using SA buttons, people dial pool dial-out codes. Pools also can be assigned to buttons on one or more telephones to allow a user to select the pool without dialing the pool dial-out code or ARS access code. In Release 3.1 and later systems, the factory setting does not allow any extensions to use pool dial-out codes. To allow a user to access a pool by entering a dial-out code, the system manager must remove the restriction for the dial-out code and the extension.

When the system is set up and the Hybrid/PBX mode of operation is selected, the system automatically groups lines/trunks into the following pools:

- All loop-start lines (basic and special-purpose) are assigned to the main pool. The factory-set extension number for the main pool is 70.
- All ground-start trunks are assigned to the pool with the factory-set extension number 890.



NOTE:

On initialization of a Release 1.0 system, all loop-start and ground-start line/trunk programming reverts to loop-start. The ground-start pool never has trunks assigned to it automatically but must be programmed after the ground-start jacks are designated. In Release 1.1 and later systems, ground-start trunks are assigned to the ground-start pool on initialization, except in a system modified for permanent Key mode operation.

- All dial-in tie trunks are assigned to the pool with the factory-set extension number 891.
- All automatic-in tie trunks are assigned to the pool with the factory-set extension number 892.



NOTE:

The factory setting for the type of line/trunk connected to a 400 LS, 800 GS/LS, 408 GS/LS, 408 GS/LS-MLX, 408 GS/IS-ID-MLX, 800 GS/LS-ID, or 412 LS-ID-ETR module is loop-start. The system does not automatically make pool assignments for loop-start, ground-start, or tie trunks that are emulated by using a T1 facility. Each of these types must be grouped into a pool through system programming.

The system can have a maximum of 11 pools. Each pool can be assigned to a button on a maximum of 64 extensions. The number of lines/trunks in each pool is limited only by the number of lines/trunks connected to the system. A line/trunk, however, can be assigned to only one pool.

In Release 6.0 and later systems (Hybrid/PBX mode only), consider the following points when planning pools:

- All private networked trunks must be assigned to pools; a different pool should be used for each type of trunk (T1-emulated tie trunks, PRI trunks, and analog tie trunks).

- Users must not be given dial access or Pool button access to pooled private trunks. To use these pools, users dial non-local dial plan extensions just as they would local extensions. They also use these pools when they dial ARS for outside calls, and the ARS tables route the calls to other networked switches (see [“Automatic Route Selection” on page 77](#) and [“Tandem Switching” on page 699](#) for details).
- To allow local users to dial extensions on a remote networked system, UDP routing is used. Pools containing tandem PRI trunks should be assigned to Route 1. For details, see [“Uniform Dial Plan Features” on page 741](#).
- If a directly networked system has no trunks connected to the public switched telephone network, the pool and ARS assignments listed below are required in order to make equal access (10xxx, 101xxxx, also called *Interexchange or IXC*) calls.
 - The local system must have its networked trunks assigned to the main pool.
 - The local ARS access code is automatically prepended to the dialed number.
 - The local ARS access code must match that of a remote system that is networked to the local system.

**CAUTION:**

Because of the above requirement, it is a good idea for all systems in a private network to use the same ARS access code. If a networked system without PSTN trunks is in the same location as another networked system over which Special Numbers calls can go out to the PSTN and reach correct services, then the arrangement described above is practical. In most cases, however, each system in a network should have at least one loop-start line, which is assigned to the main pool and available in the event of a power failure. This allows Special Number calls (911 calls, for example) to reach the correct local services. It also means that IXC calls are routed to the main pool analog line or lines. If many IXC calls are made, then the number of lines assigned to the main pool must be increased.

- If a networked system has no trunks connected to the public switched telephone network, the following pool and ARS assignments are required in order to make Dial 0 or N11 calls:
 - The local system must have its networked trunks assigned to the main pool.
 - The local ARS programming must prepend the ARS access code of the remote switch that is directly connected to the local private network trunks.

- If remote users are going to use networked lines connected to your local system, the Remote Access feature is used to set them up. See [“Remote Access” on page 602](#) and [“Tandem Switching” on page 699](#).

Considerations and Constraints

The maximum number of Pool buttons that can be assigned to multiline telephones, excluding QCCs, is limited only by the maximum number of pools allowed (11) and the number of buttons on the telephone. The number of lines/trunks in each pool is limited only by the number of lines/trunks connected to the system. A line/trunk can be assigned to only one pool.

Each pool should contain the same type of lines/trunks (for example, basic, WATS, data-only, or foreign exchange) because users cannot control the specific trunks selected by the system. Ground-start and loop-start lines/trunks of the same type (for example, WATS) can be mixed in the same pool. DID trunks should not be put into pools; lines/trunks used for Music-On-Hold or maintenance alarms cannot be grouped into pools. Also, dial-in tie trunks should not be placed in a pool that is assigned to a button on the telephone.

Lines/trunks assigned to pools cannot be assigned as personal lines (on buttons) on any extension except a DLC. Calls that come in on lines/trunks assigned to pools, however, can be programmed to be received by one or more QCC operators.

When all lines/trunks in a pool are in use, the green LEDs turn on next to the Pool buttons assigned to multiline telephones and next to any DSS buttons associated with the pool dial-out code.

Individual extensions can be restricted to deny dial access to particular pools. See [“Calling Restrictions”](#) under [“Feature Interactions” on page 504](#).

Users with Pool buttons on their telephones can use the pool even if the pool dial-out restriction is assigned to the extension.

In Release 6.0 and later systems, all private network trunks must be assigned to pools.

In Release 6.0 and later systems, users should not be given dial-access or Pool button access to private networked trunks.

One pool can be assigned to buttons on a maximum of 64 extensions.

In Release 3.1 and later systems, if an extension is changed from a Direct-Line Console to a Queued Call Console, pool dial-out codes are disallowed on the QCC. You must use system programming if you want to allow access to dial-out codes on the QCC.

Mode Differences

Although pools are available only in Hybrid/PBX mode, users in Behind Switch mode can access the pools on the host system through their prime lines.

Telephone Differences

Direct-Line Consoles

A Pool button cannot be assigned to a DLC. A DLC operator accesses pools by dialing the pool dial-out code from an SA button or, on an MLX DLC with a DSS, by pressing the DSS button associated with the pool dial-out code. Trunks in pools cannot be assigned as personal lines (assigned to line buttons) on any telephone except a DLC. In Release 3.1 and later systems, the system manager, through system programming, must allow the DLC extension to access those pool dial-out codes that it needs.

In Release 6.0 and later systems, a DLC operator accesses pools of private trunks in the same way that other users do: by dialing a number in the non-local dial plan or via an ARS call that the system directs to a networked switch through private trunks.

Queued Call Consoles

A Pool Status button is assigned as a fixed-feature button on a QCC and provides an operator with the status of all the pools (maximum of 11) including those for private networked trunks (Release 6.0 and later systems only). The operator presses the Inspct button followed by the Pool Status button, and the busy or available status of pools appears on the display.

Pool buttons cannot be assigned to a QCC, but a QCC operator can use pools to make outgoing calls by selecting a Call button and dialing the ARS or pool dial-out code. In Release 3.1 and later systems, the system manager, through system programming, must allow the QCC extension to access those pool dial-out codes that it needs. A QCC operator can be assigned to receive calls on lines/trunks assigned to pools.

Feature Interactions

Account Code Entry When Forced Account Code Entry is assigned to an extension and the user tries to dial an outside call on a Pool button without entering the account code, the call does not go through.

Alarm A line/trunk jack used for a maintenance alarm cannot be assigned to a pool.

Auto Dial	Pool dial-out codes cannot be programmed on inside Auto Dial buttons. A pool dial-out code can be programmed on an outside Auto Dial button when a telephone number is also included. Depending on the local telephone company, however, Pause characters may be required before the telephone number. Pause characters are entered by pressing the Hold button.
Automatic Maintenance Busy	To provide optimal performance, Automatic Maintenance Busy should be enabled when a Hybrid/PBX system includes pools.
Automatic Route Selection	ARS ensures appropriate and cost-effective use of pools. ARS and the dial-access-to-pools restriction function independently of each other. If ARS restrictions are programmed to allow access to a pool, the user may seize a pool that the extension is not allowed to use under existing pool dial-access restrictions.
Callback	In Hybrid/PBX mode, Callback can be used to complete calls to outside numbers only when all lines/trunks in the pool are busy.
Caller ID	If the LS-ID Delay option is programmed on a two-way line, the system does not seize a line from a pool for an outgoing call when that line is receiving an incoming call.
Calling Restrictions	Specific pools can be restricted from use for outgoing calls by assigning a pool dial-out code restriction to extensions. In Release 3.1 and later systems, the factory setting is for all pool dial-out codes to be restricted for all users.
Coverage	Calls received on a sender's Pool button programmed for Immediate Ring or Delay Ring are eligible for Individual or Group Coverage.
CTI Link	When an MLX extension is programmed as a CTI link, dial access to pools is removed from the extension.
Digital Data Calls	If a videoconferencing system is programmed to have a single Pool button, two calls to that pool result in a 1B data call. If two separate pools are assigned to a videoconferencing system extension, however, then a 2B data call can be established. If the communications system includes two or more 2B data devices that share the same two pools, incoming 2B data calls can be answered by the wrong device.
Directories	When a pool dial-out code is included in the telephone number for a Personal or System Directory listing, Pause characters may be required following the pool dial-out code, depending on the local telephone company. Pause characters are entered by pressing the Hold button.
Display	When a display telephone user selects a Pool button and lifts the handset, the display shows the label (if programmed) for the lines in the selected pool.
Forward and Follow Me	A pool can be used to select the facility for forwarding calls to an outside telephone number. The pool dial-out code is entered before the telephone number.

Group Calling	Lines/trunks assigned to pools can be assigned to ring into a calling group. An incoming call on a line/trunk assigned to the pool rings on an SA button, even if the calling group member has a Pool button assigned to his or her telephone.
HotLine	A HotLine extension (Release 5.0 and later systems) can use a pool, as long as dial-access-to-pools is enabled for the extension and the Pool access code is programmed with the outside number as the first Personal Speed Dial number for the extension.
Line Request	Line Request cannot be used on a Pool button.
Music-On-Hold	Line/trunk jacks used for Music-On-Hold cannot be assigned to pools.
Paging	Line/trunk jacks for loudspeaker paging cannot be assigned to pools.
Personal Lines	A personal line cannot be assigned to a pool.
Primary Rate Interface and T1	Data lines (especially T1 data) should not be put in the same pool as voice lines. System alarms eventually result if voice extensions try to access data lines.
Recall/Timed Flash	If a user presses the Recall button during or after dialing, a timed flash is sent to the host switch, the accessed line is kept, the user hears dial tone, and calling restrictions are reapplied.
Service Observing	<p>In Release 6.1 and later systems, if an extension uses Dial Access to make a call, the call can be observed. A call placed or answered on a Pool button can be observed.</p> <p>A Service Observer cannot activate Service Observing while off-hook on a Pool button.</p>
Speed Dial	A pool dial-out code can be included with the telephone number associated with a Personal Speed Dial or System Speed Dial code. Depending on the local telephone company, however, Pause characters may be required immediately following the pool dial-out code. Pause characters are entered by pressing the Hold button.
SMDR	When outgoing calls are made by using a pool, the line/trunk selected by the system is reported on the SMDR report.
System Renumbering	Pool dial-out codes (the factory-set codes are 70 and 890–899) can be renumbered. Pool dial-out codes can be up to four digits long.
UDP Features	<p>All private trunks must be assigned to pools of trunks that are of the same type (PRI, analog tie, T1-emulated tie voice, or T1-emulated tie data). For security reasons, dial access and Pool button access to these pools should not be permitted.</p> <p>Pool Status buttons show the busy or not-busy status of private trunk pools as well as outside trunk pools.</p> <p>When PRI tandem trunks are available, their pools should be assigned as Route 1 for the purpose of UDP routing.</p>

Power-Failure Transfer

At a Glance

Modes	All
Telephones	Single-line telephones
Hardware	If ground-start trunks are used in Hybrid/PBX mode, KS23566, L1 ground-start buttons are required on power-failure telephones.

Description

During a commercial power failure, Power-Failure Transfer (PFT) provides incoming and outgoing service through power-failure telephones. When a power failure occurs, all calls are dropped and the power-failure telephone automatically goes on. It can make and receive calls on the line/trunk connected to the first (lowest) line/trunk jack on the module where the PFT telephone is connected.

A power-failure telephone is a single-line telephone connected to a PFT jack on a 400 (LS), 400 LS/TTR, 800 (LS), 800 GS/LS, 800 GS/LS-ID, 408 (LS-ATL), 408 GS/LS, or 408 GS/LS-MLX module. Each module has one PFT jack for each series of four line/trunk jacks; for example, the 800 (LS) and 800 GS/LS modules each have two PFT jacks.

Unlike other line/trunk modules, the 412 LS-ID-ETR module (Release 7.0 and later systems) does not have a dedicated jack for a power-failure telephone. Instead, in the event of a power failure, the top extension port automatically becomes a tip/ring port and receives dial tone from the first loop-start line port. You then can plug in a single-line telephone to make calls outside the system. You cannot use an ETR or MLS telephone.

Considerations and Constraints

A power-failure telephone cannot be used to make or receive calls and does not function when the system is operating normally.

System features and restrictions do not work when PFT occurs. Power-failure telephones are not working extensions but only dedicated power-failure devices.

Features

Power-Failure Transfer

508

Telephone Differences

Multiline Telephones

Multiline telephones cannot be used as power-failure telephones.

Single-Line Telephones

Touch-tone single-line telephones must be connected to PFT line/trunk jacks for touch-tone lines; rotary single-line telephones must be connected to PFT line/trunk jacks for rotary-dial lines.

Feature Interactions

SMDR No SMDR records are generated during a power failure.

Primary Rate Interface (PRI) and T1

At a Glance

Users Affected	Telephone users, operators, data users
Reports Affected	DS1 Information, PRI Information, SMDR
Modes	Key, Hybrid/PBX
Telephones	All (display support on MLX, ETR, and MLS telephones)
System Programming Systemwide	Specify modules that provide primary, secondary, and tertiary clock synchronization and source of clock synchronization; also activate/deactivate clock:
100D Module	<ul style="list-style-type: none"> ■ LinesTrunks→More→ClockSync Specify type of facility connected to 100D module: <ul style="list-style-type: none"> ■ LinesTrunks→LS/GS/DS1→Type Specify framing format for 100D module: <ul style="list-style-type: none"> ■ LinesTrunks→LS/GS/DS1→FrameFormat Specify line coding for 100D module: <ul style="list-style-type: none"> ■ LinesTrunks→LS/GS/DS1→Suppression Specify line compensation between 100D module and channel service unit (CSU) or far end: <ul style="list-style-type: none"> ■ LinesTrunks→LS/GS/DS1→Line Comp Specify type of CSU equipment provided by central office: <ul style="list-style-type: none"> ■ LinesTrunks→LS/GS/DS1→Channel Unit
PRI	Specify the type of switch (Release 4.2 and later systems): <ul style="list-style-type: none"> ■ LinesTrunks→PRI→SwitchType Assign telephone numbers to PRI lines: <ul style="list-style-type: none"> ■ LinesTrunks→PRI→Telephone Number Assign B-channels to group: <ul style="list-style-type: none"> ■ LinesTrunks→PRI→B-ChannlGrp→B-channels Assign PRI lines to B-channel groups: <ul style="list-style-type: none"> ■ LinesTrunks→PRI→B-ChannlGrp→Lines Specify type of network service for each B-channel group: <ul style="list-style-type: none"> ■ LinesTrunks→PRI→B-ChannlGrp→NetworkServ Specify whether telephone number to send to network for outgoing calls should be copied from line telephone number: <ul style="list-style-type: none"> ■ LinesTrunks→PRI→B-ChannlGrp→CopyNumber Specify telephone number to send to network for outgoing calls on PRI lines: <ul style="list-style-type: none"> ■ LinesTrunks→PRI→NumberToSend

Assign test line telephone number for each 100D module:

- LinesTrunks→PRI→Test TelNum

Set timer and counter thresholds for each 100D module:

- LinesTrunks→PRI→Protocol→Timers

Assign link layer address or Terminal Equipment Identifier (TEI) of equipment connected to each D-channel:

- LinesTrunks→PRI→Protocol→TEI

To select T1 emulation:

- LinesTrunks→LS/GS/DS1→Enter→Type→T1→Enter→Select type of emulation

To select T1 Switched 56 Data and program Channel Signaling:

- LinesTrunks→LS/GS/DS1→Enter→Type→T1→Enter→More→S56 Data→Enter→AssignChan-Signling→Enter→Select Direction, Intype, Outtype, AnsSupv, Disconnect, Inmode, or Outmode

To select T1 All Switched 56 Data and program Channel Signaling:

- LinesTrunks→LS/GS/DS1→Enter→Type→T1→Enter→More→All S56 Data→Signling→Enter→Select Direction, Intype, Outtype, AnsSupv, Disconnect, Inmode, or Outmode

To select T1 Switched 56 Data and program Incoming Routing Table:

- LinesTrunks→LS/GS/DS1→Enter→Type→T1→Enter→More→S56 Data→Enter→Incom Routing Table→Select Expected Digits, Add Digits, or Delete Digits→Enter

To select T1 All Switched 56 Data and program Incoming Routing Table:

- LinesTrunks→LS/GS/DS1→Enter→Type→T1→Enter→More→ALL S56 Data→Incom Routing Table→Select Expected Digits, Add Digits, or Delete Digits→Enter

Features

Primary Rate Interface (PRI) and T1

511

Maximums

General

100D modules 3

PRI-specific

B-channels 69

Lines (total) 72

Digits for each number 12

assigned to a PRI line

ISDN lines for each

B-channel group 24

B-channels for each

B-channel group 23

Digits for each telephone 12

number sent to network

for outgoing calls

Digits for test trunk 12

telephone number

PRI Dial-Plan Routing

Table (Hybrid/PBX)

Number of entries 16 (0–15)

Digits for each pattern 8

Digits to delete 14 (range 0–14, 0 = wildcard)

Digits to add 4

Network Selection Table

Number of entries 4 (0–3)

Digits for each pattern 8 (* = wild card; at least one * required; all *s must be at end and contiguous.)

Special Services

Selection Table

Number of entries 8 (0–7)

Digits for each pattern 4

Digits to delete 4 (range 0–4)

Call-by-Call Services

Table

Number of entries 10 (0–9)

Number of patterns for 10

each entry

Digits for each pattern 8

Digits to delete 8 (range 0–8)

T1-specific

T1 Dial-Plan Routing

Table

Number of entries 24 (1–24)

Expected Digits 3 (range 1–3)

Digits to delete 4 (range 0–4)

Digits to add 4 (range 0–4)

Features

Primary Rate Interface (PRI) and T1

512

Factory Settings

Systemwide

Primary Clock First port that is in service on an 800 NI-BRI module or first 100D module in service in control unit

Clock Synchronization Loop (not definable by system manager)

Source

Clock Active

100D Module

Type of Facility T1

Framing Format D4 compatible

Line Coding AMI-ZCS

Signaling Robbed-Bit Signaling (RBS)

100D Module

continued

Line Compensation 1 (range 1–5)
 1 = 0.6 dB loss
 2 = 1.2 dB loss
 3 = 1.8 dB loss
 4 = 2.4 dB loss
 5 = 3.0 dB loss

Type of CSU equipment Foreign Exchange

PRI

Telephone number assigned to PRI line 0 digits

B-channels assigned to group None

PRI lines assigned to B-channel groups None

Type of network service for each B-channel group None

Copy telephone number to send from telephone number assigned Do Not Copy

Telephone number to send to network for outgoing PRI calls 0 digits

Test trunk telephone number for each 100D module None

Call-by-Call Services

Table

Patterns Blank

Call type Both (Voice and Data)

Service Blank

Digits to delete 0

Features

Primary Rate Interface (PRI) and T1

513

Factory Settings

Timer/counter thresholds
 for each 100D module

T200 Timer	1 second (range 1,000–3,000 ms)
T203 Timer	30 seconds (range 1–60)
N200 Counter	3 transmissions (range 1–5)
N201 Counter	260 octets (range 16–260)
K Counter	7 frames (range 1–15)
T303 Timer	4 seconds (range 4–12)
T305 Timer	4 seconds (range 4–30)
T308 Timer	4 seconds (range 4–12)
T309 Timer	90 seconds (range 30–120)
T310 Timer	60 seconds (range 2–120)
T313 Timer	4 seconds (range 4–60)
T316 Timer	120 seconds (range 30–120)

Link layer address or TEI
 assigned

0 (range 0–63)

PRI Dial-Plan Routing

Table

Service value	
Digits for each pattern	Empty
Digits in Called Party	Blank
Number	0
Digits to add	

T1 Dial-Plan Routing

Blank

Table

Expected Digits	Blank
Digits to delete	0
Digits to add	Blank

Tandem PRI Trunks¹

B-channels assigned to group	All
Type of network service for the B-channel group	ETN (Electronic Tandem Network)
Copy telephone number to send from telephone number assigned	Copy

1 Release 6.0 and later systems only: When the switch type is set to LEGEND-Ntwk or LEGEND-PBX, these settings are made automatically and cannot be changed unless the switch type is changed. You can add or remove B-channels from the assigned B-channel group.

Description

The MERLIN LEGEND Communications System supports two types of service for Digital Signal Level 1 (DS1) facilities: T1 and PRI.

T1 service transmits and receives voice and analog data as well as digital data services in Release 4.0 and later releases.

The Integrated Services Digital Network (ISDN) PRI is a standard access arrangement that can be used to connect the system to a network providing voice and digital data services.

The MERLIN LEGEND Communications System supports connection to the following central office switches for PRI services:

- Releases 1.0 and 1.1 support Lucent Technologies 4ESS™ Generic 16.
- Release 2.0 supports these additional switches:
 - Lucent Technologies 5ESS Generic 6
 - Lucent Technologies 5ESS serving the FTS2000 (government only) network.
- Release 4.2 and later systems also support these switches:
 - NORTEL DMS-100 Generic BCS 36 for local exchange carrier services
 - NORTEL DMS-250 Generic MCI 07 serving the MCI network
 - Digital Switch Corporation DEX600E Generic 500-39.30 serving the MCI network

To provide T1 Switched 56 services in Release 4.0 and later systems, the system supports the following central office switches:

- Lucent Technologies 4ESS Generic 18/19/20
- Lucent Technologies 5ESS Generic 9.1
- Northern Telecom DMS-100 Generic BCS 34

You also can link a MERLIN LEGEND Communications System Release 4.0 or later with a Lucent Technologies DEFINITY ECS or DEFINITY ProLogix Solutions systems for data tie-trunk connections.

In Release 6.0 and later systems, PRI B-channels, T1-emulated tie voice channels, and T1-emulated data channels can be used as tandem trunks to link MERLIN LEGEND Communications Systems with one another or with DEFINITY ECS or DEFINITY ProLogix Solutions systems.

Release 2.0 and later systems also support call-by-call service selection for outgoing PRI calls, support for Station Identification/ANI (SID-ANI) as a Calling Party Number, and dial-plan routing.

Terminology

Called Party Number (CdPN)

In general, the term *Called Party Number* (CdPN) is a telephone number that has been dialed to reach a destination. While routing the call, however, the network can change the Called Party Number to make routing easier. In either case, the network sends the Called Party Number to the system when a call arrives at the system.

Calling Party Number (CPN)

If you subscribe to the AT&T INFO2 ANI service or another PRI caller identification network service (Release 4.2 and later), an incoming call on an ISDN line includes accompanying information about the party placing the call. This can be either a station (extension) identification number that is defined by the internal dial plan of the system where the call originated (*Extension Only*), billing number information (*Line Telephone Number*), or both (*Base Number with Ext.*). With this information, a call recipient may identify the caller before answering.

Lines/Trunks

In this section on PRI and T1, *lines* are the representations that appear on extension telephones or that are put into pools. They represent the type of service requested on a call. *Trunks* are the facilities that link switches. For all facilities except DS1, lines have a one-to-one correspondence to trunks because there are 24 transmission channels for each DS1 connection. With PRI, lines are further removed from trunks because the type of service is not linked to the B-channel (trunk). The system has an intermediary called a *B-channel group* (BCG). Lines are used to place and receive calls, and a BCG links B-channels to lines. B-channel groups may be either a single B-channel or multiple B-channels grouped together.

[Figure 26 on page 517](#) shows how lines, B-channels, and B-channel groups function together. For outgoing calls, a user selects a PRI line that routes the call to a B-channel group. The BCG selects an open B-channel and connects over the PRI connection. For incoming calls, the network selects an open B-channel and the BCG directs the call to the PRI line for which it has been intended: it matches the Called Party Number with the line's programmed telephone number. In addition, the Dial-Plan Routing feature may be used to further direct the call to a specific extension (SA button) or calling group by matching some portion of the Called Party Number against the system dial plan. Dial-plan routing is similar to Direct Inward Dial.

Each DS1 module is given 24 lines, whether or not it is used for emulation of lines/trunks or for PRI.

PRI

PRI is a common configuration for a DS1 facility. A DS1 facility consists of 24 channels, sometimes referred to as DS0 channels, each with a capacity of 64 kbps. DS1 refers to the twenty-four 64-kbps channels, plus framing and signaling bits, multiplexed together to form a 1.544-Mbps *Digital Signal Level 1* signal. When used for PRI, a channel can be designated as either a B-channel (*bearer channel*) or a D-channel (*data or delta channel*).

A B-channel is used to carry user information, such as the voice or data content of a call, between the system and the far-end switch. Each B-channel provides access to one or more network services. Releases 1.0 and 1.1 support access to only one network service for each B-channel. Release 2.0 and later supports call-by-call service selection, which allows multiple network services over the same B-channels. The D-channel conveys signaling required to set up, control, and clear calls made over all of the B-channels.

The most common configuration of a DS1 facility for PRI consists of 23 B-channels and 1 D-channel, although other combinations are possible. Each PRI must include a D-channel, but may include fewer than 23 B-channels. The remaining channels cannot be used for any other purpose.



NOTE:

The MERLIN LEGEND Communications System does not support multiple PRI facilities sharing one D-channel (as allowed with Non-Facility Associated Signaling).

Up to three DS1 carrier facilities (maximum of two in one carrier), and therefore three PRIs, can be connected to the system through separate 100D modules, each of which occupies a slot in the system carrier. In terms of system capacity, each DS1 channel counts as a line/trunk, so the maximum number of B-channels supported by the system is 69. Signaling for 69 B-channels is provided over three separate D-channels, using up 72 of the system's 80-line capacity.

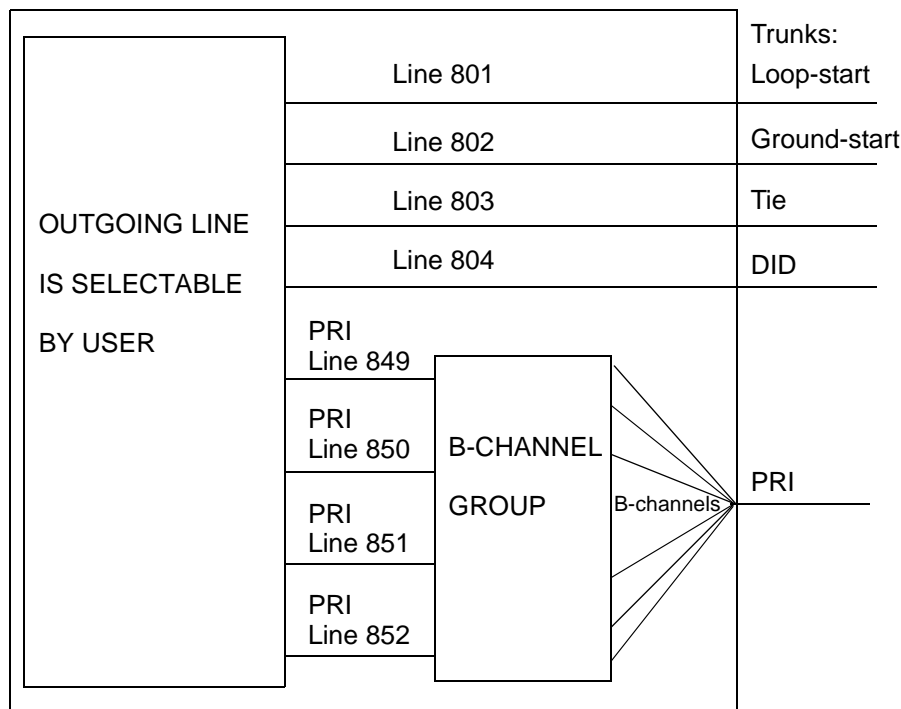

Figure 26. PRI Lines and B-Channel Groups

In Release 6.0 and later systems (Hybrid/PBX mode only), PRI tandem trunks are available to network MERLIN LEGEND Communications Systems with one another or with DEFINITY ECS and DEFINITY ProLogix Solutions communications systems, providing smoother operation, additional features, and easier management than the networking available in earlier releases. Tandem PRI trunks are private trunks that may use central office switches in the PSTN for amplification over long distances but do not use central office facilities for switching. For details, see [“Tandem PRI Trunks” on page 527](#).

PRI service offers the following benefits:

- Network Subscriber Service Options.** Release 4.2 and later systems support network services from AT&T, MCI, and the DMS-100 5ESS network of local exchange carriers. (Prior releases support AT&T subscriber 5ESS LEC subscriber services only.) These services are described in [“Type of Service” on page 522](#). In Release 6.0 and later systems, tandem networking is supported by using PRI, T1-emulated voice, and T1-emulated data trunks as tandem trunks in private networks of systems.

- **Speed.** Data calls to outside destinations can be established on the same B-channels used for voice calls if the service allows. Dedicated, conditioned lines/trunks are not needed. By supporting high-speed digital data transmission, PRI provides the capability for videoconferencing and Group IV (G4) fax.
- **Dynamic B-Channel Assignment.** An individual B-channel can be removed from service without blocking ISDN calls to or from any extension.
- **Improved Toll Restriction.** The ways that toll restriction can be bypassed are limited on PRI lines/trunks. Specifically, three types of toll abuse are eliminated with PRI service:
 - Because dialing is in the form of out-of-band messages that must be generated by the system, a user cannot use a touch-tone generating device, such as a pocket dialer, to send dialed digits directly through the system to the line/trunk.
 - Without PRI service, toll restriction can be deceived by dialing digits on a loop-start line before the far-end switch applies dial tone. These initial digits may indicate a local call to the system's toll-restriction checking while the subsequent digits, those actually recognized by the far-end switch, may produce a toll call. This is not possible with PRI service because every digit screened and passed on by the system's toll restriction is guaranteed to be received by the far-end switch.
 - A PRI line's far-end disconnect signal provides a reliable indication when a call ends, and a new call cannot be initiated until the line has been released from the prior call on both ends. This prevents a user on a loop-start line, waiting off hook for the restoration of dial tone after a previous call, from placing a second call before toll restriction is reapplied.
- **Reliable Indication of Far-End Disconnect.** This prevents an incoming call from being blocked because a line is not released when a call is ended.

The system's implementation of PRI provides the following features:

- **Support for Caller Identification.** The system supports AT&T's Automatic Number Identification (ANI) service and, in Release 4.2 and later systems, similar services from MCI and local exchange carriers. Customers who subscribe to one of these services can identify the incoming caller on a PRI line/trunk by telephone number or billing number. The ANI in Release 1.0 is facility-based, whereas it can be extension-based in Release 2.0 and later, if so programmed. Extension-based ANI results in a more PBX-like performance from the system.

**NOTE:**

The availability of the caller identification information may be limited by local-serving (caller's) jurisdiction, availability, or service provider. Blocking Caller ID is possible system-wide by accessing the PRI Lines menu. For information, see *System Programming*, Chapter 3, "Copy Telephone Number to Send."

- **Routing by Dial Plan** (Release 2.0 and later). Routing by dial plan supports call handling similar to DID. For example, you can specify that calls received from a particular area code should be routed to a specific person or group responsible for accounts in the area.

Routing by dial plan performs digit analysis on incoming calls, matches to Called Party Numbers (CdPNs), and delivers the calls to the destinations based on the respective Called Party Numbers. It also allows multiple calls to the same directory number—that is, multiple concurrent incoming calls with the same Called Party Number can be delivered to a destination simultaneously.

- **Call-by-Call Service Selection** (Release 2.0 and later). This feature maximizes use of communications lines, providing more services with fewer lines. Call-by-call service selection provides more than one PRI service (such as VPN service and OUTWATS) for each B-channel. Based on the number dialed and the bearer capability (voice, data, or both), the system chooses which service is used. If a caller requests operator service, the system bypasses call-by-call service selection.
- **Restriction Code Handling for FTS2000 Network** (Release 2.0 and later). FTS2000 network users can have restriction codes applied to their extensions. A person who attempts to place a call that exceeds the set restriction level must first enter a restriction code. If no code is entered, the FTS2000 network prompts the user to enter the code from the telephone dialpad. The system allows a restriction code to be entered with the Account Code Entry feature. This is especially useful for data calls.
- **Networked Tandem PRI Trunks** (Release 6.0 and later systems, Hybrid/PBX mode only). Networked PRI trunks allow cost-effective use of trunks by remote networked users, transparent dialing of extensions connected to networked systems, shared automated attendant systems under some conditions, and flexible display features for MLX display telephones. PRI dial plan routing is not applied to calls received on tandem PRI trunks. For additional information, see this section and ["Uniform Dial Plan Features" on page 741](#).

T1

A DS1 facility programmed as a T1 line/trunk uses 24 channels, sometimes referred to as *DS0 channels*, each with a capacity of 64 kbps. Signaling must be in-band signaling, however, which limits the data rate for each channel to 56 kbps when the channels are programmed for Switched 56.

In Release 6.0 and later systems, T1 channels can be programmed either to emulate voice tie trunks or data tie trunks. These trunks can be used as tandem trunks linking networked systems. In addition, you can use drop-and-insert equipment to supply fractional T1 use. See the *Network Reference* for more information.

T1 channels can be programmed to emulate the following types of connections:

- Loop-start
- Ground-start
- T1-emulated data (56-kbps data)
- Ear & Mouth (E&M) tie trunk
- Direct Inward Dial

T1 service provides the following benefits:

- **Speed.** Data calls to outside or network (Release 6.0 and later systems) destinations can be made by programming a channel for T1 Switched 56 Data. This service must be supported on the far end. By allowing high-speed digital data transmission, T1 provides the capability for videoconferencing and Group IV (G4) fax.
- **Improved Toll Restriction.** The ways in which toll restriction can be bypassed are limited on T1 lines/trunks. Specifically, three types of toll abuse are eliminated with T1 service:
 - Because dialing is in the form of out-of-band messages that must be generated by the system, a user cannot use a touch-tone generating device, such as a pocket dialer, to send dialed digits directly through the system to the line/trunk.
 - Without T1 service, toll restriction can be deceived by dialing digits on a loop-start line before the far-end switch applies dial tone. These initial digits may indicate a local call to the system's toll-restriction checking while the subsequent digits, those actually recognized by the far-end switch, may produce a toll call. This is not possible with T1 service because every digit screened and passed on by the system's toll restriction is guaranteed to be received by the far-end switch.

- A T1 line's far-end disconnect signal provides a reliable indication when a call ends, and a new call cannot be initiated until the line has been released from the prior call on both ends. This prevents a user on a loop-start line, waiting off hook for the restoration of dial tone after a previous call, from placing a second call before toll restriction is reapplied.

- **Reliable Indication of Far-End Disconnect.** This prevents an incoming call from being blocked because a line is not released when a call is ended.

T1 supports routing by dial plan on Switched 56 data channels that are connected to the public switched telephone network. Routing by dial plan supports call handling similar to Direct Inward Dial (DID). It performs digit analysis on incoming calls, matches to Called Party Numbers (CdPNs), and delivers the calls to the destinations based on the respective Called Party Numbers. It also allows multiple calls to the same directory number—that is, multiple concurrent incoming calls with the same Called Party Number can be delivered to a destination simultaneously.

**NOTE:**

In Release 6.0 and later systems, when T1-emulated tie facilities are used as tandem tie trunks, digit manipulation can be performed through UDP routing. See [“Uniform Dial Plan Features” on page 741](#) for details.

DS1 Facility Options

A Digital Signal Level 1 (DS1) facility is a transmission system that transports digital signals in the DS1 format. The interface that allows the connection of DS1 facilities to the system is the 100D module. Through this module, voice and data calls can be made or received using a DS1 facility.

Twenty-four Digital Signal Level 0 (DS0) channels, each operating at 64 kbps, plus framing bits, are multiplexed, forming a DS1 signal of 1.544 Mbps. Each DS0 channel within the DS1 signal corresponds to a logical port. Although there is only one physical jack, the 100D module supports up to 24 logical ports (one for each channel).

In DS1 format, calls to other digital PBXs or telephone company foreign exchanges (FXs) remain digital. Signals do not need to be converted to analog for acceptance by the connecting trunk, except for networked applications such as off-premises extensions or situations where your communications equipment does not allow a DS1 digital interface. In addition, the 100D module can be configured to work with T1 or PRI service.

To connect the 100D module to an outside DS1 facility, a channel service unit (CSU) is used. The CSU regulates the transmission into and out of the 100D module so that the module matches the transmission of the outside facility.

Both ends of the DS1 facility must be able to communicate. To ensure this, the following options are set during system programming to match the transmission of the outside DS1 facility:

- Type of service (T1 or PRI)
- Framing format
- Line coding
- Channel service unit
- Line compensation
- Clock synchronization
- Signaling mode (for T1 service only)

**NOTES:**

- Most of these settings are dependent upon the central office and the type of service (T1 or PRI) to which you subscribe.
- In Release 6.0 and later systems (Hybrid/PBX mode only), tandem PRI and tandem T1-emulated tie trunks are set up using type of service, framing format, line coding, line compensation, and clock synchronization options; they can use the same settings as other PRI and T1 tie trunks. For details, see *System Programming*.

Type of Service

The system supports two types of service for DS1 facilities: T1 and PRI. The 100D module can be programmed to operate in either type of service. T1 service transmits and receives voice and analog data, as well as digital data in Release 4.0 and later communications systems; PRI transmits and receives voice, analog, and digital data. Any combination of the following AT&T Switched Network (ASN) Services can be provided through a T1 or a PRI line/trunk:

- Megacom WATS service for domestic outgoing long-distance voice calls
- Megacom 800 service for domestic toll-free incoming voice calls
- Software-Defined Network (SDN) for voice and circuit-switched data calls
- MultiQuest® for 900 service numbers

PRI interacts with the ACCUNET Switched Digital Service for 56-kbps, 64-kbps restricted, and 64-kbps clear circuit-switched data calls. T1 supports ACCUNET Switched Digital Service or other circuit-switched data service at 56 kbps in Release 4.0 and later.

T1 and PRI support Shared Access for Switched Services (SASS), which allows both Megacom and Megacom 800 services to be offered over the same line. This

eliminates the need to have separate incoming and outgoing lines/trunks when these services are chosen.

In Release 4.2 and later systems, when PRI is selected as the type of service, any combination of the following MCI and local exchange carrier services are supported, in addition to the AT&T services supported in prior releases:

- MCI services include:
 - **MCI PRISM**. For domestic outgoing long-distance and international voice calls; domestic outgoing 56-kbps restricted as well as 64-kbps restricted or unrestricted circuit-switched data calls.
 - **MCI 800**. For domestic toll-free incoming voice calls.
 - **MCI Vnet**. For domestic incoming and outgoing voice calls; or for outgoing 56-kbps restricted as well as 64-kbps restricted or unrestricted circuit-switched data calls.
 - **MCI 900**. Providing 900 service numbers.
- The system supports the following local DMS-100 local exchange carrier services:
 - **Virtual Private Network (VPN)**. For calls between the MERLIN LEGEND Communications System and another communications system (for example, another MERLIN LEGEND Communications System).
 - **Maximal OUTWATS and INWATS**. For domestic outgoing long-distance voice calls (not including support for bands or zone); for domestic toll-free incoming calls.
 - **Foreign Exchange**. For local call rating of calls from the local exchange in the area served by the foreign exchange.
 - **Tie Trunk**. For private exchange call rating of calls placed on a dedicated central office facility between the MERLIN LEGEND Communications System and another MERLIN LEGEND Communications System.
 - **Integrated Services Access** (also called *call-by-call service selection*). Allows a B-channel group to carry a variety of local services.

T1 is the factory setting and, when selected for the DS1 facility, allows each of the 24 channels to be programmed to emulate tie (emulated voice or Switched 56), loop-start, ground-start, or DID lines or to provide Switched 56 data-only service in any combination. A single 100D module, therefore, can take the place of 24 regular outside lines/trunks.

In Release 6.0 and later systems (Hybrid/PBX mode only), T1-emulated voice tie channels and T1-emulated data tie channels can be used to connect MERLIN LEGEND Communications Systems with one another and/or with DEFINITY ECS and DEFINITY ProLogix Solutions communications systems in private networks.

They act as tandem tie trunks. If the type of service desired is PRI, tandem PRI trunks can perform the same function. (See [“Tandem PRI Trunks” on page 527.](#))

If common-channel signaling (CCS) is selected, 23 channels are available for emulation, and the twenty-fourth channel carries trunk supervision signals. (See [“Signaling Mode” on page 526.](#))

Framing Format

To identify the DS0 channels, the DS1 signal is segmented into blocks of 193 bits called *frames*. A frame consists of 24 eight-bit words (one for each channel) plus a framing bit at the beginning of each frame (24 words x 8 bits = 192 bits). Thus, a framing bit appears in every one hundred ninety-third bit position of the 1.544-Mbps DS1 signal.

Frames repeat at a rate of 8,000 per second. Each frame repeats DS0 channels 1 through 24 sequentially.

The following two methods of framing can be used by a 100D module, but the framing method chosen must match the framing at the far end:

- **D4 Framing Format.** The system is factory-set for D4 framing. A D4 frame consists of 24 eight-bit time slots and one framing bit. To perform synchronization, the receiving equipment uses the framing information to identify the start of each frame and to identify which frames contain signaling information. The framing information repeats once every 12 frames; these 12 frames form the D4 superframe.
- **ESF Framing Format.** The extended superframe (ESF) format extends the 12-frame D4 superframe to a 24-frame superframe. The 24 framing bits include a cyclic redundancy check (CRC) for the entire ESF and a facility data link for maintenance. The ESF can detect more errors than D4 framing can. In Release 6.0 and later systems (Hybrid/PBX mode only), use this format for tandem trunks.

Line Coding

The DS1 signal consists of a continuous stream of ones and zeros, encoded into bipolar pulses for transmission. Only the ones create a pulse; the zeros represent the absence of a pulse. Pulses alternate between positive and negative. This type of line coding is called *bipolar* or *alternate mark inversion* (AMI). The line-coding formats guarantee that the ones-density requirement is met to achieve clock recovery.

To meet the ones-density requirement, either zero code suppression (ZCS) or bipolar 8 zero substitution (B8ZS) line coding can be chosen, but the selected line coding must match the line coding at the far end. In Release 6.0 and later systems (Hybrid/PBX mode only), use this coding for tandem trunks.

ZCS line coding monitors each DS0 channel and prevents strings of eight or more zeros. Upon detecting eight consecutive zeros in a channel octet, ZCS line coding forcibly changes the seventh zero (the second least significant bit) to a one. The factory-set line coding is ZCS.

B8ZS line coding matches the ones-density requirement by using a special sequence with a *bipolar violation* in bit positions 4 and 7. Normally, for bipolar transmission, ones are encoded alternately as a positive then negative, or negative then positive, pulse. If two positive or two negative pulses are received in succession, a bipolar violation occurs. Bipolar violations are normally caused by noise hits to the signal; however, B8ZS uses a specific binary sequence with bipolar violations as a code for an all-zero channel octet.

B8ZS line coding is preferred over ZCS because it provides no possibility of corrupting data transmissions.

B8ZS violations are passed by the ACCULINK™ 3150 and 3160/3164, and ESF T1 channel service units (CSUs) but not by other CSUs.

Channel Service Unit

The channel service unit (CSU) is the interface between the 100D module and the DS1 facility provided by the telephone company. This facility contains 24 channels on one 4-pair wire.

The CSU is a hardware component needed when two endpoints are located in different buildings or when the distance between the two endpoints makes office or line repeaters necessary. The CSU is located on the customer's premises and is used to connect the system to DS1 network facilities. The CSU has the following functions:

- It terminates an outside DS1 facility on the 100D module.
- It ensures that the signals entering the public network comply with the requirements of the DS1 facility as specified by the FCC.
- It includes maintenance, diagnostic, and testing capabilities.



NOTE:

Verify that any CSU on the DS1 circuit between the MERLIN LEGEND Communications System and the PSTN is programmed for the same framing as the DS1 slot on the MERLIN LEGEND Communications System.

There are several channel service units: ACCULINK 3150 and 3160/3164 ESF T1 CSUs, ESF T1 CSU (no longer available but still supported), and 551 T1 L1 CSU (no longer available but still supported). The ACCULINK 3150 or 3160/3164 CSUs are recommended for this system because they allow maintenance without

interrupting service and provide diagnostic and testing capabilities as well as B8ZS line coding. They can be programmed remotely or onsite, using menus. The lower-cost 551 T1 L1 CSU does not provide the B8ZS line coding required for 64-kbps data (clear channel signaling support) and for maintenance features, nor does it provide diagnostic and testing capabilities for the DS1 facility.

Line Compensation

Line compensation adjusts for the amount of cable loss, in decibels (dBs), based on the length of cable between the 100D module and the CSU or other far-end connection point. The factory setting is a value of 1, which allows a maximum loss of 0.6 dB. The possible settings are shown in [Table 31](#).

Table 31. Line Compensation Settings

Setting	dB Loss	Cable Length (22-Gauge Wire)
1	0.6	0–133 feet (0–40.5 meters)
2	1.2	133–266 feet (40.5–81 meters)
3	1.8	266–399 feet (81–121.5 meters)
4	2.4	399–533 feet (121.5–162 meters)
5	3.0	533–655 feet (162–199.5 meters)

Signaling Mode

Signaling is the process of communicating channel-state information, such as dialing, from endpoint to endpoint. Two types of signaling can be used in T1 transmission: robbed-bit signaling (RBS) and common-channel signaling (CCS). Choosing a signaling mode is important only for T1 service; PRI always uses CCS (23 B-channels and 1 D-channel). The signaling types are as follows:

- **Robbed-Bit Signaling.** Robbed-bit signaling (RBS) replaces the least significant bit in every sixth frame of each DS0 channel with signaling information. RBS is also called *in-band signaling* because signaling information is embedded in the same channel that carries the user's voice or data in a call. Robbed Bit Signaling must be used if T1 Switched 56 service is to be used on the T1 connection.

Robbed-bit signaling is appropriate for voice and voice-grade data, and digital data on channels programmed for T1 Switched 56 service.

- **Common-Channel Signaling.** Common-channel signaling (CCS) is an out-of-band signaling format that places the signaling bits for channels 1 through 23 into the 8-bit word of the twenty-fourth channel. This restricts DS1 from using the twenty-fourth channel for voice or data transmissions. D4 framing does not preclude the use of CCS, but CCS is not compatible with D4 channel banks because the D4 channel banks recognize only RBS. CCS is used when PRI service is desired on the DS1 facility.



NOTE:

If you have a 100D module with an apparatus code of 517M15 or later, common-channel signaling is not an option for T1.

ESF framing should be used because of its improved maintenance, diagnostic, and testing capabilities. If the transmission between two systems is voice-only, RBS should be used for all 24 communications paths. For voice transmissions, both ZCS and B8ZS line coding can be used to satisfy the ones-density requirement: the preferred line-coding format is B8ZS, which is needed for 64-kbps digital data.

The framing and signaling formats depend on the network and interconnection devices (CSUs) used. For example, the 551 T1 L1 CSU supports only ZCS.



NOTE:

Through PRI, digital data using up to 64 kbps is possible only when using a DS1 facility; connections of up to 64 kbps for each channel are also possible on BRI connections in Release 4.0 and later systems. Also, ESF framing mode, CCS signaling, and B8ZS line coding are required. An ACCULINK 3150/3160/3164 or ESF-T1 CSU must be used for DS1 connections within a building.

Tandem PRI Trunks

In Release 6.0 and later systems (Hybrid/PBX mode only), you can network MERLIN LEGEND Communications Systems with one another and/or with DEFINITY ECS or DEFINITY ProLogix Solutions systems. Tandem PRI and tie trunks (T1-emulated voice/data or analog) are supported as private network lines/trunks. PRI private trunks provide the most features and advantages. This topic outlines the general considerations for setting up such trunks. Details are provided in *System Programming* and in other sections of this guide as noted. Full information about private networks is presented in the *Network Reference*.

PRI tandem trunks provide the following benefits:

- **Transparent Dialing of Extension Numbers on Remote Systems.** Using PRI tandem trunks, T1, or analog tie trunks for networking, a dial plan that provides access to remote extensions is set up locally. This allows calls to extensions on a remote system to be dialed using SA or Shared SA buttons.
- **Cost-Effective ARS Dialing from a Remote System.** Using tandem PRI trunks or tandem tie (analog, or T1-emulated voice or data) trunks for networking, users can dial ARS calls normally. The local ARS is set up to route calls through the system that provides the best cost benefit. For example, if the local system is in the 908 area code and a remote

networked system is in the 415 area code, calls made from the local system to the 415 area code can be routed through the remote system. This can mean considerable toll savings.

- **Faster Data Transmission.** Networked PRI tandem trunks support digital data speeds of up to 128 kbps between networked systems for enhanced 2B data videoconferencing and other data applications. Earlier releases permit a maximum speed of 112 kbps between connected systems. T1-emulated data channels, when used as tandem trunks, allow speeds of up to 112 kbps.
- **Incoming Call Display.** For MLX display telephone users, the system manager may program the incoming call display to allow alphanumeric labels, extension numbers, or both to be shown for calls routed among networked systems on tandem PRI facilities. For additional information, see [“Uniform Dial Plan Features” on page 741](#) and [“Display” on page 271](#).
- **Fractional Use Support.** You can tailor your use of PRI B-channels with drop-and-insert equipment that allows fractional use of B-channels for non-MERLIN LEGEND data/video communications between sites at 64 kbps per channel, while keeping the remaining B-channels for MERLIN LEGEND PRI voice/data traffic. The PRI D-channel must remain active. The system also allows this type of fractional use of T1 circuits programmed as T1-emulated tie and tandem trunks.

Tandem PRI Trunk Programming

In Release 6.0 and later systems (Hybrid/PBX mode only), two PRI Switch Type options allow you to set up a PRI tandem trunk that connects two MERLIN LEGEND Communications Systems or a MERLIN LEGEND Communications System and a DEFINITY ECS or DEFINITY ProLogix Solutions system. The two additional programming options are LEGEND-Ntwk and LEGEND-PBX. One system is specified as operating in PBX mode and the other as operating in networked mode. When both systems are MERLIN LEGEND Communications Systems, it is not significant which system is assigned which switch type, only that they are opposites. When you program this switch type, it is important to specify the type of switch at the *other* end of the PRI trunk, not the local switch.

DEFINITY ECS and DEFINITY ProLogix Solutions systems do not have a Switch Type setting. The Interface field on such a system identifies the type of the DEFINITY ECS or DEFINITY ProLogix Solutions system, not the type at the other end of the tandem trunk as on MERLIN LEGEND Communications Systems. If the Interface field specifies *Network*, as it typically might, the connected MERLIN LEGEND Communications Systems specify LEGEND-Ntwk. If the Interface field specifies *User*, the connected MERLIN LEGEND Communications Systems are programmed with the LEGEND-PBX setting.



NOTE:

DEFINITY ECS and DEFINITY ProLogix Solutions features and operations are beyond the scope of this guide. For information about these systems, consult their documentation.

When you specify one of these two switch types at a MERLIN LEGEND Communications System, the system's automatic assignment algorithm performs the following actions to set up the PRI tandem trunk:

- A single unused B-channel group number is automatically assigned with all 23 B-channels on the trunk; B-channels may be removed or added subsequently. To find an unused group, the system starts at group 80 and searches backward.
- PRI dial plan-routing does not apply for incoming calls on the trunk. Instead, incoming routing is automatically set to Route Directly to UDP; this cannot be changed as long as the LEGEND-PBX or LEGEND-Ntwk switch type is in effect.
- PRI outgoing tables do not apply to outgoing calls on the trunk. ARS or Remote Access features can be used.
- The system automatically assigns Electronic Tandem Network (ETN) as the network service for the B-channel group that is assigned to the PRI tandem trunk; this setting cannot be changed as long as the switch type is in effect.
- The Copy Telephone Number to Send setting is set to Copy for the PRI tandem trunk B-channel group; this setting cannot be changed as long as the switch type is in effect.

PRI Programming Options

The following options should be programmed for PRI facilities connected to a 100D (DS1) module.



NOTE:

In Release 6.0 and later systems (Hybrid/PBX mode only), some options are set up automatically for PRI tandem trunks and cannot be changed unless the switch type is also changed. See the previous topic for additional information.

PRI Telephone Number

The PRI telephone number is a string of up to 12 digits (any combination of digits 0–9) assigned to each PRI line. This string is matched to the Called Party Number sent by the network to indicate the number dialed by the outside caller. The system uses this number to send the call to the correct personal line button.

Network Services Supported

This option specifies the type of network service provided by each B-channel group. The choices are as follows:

- AT&T toll services:
 - Megacom WATS
 - Megacom 800
 - MultiQuest
 - ACCUNET Switched Digital Service (SDS)
 - Software-Defined Network (SDN)
- Local services:
 - OUTWATS
 - INWATS
 - 56/64 Digital Data
 - Virtual Private Network
- In Release 4.2 and later systems, these MCI services are also available:
 - MCI PRISM
 - MCI Vnet
 - MCI 800
 - MCI 900
- In Release 4.2 and later systems, these local exchange carrier services are also available:
 - DMS Private
 - DMS INWATS
 - DMS OUTWATS
 - DMS FX
 - DMS Tie Trunk
- In Release 6.0 and later systems (Hybrid/PBX mode only), where the Switch Type setting is LEGEND-Ntwk or LEGEND-PBX, the network service is automatically set to Electronic Tandem Network (ETN) and cannot be changed unless the Switch Type setting is modified.

Copy Telephone Number to Send

This option specifies whether or not the telephone number to send to the network for outgoing calls made on PRI lines assigned to a B-channel group is copied from the PRI telephone number assigned to that PRI line. Select the Copy Telephone Number to Send option when the telephone number sent to the network should match the number received from the network, indicating the number dialed by the outside caller. Select the Do Not Copy Telephone Number option either when a

telephone number to send is assigned to each PRI line in the B-channel group or when no telephone number is to be sent to the network. (This can be used to block outgoing Caller ID, systemwide.)



NOTE:

In Release 6.0 and later systems (Hybrid/PBX mode only), where the Switch Type setting is LEGEND-Ntwk or LEGEND-PBX, the Copy Telephone Number to Send option is set to Copy and cannot be changed unless the Switch Type setting is modified.

Telephone Number to Send

This option assigns the telephone number to send to the network when outgoing calls are made on PRI lines. If the person being called subscribes to a PRI caller identification service, the number indicates who is calling.

Test Telephone Number

This option assigns a test line telephone number for each 100D (DS1) module installed in the control unit that provides ISDN PRI service.

Timers and Counters

This option sets the timer and counter thresholds. The factory settings for thresholds are standard and rarely need to be changed. (See [“At a Glance” on page 509](#) for factory settings and valid ranges.) When no response is received from the network before the duration of the timer setting, the communications system takes appropriate corrective action.



CAUTION:

After initial installation, these timers rarely, if ever, should be changed.

The timers and counters are as follows:

- **T200 Timer.** Times the delay in link layer acknowledgment of a message sent from the communications system to the network over a D-channel.
- **T203 Timer.** Times the period of time between each exchange of messages between the system and the network on the D-channel.
- **N200 Counter.** Counts the number of times the communications system has transmitted a message on a D-channel because no link layer acknowledgment is received from the network.
- **N201 Counter.** Counts the maximum number of layer 3 octets the system can send or receive in a single D-channel message.
- **K Counter.** Counts the number of layer 3 unacknowledged messages sent from the communications system to the network on a D-channel.

- **T303 Timer.** Times the delay in network response when the system sends a setup message to initiate an outgoing call.
- **T305 Timer.** Times the delay in network response when the communications system sends a disconnect message to clear a call.
- **T308 Timer.** Times the delay in network response when the communications system sends a release message to clear a call.
- **T309 Timer.** Times the duration of a D-channel data link failure (a loss of signaling for the entire PRI connection).
- **T310 Timer.** Times the network delay following the receipt of a call-proceeding message on an outgoing call.
- **T313 Timer.** Times the delay in network response when the communications system sends a connect message that indicates the completion of an incoming call.
- **T316 Timer.** Times the delay in network response when the communications system sends a restart message to clear a B-channel.

Terminal Equipment Identifier (TEI)

This option assigns the link layer address of devices connected to each D-channel. Usually, only one is connected; the network assumes that its TEI is 0.

PRI Call Processing

[Figure 27 on page 533](#) shows the order of call processing for both incoming and outgoing calls on PRI facilities connected to the public switched telephone network; the section of the figure within the box applies specifically to call processing on a system with PRI. An explanation of incoming and outgoing call processing follows.

Incoming Calls

In Release 1.0 and 1.1 systems, incoming calls are routed by line appearance. Beginning with Release 2.0, incoming calls also can apply routing by dial plan, a routing system for incoming calls programmed by the Dial-Plan Routing Table (see [Table 32 on page 535](#)).



NOTE:

In Release 6.0 and later systems (Hybrid/PBX mode only), where the Switch Type setting is LEGEND-Ntwk or LEGEND-PBX for a PRI trunk, incoming calls are automatically set to Route Directly to UDP. PRI routing by dial plan and line appearance are not used. This cannot be changed unless the Switch Type setting is modified.

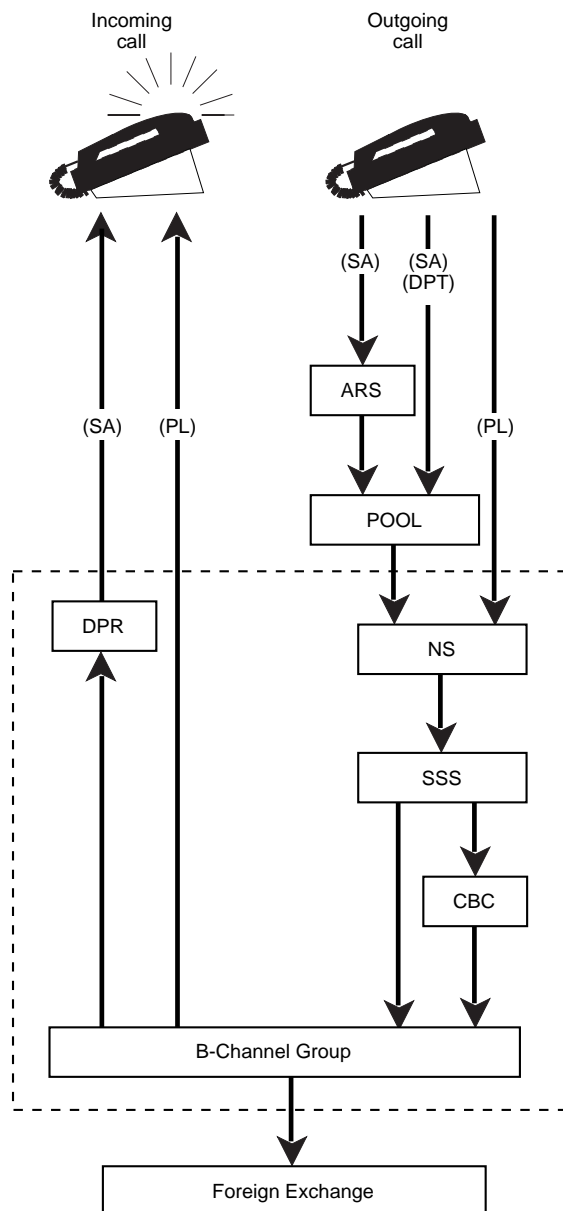

Where:

ARS = Automatic Route Selection	DPR = Dial Plan Routing Table	NS = Network Selection Table
CBC = Call-by-Call Services Table	DPT = Direct Pool Termination	SA = System Access
PL = Personal Line		SSS = Special Services Selection Table

Figure 27. PRI Call Processing (Non-Tandem Only)

Routing by Dial Plan (Hybrid/PBX Only). Routing by dial plan is similar in concept to Direct Inward Dial (DID). It provides the ability to direct a call automatically to the proper destination for improved call distribution and call handling. Unlike a DID line, a PRI line (or T1 line in Release 4.0 or later) programmed for routing by dial plan can accommodate outgoing calls as well as incoming calls. As with DID operation, this feature is available only in Hybrid/PBX mode.

PRI Routing by Dial Plan. Routing by dial plan also allows multiple calls to a directory number. Concurrent incoming calls with the same Called Party Number can be delivered to a destination simultaneously.

The Dialed Number Identification Service (DNIS) is a service attribute of the Megacom 800 service. Based upon customer-selected parameters, such as area code, state, or time of call, it provides distinct Called Party Numbers for incoming 800 and 900 calls. In Release 1.0 and 1.1 systems, DNIS has the restriction of one active call per Called Party Number for each B-channel group. The PRI telephone number, which is matched against the Called Party Number (CdPN), is used for routing a call to a specific line that normally terminates on a personal line button. In Release 2.0 and later systems, the restriction of one active call for each CdPN does not apply.

For each B-channel group, the system can be programmed for either routing by line appearance or routing by dial plan. With routing by dial plan, the Dial-Plan Routing Table must be programmed to contain a series of patterns—the number of digits in the CdPN, network services on which to match, and a number of digits to add or delete for each match—in order to route the call to the proper destination.

If a B-channel group is programmed for routing by dial plan, all incoming calls to that B-channel group are routed in a DID-like manner and terminate on an SA button, on a single-line telephone, into a calling group queue, or at a Queued Call Console (QCC). When an incoming call arrives, its network service type and CdPN are compared to entries in the Dial-Plan Routing Table. If no match is found, the call is routed to the programmed backup position for unassigned DID calls (normally the primary system operator). If a match is found, the CdPN is manipulated according to the Dial-Plan Routing Table before matching it against the inside dial plan to identify a destination to which the call is delivered. If the manipulated CdPN does not match an inside extension, it is treated as an unassigned DID call.

If a fast busy tone is programmed as the routing destination for unassigned Direct Inward Dial calls, the call is rejected. This typically causes the network to return an intercept tone instead of a fast busy tone. If the number matches a destination that DID calls are not permitted to reach (for example, pool access codes, group page codes, line access codes, or the ARS access code), the call is routed to the programmed destination for unassigned DID calls (unless the backup is a fast busy tone).

[Table 32](#) is a sample Dial-Plan Routing Table. Note that in the sample table all incoming calls through the Megacom 800 service are delivered to an extension whose dial-plan number is 1234. Entry 15 would be skipped because No Service is specified.

Table 32. Sample PRI Dial-Plan Routing Table

Entry	0	1	2	3...	15
Service	SDN	SDN	MEG800		No Service
# of digits in CdPN	7	10	10		[not specified]
Example #	555-1234	908-555-1234			
Pattern	555	[none]	[none]		[none]
Digit deletion	3	6	10		14
Digit addition	[none]	[none]	1234		0

When routing by dial plan is used for an incoming call, if the programmed service, number of digits in the Called Party Number (CdPN) and patterns match those associated with the incoming call, the appropriate digit deletion and addition are performed. The process is as follows:

1. The programmed service is compared with the B-channel service, if supplied. A match is found if the two services are equivalent or if the programmed service in the Dial-Plan Routing Table is All Services. If a match is found, the system continues to search the entry. If no match is found or if No Service is specified, the system skips the entry and proceeds to the next one. If no service is supplied, the call is matched to No Service table entries.
2. The programmed number of digits is compared with the number of digits in the actual Called Party Number. A match is found if the two numbers are equivalent or if the programmed number of digits is 0. If a match is found, the system continues to search the entry. If no match is found, the system skips the entry and proceeds to the next one. If the programmed number of digits is 0, any number of digits in the Called Party Number is acceptable.
3. The programmed pattern is compared with the digits associated with the incoming call. If the pattern matches, the entry is tagged as a possible best match for the incoming call. It is possible that more than one entry can match the incoming call; the entry chosen is the one that matches on the greatest number of digits in the pattern. For example, if 555-2000 is the Called Party Number and the two patterns that match are 555 and 5552,

the entry associated with 5552 is chosen as the best match. If the pattern is not programmed, it is considered a match with the number of digits in the pattern equal to 0.

4. After the table is scanned and the best match is found, the programmed digit manipulation (addition and/or deletion) associated with the entry is performed. If the digit manipulation results in an invalid dial-plan extension, the call is routed to the destination for unassigned DID calls.



NOTE:

In Release 6.0 and later systems (Hybrid/PBX mode only), when a call arrives on a dial-plan routed PRI facility and its digits match an extension on the non-local dial plan, the call is routed to the appropriate non-local extension.

Characteristics and valid entries for the Dial-Plan Routing Table are as follows:

- The factory-set table value for service is Empty (not specified). Entries that remain empty are skipped when the system searches for a match.
- There can be up to 16 entries (0 through 15).
- The service can be specified as any one of the supported services, Other, No Service, or All Services.
- If the service is programmed as All Services, it matches any input and thus acts as a wild card. If the B-channel receiving the incoming call is also programmed for call-by-call service selection, the system retrieves the service type as supplied by the FX because an incoming call could be arriving on any of the services.
- An entry programmed for No Service matches calls in which no service is supplied by the foreign exchange or B-channel group.
- Each pattern can have 0 through 8 digits. The default is blank.
- The number of digits can be 0 through 14. A value of 0 in the table represents “any number” and thus acts as a wild card. The default number of digits is 0.
- The maximum number of digits to delete is 14.
- The digits to add include the digits 0 through 9. The length of this item is 0 through 4 digits. The default is blank.
- The digit count and pattern are optional. When not programmed, they are considered wild cards that match any input.

Display Operation. The telephone display provides call-related information about incoming PRI calls delivered over the B-channel, if available. Otherwise, it displays the line label and the digits dialed.

Beginning with Release 3.0, hyphens are inserted between the digits on incoming calls (for example, 555-1234 for a 7-digit display and 123-555-1234 for a 10-digit display). Any other number of digits appears without hyphens.

A brief description of the display support for incoming calls provided in Release 2.0 and later follows (see [“Display” on page 271](#) for additional details).

**NOTE:**

PRI display support for Release 2.0 and later applies to MLX, ETR, and MLS display telephones. There is no PRI display support for analog multiline telephones.

- **All Incoming PRI Calls.** When the calling party information is available from the network, the Automatic Number Identification (ANI) number appears on the user's display. This is the number of the calling party. Pressing the More button shows the Called Party Number on the second screen of the display. If the Called Party Number is more than 15 characters in length, the digits at the end are dropped.
- **Group Calling.** The MLX or ETR display telephone of a calling group member shows the original Called Party Number (before digit analysis). The same display applies to PRI calls routed by dial plan to a group calling member extension. Pressing the More button shows the ANI number on the second screen of the display.
- **Transfer without Consultation.** In Release 2.0 and later systems, pressing the More button on an MLX or ETR display telephone that is a transfer destination shows the original Called Party Number (before digit analysis). The same display applies to transferred PRI calls routed by dial plan.

In Release 6.0 and later systems (Hybrid/PBX mode only), display preferences for incoming calls are set up by using the Extensions menu. This setup affects calls arriving on tandem PRI trunks. You can set up MLX and ETR display telephones to display the extension number of the caller on the remote system, the programmed label, or both the label and the extension number. If ANI/ICLID information is provided for an outside call, it appears instead of the extension number and/or label. See [“Display” on page 271](#) for additional details.

Outgoing Calls

Call-by-call service selection is a feature for outgoing calls in Release 2.0 and later. It allows a group of B-channels to carry a variety of supported PRI services programmed in the Call-by-Call Services Table (see [Table 35 on page 540](#)). The service selected is based on the digits dialed and the bearer capability (voice, data, or both) of the originating party. In Release 1.0 and 1.1 systems, an outgoing call is carried on a static B-channel—that is, a B-channel dedicated to one specific service.

**NOTE:**

In Release 6.0 and later systems (Hybrid/PBX mode only), where the Switch Type setting is LEGEND-Ntwk or LEGEND-PBX, outgoing calls on tandem PRI trunks are not routed using the features outlined in this section. Instead, Remote Access and/or ARS can be used for such routing, as well as UDP routing (see [“Uniform Dial Plan Features” on page 741](#)) for calls to extensions on networked switches. This cannot be changed unless the Switch Type setting is modified.

Outgoing calls can be made by accessing a personal line, a Pool, or ARS. When a call is placed, the system determines whether the line accessed is a PRI facility. If so, the system performs digit analysis with the entries in the Network Selection Table (see [Table 33 on page 539](#)) and the Special Services Selection Table. The Network Selection table lists the prefixes for dial access to alternative long-distance carriers (for example, 10xxx). The Special Services Selection Table (see [Table 34](#)) lists prefixes that represent special services, such as operator service or international dialing (0 or 00).

In addition, if the B-channel group for an outgoing call is programmed for call-by-call service selection, the system performs *digit analysis*, with the entries in the Call-by-Call Services Table (see [Table 35 on page 540](#)). The entries in this table indicate the service and tell the system how to delete digits and successfully route an outgoing call.

A sample of each of these tables follows. Refer to *System Programming* for information about programming these tables.

Network Selection Table. The Network Selection table lists the prefixes for dial access to alternative long-distance carriers (for example, 10xxx). If multiple entries in the Network Selection Table match the dialed number, the one with the most non-wild card digits prevails. If the first digits of a dialed number (on PRI) match any entry in this table, the entry pattern is deleted from the dialed number and the number represented by the asterisks is used as the network selected. Characteristics and valid entries for the Network Selection table are as follows:

- There can be up to four entries (0 through 3).
- The pattern can be up to eight digits.
- An asterisk (*) is a wild card.
- The pattern cannot begin with an asterisk but must contain at least one.
- All asterisks must be at the end of the pattern and contiguous.

Table 33. Sample Network Selection Table

Entry Number	0	1	2	3
Pattern	101****	10***		

The Special Services Selection Table (see [Table 34](#)), lists prefixes that represent special services, such as operator service or international dialing (0 or 00). If multiple entries in the Special Services Selection Table match the dialed number, the one with the most digits prevails. Characteristics and valid entries are as follows:

- There can be up to eight entries (0 through 7).
- The pattern can be up to four digits (no wild cards).
- The choices for Operator are Operator (OP), Presubscribed Common Carrier Operator (OP/P), and None.
- The choices for Type of Number are National (N) and International (I).
- The number of digits to delete can be from 0 to 4.

Table 34. Sample Special Services Selection Table

Entry Number	0	1	2	3	4	5	6	7
Pattern	011	010	01	00	0	1		
Operator	None	OP	OP	OP/P	OP	None	None	None
Type of Number	I	I	I	N	N	N	N	N
Digit Deletion	3	3	2	2	1	1	0	0

Where:
 OP = Operator
 OP/P = Pre-subscribed Common Carrier Operator

Call-by-Call Services Table. When a call is placed on a call-by-call B-channel group, the dialed number and type of call must match one of the entries, the specified number of digits is deleted, and the specified service is selected. Similar patterns for the same type of call are permissible in this table; in such a situation, the feature selects the entry with the longest matching pattern. For example, based on the entries in [Table 35](#) and a voice call with a Called Party Number (CdPN) of 908957, Entry 1 is selected, not Entry 2. The last entry is used if the patterns are of equal matching digits.

For each entry, the following can be specified: a set of patterns, the type of call, the service to use, and the number of digits to delete.

Characteristics and valid entries for the Call-by-Call Services Table are as follows:

- By default, the patterns are blank, Call Type is Both, Service is blank, and Delete Digits is 0.
- There can be up to 10 entries (0 through 9).
- Each entry can contain up to 10 patterns of up to eight digits each.
- The number of digits to delete can be from 0 through 8 (default is 0).
- The user can use an entry as a default by selecting a Call Type and Service and not specifying any patterns.
- If Service is null (not selected), the entry is ignored. Null and No Service are not equivalent.

Table 35. Sample Call-by-Call Services Table

Entry Number	0	1	2	3	4	5-9
	700	908957	908			
		908949				
Patterns		908615				
		303843				
Call Type	DATA	BOTH	VOICE	VOICE	DATA	BOTH
Service	ACCUNET	SDN	MEG WATS	MEG WATS	SDN	
Delete Digits	0	0	0	0	0	0

Call-by-call service selection closely resembles ARS in reducing costs and maximizing the benefits derived from limited resources. While ARS selects the most cost-effective route, call-by-call service selection selects the optimal service for that particular call. Call-by-call service selection is integrated with ARS by including the bearer capability of the calling party in its routing decisions. ARS serves as the main gateway for accessing the call-by-call B-channel group. The basic calling process for call-by-call service selection with ARS is as follows:

1. A user dials ARS.
2. ARS selects the route and, in this case, the route points to a call-by-call B-channel group.
3. ARS performs digit deletion/addition operations for the route and, in so doing, may indirectly specify the best service for the call.
4. With these ARS outgoing digits, the call-by-call B-channel group selects the service, possibly based on digits added by ARS, and performs digit deletion as required.
5. A call setup message is sent to the network/central-office switch.

Restriction Code Handling for FTS2000 Network. FTS2000 network users can have restriction codes applied to their extensions. A person who attempts to place a call that exceeds the set restriction level must first enter a restriction code. If no code is entered, the FTS2000 network prompts the user to enter the code from the telephone dialpad.

Prior to Release 2.0, the restriction codes are input in-band (using touch-tones). In Release 2.0 and later systems, the system allows a restriction code to be entered with the Account Code Entry feature. This is especially useful for data calls because there is no in-band signaling to interfere with the data, since the restriction code is sent out of band in the setup message.

Station Identification-Automatic Number Identification (SID-ANI) as Calling Party Number. In Release 1.0 and later systems, facility-based information is used by the network for sending the Calling Party Number. If the SID-ANI option is programmed (and the service subscribed to), Release 2.0 and later systems send a systemwide base number of up to 12 digits, of which the final digits (up to 4 digits) are replaced with the number of the extension from which the call was made. For example, a call made from extension 7104 with a systemwide base number of 908-555-7000 sends the number 908-572-7104. For facility-to-facility calls where there is no call-originating extension (for example, Remote Call Forwarded calls), the systemwide base number is substituted. Trunk-to-trunk transfer, however, results in a CPN that consists of a base number in which the last digits are replaced by the number of the transferring extension.

In some instances, the systemwide base number is not sufficient to cover all extension numbers in the system. For example, the base number might be 908-555-7000 and there might be a group of extensions, 7000 through 7099, that correspond to telephone numbers from 908-555-7000 to 908-555-7099; there might be another group of extensions numbered 300 through 399 whose telephone numbers are 908-555-0300 through 908-555-0399. In a case like this, there is no base number that can cover all of the extensions so that the number sent is the correct number for the extension.

In Release 4.2 and later systems, the MERLIN LEGEND Communications System's PRI support for calling party identification extends to MCI and local exchange (DMS-100) subscription services.

T1 Programming Options

DS1 facilities programmed as T1 lines/trunks can supply many types of connections. T1 service transmits and receives voice and analog data as well as digital data in Release 4.0 and later communications systems. The connections can be to the PSTN, or they can be tie trunks connected to other MERLIN LEGEND Communications Systems or other PBX systems.

T1 Switched 56 channels connected to the PSTN can use routing by dial plan to send incoming calls to the correct data extension.

T1 Tie Trunk Connections

T1 trunks can be used to supply digital-emulated, tie trunk connections. These trunks can connect two MERLIN LEGEND Communications Systems or can connect one MERLIN LEGEND Communications System to another type of PBX (for instance, a Lucent Technologies DEFINITY G1.1 or DEFINITY ECS) or to the central office with digital (Switched 56 kbps) connections. In Release 6.0 and later systems, both T1-emulated voice tie lines and T1 Switched 56 tie lines can be used as tandem trunks to link MERLIN LEGEND Communications Systems with one another or with DEFINITY ECS or DEFINITY ProLogix Solutions communications systems.

Tie trunk settings for these connections are similar to standard analog tie trunks. The only difference between setting up a digital-emulated, tie trunk and an analog tie trunk is that the Signaling Type setting (Type 1 Standard, Type 1 Compatible, Type 5 Simplex) is not meaningful.

Direction. The tie trunk direction may be programmed in one of the following ways:

- **Two-way** (factory setting). Calls can be made in both directions. In networked Release 6.0 and later systems, use this setting for tandem tie trunks.

- **Outgoing Only.** Only outgoing calls can be made.
- **Incoming Only.** Calls can be received only.

Trunk Seizure Type. The trunk seizure type can be one of four settings. The setting should be compatible with the signaling on the far end. The trunk seizure type must be set separately for incoming (intype) and outgoing (outtype) calls. The intype and outtype settings for the trunk seizure type can be programmed as one of the following settings:

- Wink Start (factory setting)
- Delay Start (In networked Release 6.0 and later systems, use this setting for tandem tie trunks.)
- Automatic Start
- Immediate Dial

**NOTES:**

- The Immediate Dial setting should not be used for DS1 Switched 56 data calls because of the lack of trunk integrity-checking. Auto Route by Line Appearance works only with Immediate Dial and therefore cannot be used with DS1 Switched 56 data calls.
- Automatic-start trunk seizure is not available on 5ESS and DMS-100 central office switches.

Dial Mode. The dial mode must be set for incoming calls (inmode) and outgoing calls (outmode). The dial mode (inmode or outmode) can be set to either Rotary (factory setting) or Touch-Tone. Touch-tone receivers are required on the remote communications system when the setting is touch-tone. In networked Release 6.0 and later systems, use this setting for tandem tie trunks.

Dial Tone. The dial tone can be set to one of the following settings:

- **Remote** (factory setting). The system sends dial tone to callers.
- **Local.** The system does not send dial tone to callers.

Answer Supervision Timing. Answer Supervision Timing sets a limit in milliseconds that an answer supervision signal must be present to be considered valid. The timing can be set to any value in increments of 20 ms from 20 to 4,800 ms. The factory setting is 300 ms, which should be used in networked Release 6.0 and later systems for tandem tie trunks.

Disconnect Timing. Disconnect Timing sets a time limit, in milliseconds, that a disconnect signal must be present to be considered valid. The timing can be set to any value from 140 to 4,800 ms, in increments of 20 ms. The factory setting is 300 ms, which should be used in networked Release 6.0 and later systems for tandem tie trunks.

T1 Routing by Dial Plan

Beginning with Release 4.0, routing by dial plan is available on Switched 56 services offered on T1 connections.

Service providers offer digit outpulsing for their T1 Switched 56 services. With digit outpulsing, the central office sends a number of digits to the MERLIN LEGEND Communications System. When ordering the service, the system manager must choose how many digits are to be sent to the communications system. Generally, the default number of outpulsed digits is four; however the system manager may choose 3-digit outpulsing, which can be accepted by the MERLIN LEGEND Communications System for Switched 56 services.

In many cases, the digits that are sent from the service provider may not match the MERLIN LEGEND Communications System dial plan. In these cases, the digits can be manipulated by absorption, deletion, or addition of digits. The system manager also can use system programming to renumber a block of dial-plan numbers on the communications system to match the outpulsed digits.

With this enhancement, multiple telephone numbers can be used on a single T1 Switched 56 line. For example, these could be three ACCUNET Switched 56 Services channels on a T1 line/trunk with 10 different numbers on each channel. This allows 30 different (non-simultaneous) callers with unique numbers to call into the communications system and reach 30 different data extensions.



NOTE:

Most local exchange carriers (LECs) do not offer multiple telephone numbers associated with a single channel. Therefore, routing by dial plan can route calls only to a single data extension for each single telephone number provided by the local exchange carrier central office.

The three settings in the Incoming Routing Table are as follows:

- **Expected Digits.** The number of digits sent from the service provider.
- **Digit Addition.** Digits are added to the beginning of the digits.
- **Digit Deletion.** Digits are deleted from the end of the digits.

An example of an Incoming Routing Table is shown in [Table 36](#).

Table 36. Sample T1 Switched 56 Dial-Plan Routing Table

Entry	1	2	3	4...	24
Service	T1 S56	T1 S56	T1 S56		T1 S56
Expected Digits	3	3	3		3
Example #	234	235	300		492
Digit deletion	1	1	1		1
Digit addition	[none]	[none]	67		69
Extension	34	35	6700		6992

Systemwide Programming Options

Clock Synchronization

Clock synchronization is an arrangement in which digital facilities operate from a common clock. Whenever digital signals are transmitted over a communications link, the receiving end must be synchronized with the transmitting end to receive the digital signals without errors.

The system synchronizes itself by extracting the timing signal from the incoming digital stream. If the system has one 100D module, that module provides its own primary synchronization. If the system has at least one 800 NI-BRI module, more than one 100D module, or a combination of 100D modules and 800 NI-BRI modules, then one of the connections provides primary clock synchronization for all 800 NI-BRI and 100D module ports and for the system's time-division multiplexing (TDM) bus. The primary clock synchronization source must be identified during system programming. The factory setting either is the first 100D module or the first port on the first 800 NI-BRI module in the carrier. This can be changed through system programming.

In the event of a maintenance failure of primary synchronization, backup synchronization can be provided by secondary and tertiary clock synchronization.

In addition, the source of synchronization is factory-set to Loop Clock Reference Source so that the clock is synchronized to the outside source. With a 100D module, it can be set to Local Clock Reference Source so that the clock is free-running. This is not recommended, however, for most permanent installations or for systems with PRI. This setting must be made for the primary, secondary, and tertiary synchronization sources.

In Release 6.0 and later systems (Hybrid/PBX mode only) with digital tandem trunks, a single clock source should be used for all systems in the network. Generally, the rules for assigning clock sources are the same as for single systems. When the source for clock synchronization is not on a module in the local system, it is assigned as *loop*. A loop clock source may be a port connected to the PSTN or, in a network, may be the same type of port on a non-local system. When the source for clock synchronization is a local system module, it is assigned as *local*. There can be no more than one local clock source for digital tandem facilities in a network, and all other tandem facilities are assigned as *loop*. There does not have to be any local clock source in a network; all can be *loop*.

Networked systems do not always have an in-service digital PSTN facility available or active. For this reason, clock synchronization in some private networks requires choosing among other clock sources. In a network with three or more systems, it is best if all clock sources for the network are on either a hub system (star configuration) or a system that connects two other switches (series configuration). If the primary clock source is not functioning, then a secondary or tertiary source on such a system can serve either all other systems in the network or two other systems in a network. If a DEFINITY ECS or DEFINITY ProLogix Solutions system is included in the network and has functional digital PSTN facilities, it should provide the clock synchronization source. Details and examples are provided in the *Network Reference*.

The following lists the options for primary, secondary, and tertiary clock synchronization sources in order of preference:

1. The clock sources on BRI ports with Digital Subscriber Lines (DSLs) in service. If at all possible, all three clock sources should be on the same 800 NI-BRI module. If they are not, interruptions in high-speed data calls can occur when the clock source switches to a backup source.
2. The loop clock source on any 100D module.
3. The loop clock source on any 100D module in T1 mode emulating tie trunks.
4. The local clock source on any 100D module.



NOTE:

Ports that are not in service should never be programmed as clock sources.

Clock Switching

When the primary clock source is not able to provide the system clock, the secondary clock source is used, if it exists and is capable of providing the system clock. If the secondary clock source is incapable of providing the system clock, the tertiary clock source is used.

If none of these is capable of providing the system clock, the communications system searches 800 NI-BRI and 100D modules for a clock source, starting from the first module in the system and ending with the last module. The clock is chosen with the following order of preference:

1. Loop clock source on an 800 NI-BRI or 100D module.
2. Local clock source on an 800 NI-BRI or 100D module.
3. Local clock source on the processor module.

Mode Differences

Key Mode

Routing by dial plan for PRI or T1 data lines is not supported in Key mode.

Behind Switch Mode

T1 data lines are not supported in Behind Switch mode.

Considerations and Constraints

General

If a B-channel is not available when a call is placed, a fast busy tone is returned. While the tone is in progress, the line is considered busy. If the originator goes on hook while the tone continues, the call is ended and the line is idled. Otherwise, the call appearance is removed and the line is idled 15 seconds after the tone is applied.

A telephone is considered busy when: no SA button (aside from Originate Only buttons) is available, Do Not Disturb is activated, the extension either is being programmed or is in forced idle, or the alarm clock is being set. The caller hears a busy tone, and the call receives coverage, if programmed.

A PRI line can be assigned to only one B-channel group.

If the inside dial plan uses extension numbers with different numbers of digits—for example, both 3-digit extension numbers and 4-digit extension numbers—SID-ANI or other extension identification services (Release 4.2 and later systems) may not work properly.

The PRI telephone number assigned to each channel must be unique within the same B-channel group and different from the associated test number. Also, the number of each channel must be the same number as that supplied by the PRI service provider. The test telephone number assigned for each 100D (DS1)

module in the control unit must be different from the numbers assigned to other channels in the same B-channel group and must be the same number as that supplied by the PRI service provider.

An invalid timer value entered in system programming results in truncation to the closest valid value. If, for example, 45 is entered for a counter that ranges from 0 to 30 seconds, 4 is recorded.

In Release 6.0 and later, the PRI information report displays the B-channels in the order they were entered into the system, which is not necessarily numerical order.

Incoming Calls

PRI

When an incoming call is given routing-by-dial-plan treatment, the green LED associated with the appearance of the line lights steadily; the LED does not flash to indicate that the line/trunk is ringing. When an incoming call is on a personal line, the green LED associated with the line lights steadily, and ringing on an SA button occurs. The LED does not flash to indicate that the line/trunk is ringing.

Routing by dial plan requires programming of the Dial-Plan Routing Table and of the B-channel group (PRI only) or extension to be routed by dial plan.

Call Management System (CMS) does not support routing by dial plan.

Routing by dial plan information appears only on MLX display telephones.

If the number for an incoming call given routing by dial-plan treatment is not found, the call is sent to the invalid number destination for DID calls. This can be a dial-plan extension number or fast busy tone. If it is a fast busy tone, however, the call is rejected and the network applies an intercept tone.

A PRI line that has been programmed for routing by dial plan should not be programmed for remote access or Shared System Access.

Outgoing Calls

PRI

When placing a call using a PRI facility, you may want to append a # to the dialed number. This signals the facility that the number is complete and causes the call to be placed immediately.

The outgoing telephone number that matches the digit pattern in the Network Selection Table is deleted automatically. This is not programmable. The common carrier ID is sent to the foreign exchange.

In systems that are programmed using a non-uniform extension dialing plan, one base number may not be able to represent all telephones.

To specify that no telephone number is sent to the network, choose the Do Not Copy Telephone Number programming option and use the Telephone Number to Send procedure to ensure that telephone numbers are not assigned to each channel in the B-channel group. A network option to block presentation of CPN is also available.

If ARS identifies a call as applying to a call-by-call B-channel group but the Call-by-Call Services Table does not show a matching digit pattern and bearer capability, the call is rejected.

Outgoing calls using call-by-call service selection can be made by pressing a line button, pressing a Pool button, dialing a pool number, or using ARS.

The Call-by-Call Services Table must be programmed for the Call-by-Call Service Selection feature to take effect. If a service is not specified in the table, the entry is ignored.

An SMDR record is not recorded for any call on a PRI facility that is shorter than the programmed SMDR Call Length. Usually, the SMDR Call Length is programmed to compensate for connection and ringing time of calls on non-PRI facilities before they are answered. For systems where most lines are PRI lines, the call length should be programmed for one (1) second.

Feature Interactions

Account Code Entry

At an extension assigned to a PRI line, either enter an account code before the call is made or during the call. Forced account codes must be entered before the call is made. An account code entered before a call is treated as a restriction code for all the outgoing calls placed over the PRI line.

If the SMDR feature is not enabled to record incoming calls, the system does not accept Account Code Entry information for incoming calls.

Automatic Route Selection

An incoming call can access ARS only through remote access, transferring, or Remote Call Forwarding through ARS. A PRI line can be a member of a pool accessed through ARS. Before ARS routes a call to a pool, it determines whether one or more member lines in that pool are available. If not, it selects an alternative pool so that the call is not blocked. Even if a B-channel is available when ARS selects a pool with an available line, there may be none available when it is time to send a setup message to the network. Or, after the setup message is sent, the network may determine that the B-channel proposed by the system is not available. In either case, the call fails and a fast busy tone is heard.

Features

Primary Rate Interface (PRI) and T1

550

Automatic Route Selection <i>(continued)</i>	If an incoming call matches the ARS access code, it is routed to the extension programmed for unassigned DID calls.
Barge-In	Barge-In can be used on a PRI line. Users cannot barge into data calls.
Call Waiting	<p>Call Waiting is provided on PRI lines at extensions so programmed. The call-waiting tone is not blocked from PRI at an extension. Until the call is answered, answer supervision is not returned to the network and the caller hears a regular ringback instead of a call-waiting ringback.</p> <p>Call Waiting does not work with data calls.</p>
Callback	<p>Callback cannot be used to request a busy PRI line assigned as a personal line, but PRI lines in a pool are eligible for Callback. An idle PRI line is not considered an available pool member unless a check determines that it is associated with an available B-channel. Even if a B-channel is available when the pool selects a line for a callback call, there may be none available when it is time to send a setup message to the network. Or, after the setup message is sent, the network may determine that the B-channel proposed by the system is not available. In either case, the call fails and a fast busy tone is applied.</p> <p>Some applications (such as desktop video systems) that use data lines may work improperly when releasing data facilities requested by Callback.</p>
Camp-On	The system does not support Camp-On onto data calls.
Conference	The system does not support conferencing onto data calls.
Coverage	Data calls do not follow coverage delay settings. All data calls ring immediately.
Calling Restrictions	Outward and toll restrictions do not work with T1 lines emulating tie trunks when the lines are set to Tie-PBX or Tie Switched 56 Data. Use Automatic Route Selection or pool dial-out codes instead.
Forward and Follow Me	A PRI line that has been programmed for routing by dial plan cannot have Remote Call Forwarding allowed. A T1 Switched 56 line cannot be used for Remote Call Forwarding.
Group Calling	A PRI line that is a member of a B-channel group programmed for routing by dial plan should not belong to a calling group. A line that is part of a B-channel group included in a calling group should not be programmed for routing by dial plan.
HFAI	Incoming calls on a line that is a member of a B-channel group programmed for routing by dial plan are not eligible for answer by Hands-Free Answer on Intercom.
Hold	Data calls cannot be placed on hold.
Music-On-Hold	Music-On-Hold cannot be used with data calls.

Features

Primary Rate Interface (PRI) and T1

551

- Night Service** A PRI B-channel can be assigned to a Night Service group (Release 4.1 and later systems only) if its B-channel group has been programmed for routing by line appearance. If the Routing by Dial Plan option has been selected for a PRI B-channel group, its lines cannot be assigned to a Night Service group.
- Paging** If the extension for an incoming call matches a group paging extension, the call is treated as an unassigned DID call.
- Data lines cannot be used for paging.
- Personal Lines** A personal line can be assigned to an extension to represent a PRI line with routing by dial plan. When an incoming call arrives, the green LED associated with the personal line lights steadily, and ringing on an SA button occurs; the LED does not flash to indicate that a line/trunk is ringing.
- A personal line can be assigned on a voice telephone for monitoring the status of a data line; however, users *must not* use the personal line to attempt to complete a call.
- Pools** Data lines (especially T1 data) should not be put in the same pool as voice lines. System alarms eventually result if voice extensions try to access data lines.
- Queued Call Console** Data lines should not be programmed to terminate at a QCC.
- Remote Access** A PRI line that has been programmed for routing by dial plan should not be programmed for remote access.
- Ringing Options** Digital data calls do not receive distinctive ringing or Ring Timing options.
- System Access/ Intercom Buttons** T1 lines must not be shared between voice and data extensions with Shared SA buttons. The lines are programmed for either voice-only or data-only service.
- SMDR** The line/trunk number of a PRI line is shown in the LINE field of the SMDR report. The restriction code for the FTS2000 network is shown in the ACCOUNT field.
- Call timing begins when the PRI line is selected. The Called Number field shows the number dialed by the user before any digits are manipulated by ARS or PRI tables (Network Selection Table, Special Services Selection Table, or Call-by-Call Services Table). In Release 2.1 and later systems, call timing begins when the call is answered at the far end. Calls that are not answered, therefore, do not create an SMDR call record.
- If the SMDR feature is not enabled to record incoming calls, the system does not accept Account Code Entry information for these calls.

Features

Primary Rate Interface (PRI) and T1

552

Tandem Switching

In Release 6.0 and later systems (Hybrid/PBX mode only), PRI and T1 (emulated tie voice or data tie) facilities can be private tandem trunks. To provide the facility, customers order a point-to-point T1 circuit from a service provider and use system programming to set it up for PRI or T1. The provider, however, only supplies amplification, not switching services.

When system programming of the DS1 switch type labels a PRI facility as a tandem trunk, the system selects an unused B-channel group (beginning with Group 80 and counting backward) and assigns all the B-channels to it. This programming can be changed after the initial assignment.

Drop-and-insert equipment can be placed between systems connected by tandem PRI or T1 trunks to provide fractional service. All channels still count toward the 80-line system maximum, and the PRI D-channel must never be dropped.

PRI and T1 tandem trunks require the same initial DS1 programming (clock synchronization, framing format, and so on) that other such facilities do. For PRI facilities, however, routing, network service, and copy telephone number settings are programmed automatically by the system and cannot be changed unless the switch type is modified first.

When a call arrives on a dial-plan routed PRI facility and its digits match an extension on the non-local dial plan, the call is routed to the appropriate remote extension.

Transfer

For trunk-to-trunk transfer with no extension number involved, the Calling Party Number for the outbound call is the programmed base number.

Data calls cannot be transferred.

Privacy

At a Glance

Users Affected	Telephone users, DLC operators, data users
Reports Affected	Extension Directory
Modes	All
Telephones	All except QCC
Programming Code	*31
Feature Codes	
On	31
Off	*31
MLX Display Label	Privacy [Prvcy]

Description

Privacy prevents other people from joining calls on shared personal lines or Shared SA buttons. Privacy also prevents Barge-In from being used to join a call.

An extension user can turn on Privacy before or during a call, and it remains on for all calls to and from that extension until the user turns it off.

When Privacy is turned on at an extension, anyone selecting a shared personal line or Shared SA button on which a call is active hears silence, instead of joining the call. A person using Barge-In hears a busy signal when trying to join a call on a telephone with Privacy turned on.

If Privacy is turned on while a call is in progress, it does not affect anyone who has already joined the call but prevents other users from joining the call.

Privacy is automatically turned on for data calls at digital data workstations and analog voice and modem data workstations connected to analog multiline telephones. Privacy must be turned on manually at modem data-only workstations and MLX voice and modem workstations connected to a Multi-Function Module.

Considerations and Constraints

If a multiline telephone user intends to use Privacy, he or she should program a button for it, so that the green LED next to the button gives a visual reminder when Privacy is turned on.

Single-line telephone users receive no indication of whether Privacy is on or off.

Privacy is automatically on at data workstations, except for modem data-only workstations and for MLX voice and modem data stations, where Privacy can be activated as part of the dialing sequence.

Telephone Differences

Queued Call Consoles

A QCC operator cannot use Privacy.

Other Multiline Telephones

To turn on Privacy, either press the programmed Privacy button—the green LED turns on—or press the Feature button and dial 31.

To turn off Privacy, either press the programmed Privacy button—the green LED turns off—or press the Feature button and dial *31.

When an MLX display telephone user turns on Privacy, the display briefly shows the message *Privacy On* before returning to the Home screen or call-handling display. When the user turns off Privacy, the display briefly shows the message *Privacy Off*.

When an MLX-5 or MLX-10 nondisplay, ETR, MLS, or analog multiline telephone user (with or without a display) turns Privacy on or off, there is no visual confirmation unless a Privacy button is programmed on the telephone. If a Privacy button is programmed, its green LED turns on and off with the Privacy feature.

Single-Line Telephones

To turn on Privacy before making or receiving a call, lift the handset and, while listening to the inside dial tone, dial #31; then hang up. To turn on Privacy while a call is in progress, press and release either the Recall or Flash button or the switchhook and dial #31. To return to the call, press and release either the Recall or Flash button or the switchhook again.

To turn off Privacy before making or receiving a call, lift the handset and (while listening to inside dial tone) dial #*31; then hang up. To turn off Privacy while a call is in progress, press and release either the Recall or Flash button or the switchhook and dial #*31. To return to the call, press and release either the Recall or Flash button or the switchhook again.

A single-line telephone user has no indication of whether Privacy is on or off.



NOTE:

Some single-line telephones, such as Lucent Technologies models 2500YMGL and 2500MMGK, use a positive or timed disconnect. On these telephones, pressing the switchhook disconnects the call. You must use the Recall or Flash button instead of the switchhook when turning Privacy on or off.

Feature Interactions

Barge-In	Barge-In does not override Privacy.
Digital Data Calls	Privacy is turned on automatically during digital data calls.
Display	When an MLX display telephone user turns on Privacy, the display briefly shows the message <code>Privacy On</code> before returning to the Home screen or call-handling display. When the user turns off Privacy, the display briefly shows the message <code>Privacy Off</code> .
Headset Options	Privacy should be turned on when headset users with Headset Auto Answer turned on either have Shared SA buttons or share one or more personal lines. Privacy keeps the users from competing for the same call. When two or more users try to answer the same call on an SSA or personal line button, the red and green LEDs next to the button go on, but only one person can talk with the caller.
Hold	Privacy protects a call only while the user is active on the call. Privacy does not keep a user at another extension from picking up a call while it is on hold.
HotLine	Privacy is not available for HotLine extensions (Release 5.0 and later systems).
Multi-Function Module	Privacy should not be used on an MFM (unless Privacy is to stay on at all times, as at a data workstation) because the user does not have an LED to indicate whether Privacy is on or off.
Personal Lines	If Privacy is turned on at an extension, a user with a shared personal line button for that extension cannot join a call on that button. If Privacy is turned on while a call is in progress, it does not affect anyone who has already joined the call but prevents other users from joining the call.
Recall/Timed Flash	A single-line telephone user with a Recall or Flash button can use Recall or Flash to turn Privacy on or off during a call. The user must press Recall or Flash and #31 to turn Privacy on, or *#31 to turn Privacy off.
Service Observing	In Release 6.1 and later systems, Service Observers can observe calls even if the observed extension is using the Privacy feature.

Features
Privacy

556

Signal/Notify

Users can program and use a Signaling button to contact a co-worker who has turned on Privacy.

**System Access/
Intercom Buttons**

If Privacy is turned on at an extension with a Shared SA button, other users, including the principal extension, cannot join a call on that button.

If Privacy is turned on while a call is in progress, it does not affect anyone who has already joined the call, but prevents other users from joining the call.

Programming

At a Glance

Users Affected	System managers
Modes	All
Telephones	All



SECURITY ALERT:

Remote System Programming. *As a customer of a new communications system, you should be aware that telephone toll fraud is an increasing problem. Telephone toll fraud can occur in many forms, despite the numerous efforts of telephone companies and telephone equipment manufacturers to control it. Some individuals use electronic devices to prevent or falsify records of these calls. Others charge calls to someone else's number by illegally using lost or stolen calling cards, billing innocent parties, clipping on to someone else's line, and breaking into someone else's telephone equipment physically or electronically. In certain instances, unauthorized individuals make connections to the telephone network through the use of remote access features.*

The Remote Access feature of your system, if you choose to use it, permits off-premises callers to access the system from a remote location by using an 800 number or a 7- or 10-digit telephone number. The system returns an acknowledgment signaling the user to key in his or her barrier code, which is selected and programmed by the system manager. After the barrier code is accepted, the system returns dial tone to the user. If you do not program specific egress restrictions, the user can place any call normally dialed from an extension associated with the system. Such an off-premises network call is originated at, and will be billed from, the system location.

The Remote Access feature, as designed, helps the customer, through proper programming, to minimize the ability of unauthorized persons to gain access to the network. Most commonly, telephone numbers and codes are compromised when overheard in a public location, through theft of a wallet or purse containing access information, or through carelessness (writing codes on a piece of paper and improperly discarding it). Additionally, hackers may use a computer to dial an access code and then publish the information to other hackers. Enormous charges can be run up quickly. It is the customer's responsibility to take the appropriate steps to properly implement the features, evaluate and program the various restriction levels, protect access codes, and distribute access codes only to individuals who have been fully advised of the sensitive nature of the access information.

Common carriers are required by law to collect their tarified charges. While these charges are fraudulent charges made by persons with criminal intent, applicable tariffs state that the customer of record is responsible for payment of all long-distance or other network charges. Lucent Technologies cannot be responsible for such charges and will not make any allowance or give any credit for charges that result from unauthorized access.

To minimize the risk of unauthorized access to your communications system:

- *Use an unpublished remote access number.*
- *Assign barrier codes randomly to users on a need-to-have basis, keeping a log of ALL authorized users and assigning one code to one person.*
- *Use random-sequence barrier codes, which are less likely to be easily broken.*
- *Deactivate all unassigned codes promptly.*
- *Ensure that remote access users are aware of their responsibility to keep the telephone number and any barrier codes secure.*
- *When possible, restrict the off-network capability of off-premises callers through use of calling restrictions and Disallowed List capabilities.*
- *When possible, block out-of-hours calling.*
- *Frequently monitor system call detail reports for quicker detection of any unauthorized or abnormal calling patterns.*
- *Limit Remote Call Forwarding to persons on a need-to-have basis.*

Description

The system provides three types of programming:

- System programming
- Centralized telephone programming
- Extension programming

The tables in Appendix C provide complete lists of system operator and extension features, their programming codes, and the telephones on which the features can be programmed. The tables also show which features can be assigned only through centralized telephone programming.

System Programming

Initial system programming is performed when the system is planned and installed. The system can be reprogrammed as needs change.

Like centralized telephone programming, you can program the system either from the system programming console or by using SPM software.

Brief descriptions of the pertinent programming paths can be found in the “At a Glance” section.

Complete information about system programming can be found in *System Programming*.

A chart showing the system programming hierarchy is in Appendix E.

Programming at an MLX-20L Telephone

The MLX-20L telephone is the only telephone that can be used as a system programming console (see [Figure 28](#)). For initial programming of a new system, the MLX-20L telephone must be connected to the first extension jack on the first MLX module.

For subsequent programming, the jack assignment can be changed. The system operator jack can be used, or a separate system programming jack can be designated to allow programming of the system without interfering with system operator call handling.

The buttons next to the console’s display are used to do most of the programming. The top two buttons on each side are labeled and have the same functions in every screen. They are Home, Menu, More, and Inspct. The next five unlabeled buttons on each side are used to select options from a menu displayed on the screen.

The red and green LEDs next to the 20 line and feature buttons assist the system programmer. These buttons are on or off during programming, depending on whether or not they have already been programmed.

Programming the system may also involve using the dialpad, some of the labeled function buttons on the lower portion of the console, or the 20 line and feature buttons in the center of the console. The overlay that “renames” buttons for use during programming is shown in [Figure 29](#). The overlay shows both pages of the numbers of line buttons when the telephone is in centralized telephone programming mode. It also shows the letters to which buttons correspond for programming Directories.

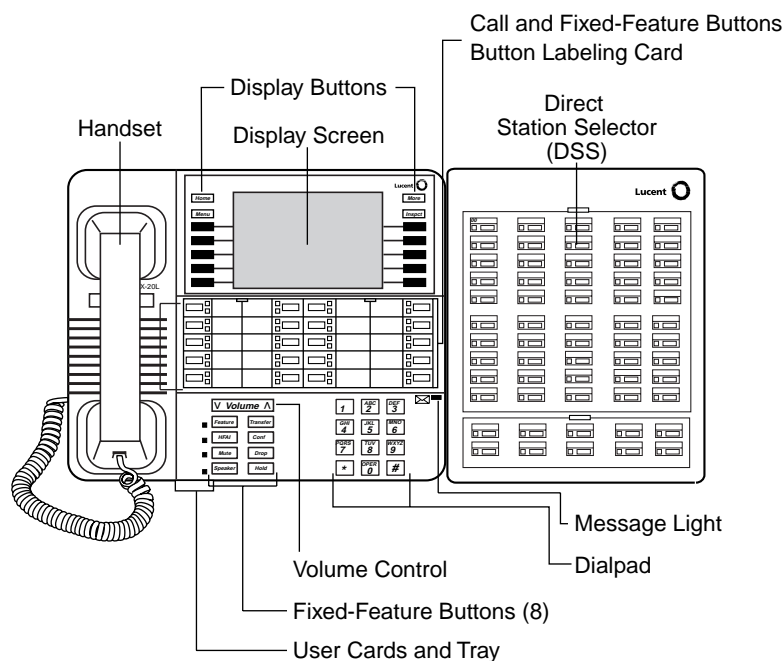

Figure 28. MLX-20L Telephone and DSS

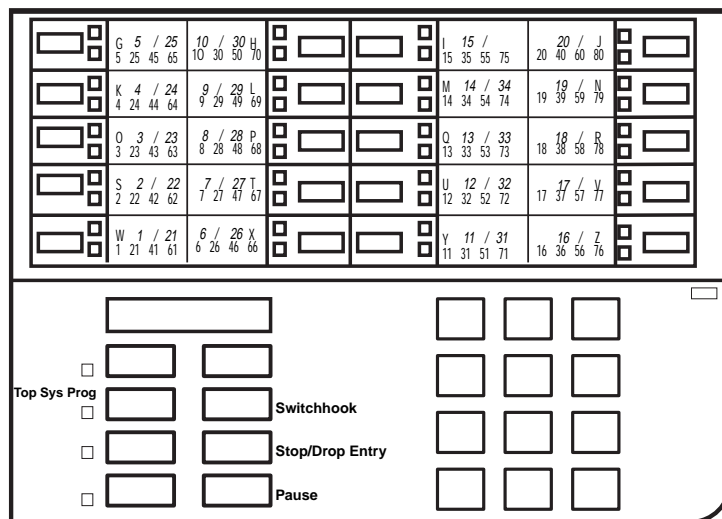

Figure 29. System Programming Console Overlay

Direct Station Selector

One or two DSSs can be used with the MLX-20L telephone. Each DSS adds 50 buttons to the system programming console. For more information about the DSS, see [“Direct Station Selector” on page 240](#).

The LEDs on the DSS indicate the status of telephone features during system programming, such as calling restrictions. Each LED on the DSS represents an extension connected to the system. When certain features are selected from the System Programming menu, the LEDs on the DSS indicate the status of the feature for each extension. For example, if *Restriction* is selected from the Extension menu, the red LED is on for each extension that is toll-restricted.

Programming with SPM on a PC

The advantages of programming the system with a PC are the availability of surrogate mode and, in releases prior to Release 3.0 (where programming can be backed up on a PCMCIA memory card), the security that comes from knowing that programming can be backed up on a floppy or hard disk. This makes recovery of system programming fast and efficient in the event of an inadvertent system shutdown or loss of power.

To program with a PC, SPM software is needed, along with the appropriate Windows, DOS, or UNIX operating system software; the last is necessary only if you are using Integrated Solution II/III.

For Release 6.0 and later systems, SPM is available in a Windows format called WinSPM. WinSPM provides a graphical user interface (GUI) for those tasks commonly performed by the system manager. Included in WinSPM are pictorial representations of system components (such as modules and their vintages). WinSPM also provides an SPM DOS Emulator mode that allows basic SPM programming of all releases of the MERLIN LEGEND System. Also supported in Release 6.1 and later systems is SPM programming for options not included in the GUI. WinSPM is supported in Windows 95, Windows NT, and Windows 98.

The rest of this section describes the DOS or DOS-emulation version of SPM. If you are using WinSPM, refer to the documentation and the on-line help that are part of the WinSPM package.

Release 4.1 and later systems work with a version of SPM that allows you to program in a DOS window of Windows 95. SPM provides an interface to the programming and maintenance software in the control unit processor module. The SPM software emulates the display screen and buttons of a system programming console (the MLX-20L telephone). As shown in [Figure 30](#), the SPM display mirrors the following three areas of the console:

- Display and display buttons (at the top of the SPM screen).
- Function buttons (described on the right side of the screen).

- Line buttons (represented in the lower portion of the display).

To use SPM for system programming, you must connect the PC to the control unit. This can be done either directly through the system programming jack on the control unit or through a modem (modems can be used for either on-site or remote programming). See *System Programming* for details on SPM use.



NOTE:

Beginning with Release 3.0, SPM is no longer necessary in order to back up system programming. System programming can be backed up on a memory card. For details, see *System Programming*.

U7		QUIT MENU		Home End		Welcome to SPM The MERLIN LEGEND System Programming & Maintenance Utility Please press any key to continue. Version 7.15				PgUp PgDn		MORE INSP		Drop ALT-P			
		F1		F2		F3		F4		F5		F6		F7		Flash ALT-F	
		F8		F9		F10										TopSP ALT-C	
Shift F5		LINE 05		LINE 10		Shift F10		Alt F5		LINE 15		LINE 20		Alt F10		Pause ALT-H	
Shift F4		LINE 04		LINE 09		Shift F9		Alt F4		LINE 14		LINE 19		Alt F9		CONVERT ALT-U	
Shift F3		LINE 03		LINE 08		Shift F8		Alt F3		LINE 13		LINE 18		Alt F8		HELP CTL-F1	
Shift F2		LINE 02		LINE 07		Shift F7		Alt F2		LINE 12		LINE 17		Alt F7		RESET CTL-F5	
Shift F1		LINE 01		LINE 06		Shift F6		Alt F1		LINE 11		LINE 16		Alt F6		BROWSE CTL-F8	

Figure 30. SPM Display

Onsite and Remote Programming

PC-based SPM programming through a modem is performed either onsite or from a remote location. In both cases, the modem built into the control unit is used. Dialing *10 connects to the control unit modem's extension jack.

The built-in modem for remote programming can be reached in any of the following ways:

- Call the system on a remote-access line and enter a barrier code (if needed), and then dial the code for the control unit's built-in modem (*10).
- Call the system on a regular line and ask the system operator to transfer the call to the control unit's built-in modem (*10).

- Call the remote PC with SPM from a telephone on the system, then transfer the call to the control unit's built-in modem (*10)

Remote programming allows technicians to run diagnostic tests and to display information needed to maintain the system. It is also used by Lucent Technologies technical support organizations for installation and maintenance support.

Remote system programming overrides onsite system programming unless an onsite backup or restore procedure is taking place. If onsite system programming is being performed when a remote connection is attempted, the system sends a message to the programmer that a remote connection has been established and the current onsite programming session is terminated.

If remote system programming is to be done over loop-start lines, the lines should be set to reliable disconnect. Otherwise, a line could be seized indefinitely.

System Programming Screens

The system programming console display and SPM screen present step-by-step prompts throughout programming. Three different types of screens appear on the console display and SPM screen:

- **Menu Selection Screens.** Allow selection of menu options. After making a selection, either a more detailed menu screen or a data entry screen is shown.
- **Informational Screens.** Show currently programmed information. Changes cannot be made to these screens.
- **Data Entry Screens.** Allow identification information (such as an extension number or line/trunk number) or values (such as number of seconds or rings) to be entered.

The menu hierarchy—the sequence of menu screens that appears as different options are selected from menus during system programming—is shown in [Appendix E, “System Programming Menu Hierarchy.”](#)

System Programming Reports

System programming reports are available when `Print Opts` is selected from the System Programming menu. These reports can be directed to the SMDR printer or a printer connected to the PC used for system programming. In addition, `Print Opts` allows you to direct reports to the PC, so you can use the Browse option to read reports on the PC screen. See [Appendix F, “Sample Reports.”](#)

Centralized Telephone Programming

Centralized telephone programming allows the system manager to program, from a single location, any feature that can be programmed by individual extension users or system operators. Centralized telephone programming can be done on the programming console (MLX-20L) or on a PC with SPM software.

The following features can be programmed only through centralized telephone programming (not by individual users):

- Barge-In
- Headset Hang Up
- All SA buttons (Hybrid/PBX mode) and ICOM buttons (Key and Behind Switch modes)
- Service Observing button

Extension Programming

Extension Programming allows extension users and system operators to customize their extensions to meet personal needs. Multiline telephone users can assign a wide range of features to buttons on the telephone. Many other settings (Call Waiting, for example) that do not require button assignment can be programmed on both multiline telephones and single-line telephones.

Users can program their extensions by dialing programming codes or, on MLX display telephones, by selecting features from the display. When an extension user programs his or her extension, the system considers the extension busy; therefore, no incoming calls arrive at the extension until programming is completed. See [Appendix D, "General Feature Use and Telephone Programming"](#) for instructions on how to program features on MLX, ETR, MLS, analog multiline, and single-line telephones.



NOTE:

Before you begin to program a feature onto a button that already has a feature assigned to it, make sure that any light associated with the button is off. In some cases, if the light is on, the feature remains active, even though a new feature has been programmed onto the button. If this happens, you can turn off the original feature only by programming a new button with that feature and deactivating the feature with that button. You can then delete the new feature.

Queued Call Console (QCC)

At a Glance

Users Affected	QCC operators
Reports Affected	Operator Information, System information (SysSet-up)
Mode	Hybrid/PBX
Telephones	MLX-20L telephones
System Programming	<p>Assign or remove a QCC position:</p> <ul style="list-style-type: none"> ■ Operator→Positions→Queued Call→Store All <p>Change operator hold timer for all QCC (and DLC) operators:</p> <ul style="list-style-type: none"> ■ Operator→Hold Timer <p>Assign QCC queue priority to individual lines/trunks:</p> <ul style="list-style-type: none"> ■ LinesTrunks→More→QCC Prior <p>Assign QCC operator to receive calls on individual lines/trunks:</p> <ul style="list-style-type: none"> ■ LinesTrunks→More→QCC Oper <p>Specify treatment for calls on DID trunks to invalid (unassigned) extensions:</p> <ul style="list-style-type: none"> ■ LinesTrunks→DID→InvalidDstn <p>Specify destination for calls on DID trunks to invalid extensions, if sent to backup extension:</p> <ul style="list-style-type: none"> ■ Options→More→Unassigned <p>Assign call types to ring in to QCC queue, QCC operator to receive calls, and priority level:</p> <ul style="list-style-type: none"> ■ Operator→Queued Call→Call Types <p>Specify frequency for elevate priority (queue reprioritization):</p> <ul style="list-style-type: none"> ■ Operator→Queued Call→ElevatePrior <p>Specify whether calls on hold return to QCC queue after operator hold timer has expired twice:</p> <ul style="list-style-type: none"> ■ Operator→Queued Call→Hold Rtrn <p>Select automatic Hold or automatic Release for all QCC operators:</p> <ul style="list-style-type: none"> ■ Operator→Queued Call→HoldRelease <p>Enable or disable calls-in-queue alert:</p> <ul style="list-style-type: none"> ■ Operator→Queued Call→InQue Alert <p>Specify threshold for queue-over-threshold alert:</p> <ul style="list-style-type: none"> ■ Operator→Queued Call→Threshold

Features

Queued Call Console (QCC)

566

Select automatic or manual extended call completion for all QCC operators:

- Operator→Queued Call→ExtndComplt

Designate calling group as QCC position-busy backup:

- Operator→Queued Call→More→QCC Backup

Specify return ring interval for extended calls:

- Operator→Queued Call→Return Ring

Assign QCC positions for message center operation:

- Operator→Queued Call→Msg Center

Enable or disable Voice Announce capability for QCCs (Release 4.0 and later):

- Operator→Queued Call→More→Voice Annc

Change Overflow Coverage Number:

- Extensions→More→Grp Calling→Overflow

Change LDN extension:

- SysRenumber→Single→More→ListDirectNo

Hardware

008 MLX or 408 GS/LS-MLX module

Maximums

QCC Positions	4 (8 operators total, including DLCs)
QCCs for Each Module	2
Position-Busy Backups	1

Factory Settings

Operator Hold Timer	60 sec (range 10–255 sec)
QCC Queue Priority for Trunks/Call Types	4 (range 1–7)
Treatment of Calls to Invalid Extensions	Backup Extension
Destination for Calls to Invalid Extensions	QCC Queue
Call Types	
Dial 0	Primary system operator
Unassigned DID	Primary system operator
Listed Directory Number	Primary system operator
Returning Calls	Originating operator position (Initiator)
Group Coverage	None

Features

Queued Call Console (QCC)

567

Elevate Priority	0 (no reprioritization) (range 5–30 sec, 0)
QCC Hold Return	Remain on Hold
QCC Hold Release	Automatic Release
Calls-in-Queue Alert	Disabled
Queue Over Threshold	0 (no alert) (range 1–99 calls, 0)
Extended Call Completion	Automatic None
Position Busy Backup	Disabled
QCC Voice Announce	4 rings (range 1–15 rings)
Return Ring Interval	None
Message center position	800
Listed Directory Number	

Description

The QCC is an answering position available only in Hybrid/PBX mode. The QCC is an MLX-20L telephone used by operators to do the following:

- Answer outside calls that are directed either to the QCC queue or to a specific QCC operator.
- Answer inside calls either to the operator or to a specific QCC operator's extension.
- Direct (*extend*) inside and outside calls either to an extension or to an outside telephone number.
- Serve as a message center.
- Make outside calls, for example, for users with extensions restricted from making outside calls.
- Set up conference calls.
- Monitor system operation.

The system can have up to four QCCs. Two QCCs can be designated for each 008 MLX or 408 GS/LS-MLX module, with QCCs assigned only to the first and fifth extension jacks on each module. The first QCC must be assigned to the first extension jack in the system—that is, to Port 1 of the MLX module installed in the lowest-numbered slot.

The first jack on the first MLX module is factory-set as the *primary system operator position*. This cannot be changed. The primary system operator is designated to receive Dial 0, Unassigned DID, and LDN calls. If a system has both DLC and QCC operator positions, the factory-set primary operator position must be a QCC.

QCC Operation

Call Delivery

Outside calls designated through system programming to ring at a QCC are sent by the system to a single common QCC *queue*, where they wait to be sent to a QCC operator console. When a QCC operator is available to receive a call, the system removes the call from the queue and sends it to an idle Call button on the QCC. Call buttons are used on QCCs to answer incoming calls and to make inside and outside calls.

Calls are delivered to a QCC operator in first-in first-out order, according to the *queue priority level* assigned to each type of call. If more than one QCC operator is available, the operator who has been idle the longest receives the call.

Both inside and outside calls ring on Call buttons on the QCC. Unlike the Direct-Line Console (DLC), on which multiple incoming calls can ring simultaneously, the QCC receives one call at a time, regardless of the number of calls in the QCC queue. When a call rings on a Call button, call origin information is shown on the display.

In Release 4.0 and later releases, when Voice Announce for QCCs is enabled, the fifth Call button can be used to announce a call on another user's speakerphone (providing there is an available SA button capable of receiving pages at the receiving telephone). If Voice Announce is disabled (factory setting), then the fifth Call button functions just as any other Call button does. Inspecting this button displays *Call 5 Voice* if Voice Announce for QCCs is enabled and *Call 5 Ring* if Voice Announce for QCCs is *not* enabled.

Operator Availability

A QCC operator is available to receive a call from the queue when there are no active calls (including ringing calls) at the console except calls on hold. A QCC operator is unavailable to receive a call from the queue under the following conditions:

- A call is ringing at the console.
- The operator is on a call.
- The operator has a call in the *split condition* (see below).
- The operator is setting up a conference.
- All Call buttons are busy.
- The console is being used for system programming.
- The console is in maintenance mode.

- The operator is programming a Personal Directory listing or the Alarm Clock.
- The console is not plugged in.

Extending Calls

To direct an active call to another extension or to an outside number by using a QCC, press either the Start button or a DSS button. The Start button *splits* the call, or divides it into two separate halves, each connected to the QCC.

The active call, or *source*, automatically goes on hold at the Source button, and the green LED next to the Source button flashes. An outside caller hears either Music-On-Hold, if programmed, or nothing. An inside caller hears nothing.

A QCC operator hears a dial tone on the same Call button where the call had been active. The operator can use the dialpad, a Directory feature, or a DSS button to dial either another extension, an outside number, or a non-local extension (Release 6.1 and later systems). This second half of the call is the *destination*.

The QCC display shows that the call is split. Once the destination has answered, the operator can press the appropriate button (Source or Destination) to speak with the party on either half of the split call. The operator can go back and forth between the source and destination as many times as necessary. An operator connects the two halves of the split call by pressing one of the following buttons:

- **Join** connects all three parties—source, destination, and operator—in a three-way conference on the original Call button.
- **Release** connects the source and destination and removes the call from the queue. The operator is now available to receive another call from the queue. Only one split call can be active at any given time on a QCC.

A DSS button does one of two things, depending on how extended call completion is programmed for the system:

- With *manual completion*, the call is split automatically. When an operator presses a DSS button, the active call (the source) goes on hold at the Source button and the extension represented by the DSS button (the destination) is dialed. Once the destination user answers, the operator can either press the Source or Destination button to talk to one party at a time, automatically putting the other on hold, or press the Release or Join button to connect the parties to each other.
- With *automatic completion*, the extension is dialed automatically and the call is released from the console. The effect is the same as if the operator had split the call, dialed an extension, and then pressed Release to join the source and destination and remove the call from the console.



NOTE:

When the system is programmed for automatic completion, an operator can still split and complete the call manually by first pressing the Start button, then using the dialpad or a Directory feature to dial the destination, and pressing the Release or Join button. In this situation, the operator cannot use a DSS button to dial because automatic completion would take over and release the console.

QCC Features

The MLX-20L telephone is the only telephone that can be assigned as a QCC. A QCC operator cannot use feature codes to activate features. Only the features that can be selected from the display or assigned permanently as buttons on the console can be used. To simplify call handling, the Home screen includes features used often by a QCC operator. The features available on the Home screen depend on the status of the call in progress, as shown in [Table 37](#).

Table 37. Features Available at Call Progress Stages

Call Progress	Feature Displayed	Display Appearance
Inactive or inside dial tone	Group Pickup	Pickup Grp
	Pickup	Pickup
	Loudspeaker Page	Loudspkr Pg
	Account Code Entry	AccountCode
	Follow Me	Follow Me
Reached busy extension	Cancel Follow Me	CancelFollow
	Barge-In	Barge In
	Leave Message	Leave Msg
Ringing at, or connected to, extension	Camp-On	Camp On
	Barge-In	Barge In
	Leave Message	Leave Msg
Connected to an outside line	Camp-On	Camp On
	Account Code	AccountCode
	Follow Me	Follow Me
	Cancel Follow Me	CancelFollow

The 7-line, 24-character display also provides a QCC operator with descriptive information about incoming and outgoing calls. This information includes the extension numbers and any programmed labels (such as names), the line/trunk identifiers, the reasons for call return and redirection, and the number of unanswered calls waiting in the queue. See [“Display” on page 271](#) for details on call information displays.

The QCC is automatically assigned the buttons shown in [Figure 31 on page 571](#). These assignments cannot be changed or reprogrammed. Each of these buttons is described following [Figure 31](#).

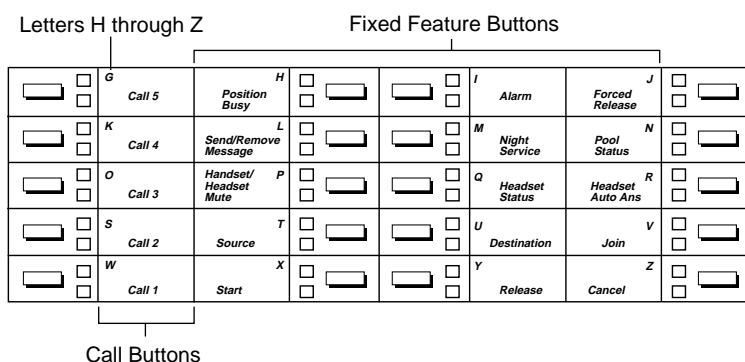

Figure 31. QCC Button Assignments

Table 38. QCC Buttons

Button	Description
Call	Five Call buttons are used for answering incoming calls and making inside and outside calls. Call buttons are set for Immediate Ring. The fifth Call button on a QCC can be programmed to send Voice Announce calls to other extensions if Voice Announce for QCCs is turned on. The receiver must be able to handle Voice Announce calls; otherwise the call rings at the receiving extension.
Start	Initiates call direction by putting a caller on hold at the Source button and providing inside dial tone to the QCC operator.
Source	Reconnects the QCC operator to the source and puts the destination on hold while the call is split.
Destination	Reconnects the QCC operator to the destination and puts the source on hold while the call is split.

Table 38. QCC Buttons — Continued

Button	Description
Release	Releases the QCC operator from a call and/or completes call direction, making the operator available for another call.
Cancel	Cancels call direction and reconnects the QCC operator with the caller (source). If the QCC operator is already connected to the source (destination is on hold), pressing this button has no effect.
Join	Connects all three parties—source, destination, and QCC operator—in a three-way conference on one Call button.
Handset/ Headset Mute	Turns the handset or headset microphone off or on. When the microphone is off, the QCC operator can speak with another person without being heard by the caller. The red LED next to the button is on when the headset or handset microphone is off, and off when the headset or handset microphone is on.
Headset Status	Turns console headset operation on and off. When headset operation is on, the green LED next to the button is on; the QCC operator must use a headset or the speakerphone. When headset operation is off, the green LED is off; the QCC operator must use the handset or the speakerphone.
Headset Auto Ans	<p>Turns the Headset Auto Answer feature on and off when headset operation is activated. The green LED next to the Headset Auto Answer button is on when the feature is on and off when the feature is off. When the feature is on and a call arrives at the QCC, the operator is connected to the call automatically. To protect the privacy of any conversation an operator may be having, the operator hears a tone in the headset and the microphone is turned off briefly before the call is connected.</p> <p>The feature can be turned on during a call without disconnecting the caller and is effective immediately.</p>
Send/ Remove Message	Turns the Message LED on a telephone on or off. For telephones without a display, this button is the only way the message LED can be turned on, unless the telephone is programmed as a message-waiting receiver for a fax machine or calling group or the system has a voice messaging system connected.

Table 38. QCC Buttons — Continued

Button	Description
<p>Position Busy</p>	<p>Temporarily takes the QCC out of service. When the console is in the position-busy state, the green LED next to the button is on and the position does not receive calls from the QCC queue. However, the position does receive calls to the QCC operator's extension and Forward and Follow Me calls directed to that extension.</p> <p>When a QCC operator puts the console in the position-busy state, incoming calls and any calls already in the queue are directed to other available QCCs (whether or not they normally receive such calls). When all QCC operators are in the position-busy state, calls are directed to a calling group assigned as the position-busy backup.</p> <p>A QCC operator can still make calls when the console is in the position-busy state.</p>
<p>Night Service</p>	<p>Turns Night Service on and off.</p>
<p>Alarm</p>	<p>Provides visible indication of a system alarm. When there is a system alarm, the red LED next to the button is on and the QCC operator can use Inspect to determine the number of alarms present.</p>
<p>Pool Status</p>	<p>Provides a QCC operator with information about the status of all pools. The QCC operator presses the Inspct button, then the Pool Status button, and the busy or available status of pools is displayed. The information includes the number of trunks and the number of busy lines/trunks in each pool.</p>

Each QCC can have one or two DSSs attached. A QCC operator can use the buttons during call handling, for example, to direct a call, make an inside call, park a call, or see the availability of an extension. See [“Direct Station Selector” on page 240](#) for detailed information about the use of the DSS.

QCC Options

The options described in this section are assigned through system programming and are available only for QCCs.

Trunk Routing

The factory setting does not assign lines/trunks to specific QCCs. Calls received on each line/trunk can be programmed to ring on one or more individual QCCs.

When a QCC receiving calls is in the position-busy state, any incoming calls (except for forwarded calls and calls directed to that console's extension) are directed to other available QCCs that are programmed to receive calls on the line/trunk. If no QCC position is programmed to receive the call, the call is directed to any available QCC whether or not it normally receives such calls. When all QCC operators are in the position-busy state, calls received on lines (including calls currently waiting in the queue) are sent to the programmed backup calling group.

In addition to specifying the lines that ring on each QCC, you can specify a priority for each line/trunk. See [“QCC Queue Priority” on page 576](#).

Personal line and Pool buttons cannot be assigned to a QCC.

DID trunks, dial-in tie trunks, tandem trunks (Release 6.0 or later systems only), or dedicated remote access lines/trunks cannot be programmed to ring into the QCC queue, although calls on these lines/trunks can be assigned to ring at a QCC operator's extension, as described later in this section.

Lines/trunks assigned to ring into the QCC queue also can be assigned as personal lines on one or more telephones.

Call Types

The Call Types option specifies other types of calls that ring into the QCC queue. The following types of calls may be directed to a specific QCC position with a specified queue priority level:

- Dial 0 calls (calls to the QCC operator).
- Calls to unassigned (invalid) extensions, either received on DID or dial-in tie trunks or dialed by remote access users.
- Calls to unassigned extensions can be programmed either to receive a fast busy signal or to be directed to a backup position. The backup position can be any individual extension (including one that is not an operator position), the QCC queue, or a calling group.



NOTE:

Assigning a QCC operator to receive the calls does not cause the calls to ring into the queue. The calls must be programmed to go to a backup position, and the QCC queue must be programmed as the backup position.

- Calls to the LDN (the extension for the QCC queue).
- Returning calls (unanswered directed, camped-on, held, and QCC operator-parked calls).
- Group Coverage calls (the QCC can be designated to receive Group Coverage calls).

The following types of calls are assigned only a queue priority level. They cannot be directed to an individual QCC because they are always made to a specific operator position by the caller:

- Calls signed in (Follow Me) or forwarded to a QCC operator.
- Calls to a QCC operator extension (for example, calls received from an inside or remote access user).
- Calls received on DID or dial-in trunks programmed to reach a QCC operator's extension rather than the QCC queue.

The factory setting directs the following call types to the primary QCC operator position:

- Dial 0 calls.
- Calls to the LDN.
- Calls to invalid destinations (unassigned extensions, for example).

Group Coverage calls are not programmed to ring at any specific QCC.

For returning calls, the factory setting returns calls to the originating operator position (the initiator).

The factory settings can be changed so that each type of call is either directed to a different and/or additional QCC or is not directed to any of the QCC operator positions. In addition, if the QCC queue is assigned to be a Group Coverage receiver, and if no QCC operator is assigned to receive calls for the coverage group, the coverage calls go to the primary QCC operator position.

If the caller dials 0 or the LDN, the caller hears a fast busy tone if the call is:

- On a DID trunk.
- On a tandem trunk (Release 6.0 or later systems only).
- On a dial-in tie trunk.
- Dialed by a remote access user and not programmed to ring at a QCC extension.

On other types of lines, the caller hears an error tone.

If returning calls are not directed to a QCC operator position, the caller hears normal ringback, Music-On-Hold, or silence, and is not made aware by any special audible feedback that the call is not returning to the queue for further handling.

Programming an operator to receive DID calls to invalid destinations (unassigned extension numbers) does not cause the calls to ring into the QCC queue, unless the QCC queue is also programmed as the backup extension.

QCC Queue Priority

The QCC queue priority determines the priority of calls programmed to ring into the QCC queue. A priority value from 1 up to 7 is assigned; this value determines the order in which calls are sent to QCCs. A value of 1 is the highest priority and 7 is the lowest. The factory-set priority level is 4 for all call types and lines/trunks.

The values can be changed for each line/trunk and each call type, according to the order in which calls should be answered. Call types are as follows:

- Dial 0
- Forward/Follow Me
- Unassigned DID
- LDN
- Returning
- Group Coverage
- QCC extension

For example, if important customer calls are received on particular lines/trunks, a priority value of 1 should be programmed so that the calls are answered before any others. Values of 2 through 7 should be assigned to lines or call types used for less important calls. Careful planning of QCC queue priority assures prompt answering of all important business calls.

Elevate Priority

During high-volume calling periods, only high-priority calls may be delivered to a QCC within a reasonable amount of time. Low-priority calls can remain unanswered if there is a constant flow of higher-priority calls.

Elevate Priority helps avoid this problem by allowing the system to raise the priority of a call that has been waiting too long in the QCC queue. The setting determines the length of time (5–30 seconds) before calls waiting in the QCC queue are automatically reprioritized to a higher level. The factory setting is 0, which means that calls are not reprioritized.

When the QCC queue is reprioritized, the priority of every call in the queue is increased to the next higher level. For example, a call that is currently at a priority level of 4 is changed to the next higher priority level of 3 when the timer expires. However, the priority of a call is never elevated to 1 because calls assigned to that level must reach a QCC operator as quickly as possible.

Extended Call Completion

The setting for the Extended Call Completion option determines whether or not the process of directing calls (also known as *extending* calls) is completed automatically when a QCC operator with a DSS presses a DSS button. The following are the available settings for extended call completion:

- **Automatic** (factory setting). A QCC operator can answer a call and direct it by pressing the DSS button. The operator does not need to press either the Start button to begin directing the call or the Release button to complete the process. If a QCC operator chooses, he or she can press the Start button before pressing the DSS button. However, call directing is automatically completed when the QCC operator presses a DSS button.

With the Automatic option set for extended call completion, a QCC operator can announce transferred calls only by pressing the Start button and then manually dialing the destination extension number.

- **Manual**. A QCC operator can initiate the call direction and dial the extension by pressing a DSS button while on a call. However, the QCC operator then must complete call direction manually by either pressing the Release button or hanging up. The QCC operator does not need to press the Start button to begin the direction process. This allows the QCC operator to speak to the destination and/or announce the call before connecting the caller.

When automatic release is programmed and a QCC operator tries to direct a call to an invalid extension (such as a paging group), the display shows `Denied: Cannot Release`.

NOTES:

- This message also appears immediately if a QCC operator presses the DSS button for ARS or a pool dial-out code. The QCC operator can, however, dial the outside telephone number and release the call manually, even though `Denied: Cannot Release` is shown on the display.
- A QCC operator cannot use Camp-On when automatic release is programmed and she or he presses a DSS button for call direction.

Message Center Operation

The Message Center Operation setting is useful for sending certain types of calls to a specific QCC. Message Center operation designates one or more QCC positions to function as message centers to receive the following calls:

- QCC operator returning calls (returning transferred, parked, held, and camped-on calls).
- Group Coverage calls.

- Calls to unassigned (invalid) extensions received on DID or dial-in tie trunks or made by remote access users.

The factory setting is that no message center position is assigned and that returning calls are returned to the originating operator position (the initiator), which, by definition, is a QCC queue when the system has QCCs. Group Coverage calls are not programmed to ring at any specific QCC operator position. When a message center is programmed, these calls are directed to the message center position. The QCC queue can be programmed so that other QCC operator positions can receive Group Coverage calls, calls to unassigned extensions, and returning calls. If the factory setting remains unchanged—so that returning calls are sent to the originating operator position—then message center operation sends those calls to the programmed message center instead. If, however, this factory setting is changed—so that calls are sent to the QCC queue—returning calls are sent to either the QCC queue or the programmed message center.

A QCC operator position programmed as a message center position also can receive other call types by assigning the position as a QCC operator to receive those call types.

Position Busy Backup

The Position Busy Backup option designates a calling group to receive calls when all QCCs are in a position-busy state. Only calling groups can be designated as QCC position-busy backups. If no calling group is assigned to provide position-busy backup, the system does not allow the last QCC operator to use Position Busy. The Position Busy Backup option is programmed for the QCC queue rather than for individual operator positions. Only one Position Busy Backup can be programmed.

In Release 6.1 and later systems a calling group with a non-local member can be used for Position Busy Backup.

Operator Hold Timer

The Operator Hold Timer option specifies the length of time (10–255 seconds) that must elapse before an operator is reminded (with an abbreviated ring) that a call is on hold. The factory setting for this interval is 60 seconds. The operator hold timer can be set for both DLCs and QCCs. It cannot be programmed for individual operator positions. If another call is received at the same time that the hold timer expires, 10 seconds are added to the programmed operator hold timer interval.

Hold Return

The Hold Return option determines whether calls put on hold at a QCC remain on hold at a QCC operator's console indefinitely or are returned to the QCC queue after the hold timer has expired twice. The factory setting is that calls remain on hold.

When the QCC Hold Return option is set for calls to remain on hold indefinitely, a QCC operator hears an abbreviated ring every time the interval expires. If the QCC Hold Return option is set for calls to return to the queue, each call on hold at a QCC operator console is timed individually (a queue return timer is used for each Call button).

Automatic Hold or Release

The Automatic Hold or Automatic Release setting determines whether a call in progress on a Call button is automatically put on hold (automatic hold) or released (automatic release) when a QCC operator presses another Call button. The factory setting is Automatic Release.

Return Ring Interval

The Return Ring Interval setting determines the number of rings (1–15) before an unanswered directed call returns to the QCC queue or returns to a QCC message center position. The factory setting is four rings.

QCC Voice Announce

If QCC Voice Announce is enabled, the fifth Call button can be used to announce a call on another user's speakerphone. If Voice Announce is disabled (factory setting), then the fifth Call button functions the same as any other Call button. This setting applies to all QCCs in the system. Inspecting this button displays `Call 5 Voice` if Voice Announce for QCCs is enabled and `Call 5 Ring` if Voice Announce for QCCs is not enabled.

QCCs cannot receive Voice Announce calls. Any call to a QCC from a Voice Announce SA button is received at the QCC as a ringing call.

Calls-in-Queue Alert

When the Calls-in-Queue Alert option is enabled for an individual QCC operator, the operator hears a single tone every time a new call enters the queue. By monitoring the calls-in-queue alert, the QCC operator can determine whether heavy call volumes warrant the need for additional answering positions. The factory setting for the Calls-in-Queue Alert option is disabled for each QCC operator.

Queue Over Threshold

The Queue Over Threshold setting is the maximum number of calls allowed in the QCC queue before all QCC operators are warned that too many unanswered calls are waiting in the queue. The factory setting is 0 (operators are not notified). The threshold can be changed to a number in the range of 1–99 calls.

In normal call handling, Line 3 of each QCC operator's display shows the number of calls currently in the queue for that QCC position and the total number of calls in the queue for all QCC operators. The information is updated each time a call

enters or leaves the queue. When the number of calls is equal to or greater than the programmed threshold, the queue indicator is highlighted and QCC operators who are on a call hear a tone.

**NOTE:**

When there are more than 99 calls in the queue, the display shows 99 until the number of calls drops below 99.

If two QCC operators are on the same call, only one QCC operator hears the queue-over-threshold tone when the number of calls in the QCC queue is equal to or greater than the programmed threshold.

Considerations and Constraints

A system operating in Hybrid/PBX mode can include both QCCs and DLCs (see [“Direct-Line Console” on page 231](#)). The system can have a total of eight system operators, which can include no more than four QCCs.

When a system includes QCCs, the first MLX module used to connect QCCs must be installed in the control unit to the left of any other type of module with extension jacks. A QCC can be connected on only the first and fifth extension jack of each MLX module.

Assigning a QCC operator to receive calls to unassigned extension numbers arriving on DID or dial-in tie trunks or from remote access users does not cause these calls to ring into the queue unless the calls are programmed to go to a backup position. The QCC queue must be programmed as the backup position for these calls.

Lines/trunks cannot be programmed to ring into both the QCC queue and a calling group.

Lines/trunks assigned to ring into the QCC queue also can be assigned as personal lines on one or more telephones.

When a QCC operator wants to make an outgoing call, he or she should press the Position Busy button before pressing the Hold button for an existing call. This makes the console temporarily unavailable for calls from the queue (the operator can receive only calls forwarded or made to the operator's individual extension number). If the operator presses only the Hold button, the position is still available for calls and a call can be delivered from the queue. Receipt of a call at this time can either prevent the operator from making the outgoing call or cause the call ringing on the console to remain unanswered until the operator finishes the outgoing call.

Voice announcements do not come over QCC speakerphones.

Features

Queued Call Console (QCC)

581

QCCs have no programmable buttons (all features are factory-assigned) and cannot use feature codes.

If a QCC operator receives a call and another user joins the call by using a shared personal line or Shared SA button, the QCC operator can press the Start button to begin the direction process and then press the Join button to connect all three parties in a conference call. However, the operator cannot release the call; the QCC operator sees the `Denied: Cannot Release` message on the screen.

When a QCC operator is assigned to receive calls on a tie trunk (excluding dial-in tie trunks), and the caller at the other system uses the trunk and dials 0, the call is treated as an unassigned DID call. The QCC operator who receives the call sees `DID#` as the call type (along with the line/trunk label and line/trunk number) on the display, instead of seeing `Dial 0` as the call type.

In Release 3.1 and later systems, if an extension is changed from a Direct-Line Console to a QCC, pool dial-out codes are disallowed on the QCC. You must use system programming if you want to allow access to dial-out codes on the QCC.

Mode Differences

QCCs are available only in Hybrid/PBX mode.

Telephone Differences

Direct-Line Consoles

Both DLCs and QCCs can be assigned in Hybrid/PBX mode. The maximum combined number of operator positions is eight. No more than four can be QCCs.

In a system with both DLC and QCC positions, the primary QCC operator position must be a QCC.

All dial 0 calls are directed to the QCC queue; they do not ring at any DLC positions.

Feature Interactions

Account Code Entry	<p>A QCC operator can use Account Code Entry only by selecting the feature from the display, not by using the feature code. Normally, account codes cannot be entered when a Group Coverage call is answered at a Cover button programmed on a multiline telephone. When the QCC queue is programmed as the receiver for a coverage group, however, the QCC operator can enter account codes and the account code appears on the Station Message Detail Recording (SMDR) printout. This is because Cover buttons are not required when the QCC queue is programmed as a receiver for a coverage group.</p> <p>Forced Account Code Entry can be assigned to a QCC.</p>
Allowed/Disallowed Lists	<p>Allowed and Disallowed Lists can be assigned to a QCC.</p>
Alarm	<p>An Alarm button is assigned as a fixed feature on QCCs.</p>
Authorization Codes	<p>QCCs cannot have authorization codes, and the Authorization Code feature cannot be used from a QCC.</p>
Auto Answer All and Auto Answer Intercom	<p>Auto Answer All and Auto Answer Intercom cannot be assigned to a QCC.</p>
Auto Dial	<p>Auto Dial buttons cannot be programmed on a QCC. For one-touch dialing of extensions, a QCC operator can use the buttons on a DSS or select from the Extension Directory. In addition, a QCC operator can use the System Directory and Personal Directory for one-touch dialing of outside numbers.</p>
Automatic Line Selection	<p>Automatic Line Selection on a QCC is a fixed sequence that starts at the lowest Call button and moves upward. The sequence cannot be changed.</p>
Barge-In	<p>Barge-In allows a QCC operator to contact a person who is busy on a call or using Do Not Disturb. On a QCC, the operator must press the Feature button and select <code>Barge-In</code> from the display. Privacy overrides Barge-In.</p> <p>Barge-In can be used to join only an inside call to a QCC. The caller's extension number must be dialed instead of the QCC operator's extension number. If a user tries Barge-In after dialing a QCC operator's extension (while waiting in the QCC queue), the feature has no effect and the user hears an error tone. If the error tone times out while the call is still in the QCC queue, the call is disconnected. If the QCC operator becomes available before the error tone times out, the error tone is removed and the call is delivered to the QCC operator normally.</p>
Callback	<p>Calls to QCCs are not eligible for Callback because the calls ring into the QCC queue. Callback cannot be used on a QCC.</p>
Calling Restrictions	<p>Calling restrictions can be assigned to QCCs.</p>

Camp-On

A QCC operator can release a call to a busy extension either by selecting **Camp On** from the display or by pressing the **Release** button. If **Camp-On** is used, the call does not return to the QCC queue until the **Camp-On** return interval expires. If the operator presses the **Release** button, the extension being called receives the call-waiting tone and the call returns to the QCC queue when the transfer return interval expires.

To use **Camp-On** when the system is programmed for automatic extended call completion, an operator presses the **Start** button, dials the extension manually, then selects **Camp On** from the display. If the operator presses a **DSS** button, the transfer is completed automatically and **Camp-On** cannot be used.

Conference

When a QCC operator arranges a conference call on a QCC, all conference participants (maximum of 5) are connected on one **Call** button. This allows the QCC operator to put the conference on hold and have other **Call** buttons available to make or receive calls. However, because all participants are on one **Call** button, the operator can drop only the last person added to the conference by first pressing the **Drop** button and then the **Call** button for the conference.

When a QCC operator arranges a three-party conference (the operator and two other participants) and then presses the **Release** button or hangs up, the QCC operator is released from the call and the other two participants remain connected. If the QCC operator arranges a four- or five-party conference, the **Release** button has no effect. If the QCC operator hangs up or presses the **Hold** button, the QCC operator is released and the remaining conference participants remain connected. The **Forced Release** button disconnects all parties from the call.

Coverage

An individual QCC operator cannot be a sender or receiver for **Individual** or **Group Coverage**. However, the QCC queue can be a receiver for up to 30 coverage groups when one or more QCC operators are assigned to receive the calls. The QCC queue can be assigned as a receiver in addition to multiline telephones programmed with **Group Cover** buttons; the QCC queue is not counted in the 8-receiver maximum for each group. The QCC queue priority and the individual QCC operator to receive **Group Coverage** calls are set independently for each group.

If **Group Cover** buttons are programmed for a coverage group in addition to the QCC queue and if all QCC operators are in the position-busy state, a **Group Coverage** call does not go to the backup calling group.

When the QCC queue is programmed as a receiver for a coverage group and a personal line on a coverage group member's extension is also programmed to ring into the QCC queue, calls received on that personal line are not sent to the queue as coverage calls. Calls received on the personal line, however, can be sent to multiline telephone group coverage receivers.

Features

Queued Call Console (QCC)

584

**Coverage
(continued)**

When the QCC queue is programmed as a receiver for a coverage group and a call transferred to a group member is not answered, the call returns to the queue as a transfer return if the QCC return ring interval is shorter than the coverage delay. If the QCC return ring interval is longer than the coverage delay, the call returns to the QCC queue as a Group Coverage call.

CTI Link

In a system that includes a CTI link, a call to a QCC does not initiate screen pop at the operator position, which cannot use a CTI application. It can initiate screen pop at an extension that supports screen pop either when an operator transfers or conferences a call immediately, or while the operator talks to the system user before transferring or conferencing a call.

**Direct Station
Selector**

In Release 6.1 and later systems DSS buttons can be used to dial non-local extensions or to transfer calls. No busy indications, however, appear on the DSS for non-local extensions.

When a QCC is forced-idle, the DSS LED at another extension for the QCC does not light.

In Release 7.0 and later systems, if you go off-hook on the receiver or the speakerphone of the QCC and then press the Headset Status button to use the headset, the DSS LED for the QCC remains lit.

In Release 7.0 and later systems, if you enter programming mode while using the headset, the DSS LED at another extension for the QCC turns on. When you exit programming mode, the DSS LED remains on. If you are *not* using the headset and exit programming mode, the DSS LED turns off.

In Release 7.0 and later systems, if you are on a call using the headset, enter programming mode, and the far-end hangs up, the DSS LED turns off, even though you are still in programming mode.

Direct Voice Mail

The Direct Voice Mail button is factory-assigned on DSSs connected to QCCs.

Directories

QCC operators use Directory features to dial extensions or telephone numbers with the touch of a button. The Extension Directory allows an operator to locate and dial system extension numbers. The System Directory and Personal Directory can be used to locate and dial outside numbers. Directory features can be used for directing calls. However, if a QCC operator releases the call immediately after pressing the button for the listing, the caller hears the dial tone plus the touch tones for the dialed digits. If the operator waits until after dialing begins, the caller does not hear the dial tone and touch tones.

Display	Features not assigned to buttons on the QCC can be activated only by selecting them from the display. A QCC operator also uses the display for call information, such as the person or extension calling, the line/trunk identifiers, the reasons for call return and redirection, and the number of calls waiting in the queue. When a call is in a split condition, a QCC operator sees information about both the source and destination. If the operator presses the Home button under these circumstances, the message is replaced with information about the source only. The operator can restore the information by pressing the Source and Destination buttons, or by pressing the Inspct button followed by the Source or Destination button.
Do Not Disturb	Do Not Disturb cannot be used on a QCC. Instead, the operator must use Position Busy.
Extension Status	Extension Status cannot be used on a QCC, and a QCC cannot be a calling group member or a CMS or calling group supervisor.
Forward and Follow Me	<p>A QCC operator cannot forward calls to extensions or telephone numbers. Instead, the operator uses Position Busy to send calls to a backup calling group.</p> <p>Calls that are forwarded to an individual QCC operator or Follow Me calls that are signed in to a QCC can be assigned a queue priority level. When the QCC operator uses Position Busy, forwarded calls and Follow Me calls signed in to the QCC position continue to ring at the QCC.</p>
Group Calling	<p>Only a calling group can be programmed to provide Position Busy backup when all QCC operators activate Position Busy. If no calling group is designated to provide backup, the system does not allow the last QCC operator to activate Position Busy. A QCC cannot be a member of a calling group. A calling group can be a backup for calls in the QCC queue when all QCC operators are in the position-busy state. The QCC queue can be designated to provide overflow coverage for calls from one or more calling groups. When an overflow call is sent to the QCC queue, it cannot be distinguished as a call to a calling group.</p> <p>In Release 6.1 and later systems a calling group with a non-local member can be used for Position Busy Backup.</p> <p>In Release 6.0 and later systems (Hybrid/PBX mode only), inside, dial 0, or LDN calls directed to a calling group programmed as the Position Busy Backup are subject to queue control.</p> <p>When the QCC queue is providing overflow coverage for a calling group and all QCC operators are in the position-busy state, overflow calls do not receive position-busy backup (are not redirected to a second calling group providing position-busy backup for the QCC queue) and continue to wait in the original calling group queue.</p> <p>If all QCC operators activate Position Busy while an overflow call is in the QCC queue, the call is rerouted to the original calling group, not to the calling group providing position-busy backup.</p>

Group Calling <i>(continued)</i>	If a QCC operator switches out of Position Busy while a backup call is in the calling group queue or has already been delivered to a calling group member, the call does not go back into the QCC queue.
Headset Options	Headset Auto Answer, Headset/Handset Mute, and Headset Status are assigned as fixed features on buttons on a QCC. Headset Hang Up cannot be programmed on a QCC. The function of disconnecting calls served by the Headset Hang Up feature is replaced with Release, Forced Release, Camp-On, and Automatic Release through DSS buttons on the QCC.
HFAI	The Hands Free Answer on Intercom (HFAI) button does not work on a QCC.
Hold	Pressing the Hold button to put a caller on hold makes a QCC operator available for incoming calls from the QCC queue. The DLC operator Automatic Hold feature is not used for QCCs.
Inspect	When a participant joins a conference call by using a shared outside line or a Shared SA button, the QCC display shows the correct number of participants. However, if the QCC operator uses the Inspect feature to verify the number of participants, the displayed number does not include participants joining the conference call on SSA buttons. Pressing any of the buttons programmed with fixed QCC features (for example, a Call or Source button) while in Inspect mode does not remove the console from Inspect mode. Pressing the Feature, Transfer, HFAI, Conf, Drop, Speaker, or Hold button, however, removes the console from Inspect mode.
Last Number Dial	Last Number Dial cannot be used on a QCC.
Line Request	Line Request cannot be used on a QCC.
Messaging	A QCC operator can use Leave Message only by selecting the feature from the display. A Send/Remove Message button is programmed as a fixed feature on a QCC.
Microphone Disable	The microphone on a QCC is automatically disabled and cannot be enabled.
Multi-Function Module	An MFM cannot be connected to an MLX-20L telephone assigned as a QCC. As a result, adjuncts such as answering machines and fax machines cannot be used with the console.
Night Service	A Night Service button is assigned as a fixed feature on a QCC. When multiple Night Service calls are received in the QCC queue at the same time and none of the calls are answered by a Night Service member (all group member ICOM or SA buttons are busy), new calls are sent to the QCC queue and can be answered only by a QCC operator. To avoid this situation, all outside lines assigned to ring in to the QCC queue should be assigned as personal lines on at least one group member's extension.

Features

Queued Call Console (QCC)

587

Night Service (continued)

In Release 4.1 and later systems, Night Service lines must be assigned to a Night Service group; they need not appear at the operator position for the group. Lines that are assigned to the Night Service operator receive Night Service operation only if they are assigned to the group.

In Release 4.0 and prior systems, if more than one QCC operator is assigned to receive calls on an individual line/trunk, Night Service must be turned on at *all* assigned positions before calls coming in on the line/trunk can ring on extensions programmed as members of the Night Service group. If Night Service is not turned on at the QCC position programmed to receive the calls, after-hours calls ring at that position and do not receive Night Service treatment.

Paging

A QCC cannot make or receive voice-announced inside calls (speakerphone calls to an extension). A QCC cannot be a member of a speakerphone paging group. A QCC operator can use a loudspeaker paging system only by selecting the feature from the display. He or she can use the Group Paging feature either by selecting a Call button and pressing the DSS button or by dialing the extension for the paging group.

Park

Eight park dial codes are automatically reserved for parking calls from a QCC. The factory-set extension numbers are 881 through 888. To assign the park zones to a DSS connected to a QCC, the extension numbers must be in the range programmed for the Page buttons.

A QCC operator with a DSS parks a call either by pressing the DSS button for the park zone or by pressing the Start button and then the DSS button. The call is automatically parked; the operator does not need to press the Release button. A QCC operator without a DSS cannot park calls.

To pick up a parked call, a QCC operator presses the Feature button and selects `PickUp` from the display, then dials the extension number for the extension or park zone where the call is parked.

Calls parked by QCC operators can be programmed to return to the QCC operator who parked the calls and/or to another QCC operator. Returning parked calls are also assigned a QCC queue priority level; the factory setting is 4. With message center operation, a call parked by a QCC operator can be returned to the message center position.

Personal Lines

Personal lines cannot be assigned to a QCC.

Pickup

A QCC can be a member of a Pickup group. QCC operators can use Individual Pickup and Group Pickup only by selecting them from the display. `Individual Pickup` and `Group Pickup` are available from the Home screen on QCCs.

Features

Queued Call Console (QCC)

588

Pools	<p>Pool buttons cannot be assigned to a QCC, but a QCC operator can select pools to make outgoing calls by pressing a Call button and dialing the ARS or pool dial-out code. A QCC operator can be assigned to receive calls on lines/trunks assigned to pools.</p> <p>A Pool Status button is assigned as a fixed-feature button on a QCC and provides a QCC operator with the status of all pools (maximum of 11), including pools of private-network trunks (Release 6.0 and later systems). The QCC operator presses the Inspct button followed by the Pool Status button, and the busy or available status of pools is shown on the display.</p>
Privacy	<p>A QCC operator cannot use Privacy.</p>
Recall/Timed Flash	<p>A Recall button cannot be programmed on a QCC.</p>
Reminder Service	<p>Reminder service cannot be used on a QCC.</p>
Remote Access	<p>If a remote caller uses a rotary telephone and the system does not require a barrier code, the call, after it times out, is sent to a QCC that is assigned as a backup extension.</p> <p>One or more QCC operators can be assigned to receive calls on lines/trunks programmed for shared remote access.</p> <p>In Release 4.1 and later systems, if a remote access line is assigned to one or more Night Service groups, it receives Night Service treatment when <i>any</i> QCC operator whose group includes the line turns Night Service on.</p> <p>In Release 4.0 and prior systems, calls received on lines/trunks specified for shared remote access receive remote access treatment only when <i>all</i> QCC operators who are assigned to receive shared remote access calls turn on Night Service. If Night Service is turned off by one or more QCC operators assigned to receive the calls, calls ring in to the QCC queue normally and do not receive remote access treatment.</p>
Ringling/Idle Line Preference	<p>Ringling/Idle Line Preference is turned on and cannot be turned off on a QCC.</p>
Ringling Options	<p>Personalized ringling cannot be programmed on a QCC, nor can Ring Timing options be adjusted on a QCC. The Call buttons are fixed to Immediate Ring. A QCC receives only two types of distinctive ringling: one ring for an inside call and two rings for an outside call. A QCC does not receive the three rings that indicate a returning transferred call.</p>
Saved Number Dial	<p>Saved Number Dial cannot be used on a QCC.</p>
Service Observing	<p>In Release 6.1 and later systems, a QCC cannot be a Service Observer or a member of a Service Observing group. If an extension is on a call with a QCC, the call can be observed at that extension, but not at the QCC's extension.</p>

Signal/Notify	<p>Notify and Signal buttons cannot be used on a QCC. However, pressing a DSS button sends a signal to the extension associated with the DSS button in the following instances:</p> <ul style="list-style-type: none">■ A QCC operator is timed out from dial tone on a Call button or has pressed the Forced Release button while listening to dial tone on a Call button.■ A QCC operator, with the call in a split condition, has pressed the Source button after contacting the destination but has not connected both parties by using the Join button. If the operator presses a DSS button, a manual signal is sent to the destination extension.
Speed Dial	<p>Personal Speed Dial and System Speed Dial cannot be used to dial numbers on a QCC. The Directory features are used instead.</p>
SMDR	<p>When a QCC operator arranges a three-party conference (the operator and two other participants) and presses the Release button, the operator is released from the call and the other two participants remain connected. Although this process is similar to directing a call, the QCC operator's extension remains on the SMDR record.</p> <p>In Release 4.2 and later systems, if a calling group is programmed as the backup for the QCC queue and all QCC operators are temporarily unavailable, an incoming call is sent to the calling group queue to wait for the next available agent. SMDR records this type of call in the same way it does other incoming calls to Auto Login and Auto Logout calling groups.</p>
System Access/ Intercom Buttons	<p>SA buttons are not assigned on a QCC. A QCC operator uses Call buttons to make and receive inside and outside calls.</p>
System Renumbering	<p>The LDN (the extension number for the QCC queue) can be renumbered. The factory-set extension is 800.</p>
Transfer	<p>A QCC operator uses the Start and Release buttons or a DSS button to transfer calls. Pressing the Transfer button on a QCC, however, is the same as pressing the Start button. A QCC operator cannot make or receive voice-announced transfers. When the operator uses the Start and Release buttons to transfer a call, the return ring interval, rather than the transfer return interval, applies for transfer return timing.</p>
UDP Features	<p>In Release 6.1 and later systems if a system operator transfers a call to a non-local extension by using a DSS with one-touch Transfer with Automatic Extended Call Completion, the Caller ID information is sent if PRI tandem trunks are used.</p>
Voice Announce	<p>Voice announcements cannot be received on a QCC. The ability to make Voice Announce calls can be turned on at a QCC in Release 4.0 and later releases only.</p>

Recall/Timed Flash

At a Glance

Users Affected	Telephone users, DLC operators
Reports Affected	Extension Information, System Information (SysSet-up)
Modes	All
Telephones	All except QCC
Programming Codes	
Recall	*775
Conference	*772 (Behind Switch mode only)
Drop	*773 (Behind Switch mode only)
Transfer	*774 (Behind Switch mode only)
Feature Code	775
MLX Display Label	Recall [Rec11]
System Programming	Change timed-flash duration (recall timer): <ul style="list-style-type: none"> ■ Options→More→RecallTimer Program fixed Conference, Drop, and Transfer buttons to access host features in Behind Switch mode: <ul style="list-style-type: none"> ■ Options→More→BehndSwitch→Conference/Drop/Transfer
Factory Setting	
Recall Timer	450 ms (options 350 ms, 450 ms, 650 ms, 1 sec)

Description

Recall sends a momentary signal called a *timed flash* or *switchhook flash* while the telephone is on the hook. A timed flash is used as a control signal, as follows:

- On an inside call, the signal is intercepted by the control unit.
 - A multiline telephone user can use Recall to disconnect a call and get a new dial tone without hanging up. The user can be on an active call or listening to ringback or dial tone. When the user is listening to a busy signal, Recall has no effect.
 - A single-line telephone user can use Recall to put an active call on hold and to access system features such as Conference and Transfer.
- On an outside call, when the system is using host switch services such as Centrex, the signal may be sent to the host, depending on the type of telephone and system operating mode.

- A multiline telephone user can use Recall to access host features. The user can be connected to another party or can be listening to outside dial tone, ringback, or a busy signal.
- A single-line telephone user can use Recall to access host services only if the system is programmed for Behind Switch mode.

Recall is used by pressing a fixed or programmed Recall button (or Flash button on some single-line telephones) or dialing the Recall feature code. The Recall timer, which specifies the duration of the switchhook flash, is set through system programming. The duration required by the host switch is specified by the local telephone company.

The Recall timer should be reset if multiline telephone users experience either of the following problems:

- When the user presses the Recall button on an outside call, nothing happens. This indicates that the interval is too short and should be increased to 650 milliseconds or 1 second.
- In a system operating in Behind Switch mode, when the user presses the Recall button on an outside call, the call is disconnected. This indicates that the interval is too long and should be decreased to 350 ms.

Release Differences

Release 1.0 and Release 1.1

Recall can be used on an outside call only if the call has been made or received on a personal line or Pool button. Recall cannot be used on an outside call made or received on an SA or ICOM button.

Release 2.0 and Later

In addition to its use on calls made or received on a personal line or Pool button, Recall can be used on an outside call made or received on an SA (including Shared SA) or ICOM button. This includes the following kinds of calls:

- Transferred, group, and forwarded calls received on SA or ICOM buttons.
- ARS calls and calls made using pool dial-out codes (on SA buttons) or Idle Line Access codes (on ICOM buttons).

When used after dialing is completed on an outside line/trunk, Recall sends a timed flash to the host switch, the line/trunk is kept, the user hears a new outside dial tone, and calling restrictions are reapplied. On an ARS call or a call on a rotary-dial line/trunk, Recall cannot be used until dialing is completed. On a call made using the pool dial-out code, Recall can be used during, as well as after, dialing. Recall can be used only on loop-start lines.

Considerations and Constraints

Recall can be used to send a timed flash to the host switch only on loop-start lines.

The Recall or Flash button sends a switchhook flash. It is not a “redial” button.

Mode Differences



NOTE:

There are no fixed Drop buttons on ETR and MLS telephones. Therefore, ETR Drop buttons must be programmed on these telephones to operate like the fixed Drop buttons on MLX and analog multiline telephones.

Hybrid/PBX Mode

In Release 1.0 and 1.1 systems, Recall cannot be used on any outside call made or received on an SA button. In Release 2.0 and later systems, this restriction is removed.

A Recall signal from a single-line telephone accesses the communications system's Hold, Conference, and Transfer features.

Key Mode

In Release 1.0 and 1.1 systems, Recall cannot be used on any outside call made or received on an ICOM button. In Release 2.0 and later systems, this restriction is removed.

A Recall signal from a single-line telephone accesses the communications system's Hold, Conference, and Transfer features.

Behind Switch Mode

If Recall is used on a call made or answered on the prime line, the timed flash is sent to the host switch.

The fixed Conf, Drop, and Transfer buttons on MLX, ETR, MLS, or analog multiline telephones must be programmed through system programming to send the codes required by the host system. Most host systems use a timed flash plus the code features on the host. Once this programming is done, the fixed buttons have no effect on the MERLIN LEGEND System when pressed during an inside call.

If use of the communications system's Conference, Drop, and Transfer features is also desired, they must be programmed on available line buttons on multiline

telephones, using either extension programming or centralized telephone programming.

In Release 1.0 and 1.1 systems, Recall cannot be used on any outside call made or received on an ICOM button. In Release 2.0 and later systems, this restriction is removed.

A Recall signal from a single-line telephone is ordinarily sent to the host switch because the factory setting for the Automatic Line Selection (ALS) sequence selects the prime line. The Automatic Line Selection sequence, however, can be programmed via Centralized Telephone Programming to give access to Intercom buttons. Users then can make Intercom calls and use Feature Access Codes, but cannot access the system's Hold, Transfer, Conference, and Drop features.

Telephone Differences

Queued Call Consoles

A QCC cannot use Recall. A Recall button cannot be programmed on the QCC, nor can the QCC use the Recall feature code.

Other Multiline Telephones

Analog multiline BIS telephones have a fixed Recall button that can be pressed to access the Recall feature.

MLX, ETR, MLS, and cordless/wireless telephone users can use Recall by pressing the Feature button and dialing 775, but it is recommended that a Recall button be programmed instead.

To activate host system features in Behind Switch mode, the fixed Conf, Drop, and Transfer buttons (including the programmed ETR Drop button) on an MLX, ETR, MLS, or analog multiline telephone must be programmed through system programming to send the codes required by the host system. Most host systems use a timed flash plus the code features on the host. Once this programming is done, the fixed buttons have no effect on the MERLIN LEGEND System when pressed during an inside call.

If use of the communications system's Conference, Drop, and Transfer features is also desired in Behind Switch mode, they must be programmed on available line buttons on each multiline telephone, using either extension programming or centralized telephone programming.

Single-Line Telephones

A single-line telephone user without a Recall or Flash button must use the switchhook to send a timed flash. The communications system intercepts the signal; if it is to be sent on to a host switch, the system sends a signal of the duration programmed for the Recall timer.

In Hybrid/PBX or Key mode, a Recall signal from a single-line telephone accesses the communications system's Hold, Conference, and Transfer features.

In Behind Switch mode, a Recall signal from a single-line telephone is ordinarily sent to the host switch because the factory setting for the ALS sequence selects the prime line. If the call is on an Intercom button, the MERLIN LEGEND's Flash processing interprets flashes as Recall button presses. The current call is dropped from the telephone, and a new dial tone is applied.

NOTES:

- If a single-line telephone with a timed or positive disconnect is used, pressing the switchhook disconnects the call. With this type of telephone, the Recall or Flash button must be used instead of the switchhook for features that require a switchhook flash.
- A single-line telephone user without a Recall or Flash button, or with buttons that activate telephone-only features, must press and release the switchhook to send a timed flash.
- A single-line telephone user who has a 2500 YMGL or 8110M telephone with positive disconnect on *cannot* press the switchhook to activate features. The user must press the Hold button or the Flash button to activate a feature. (The 8100M telephone must have positive disconnect programmed on the telephone as described in its manual.)

Feature Interactions

Allowed/ Disallowed Lists and Calling Restrictions

If Recall is used on a personal line or Pool button—or, in Release 2.0 and later systems, on an SA or ICOM button—to access an outside loop-start line, the accessed line is kept, the user hears outside dial tone, and calling restrictions are reapplied.

Auto Dial

The Conf button is used to enter the Flash special character, which simulates pressing the Recall button, in a telephone number programmed on an Auto Dial button.

If Recall is used during an inside call made on an Auto Dial button, the call is disconnected and the user hears inside dial tone.

Automatic Route Selection	<p>In Release 2.0 and later systems, Recall can be used on an ARS call. Recall cannot be used during dialing. When dialing is complete, pressing the Recall button sends a timed flash to the host, the accessed line is kept, the user hears outside dial tone, and calling restrictions are reapplied.</p> <p>In Release 1.0 and 1.1 systems, Recall cannot be used on an ARS call because the call is made on an SA button.</p>
Barge-In	<p>In Release 2.0 and later systems, Recall can be used by either party on a call joined using Barge-In.</p> <p>In Release 1.0 and 1.1 systems, Recall cannot be used with Barge-In.</p>
Basic Rate Interface	<p>Recall is not recognized by the central office on BRI lines. Thus, the central office ignores a press of the Recall button.</p>
Callback	<p>If Recall is used while a user is off hook with a queued callback request, the call is disconnected and the user hears dial tone.</p>
Call Waiting	<p>If Recall is used while a user is hearing special ringback, the call is disconnected and the user hears inside dial tone.</p>
Conference	<p>The Conf button is used to enter the Flash special character, which simulates pressing the Recall button in telephone numbers programmed for Directories, Auto Dial buttons, or Speed Dial codes.</p> <p>In Hybrid/PBX and Key modes, a single-line telephone user with a Recall or Flash button can add a participant to a conference call and connect all participants by using the Recall or Flash button. In addition, the Recall or Flash button can be used either to drop the most recently added participant or to drop a busy number.</p> <p>In Behind Switch mode, the fixed Conf button on an MLX, ETR, MLS, or analog multiline telephone must be set through system programming to send a timed flash plus the code expected by the host switch to activate conference on the host. If the communications system's Conference feature is also desired, it must be assigned to an available line button on each multiline telephone through extension or centralized telephone programming. Recall has no effect on a completed conference call.</p>
Coverage	<p>Recall has no effect on a call answered on a Primary Cover, Secondary Cover, or Group Cover button.</p> <p>In Release 2.0 and later systems, Recall can be used on a Group Coverage call answered by a member of a calling group. In Release 1.0 and 1.1 systems, Recall cannot be used on a call of this type because it is answered on an SA or ICOM button.</p>
Directories	<p>The Conf button is used to enter the Flash special character, which simulates pressing the Recall button in a Directory listing telephone number.</p>

Display	When an MLX or ETR telephone user presses a programmed Recall button while on an outside line, the line information is redisplayed just as if the user had gone off hook on the line.
Forward and Follow Me	A multiline telephone user on an inside Forward or Follow Me call can use Recall. In Release 2.0 and later systems, Recall also can be used on an outside call received on a loop-start line.
Group Calling Hold	A user who has received an inside calling group call can use Recall. A single-line telephone user with a Recall or Flash button can press Recall or Flash to put a call on hold.
HotLine	A switchhook flash from a HotLine extension (Release 5.0 and later systems) is not transmitted to the system or central office.
Multi-Function Module	An MFM cannot send a timed flash. As a result, a single-line telephone or other device connected to an MFM cannot use Recall.
Last Number Dial	Recall can be used on a Last Number Dial call on a personal line, Pool button (loop-start only), an inside call or, in Release 2.0 and later systems, an outside call on a loop-start line using an SA or ICOM button.
Night Service	A user (except a QCC operator) on an inside Night Service call can use Recall. In Release 2.0 and later systems, Recall also can be used on outside calls received on loop-start lines.
Park	A single-line telephone user can press a Recall or Flash button for Park.
Personal Lines	When two users have joined an outside call on a shared personal line (loop-start only), Recall can be used by either inside party.
Pools	If a user presses the Recall button during or after dialing, a timed flash is sent to the host switch, the accessed line is kept, the user hears dial tone, and calling restrictions are reapplied.
Privacy	A single-line telephone user with a Recall or Flash button can use the button to turn Privacy on or off during a call.
Reminder Service	Recall can be used to disconnect an answered reminder call.
Saved Number Dial	Recall can be used on a Saved Number Dial call on a personal line, Pool button (loop-start only), an inside call, or, in Release 2.0 and later, an outside call made on a loop-start line using an SA or ICOM button.
SMDR	Each time Recall/Timed Flash is used on a call, a new Station Message Detail Recording record is generated. For example, if a user is active on a call and uses Recall to initiate a conference call, SMDR timing is stopped for the original call and a new record is begun. If the user then calls a second party and uses Recall again to join the conference parties, a third SMDR record is generated with an empty CALLED NUMBER field.
Speed Dial	The Conf button is used to enter the Flash special character, which simulates pressing the Recall button in a Personal Speed Dial or System Speed Dial telephone number.

Features

Recall/Timed Flash

597

System Access/ Intercom Buttons

Recall can be used on a ringing or answered inside call made on an SA or ICOM button. The call is disconnected and the user hears dial tone. When the user is listening to a busy signal, Recall has no effect.

Either the user with the principal SA button or the user with a Shared SA button who has joined a call can use Recall. In Release 2.0 and later systems, Recall is available on an outside call on a loop-start line when the call is made or received on the SA or Shared SA button.

Transfer

A single-line telephone user with a Recall or Flash button can use it to transfer a call.

In Release 2.0 and later systems, Recall is available on a transferred outside call on a loop-start line (the transfer arrives on an SA or ICOM button).

In Behind Switch mode, the fixed Transfer button on an MLX or analog multiline telephone must be programmed through system programming to send a timed flash plus the code expected by the host switch to activate transfer on the host. To use the communications system's Transfer feature as well, the feature must be programmed on an available line button on each multiline telephone, using extension or centralized telephone programming.

Reminder Service

At a Glance

Users Affected	Telephone users, DLC operators
Reports Affected	Extension Information, System Information (SysSet-up)
Modes	All
Telephones	All except QCC
Programming Codes	
Set	*81
Cancel	**81
Missed Reminder	*752 (operators only)
Feature Codes	
Set (users)	81 + time + A or P (see note)
Set (operators)	81 + Auto Dial or DSS button + time + A or P (see note)
Cancel (users)	*81
Cancel (operators)	*81 + Auto Dial or DSS button
MLX Display Labels	
Set	Reminder,Set [Rmind,Set]
Cancel	Reminder,Cancel [Rmind,Cancel]
Missed Reminder	Reminder,Missed [Rmind,Missd]
System Programming	Set time of day when all reminders are automatically canceled: ■ Options→ReminderSrv



NOTES:

- In Release 1.1 and later systems, do not use the A or P on telephones programmed for French or Spanish; on these telephones, time is entered in 24-hour format. In Release 1.0 systems, time *must* be entered in 12-hour format, using A or P, for telephones programmed in English, French, or Spanish.
- Operators cannot enter Reminder extensions from the dialpad. Instead, they must use Auto Dial buttons or a DSS.

Description

With Reminder service, users can arrange for the system to make reminder calls at preset times. Users can set and cancel reminder calls for their own telephones. Direct-Line Console (DLC) operators can set and cancel Reminder service for any telephone in the system (for example, to alert several telephones as a reminder for a meeting or, in a hotel or motel, for wake-up call service). Although reminder

service is available for all telephone users, the Alarm Clock feature for display telephones is easier to use and more effective for most purposes. (See [“Alarm Clock” on page 40](#) for more information.)

When Reminder service is set for a telephone, the system makes a call to the extension at or close to the preset time. (Reminder calls may arrive up to three minutes before or after the set time.) The call rings for 30 seconds or until the telephone is answered. When the call is answered, the reminder is canceled.

If a reminder call is not answered or the telephone is busy, the call is considered a missed reminder. If Reminder service has been set and the call is not answered, the green LED flashes next to the Missed Reminder button on the operator's console.

An operator with a display console can press the Missed Reminder button to display any missed reminder messages. This message identifies the name and extension of the missed reminder call, along with the set time for the reminder. The green LED next to the Missed Reminder button lights steadily while missed reminder call messages are being read. After the messages have been read, the operator can use Reminder service to resend a reminder call to an extension. The operator can then clear the missed reminder by pressing the programmed Missed Reminder and Reminder Cancel buttons.

Through system programming, all outstanding reminders can be canceled by the system at a preset time every day—for example, after business hours when not all users are available to answer reminder calls.

Considerations and Constraints

The system time must be set in order for people to use Reminder service. Reminders use system time, which can differ from the time set by a user at an analog multiline display telephone.

Missed Reminder buttons can be programmed only on operator display consoles, because the display is needed to show missed reminder information. To activate, the operator's console must have either a DSS or inside Auto Dial buttons to access extensions. This feature cannot be used by dialing an extension from the dialpad.

The green LED next to the Missed Reminder button lights steadily to indicate that the operator can read missed reminder messages. Reminder Set cannot be used to set a reminder time until the missed reminders are canceled.

Only one reminder at a time can be set for a telephone. Reminders do not carry over to the next day; they are sent only once and are either received or missed.

Missed reminders can be canceled only by an operator. A missed reminder stays on the system until canceled. If a time for a reminder is already set, it is shown on display telephones when the Reminder button is pressed.

Telephone Differences

Direct-Line Consoles

DLC operators can use Reminder service to set or cancel reminders for other users. An operator with a DLC sets a reminder for another telephone by:

- Pressing a programmed Reminder Set button, or pressing the Feature button and dialing 81.
- Pressing an Auto Dial or DSS button.
- Dialing a 4-digit time, 0100 to 1259 and either 2 for a.m. or 7 for p.m. on telephones programmed for English, or 0000 to 2359 on telephones programmed for French or Spanish (Release 1.1 and later).



NOTES:

- To cancel a reminder for another telephone, an operator presses a programmed Reminder Cancel button, or presses the Feature button and dials *81. Then the operator uses an Auto Dial or DSS button.
- An operator also can see when a reminder was missed and cancel missed reminders. The Missed Reminder button can be programmed on DLC operator consoles only.
- In Release 1.0 systems, time must be programmed in 12-hour format.

Queued Call Consoles

Reminder service cannot be used on a QCC.

Other Multiline Telephones

Multiline telephone users set reminders for their telephones either by pressing a programmed Reminder Set button, or by pressing the Feature button and dialing 81. Then users enter the time as follows:

- In Release 1.1 and later systems:
 - On telephones programmed for English, the time is entered in 12-hour format in the range from 0100 to 1259 and either 2 (A) for a.m. or 7 (P) for p.m.
 - On telephones programmed for French or Spanish, enter the time is entered in 24-hour format in the range from 0000 to 2359.

- In Release 1.0 systems, the time is entered in 12-hour format in the range from 0100 to 1259 and either 2 (A) for a.m. or 7 (P) for p.m.

To cancel a reminder, the user either presses a programmed Reminder Cancel button, or presses the Feature button and dials *81.

Reminder service cannot be used on MLC-5 cordless telephones.

Single-Line Telephones

To set a reminder, lift the handset and (while listening to inside dial tone) dial #81 and a 4-digit time (0100–1259), and either 2 for a.m. or 7 for p.m. To cancel a reminder, lift the handset (the telephone must connect to an SA or ICOM button) and dial #*81.

Feature Interactions

Callback	Reminder calls cannot be queued by using Callback.
Call Waiting	Reminder calls are not eligible for Call Waiting.
Coverage	Reminder calls are not eligible for Individual or Group Coverage.
Digital Data Calls	Digital communications devices and Videoconferencing systems cannot receive reminder calls.
Display	See “Display” on page 271 .
Do Not Disturb	Reminder calls ring at telephones with Do Not Disturb activated.
HotLine	HotLine extensions cannot dial the feature (#) codes for Reminders.
Language Choice	The time settings for Reminder service must be entered in accordance with the language selection governing the extension. If the language selection is English, the time setting for Reminder service must be entered in 12-hour format (0100–1259) followed by either a 2 (A) for a.m. or a 7 (P) for p.m. If the governing language selection is French or Spanish, the time setting must be entered in 24-hour format (0000–2359).
Recall/Timed Flash	Recall can be used to disconnect an answered reminder call.
Ringing Options	A reminder call overrides programmed Ring Timing options (Delay Ring and No Ring) and rings with a priority ring at an SA or ICOM button.
Service Observing	In Release 6.1 and later systems, Service Observers can observe Reminder service calls. If a Service Observer is setting or cancelling Reminder service, he or she can observe calls.
System Access/ Intercom Buttons	A reminder call overrides programmed Ring Timing options (Delay Ring and No Ring) and rings at the principal extension; reminder calls do not ring at Shared SA buttons.
UDP Features	In Release 6.0 and later systems (Hybrid/PBX mode only), Reminder service does not function across a private network.

Remote Access

At a Glance

Users Affected	Telephone users, operators, data users
Reports Affected	Remote Access (DISA) Information, SMDR
Modes	All
Telephones	Touch-tone only
System Programming	<p>Assign dedicated or shared remote access to lines/trunks:</p> <ul style="list-style-type: none"> ■ LinesTrunks→RemoteAccss→LinesTrunks <p>If barrier codes are not used, assign class of restrictions to lines/trunks:</p> <ul style="list-style-type: none"> ■ LinesTrunks→RemoteAccss→Non-Tie/Tie Lines→Restriction/ARS Restrct/AllowList/DisallowList <p>Assign class of restriction for each barrier code:</p> <ul style="list-style-type: none"> ■ LinesTrunks→RemoteAccss→BarrierCode Restriction/ARS Restrct/AllowList/DisallowList <p>Specify that barrier codes are required for remote access:</p> <ul style="list-style-type: none"> ■ LinesTrunks→RemoteAccss→Non-Tie/Tie Lines→BarrierCode <p>Add, change, or remove individual barrier codes, or change length of all barrier codes:</p> <ul style="list-style-type: none"> ■ LinesTrunks→RemoteAccss→BarrierCode→CodeInfo <p>Assign barrier codes to remote access system programming lines/trunks (nonfunctional; do not use):</p> <ul style="list-style-type: none"> ■ LinesTrunks→RemoteAccss→BarrierCode→SProgMaint <p>Enable or disable Callback for busy pools:</p> <ul style="list-style-type: none"> ■ LinesTrunks→RemoteAccss→AutoQueuing <p>Specify destination of remote access calls to unassigned numbers:</p> <ul style="list-style-type: none"> ■ Options→More→Unassigned <p>Change remote access code:</p> <ul style="list-style-type: none"> ■ SysReNumber→Single→RemoteAccs
Maximums	16 barrier codes, with a 4- to 11-digit length (set systemwide), using 0–9 and dialpad characters. All barrier codes are deleted when the systemwide barrier code length is changed.

Factory Settings

ARS FRL for Barrier Codes or Lines/Trunks	0
Autoqueuing	Disabled
Restriction for Barrier Codes or Lines/Trunks	Outward-Restricted
Maintenance/Programming Barrier Code	In Release 3.0 and later systems, there is no default barrier code. In Release 2.1 and earlier systems, the default barrier code is 16.
Redirect Destination for Calls to Unassigned Numbers	Primary Operator
Remote Access Code	889



SECURITY ALERT:

Security of Your System. *As a customer of a new communications system, you should be aware that telephone toll fraud is an increasing problem. Telephone toll fraud can occur in many forms, despite the numerous efforts of telephone companies and telephone equipment manufacturers to control it. Some individuals use electronic devices to prevent or falsify records of these calls. Others charge calls to someone else's number by illegally using lost or stolen calling cards, billing innocent parties, clipping on to someone else's line, and breaking into someone else's telephone equipment physically or electronically. In certain instances, unauthorized individuals make connections to the telephone network through the use of remote access features.*

The Remote Access feature of your system, if you choose to use it, permits off-premises callers to access the system from a remote telephone by using an 800 number or a 7- or 10-digit telephone number. The system returns an acknowledgment signaling you to key in your barrier code, which is selected and programmed by the system manager. After the barrier code is accepted, the system returns a dial tone to you. If restrictions are not in place, you can place any call normally dialed from a telephone within the system. Such an off-premises network call is originated at, and will be billed from, the system location.

The Remote Access feature, as designed, helps the customer, through proper programming, to minimize the ability of unauthorized persons to gain access to the network. Most commonly, telephone numbers and codes are compromised when overheard in a public location, through theft of a wallet or purse containing access information, or through carelessness (writing codes on a piece of paper and improperly discarding it). Additionally, hackers may use a computer to dial an access code and then publish the information to other hackers. Enormous charges can be run up quickly. It is the customer's responsibility to take the appropriate steps to properly implement the features, evaluate and program the various restriction levels,

protect access codes, and distribute access codes only to individuals who have been fully advised of the sensitive nature of the access information.

Common carriers are required by law to collect their tariffed charges. If these charges are fraudulent charges made by persons with criminal intent, applicable tariffs state that the customer of record is responsible for payment of all long-distance or other network charges. Lucent Technologies cannot be responsible for such charges and will not make any allowance or give any credit for charges that result from unauthorized access.

To minimize the risk of unauthorized access to your communications system:

- *Program the maximum length (11) for systemwide barrier code length (Release 3.0 and later).*
- *Use an unpublished remote access number.*
- *Assign barrier codes randomly to users on a need-to-have basis, keeping a log of all authorized users and assigning one code to one person.*
- *Use random-sequence barrier codes, which are less likely to be easily broken.*
- *Deactivate all unassigned codes promptly.*
- *Ensure that remote access users are aware of their responsibility to keep the telephone number and any barrier codes secure.*
- *When possible, restrict the off-network capability of off-premises callers, through use of calling restrictions and Disallowed List features.*
- *When possible, block out-of-hours calling.*
- *Frequently monitor system call detail reports for quicker detection of any unauthorized or abnormal calling patterns.*
- *Limit Remote Call Forwarding to persons on a need-to-have basis.*
- *Change barrier codes periodically.*

Beginning with Release 3.0, additional security to prevent telephone toll fraud is included:

- *The remote access default requires a barrier code.*
- *The barrier code is a flexible-length code ranging from 4 to 11 digits (with a default of 7) and includes the * character. The length is set systemwide.*
- *The user is given three attempts to enter the correct barrier code.*

- *Whether or not the dialed digits are correct, an inter-digit time-out occurs during the first attempt. The system processes only the valid number of digits. So if a hacker enters four digits and the length is four digits, he or she hears dial tone. If a hacker enters four digits and keeps entering more, the system uses the time-out to hide the correct number of digits from the hacker. The time-out recurs until the caller has dialed the eleventh digit—giving the impression that additional digits are required—even if the barrier code length is shorter.*
- *SMDR registers 16 zeros for any remote access calls in which three failed attempts have occurred.*

Description

The Remote Access feature allows people to use the system by dialing the number of a line/trunk designated for remote access. The remote user should be required to dial a barrier code (password) after reaching the system. Beginning with Release 3.0, the systemwide barrier code length is programmed for a minimum of 4 digits and a maximum of 11. After gaining access to the system, a remote user can do any of the following:

- Dial extension numbers directly without going through a system operator. Remote callers can call inside extensions, data workstations, or calling groups just as if they were calling from an extension within the system.
- Select a regular or special-purpose outside line (for example, a WATS line) or a pool or ARS line to make outgoing calls. If the pool is busy, the system can be programmed to allow the remote user to use Callback to queue a call for the busy pool.
- Arrange to have calls forwarded, change the forwarding destination, or cancel forwarding to a telephone inside or outside the system.



NOTES:

- Calls made through remote access to locations outside the system may vary in transmission quality.
- In Release 6.0 and later systems, a remote access caller who calls into his or her own local system can reach extensions networked to the local system (non-local dial plan extensions), just as onsite users of the local system can.
- In Release 6.0 and later systems (Hybrid/PBX mode only), ARS calls that use public-switched network trunks connected to remote networked systems are treated as remote access calls at the remote system and at any intervening systems. For details, see [“Tandem Switching”](#). Full details about private networks are provided in the *Network Reference*.

Remote access also allows remote system programming and maintenance.

Specific outside lines/trunks (ground-start, loop-start, emulated ground-start or loop-start) are programmed for either dedicated or shared remote access. When dedicated remote access is programmed for a line/trunk, all incoming calls on that line/trunk are treated as remote access calls. When shared remote access is programmed for a line/trunk, incoming calls on that line/trunk are treated as remote access calls only when Night Service is activated on the system. Remote access can be assigned in this way to any outside line connected to the system, except Direct Inward Dial (DID) trunks, PRI dial-plan routed facilities, or dial-in tie trunks. Loop-start lines programmed for remote access should also be programmed for reliable disconnect and must provide reliable disconnect.



SECURITY ALERT:

Avoid programming a remote access line as a destination for Night Service on any published telephone number. Professional toll-fraud criminals scan telephone directories for published local and 800 telephone numbers. Using these numbers, they attempt to gain access to the system, then may use such features as Remote Access to reach outside facilities from within the system. For additional information about toll fraud, see [Appendix A, "Customer Support Information."](#)

For DID trunks and PRI dial-plan routed facilities, the routing digits must correspond to the remote access code programmed into the dial plan. In Release 6.0 and later systems, non-local remote access codes can be programmed into a system's non-local dial plan. Barrier codes should be required for tandem trunks; this is particularly important in Release 6.0 and later systems (Hybrid/PBX mode) that are networked. For dial-in tie trunks, remote access is possible when the remote user dials the remote access code (the factory-set code is 889).

When a person calls into the system on a line/trunk that is programmed for remote access, the system answers the call and the caller receives a special dial tone. If a barrier code is not required, the caller can dial an extension, pool dial-out code, ARS code, telephone number, or feature code. If a barrier code is required, the caller dials the required 4- to 11-digit barrier code and receives a second dial tone.



NOTE:

To activate features when using remote access, press * followed by the feature code. Pressing # followed by the feature code (as on a single-line telephone) does not work.

Lines and Trunks

Remote access calls are treated differently, depending on the type of line/trunk and how it is routed.

- **Line.** Loop-start, ground-start, emulated loop-start, emulated ground-start, BRI, and PRI B-channels programmed for line-appearance routing can be set for remote access use, dedicated or shared. A remote access caller does not dial the remote access code when remote access is in effect on these lines/trunks.
- **Dial-In Tie.** This type of line/trunk requires the caller to enter the remote access code when dial tone is received. The code is not part of the telephone number.
- **Local Dial Plan.** If a remote access caller dials the system on a DID, E&M, PRI B-channel with dial-plan routing, T1-emulated tie line, or T1-emulated DID trunk, the caller can be connected without entering the remote access code separately. Instead, the remote access code is part of the telephone number dialed by the caller and is routed automatically by the system as a remote access call. If the dialed telephone number does not include the remote access number or the line/trunk is not programmed for routing by dial plan, the call is treated as a normal incoming call and remote access is not available.
- **Non-Local Dial Plan** (Release 6.0 and later systems, Hybrid/PBX mode). Intersystem calls between extensions on networked systems are not remote access calls. The remote access code for a non-local system, however, can be included in the non-local dial plan, so that users from one system can reach another networked system more economically via remote access for changing forwarding or for system maintenance. The remote access codes of networked systems must be unique and unambiguous with respect to the other numbers in the local and non-local plans. The receiving system applies restrictions, and barrier codes should be required.

When a call is received for an unassigned number on a dial plan-routed PRI facility, a DID trunk, a dial-in tie trunk, or a line/trunk programmed for shared remote access and Night Service is activated, the call is redirected to the QCC queue, a calling group, or an extension, depending on how the destination of calls to unassigned numbers is programmed. The factory setting specifies the primary operator as the destination.

When a call is received for an unassigned number on a private network facility, the caller hears a fast busy or warble tone, depending on the type of facility, on which the call arrived.



NOTE:

In Release 6.0 and later systems (Hybrid/PBX mode), a remote access user from one system can reach Remote Access on a networked remote system by using a DID trunk, tandem trunk, a PRI B-channel with dial-plan routing, T1-emulated DID trunk, or dial-in tie trunk. The remote system applies any restrictions. The remote access codes for each system must be unique and unambiguous. The default COR settings that control this access should require barrier codes.

[Table 39](#) summarizes the ways that remote access is made available to callers, depending upon the type of line/trunk and the routing used on that line/trunk.

Table 39. Remote Access Routing

Routing	Facility	User Dials	Facility Remote Access Programming
Line	Loop-start, ground-start, emulated loop- or ground-start, BRI, PRI B-channel group programmed for line routing, automatic-in tie, emulated automatic-in tie	Telephone number	Must be programmed for dedicated or shared remote access.
Not routed	Dial-in tie or emulated dial-in tie	Remote access code	Tie default COR settings
Dial-Plan	DID or emulated DID, PRI B-channel group programmed for dial-plan routing	Telephone number including remote access code	System must be programmed to add or delete digits to or from dialed telephone numbers received, so that the remote access code is received. Non-tie default COR settings, including barrier code requirement, apply. In networked Release 6.0 and later systems particularly, a barrier code should be required.

Table 39. Remote Access Routing — Continued

Routing	Facility	User Dials	Facility Remote Access Programming
Non-local dial plan	PRI tandem trunk; T1-emulated tie, T1-emulated voice tie, or analog tie line	Programmed extension number specifying non-local remote access code	Default COR settings for tie and/or non-tie trunks as applicable, including barrier code requirement, apply. A barrier code must be required. Restrictions are then the ones associated with each barrier code and not the ones assigned to the default COR.
Tandem	UDP-routed PRI tandem trunk; tandem T1-emulated data tie, T1-emulated voice tie, or analog tie line	ARS access code for remote system or non-local dial plan number, plus telephone number	Remove COR outward restrictions from tie and/or non-tie trunks as applicable. Barrier code required or not required setting is ignored (should be required), but Disallowed List is applied. FRL for default COR setting is applied to any routing of the call out of the local system ARS access code or non-local dial plan number.

For more information, see [“Primary Rate Interface \(PRI\) and T1” on page 509](#). [“Tandem Switching” on page 699](#) provides additional information about default COR settings for networked systems (Release 6.0 and later, Hybrid/PBX mode), as does the *Network Reference*.

User Interaction

Beginning with Release 3.0, a caller has three chances to enter the correct barrier code. An inter-digit time-out occurs during the first attempt, even if the dialed digits are incorrect. The system only processes the valid number of digits. A dial tone is given after the correct code is entered. If the caller enters more than the correct number of digits, the system uses the time-out to hide the correct number of digits. The time-out recurs until the caller has dialed the eleventh digit—giving the impression that additional digits are required—even if the barrier code length is shorter. A distinctive tone sounds after an incorrect entry. After three incorrect entries, the system disconnects the caller.



NOTE:

The steps below describe a normal remote access call. In Release 6.0 and later systems, an ARS remote access call is dialed just as any other ARS call is dialed. Calls made by remote access users, rather than users on networked external systems, are dialed as described below.

The following steps describe a remote access call:

1. The caller dials into a line, described above, that accepts remote access calls. Personal lines light steady green.
2. If a barrier code is not required, the caller hears a dial tone and proceeds to Step 4.
3. If a barrier code is required, the caller dials the code.

A barrier code cannot begin with * (star) or contain two *s:

- a. If a correct barrier code is entered, the caller hears a dial tone and proceeds to Step 4. If an incorrect barrier code is entered, the caller hears an alternating high-low tone followed by a dial tone, and can enter the barrier code again. Up to three attempts are allowed.
 - b. If the caller enters an incorrect barrier code, he or she hears a retry tone 15 seconds after the system determines that the code is invalid. During this step, the caller can enter two asterisks (**) to erase the entry. This is treated as a failed attempt. The system then erases the code entry and sends a retry tone for another attempt at entering the barrier code (unless this was the caller's third attempt). If the caller fails all three attempts at entering the code, he or she hears the reorder dial tone and is eventually disconnected by the system.
4. After successfully entering a barrier code, the caller may now enter a telephone number, pool number, ARS code, or maintenance code.

Class of Restrictions (COR)

Barrier codes should be used for all lines/trunks including those that will be accessed by remote access users in Release 6.0 and later systems (Hybrid/PBX mode only). ARS calls and non-local dial plan calls on private network trunks ignore the barrier code requirement setting, but use the other COR settings assigned to all tie and/or all non-tie trunks. The barrier code requirement setting must require barrier codes, however, to protect against toll fraud for those calls from the PSTN that do not ignore the requirement.

A maximum of 16 barrier codes is allowed, each with a different class of restrictions. The class of restrictions allows or denies the use of system features to individuals or groups of users. Classes of restrictions are assigned whether or not barrier codes are used for remote access. If barrier codes are used, the class

of restriction is assigned to each barrier code. If barrier codes are not used, the class of restriction settings are assigned to all non-tie trunks or to all tie trunks, or both. They apply to trunks that are not specifically assigned as remote access facilities, as explained in [Table 39 on page 608](#).

The restriction classes are as follows:

- **Calling Restrictions.** Determine whether remote access users can make local and/or toll calls. The factory setting is outward-restricted, meaning the user can make only inside calls. The restricted user cannot make toll calls or any outside calls. The setting can be changed either to unrestricted, meaning the user can make inside local, toll, or outside calls, or to toll-restricted, meaning the user can make only inside and local outside calls. When barrier codes are not used, restrictions are assigned to all trunks and cannot be assigned to individual tie trunk or non-tie trunks. When barrier codes are used, restrictions are assigned to individual barrier codes. For routing calls on tandem trunks across networked Release 6.0 and later systems (Hybrid/PBX mode), the outward restriction must be turned off. For additional details, see [“Tandem Switching” on page 699](#). Outward restrictions can still be applied to barrier codes that are used when callers employ PRI dial-plan routed, DID, or non-local dial plan remote access.
- **Automatic Route Selection and Uniform Dial Plan (UDP) Facility Restriction Level (FRL).** If the system uses the ARS feature or UDP routing over tandem trunks (Release 6.0 and later systems, Hybrid/PBX mode), you can restrict the use of outgoing lines/trunks by remote access users by assigning a user restriction level from 0 to 6. The factory setting, 0, is the most restrictive, and 6 is the least restrictive. The value assigned corresponds inversely to the FRL assigned to the ARS or UDP route (Release 6.0 and later systems). That is, an FRL of 0 is the least restrictive, and 6 is the most restrictive. To restrict remote users from using selected lines/trunks, you should assign a value that is lower than the FRL assigned to the route.

When barrier codes are not used, the FRL is assigned to all remote access lines/trunks and cannot be assigned to individual lines/trunks. When barrier codes are used, FRLs are assigned to individual barrier codes, and this setting is ignored. For networked Release 6.0 and later systems (Hybrid/PBX mode), barrier codes should be required; they are then required for non-network calls into these systems via the public switched telephone network or via the remote access code in the non-local dial plan. Network call routes (UDP or ARS) use the default COR FRL and do not use barrier codes. For additional details, see [“Tandem Switching” on page 699](#).
- **Allowed List Assignment.** Does not apply to Allowed List Assignment. Do *not* assign Allowed Lists as default COR settings.

- **Disallowed List Assignment.** Assigns Disallowed Lists; use when remote access users are not restricted from making local and/or toll calls. When a Disallowed List is assigned, remote users cannot dial the specific numbers included on the list. Disallowed Lists are set up for all system users (see [“Allowed/Disallowed Lists” on page 42](#)). When barrier codes are not used, Disallowed Lists can be assigned to all remote access lines/trunks and cannot be assigned to individual lines/trunks. When barrier codes are used, Disallowed Lists are assigned to individual barrier codes. For networked Release 6.0 and later systems (Hybrid/PBX mode), a Disallowed List should be assigned; it is applied both to non-network calls into these systems via the public switched telephone network and to network-routed calls. For additional details, see [“Tandem Switching” on page 699](#).
- **Automatic Callback (Autoqueueing).** The factory setting prevents a remote caller who reaches a busy pool (Hybrid/PBX only) or extension from using the Automatic Callback feature to request a pool or extension. The factory setting can be changed to allow remote users to use Automatic Callback to request busy pools or extensions. Automatic Callback assignment applies to all remote access users and cannot be assigned to lines/trunks or barrier codes on an individual basis. For networked Release 6.0 and later systems (Hybrid/PBX mode), the Automatic Callback setting does not apply to network calls that are routed across a system using ARS or UDP routing. Callback features only work for lines and trunks on a local system. If a remote access caller calls into a system and attempts to make a non-local extension call or an ARS call that is routed to another networked system, the Callback setting only permits or does not permit Callback when local tandem trunks are unavailable; calls queue for Route 1 only. For additional details, see [“Tandem Switching” on page 699](#).

Considerations and Constraints

Under applicable tariffs, the customer is responsible for any charges incurred through the remote use of system facilities. To prevent unauthorized use of the system's outside lines by remote callers, see the Security Alert on [page 603](#).

Beginning with Release 3.0, combining mismatched line/trunk types (touch-tone and rotary) does not cause a call to fail.

Rotary-dial telephone users are routed to a QCC assigned as a backup extension. From there, callers are connected to the system operator.

Remote access calls ring on SA or ICOM buttons; however, the telephone rings like an outside call.

Systems with DID trunks can designate a DID extension that offsite users can dial to use remote access.

If a remote caller does not dial a number or feature code before the time-out period expires, the call goes to the redirect destination programmed for remote access.

Lines/trunks used for dedicated remote access must not be assigned to ring into a calling group.

Systems that use Call Accounting System (CAS) track calls by barrier codes.

Touch-tone receivers are needed for remote access to work. For more information about TTR requirements see [“Touch-Tone or Rotary Signaling” on page 716](#).

In Release 6.0 and later systems, a remote-access caller who calls into his or her own local system can reach extensions networked to the local system (non-local dial plan extensions), just as onsite users of the local system can.

Mode Differences

Hybrid/PBX Mode

Remote access Automatic Callback is available only in Hybrid/PBX mode for calls made to busy pools.

In Release 6.0 and later systems, networked trunks for use by non-local dial plan extensions connected to another MERLIN LEGEND Communications System or to a DEFINITY ECS or DEFINITY ProLogix Solutions systems are available only in Hybrid/PBX mode.

Feature Interactions

Account Code Entry A remote access user cannot enter account codes. If a remote access user, however, calls an inside extension and the person at that extension enters an account code, the code overwrites the barrier code number (01–16) in the ACCOUNT field of the SMDR report.

Allowed/Disallowed Lists Allowed and Disallowed Lists are COR items for remote access. When barrier codes are not used, Allowed and/or Disallowed Lists can be assigned to lines/trunks systemwide (tie trunks and non-tie trunks are grouped separately). When barrier codes are used, Allowed and/or Disallowed Lists can be assigned to individual barrier codes.

Do not assign any Allowed List to a remote access barrier code or to the default COR for all tie and/or non-tie trunks. When used in conjunction with toll and local restrictions applied to the barrier code or COR, Allowed Lists do not work.

**Allowed/
Disallowed Lists**

In Release 6.0 and later systems (Hybrid/PBX mode only), for private trunks that will be used by remote networked users to access network trunks via ARS, default COR programming is used. Disallowed Lists should be programmed appropriately (all tie and/or all non-tie) for these trunks. Allowed Lists should not be used.

Authorization Code

A caller cannot enter an authorization code on a remote access call.

**Automatic Route
Selection**

Remote access users can make calls by using ARS. They dial into the system, enter a barrier code if one is required, and dial the ARS code while listening to system dial tone. FRLs can be assigned to restrict the routes that remote callers can use. When barrier codes are not used, an FRL is assigned to all lines/trunks (tie trunks and non-tie trunks are grouped separately) and cannot be assigned to individual lines/trunks. When barrier codes are used, FRLs are assigned to individual barrier codes.

The steps above are not used by networked non-local users making ARS calls into your system, even though your system treats these calls as remote access calls. Instead, a caller dials the ARS call just as they would any other ARS call.

Callback

If the system is programmed for remote access, remote access users can use Callback. (The factory setting for Automatic Callback is off, but you can enable this feature in Hybrid/PBX mode only for remote access callers.) The user cannot hang up, but must wait on the line until the extension or pool is available.

Caller ID

Calling Party Number is not retrieved on remote access lines/trunks unless LS-ID Delay is programmed for the line/trunk, because the calls are answered too quickly.

Conference

An inside user can initiate a conference with the callers involved in a remote access call by selecting the active remote access line/trunk.

Digital Data Calls

Data calls cannot be made into lines programmed for remote access.

Display

Calls received through remote access show standard call information for outside calls, including the caller's number if an ISDN service or Caller ID is available. If you have Caller ID service and a Release 7.0 or later system, the caller's name also can be viewed. If a remote access call is sent to coverage because an invalid number has been dialed, an MLX or ETR display telephone user who receives the call sees *Cover DISA#?* on Page 1. Page 2 of the display shows the Calling Party Number or Calling Party Name.

**Forward and
Follow Me**

You can set up forwarding of calls to extensions or outside telephone numbers through remote access, as long as the system manager has enabled Remote Call Forwarding. To do so, call into the system on a line/trunk that is programmed for remote access. If a barrier code is required, the remote access dial tone (stutter tone) sounds. Enter the barrier code. Once you have correctly entered the barrier code (or if barrier codes are not required), the system dial tone sounds.

Forward and Follow Me (continued)

To forward calls to an extension, dial *33 while listening to system dial tone. Then dial the forwarding extension number and the destination extension number.

To forward calls to an outside telephone number, dial *33 and the forwarding extension number. Then dial either the ARS or pool dial-out code (Hybrid/PBX mode only), the line/trunk number (usually 801–880), or a * for Centrex Transfer via Remote Call Forwarding (Release 6.0 and later systems). Finally, dial the destination telephone number and press # to signal the end of the dialing sequence. If a Pause is needed in the dialing sequence for Centrex Transfer via Remote Call Forwarding, the feature must be activated at a local system multiline extension.

To cancel forwarding of calls to an extension, dial *33 while listening to system dial tone. Then dial the forwarding extension number.

Group Calling

A remote access user cannot be a member of a calling group, but can call into a calling group. When the call rings at a calling group member's telephone, it rings as an outside call. A calling group can be programmed to receive calls that remote access users make to invalid extensions. If a line/trunk is programmed for both remote access and Group Calling, remote access overrides Group Calling.

In Release 6.0 and later systems, remote access calls to a calling group are not subject to queue control.

Music-On-Hold

Remote access users waiting for a busy pool or extension do not hear Music-On-Hold, even if it is programmed on the system. They hear the queuing tone, then silence.

Night Service

In Release 4.1 and later systems, the outside line/trunk can be assigned to a Night Service group; in this case, incoming calls received on the outside line/trunk receive remote access treatment when Night Service is activated at any system operator position for a group where the line is assigned. In Release 4.0 and prior systems, when incoming calls are received on a line/trunk programmed for shared remote access, they are treated as remote access calls only when Night Service is activated on *all* of the operator positions that receive calls on that line/trunk.

When a call is received on a line/trunk programmed for shared remote access and Night Service is not activated, the call rings at the extension programmed as the redirect destination for calls to invalid numbers.

Paging

Loudspeaker paging cannot be accessed from outside the system through DID lines or remote access.

Primary Rate Interface and T1 Service Observing

A PRI line that has been programmed for routing by dial plan should not be programmed for remote access.

In Release 6.1 and later systems, Service Observers can observe a Remote Access call if it is answered at an extension on the local system. Remote Access cannot be used to activate Service Observing.

- SMDR**
- Remote access calls are recorded only if SMDR is programmed to track incoming calls. If a barrier code is entered, the barrier code number (01–16) appears in the ACCOUNT field of the report, preceded by 999999. If the caller uses remote access to dial an extension and the call is answered, the extension number is shown in the STN (station) field. If the call is not answered at the extension, the STN field is blank.
- If the caller uses remote access to dial out on a line or trunk, the STN field on the first SMDR record is blank and a second record is generated for the outgoing call.
- If no barrier code is required, the ACCOUNT field contains 99999900.
- In Release 3.0 and later systems, if a caller provides an invalid or incomplete barrier code for three attempts, either 999999 or 16 zeros are recorded in the ACCOUNT field. If the connection is broken before the third attempt, the ACCOUNT field contains 999999. If a caller hangs up after the third attempt but before receiving reorder tone, the ACCOUNT field may contain either 999999 or 16 zeros. If a caller hangs up after the third attempt and after receiving reorder tone, the ACCOUNT field contains 16 zeros.
- System Renumbering**
- If the system includes DID or dial-in tie trunks, the number assigned to the line/trunk can be programmed for remote access. This allows remote access users to call in on the DID or dial-in trunk.
- The remote access code can be renumbered. The factory-set remote access code is 889.
- Tandem Switching**
- Remote access allows non-local network users to access trunks connected to the public switched telephone network, permitting cost savings. Barrier codes are not used for this application of tandem trunks. Instead, default tie and/or non-tie COR permissions and restrictions are used, depending on whether private network trunks are tie trunks or PRI facilities.
- A caller can reach remote access on a networked system by calling in on DID, PRI dial-plan routed, or dial-in tie trunks or by dialing a remote access code programmed into the non-local dial plan. The remote system applies any required restrictions. The barrier code requirement for the default COR should be turned on.
- Uniform Dial Plan**
- A remote access caller can call a number in the non-local dial plan.

Features

Ringling Line Preference

617

Ringling Line Preference

See [“Automatic Line Selection and Ringling/Idle Line Preference”](#) on page 69.

Ringling Options

At a Glance

Users Affected	Telephone users, DLC operators
Reports Affected	Extension Information, System Information (SysSet-up)
Modes	All
Telephones	All except QCC
Programming Codes	(centralized telephone programming only for single-line telephones and MFMs)
Ring Timing Options	
All personal line and Pool buttons on extension	*347
Immediate Ring	*346
Delay Ring	*345
No Ring	
Individual personal line, Pool, SA, ICOM, and Cover buttons	*37
Immediate Ring	*36
Delay Ring	*35
No Ring	
Send Ring (on principal extension, for Shared SA buttons with Delay Ring)	
On	*15
Off	**15
Abbreviated Ring (multiline telephones only)	
On	*341
Off	*342
Personalized Ringing (multiline telephones only)	*32 + ringing pattern number (1-8)
MLX Display Labels	RingOptions, All Lines, Immed Ring/Delay Ring/No Ring RngOp, AllLn, Immed/Delay/No RingOptions, One Line, Immed Ring/Delay Ring/No Ring RngOp, 1Line, Immed/Delay/No SharedSARng, On/Off [ShRng, On/Off] RingOptions, Abbreviated, On/Off [RngOp, Abbrv, On/Off] PersonalRng, Pattern #n [PRing, Pat#n]
System Programming	To set delay for Cover buttons programmed for Delay Ring (Delay Ring Interval, 4.0 and prior systems) ■ Options→Delay Ring

Factory Settings	
Ring Timing Option (all buttons)	Immediate Ring
Delay Ring Interval	2 rings (range 1–6 rings)
Send Ring	On
Abbreviated Ring	Enabled
Personalized Ringing Pattern	1 (pattern numbers 1–8)

Description

Ringing Options refers collectively to three options that determine how users' telephones ring when they receive calls: Ring Timing options, Abbreviated Ring options, and Personalized Ringing options. These options are programmed for each extension through either extension programming or centralized telephone programming, using the display or programming codes. In addition, the system uses distinctive ringing patterns to identify various call types to the telephone user.

Ring Timing Options

Ring Timing options control how soon a telephone rings, or whether it rings at all when a call arrives. Line buttons on each extension can be programmed so that calls ring as follows:

- **Immediate Ring** (factory setting). Rings as soon as a call arrives.
- **Delay Ring**. Provides a delay before the telephone rings. The length of the delay depends on the type of button and the coverage arrangement:
 - On outside line, SA (including Shared SA), and ICOM buttons programmed for Delay Ring, the delay is fixed at two rings and cannot be changed.
 - On Cover buttons programmed for Delay Ring in Release 4.0 and prior systems, the systemwide Delay Ring Interval, set through system programming, provides a delay of one to six rings with a factory setting of 2.

In Release 4.1 and later systems, system managers customize coverage delays on an extension-by-extension basis. The Coverage Delay Interval and Delay Ring Interval systemwide settings are replaced by these extension timers: Primary Cover Ring Delay and Secondary Cover Ring Delay (range 1–6 rings, factory setting 2 rings).
 - In Release 4.1 and later systems, the Group Coverage Ring Delay (range 1–9 rings, factory setting 3 rings) is set for each sender's extension. When a sender has both Individual and Group Coverage, the Primary Cover Ring Delay controls the interaction between the two types of coverage.

In Release 4.0 and prior systems, when a sender has both Individual and Group Coverage and an Individual Coverage receiver is available, the programmed systemwide Delay Ring Interval of one to six rings provides a delay, in addition to the systemwide Coverage Delay Interval, before calls go to Group Coverage.

- **No Ring.** Prevents the telephone from ringing at all. However, the distinctive returning transfer and callback rings, described later in this section under [“Distinctive Ringing” on page 621](#), do sound.
- **Send Ring.** An additional Ring Timing option, used at the principal extension to override Delay Ring programming for any Shared SA buttons. If a call arrives at the principal extension’s SA button and that extension is busy on another call, the call rings immediately at the SSA buttons programmed for Delay Ring.

Ring Timing options can be programmed *individually* for each personal line, prime line, Pool, SA (including Shared SA) or ICOM, and Cover button on an extension. The extension also can be programmed so that all *outside* calls on personal line, prime line, and Pool buttons ring uniformly with one of these timing options. (SA, ICOM, and Cover buttons must always be programmed individually.)

Regardless of the Ring Timing option selected, the green LED next to the line button with a call flashes immediately when a call arrives.

**NOTES:**

- Ring Timing options cannot be programmed for SA Originate Only or ICOM Originate Only buttons because they do not ordinarily receive calls.
- For more information about coverage ring delays, see [“Coverage” on page 170](#).

Abbreviated Ring Options

The Abbreviated Ring setting specifies how a telephone rings if a call arrives when a user is already on another call. Each extension can be programmed to ring in one of the following ways:

- **Abbreviated Ring** (factory setting). When the user is already on a call, a new call arriving on a line button programmed for Immediate Ring or Delay Ring rings only once. The ring is at a lower volume (called *attenuated ring*) than the normal ring.
- **Repeated Ring.** The telephone rings normally. When the user is already on a call, an incoming call continues to ring until it is answered.

Personalized Ringing Options

Personalized Ringing options allow a user to select one of eight different ringing patterns for his or her telephone, making it easier to distinguish its ring from those of other telephones. The user hears the personalized ringing pattern as the long part of the distinctive ring that identifies an inside, outside, returning transfer, or callback call, described in the next section. Pattern #1 is the factory setting.

Distinctive Ringing

Distinctive ringing allows users to identify the type or origin of an incoming call. The system identifies calls with the distinctive ringing patterns listed in [Table 40](#). These patterns cannot be changed.

Table 40. Distinctive Ringing

Call Type...	Telephone Type...			
	MLX ¹	ETR, MLS, or Analog Multiline ¹	Single-Line	QCC
Inside	1 long ring	1 long ring	1 ring	1 ring
Outside	1 long ring + 1 short ring	1 short ring + 1 long ring	2 rings	2 rings
Transferred outside call or returning transfer	1 long ring + 2 short rings	2 short rings + 1 long ring	3 short rings	1 ring
Returning callback call (priority ring)	1 long ring + 3 short rings	2 short rings + 1 long ring	3 short rings	

¹ Includes Direct-Line Consoles.



NOTE:

The long ring is the personalized ringing pattern selected for the telephone.

Considerations and Constraints

Transfer returns ring repeatedly until answered, regardless of the Abbreviated Ring setting for the telephone.

When one of the eight personalized ringing patterns is selected, through either extension programming or centralized telephone programming, the person programming the option hears the ring selected. In Release 2.0 and later systems, an MLX display telephone user *must* select **Enter** from the display to confirm and store the selection. After choosing **Enter**, the user again hears the selected ring.

The personalized ringing pattern selected for each extension is not shown on system programming reports.

Delay Ring is especially useful on a Cover button because it gives the sender a chance to answer before the call rings at the receiver's telephone. No Ring is appropriate for users who do not usually answer outside calls. To answer a call when a telephone is programmed not to ring, simply press the line button with the flashing green LED.

While using programming codes or display selections to program Ring Timing options for one line, press a line to which these options apply—any line button with an outside line or any SA or ICOM button. If you press any other type of button, an error tone sounds; at a display telephone, you also see an error message. While programming Ring Timing options for all outside lines, you can press *any* line button, not necessarily an outside line button.

Telephone Differences

Queued Call Consoles

Ringing options cannot be programmed on a QCC. The Call buttons are fixed to Immediate Ring. A QCC receives only two types of distinctive ringing—one ring for an inside call and two rings for an outside call.

Other Multiline Telephones

Personalized ringing can be programmed for an MLC-5 cordless telephone only through centralized telephone programming.

Personalized ringing is not supported on MDC 9000 telephones.

Ring Timing Options can be programmed for a Multi-Function Module (MFM) only through centralized telephone programming.

If you set the ringer volume to low (about one-third of the maximum level) on an ETR or MLS telephone, you may not hear abbreviated ringing. Adjust the volume level as needed.

Single-Line Telephones

Neither abbreviated ringing nor personalized ringing can be programmed for single-line telephones. Ring Timing options can be programmed only through centralized telephone programming.

Single-line telephones connected to a 008 OPT module do not receive distinctive ringing for the various call types listed in [Table 40 on page 621](#).

Feature Interactions

- Auto Answer All** A General Purpose Adapter (GPA) connected to an analog multiline telephone answers calls on lines set for Immediate or Delay Ring. Program lines that are not to be answered for No Ring. If the device should answer only inside calls, Personal Lines must be set for No Ring.
- Automatic Line Selection** The system does not automatically select outside line, SA, ICOM, or Cover buttons programmed for No Ring, even when Ringing/Idle Line Preference is turned on. The user must select the button manually to answer a call. The green LED flashes when the call arrives; when the user presses the button, the red LED turns on.
- Caller ID** The Delay Ring option can be used as an alternative to the LS-ID Delay option at automatically answering adjuncts so that Caller ID information is received. LS-ID Delay delays ringing at all extensions in the system, while Delay Ring delays ringing only at the extension programmed for it. Delay Ring timing starts when LS-ID Delay ends.
- Coverage** Primary Cover, Secondary Cover, and Group Cover buttons can be programmed for Immediate Ring, Delay Ring, or No Ring.
- Calls received on line buttons programmed for No Ring are not sent to coverage.
- If an Individual or Group Coverage receiver is on a call when a coverage call is received, the receiver hears an abbreviated ring (if enabled).
- Calls received on a Primary Cover, Secondary Cover, or Group Cover button use the receiver's, not the sender's, personalized ringing pattern.
- In Release 4.1 and later systems, the ringing at a programmed Primary or Secondary Cover button, set for Delay Ring, is augmented by the Primary and Secondary Ring Delays set for the sender's extension. The systemwide Secondary Ring Delay Interval, fixed at two rings, also augments ringing on Secondary Cover buttons set for Delay Ring. For more information, see ["Coverage" on page 170](#).
- In addition to its primary function, the Delay Ring Interval in Release 4.0 and prior systems provides a delay before calls go to Group Coverage, in addition to the Coverage Delay Interval, when the sender also has Individual Coverage and a receiver is available.
- Digital Data Calls** Personalized ringing has no effect on calls to a digital communications device.
- Terminal adapters follow programmed ringing options and should be set to Immediate Ring.
- Videoconferencing systems are not affected by ringing options.

Fax Extension

The Fax Extension feature overrides the distinctive ringing pattern for calls transferred to a fax extension. When a fax extension receives a transferred call, the fax extension provides one long ring (similar to an inside call) instead of three short rings.

Forward and Follow Me

On multiline or single-line telephones where an SA or ICOM button is available to receive the call, calls forwarded to an extension ring with an abbreviated ring at both the forwarding extension and the destination extension. Calls forwarded from either a multiline or single-line telephone to an outside telephone number do not ring at the forwarding extension. In Release 4.0 and prior systems, if no SA or ICOM button is available at the forwarding extension, the call is not forwarded and the caller hears a busy tone.

In Release 4.1 and later systems, a forwarded call that is received when the forwarding single-line or multiline telephone has no available SA or ICOM button is forwarded immediately and does not ring at the forwarding extension, regardless of the Ring Timing options (Delay, Immediate, or No Ring) set.

Outside calls received at the forwarding extension ring as inside calls at the destination extension (one ring) and do not receive the normal distinctive ring for an outside call.

With Immediate Ring, calls are sent immediately to the forwarded extension. With Delay Ring, calls are delayed before forwarding. With No Ring, calls are not forwarded. In Release 4.0 and later systems, if a button is set to Delay Ring, calls are forwarded after both the Delay Ring and Forwarding Delay. The two delays are cumulative.

Group Calling

Abbreviated ringing is not operable for calls to a calling group extension because a calling group member who is active on a call is considered unavailable for incoming calls. In Hybrid/PBX mode, calling group members should program SA buttons for Immediate Ring.

Headset Options

If abbreviated ringing is not programmed, the user hears a low-volume ring if another call comes in while he or she is already on a call.

HotLine

Ringing Options can be set for HotLine extension (Release 5.0 and later systems) lines. If a HotLine extension should not receive calls, its line should be set for No Ring.

Multi-Function Module

The ringing patterns for tip/ring devices connected to an MFM are those of an MLX telephone rather than a single-line telephone—one ring for inside calls, two for outside calls, and three for priority ring or transfer return. Personalized ringing patterns cannot be programmed for an MFM. Centralized telephone programming must be used to program Ring Timing options (Immediate Ring, Delay Ring, or No Ring).

Night Service

When Night Service is turned on, calls received at a Night Service group member's telephone ring immediately even if the line buttons are programmed for Delay Ring or No Ring. When Night Service is turned off, telephones return to their programmed Ring Timing options.

Features
Ringling Options

625

Reminder Service

A reminder call overrides programmed Ring Timing options (Delay Ring and No Ring) and rings with a priority ring at an SA or ICOM button.

Service Observing

In Release 6.1 and later systems, when a Service Observer is observing an extension and a call comes to the Service Observer's extension, he or she hears one ring.

The ringing options on an extension or button do not affect Service Observing.

Transfer

Transfer returns ring repeatedly until answered, regardless of the Abbreviated Ring setting for the telephone.

Saved Number Dial

At a Glance

Users Affected	Telephone users, DLC operators
Reports Affected	Extension Directory
Modes	All
Telephones	All except QCC and single-line telephones
Programming Code	*85
MLX Display Label	SaveNumDial [Save#]
Maximums	16 digits

Description

Saved Number Dial allows a user to save the last number dialed from a multiline telephone and to call the number again without manually redialing. You can save the number even if the called party answers. The saved number is any extension or telephone number dialed using one of the following methods:

- Dialing the complete number on the dialpad
- Dialing the number using a Personal Speed Dial code
- Dialing the number using a programmed outside Auto Dial button
- Dialing the number using a programmed Last Number Dial or Saved Number Dial button

Saved Number Dial requires a programmed button. It does not store numbers dialed with an Extension, Personal, or System Directory, an inside Auto Dial button, a System Speed Dial code, or a DSS button.

Unlike Last Number Dial, Saved Number Dial replaces the saved number only when you press the programmed Saved Number Dial button before hanging up, not each time you dial a new number.

Considerations and Constraints

The number of Saved Number Dial buttons that can be programmed on each multiline telephone is limited only by the number of available programmable buttons.

When using Saved Number Dial on an analog multiline telephone connected to a General Purpose Adapter (GPA) in Auto mode, lift the handset before activating the feature.

Because the type of line button (personal, SA, or ICOM) used to make the call is not stored, select the appropriate line button before using Saved Number Dial to redial a number.

The green LED next to the programmed Saved Number Dial button does not go on when the feature is used.

Saved Number Dial saves whatever you dial, whether or not the number is valid.



NOTES:

- If you dial a telephone number and, after the call is connected, dial additional digits, such as an account number or password, Saved Number Dial saves all the digits, including those dialed after the call is connected (up to a total of 16).

- When you press the Saved Number Dial button, all dialed digits are shown on the display of a display telephone, including confidential information such as passwords or account codes. Therefore, you must not use Saved Number Dial with sensitive information.

If the number dialed with an outside Auto Dial button or Personal Speed Dial code includes a special character such as Pause or Stop, the special character does not work when the number is redialed by Saved Number Dial.

Mode Differences

Behind Switch

When you manually dial an outside number that includes a dial-out code—for example, an ARS or pool dial-out code required by the host system—the pauses required to wait for dial tone from some host systems are not automatically stored when Saved Number Dial is used. As a result, you may either hear a fast busy signal or reach a wrong number when you use Saved Number Dial to redial a stored number.

Key Mode

In Key mode, Saved Number Dial cannot be used on an analog multiline telephone unless a Feature button or Saved Number Dial button is programmed on the telephone. Saved Number Dial cannot be activated by pressing # and entering the feature code. The programmed Feature button must be used instead.

Telephone Differences

Queued Call Consoles

Saved Number Dial cannot be used on a QCC.

Other Multiline Telephones

On a multiline telephone, to save a number using Saved Number Dial, press the programmed Saved Number Dial button before hanging up. The green LED next to the programmed button does not go on when the feature is used.

To redial a number using Saved Number Dial, select the appropriate line for the call and press the programmed Saved Number Dial button. The number saved by the feature is dialed automatically. MLX display telephone users cannot use the feature by selecting it from the display but can use the display to program the feature onto a button.

When using Saved Number Dial on an analog multiline telephone connected to a General Purpose Adapter (GPA) in Auto mode, lift the handset before activating the feature.

Single-Line Telephones

Saved Number Dial cannot be used on single-line telephones.

Feature Interactions

Auto Dial	A number dialed by pressing a programmed outside Auto Dial button is stored for Saved Number Dial as though it were dialed with the dialpad, but special characters do not work. An extension dialed by pressing a programmed inside Auto Dial button is not stored for Saved Number Dial.
Authorization Code	For security, an authorization code is not saved by the Saved Number Dial feature. The Authorization Code feature does not affect Saved Number Dial on the extension you are using or on your home extension. You can retrieve the saved number on the telephone you are using.
Automatic Route Selection	The ARS dial-out code is saved with the telephone number dialed.
Directories	Saved Number Dial does not store numbers dialed using a Personal, Extension, or System Directory listing.
Direct Station Selector	An extension number dialed by pressing a DSS button is not stored for Saved Number Dial.

Features

Saved Number Dial

629

Display	When a user presses a programmed Saved Number Dial button, the digits appear on the display as though dialed from the dialpad.
HotLine	Saved Number Dial is not available at HotLine extensions (Release 5.0 and later systems).
Inspect	<p>In Release 2.0 and later systems, when a user presses Inspct and then a programmed Saved Number Dial button, the saved number appears on the display.</p> <p>In Release 1.0 and 1.1 systems, when a user presses Inspct and then a programmed Saved Number Dial button, <i>Saved Number Dial</i> appears on the display.</p>
Microphone Disable	When an MLX telephone's microphone is disabled, pressing a Saved Number Dial button before lifting the handset turns on the speakerphone so that you can hear the number being dialed. Once the call is answered, however, you must lift the handset to talk.
Recall/Timed Flash	Recall can be used on a call made using Saved Number Dial on a personal line or Pool button (loop-start only), an inside call, or, in Release 2.0 and later systems, an outside call made on a loop-start line using an SA or ICOM button.
Service Observing	In Release 6.1 and later systems, Saved Number Dial calls can be observed.
SMDR	All outside numbers dialed with Saved Number Dial are recorded by SMDR.
Speed Dial	Telephone numbers dialed using Personal Speed Dial are stored by Saved Number Dial. If the number includes special characters, such as Pause or Stop, the special characters do not work when the number is redialed using Saved Number Dial. Telephone numbers dialed using System Speed Dial are not stored by Saved Number Dial.
System Access/ Intercom Buttons	When Saved Number Dial is used on a call made with a Shared SA button, the number is stored on the telephone where Saved Number Dial was used, not on the principal extension.
Transfer	The Saved Number Dial feature can be used to dial the outside number of a party to which a call is being transferred.

Second Dial Tone Timer

At a Glance

Users Affected	Telephone users, operators
Reports Affected	System Information (SysSet-up)
Modes	All
Telephones	All
System Programming	<ul style="list-style-type: none"> ■ Options→More→SecDTDelay Ring→Delay Ring
MLX Display Labels	
Signal	Signal [Signl]
Notify, Send	Notify, Send [Ntfy, Send]
Notify, Receive	Notify, Receive [Ntfy, Recv]

Description

In Release 3.1 and later systems, the system manager can assign a second dial tone timer to lines and trunks. This feature helps prevent toll fraud when a company uses special services from the telephone service provider (for example, when star codes are used). Most telephone service providers offer special services that involve a second dial tone. For example, star codes enable telephone users to obtain services provided by the central office. A star code consists of a star (*) digit followed by a 2- or 3-digit number and is often dialed before an outgoing call.

After receiving certain digits dialed by a user, the central office may provide a second dial tone, prompting the user to enter more digits. If this second dial tone is delayed and the user dials digits before the central office provides the second dial tone, one of the following problems can occur:

- The central office misroutes the call. In this case, the central office misses the digits dialed before the second dial tone is provided.
- The user places a call to a restricted number, evading calling restrictions. In this case, a call that should be blocked is not because the first digit that is dialed before the central office provides second dial tone causes the dialed number not to match the restricted number.

Using the second dial tone timer, the system manager can set the time interval during which the central office is expected to provide second dial tone. Once this timer interval is exceeded, users can dial the remaining digits. If users dial the remaining digits before the timer interval is exceeded, the MERLIN LEGEND Communications System blocks the call.

Features

Second Dial Tone Timer

631

Considerations and Constraints

Contact your central office to determine whether there is a delay before second dial tone is returned. If calls are misrouted and dropped when special services requiring second dial tone are used, consider adjusting the second dial tone timer interval.

Feature Interactions

Directories and Speed Dial

Marked System Speed Dial entries (entries that do not display) are not affected by the Second Dial Tone setting. If the central office does not immediately supply dial tone when a star code is entered, and a marked System Speed Dial entry uses star codes, then the appropriate number of pauses (each 1.5 seconds) must be programmed in the entry following each star code.

Service Observing

At a Glance

Users Affected	Telephone users
Reports Affected	Service Observing, Extension Information
Modes	All
Telephones	
Service Observer Extension	MLX
Observed Extensions	All except QCC and CTI Link
Programming Codes	
Service Observing	*59 (Centralized Telephone Programming)
System Programming	
Warning Tone	Extensions→More→More→Service Observing→Warning
MLX Display Labels	Dial Ext or Press DSS Observing: 2700 Service Observing: 09

Description

In Release 6.1 and later systems, this feature allows an observer at an MLX telephone to observe calls at extensions within a Service Observing group. Observing means that the observer can hear all parties on the call but cannot talk to them.



NOTE:

Service Observing may be subject to federal, state, or local laws, rules, or regulations or require the consent of one or both of the call parties. You must check in your jurisdiction and comply with all applicable laws, rules, and regulations before using this feature. Failure to comply may result in severe penalties.

A Service Observing group can consist of any number of extensions on the local system. It can even include another Service Observer.

Any active call within the Service Observing group can be observed if it meets the following guidelines:

- An internal or external call must arrive on an SA button, Personal Line, Cover button, or Pool button.

- A call can be observed by only one Service Observer at one time
- No more than two internal parties can be on the call.

The following calls cannot be observed:

- Data call
- Video call
- Fax call
- Reminder Service call
- Page call
- Call answered by a Generic or Integrated VMI port, however, a call that is *transferred* from a Generic or Integrated VMI port (can be observed.)

To observe an extension, the observer needs only to press a programmed Service Observing button and dial either an extension number or press a DSS or Auto Intercom button number for the extension he or she wants to observe.

When the Service Observing button is pressed, the Service Observer hears inside dial tone, the green LED next to the button flashes, and the display prompts the user to enter an extension number or press a DSS button. Once the extension number has been entered or the DSS or Auto Intercom button has been pressed and an extension is successfully being observed, the LED is lit steady and the display shows the observed extension number.

Calls that can be observed appear as a steady red light at the DSS attached to the Service Observer telephone. (A steady red light next to a DSS button also can indicate that the extension has activated Do Not Disturb.) If an extension that cannot be observed is entered by the Service Observer, reorder tone sounds. Any Service Observer who attempts to observe an extension that is already being observed hears busy tone. Any Service Observer who attempts to observe an extension that already has three internal parties hears confirmation tone, which indicates that Service Observing is pending. See [Table 41](#).

Table 41. Error Tones

Observer Enters	Audible Feedback	Service Observing Active	LED	Display
Invalid Extension	Reorder	No	Off	None
Non-Extension ID	Reorder	No	Off	None
Own Extension	Reorder	No	Off	None

Table 41. Error Tones — Continued

Observer Enters	Audible Feedback	Service Observing Active	LED	Display
Valid Extension Already Observed	Busy	No	Off	None
Valid Extension 3 Internal Parties	Confirmation	Yes	Green Steady	None
Valid Extension No Active Call	Confirmation	Yes	Green Steady	None
Valid Extension	Connected	Yes	Green Steady	Service Observing xxxx:

When a Service Observer activates Service Observing for an extension that is not active on a call, as soon as a call is answered at that extension, the Service Observer's telephone goes off-hook on the speakerphone, and the Mute button turns on. If the Service Observer is using a headset, the headset automatically connects to the call at the observed extension. If the Service Observer is active on another call when a call arrives from the observed extension, no notification is given for the call from the observed extension, and the Service Observer remains on the active call.

Feature code activation is not supported since the Service Observer button is programmed by Centralized Telephone Programming. If a Service Observer wishes to change Service Observing groups or any other status of the extension, the change must be made through Centralized Telephone Programming.



NOTE:

Service Observers must be programmed through Centralized Telephone Programming to prevent random extension observing by unauthorized extensions. A Service Observing button cannot be copied.

The Service Observer is dropped from a Service Observing call if:

- The far-end extension hangs up.
- The observed extension hangs up.
- The observed extension transfers the call.
- The Service Observer hangs up.

- Another extension bridges onto the call, thus making the total of local switch extensions more than two.
- The Service Observer station uses headset hang-up.



NOTE:

When a Service Observer begins to observe an idle extension, but the extension makes or receives a call before the Service Observer's SA button times out, the Service Observer cannot observe that call unless the person at the observed extension places the call on hold and picks it up again.

Programming a Service Observing Station/Group

Programming a Service Observing button on an MLX telephone to create a Service Observer must be done through Centralized Telephone Programming. Three main programming menus are used to:

- Select and enable Service Observers.
- Turn off the warning tone option for the group (factory setting is on).



NOTE:

You may turn off the warning tone only if the local jurisdiction does not require one.

- Specify the members of the Service Observing group.

See *System Programming* for complete information about programming Service Observers and groups.

Ending a Service Observing Session

Follow these steps to end a Service Observing session:

1. Hang up the receiver.
2. Press the Service Observing button.

The LEDs next to the Service Observing button and the extension being observed turn off.

Warning Tone

The Service Observing warning tone alerts the observed extension and the other parties on the call that a Service Observer is listening in on the call. The warning tone is a single tone that occurs:

- At the beginning of each observed call.

- When the observed party takes a call off Hold.
- When the observed party conferences in another party.

For each Service Observing group that is programmed through Centralized Telephone Programming, a warning tone can be programmed to be on or off. If off is selected, no warning tone is heard, and the observed extension and the other parties on the call do not know when the call is being observed. The factory setting is on.

Considerations and Constraints

Service Observing can be performed only from an MLX telephone. Only one Service Observing button can be programmed on a telephone.

Only one extension at a time can be observed from one telephone.

Service Observing can be performed on any type of extension except an extension programmed as a QCC or CTI link. If a Service Observer extension converts to a QCC or CTI link, it is removed from the Service Observing group.

Service Observing is available on all line types.

Up to sixteen Service Observer extensions can be programmed on one system.

A Service Observer can observe another Service Observer extension if that extension is a member of the group that the first Service Observer is programmed to observe.

A Service Observer cannot observe another Service Observer who is already observing an extension.

If an extension is being observed, attempts by other Service Observers to observe the extension are denied and reorder tone sounds.

When the warning tone is set to on (the factory setting), the person at the extension being observed and the person at the far-end hear it when the Service Observer starts to listen in. If warning tone is set to off, the observed extension and the far-end receive no indication that the call is being observed.

Displays at observed extensions receive no information to indicate that they are being observed.

If a Service Observer is dropped from a call for any reason, he or she is not added back to the call if conditions change.

A Service Observer cannot activate Service Observing while in the following modes:

- Programming
- Feature (if the telephone is off-hook)
- Test
- Administration
- Maintenance
- Extension Directory

A Service observer cannot activate Service Observing while setting the Alarm Clock or the Timer on the MLX telephone.

Extensions within a Service Observing group do not lose any functionality during Service Observing. Activating any function at the observed extension, such as bridging in a third internal party, however, drops the Service Observer but does not affect the observed extension.

Service Observers can receive internal calls while observing calls.

When a Service Observer begins to observe an idle extension, but the extension makes or receives a call before the Service Observer's SA button times out, the Service Observer cannot observe that call unless the person at the observed extension places the call on hold and picks it up again.

Intercom calls at Service Observing Group extensions can be observed.

Voice Announce calls can be observed at either extension, provided the destination is not already active on a call. If a Service Observer receives a Voice Announce call while on an observed call, the call rings if the speakerphone is already in use.

Voice Announce calls can be observed at the originating extension, unless the originating extension is a QCC.

A person at an observed extension using End-to-End signaling hears the tones. The person does not hear the End-to-End signaling used by the Service Observer's extension.

If an observed extension presses the Mute button during a call, the observer cannot hear the observed extension until the Mute button is deactivated; however, the Service Observer can hear the other parties on the call. If the Service Observer presses the Mute button, it has no effect on a call being observed.

Telephone Differences

Direct-Line Console (DLC)

A DLC can be a Service Observer and can be a member of a Service Observing group.

Queued Call Console (QCC)

Service Observing cannot be programmed on a QCC.

Other Multiline Telephones

Any MLX telephone can be a Service Observer or a member of a Service Observing group.

An ETR, MLS, or analog multiline telephone can be a member of one or more Service Observing groups but cannot be programmed as a Service Observer.

Single-Line Telephones

A single-line telephone cannot be a Service Observer but can be in a Service Observing group. A single-line telephone connected to an MFM also can be a member of a Service Observing group.

An off-premise telephone can be a member of a Service Observing group.

MLX Adjuncts

In Range Out of Building

An IROB telephone can be a member of a Service Observing group. If an IROB telephone is an MLX telephone, it can be a Service Observer.

Video Endpoint

A video endpoint cannot be programmed as a Service Observer and cannot be observed.

Feature Interactions

Auto Answer All

Calls answered by using Auto Answer All can be observed.

Auto Answer Intercom

Calls answered by using Auto Answer Intercom can be observed. Calls answered by using HFAI can be observed.

Auto Dial	<p>Service Observers can use Inside Auto Dial and DSS buttons to select extensions they want to observe.</p> <p>If an observed extension uses one-touch Transfer (automatic or manual), the observer is removed from the call when the call is placed on Hold for the transfer. If an observed extension uses One-Touch Hold, the observer is removed from the call; however, the Service Observing session is still enabled. If the Service Observer tries to use one-touch Transfer or Hold while observing an extension, nothing happens.</p> <p>If a Service Observer has Auto Dial buttons programmed for extensions in its Service Observing group, incoming calls that can be observed lights the green LED next to the Auto Dial button. However, the green LED is not a guarantee that an observable call has arrived; it may simply mean the extension has activated Do Not Disturb.</p> <p>Calls made by using Auto Dial Outside can be observed.</p>
Automatic Route Selection	<p>Calls made by using ARS can be observed when end-of-dialing is reached.</p>
Barge-In	<p>Service Observers can observe external calls that have been barged-in by internal users, either at the barged-in extension or at the extension that has barged-in.</p>
Call Waiting	<p>The Call Waiting tone is heard only at the extension that is receiving the call. For example, the Call Waiting tone is not heard by the observed extension if the waiting tone sounds at the Service Observer extension, and vice versa.</p> <p>If a Service Observer picks up a Call Waiting call while observing, he or she is dropped from Service Observing.</p>
Callback	<p>A Service Observer can observe a Callback call after the called extension answers the call.</p>
Caller ID	<p>Service Observers do not receive Caller ID information for an observed call, including Calling Party number, Called Party number, Call Type, and Facility ID.</p>
Calling Restrictions	<p>Service Observers that are Outward or Toll restricted can still observe outside calls.</p>
Conference	<p>Service Observing does not interfere with the use of the conference feature by observed extensions. While observing an extension, Service Observers cannot use the Conference feature; a press of the Conf button is ignored by the system. The consultation portion of a call may be observed. Any member of a conference call that is observed does not receive the conference display.</p>

**Conference
(continued)**

Service Observing follows the MERLIN LEGEND limitations for calls, namely that no more than three internal extensions can be on one call, regardless if it is an outside or inside call. Consequently, a Service Observer is dropped from a call when the observed extension places the call on hold for conferencing. If one of the conferencing parties is outside the system, the Service Observer is reconnected when the conference is complete. If the conferencing parties are all internal, the Service Observer is *not* reconnected when the conference is complete.

Selective Drop

Although a Service Observer may be dropped from a conference call, the Service Observing session is still active for the observed extension. When the observed extension receives another call after the conference call, the Service Observer is notified.

An observed extension cannot use Selective Drop to drop a Service Observer from a call, nor can a Service Observer use Selective Drop to hang up an observed call.

Coverage

Calls that arrive on Primary or Secondary Coverage buttons can be observed.

Calls that arrive on Group Coverage buttons can be observed.

Calls that go to Group Calling Coverage and are answered by a calling group agent can be observed.

Integrated or Generic VMI ports cannot be members of Service Observing group; a call sent to one of these ports cannot be observed.

CTI Link

Service Observing cannot be programmed on a CTI link. Extensions serving as CTI links cannot be programmed as Service Observers nor as members of Service Observing groups. If an extension is programmed as a CTI link, it is removed as a Service Observer or a Service Observing group member.

CTI user (client) extensions can be Service Observers as well as members of Service Observing groups.

The Service Observer cannot use a CTI application (such as Passageway Telephony Services or Passageway Direct Connect) while actively observing an extension.

**Direct Line Console
(DLC)**

A DLC MLX telephone can be a Service Observer and can be a member of a Service Observing group.

**Direct Station
Selector (DSS)**

A Service Observer can use a DSS button to enter an extension number to establish an observing session.

Direct Voice Mail

When an extension being observed transfers a call by using Direct Voice Mail, the Service Observer is dropped from that call.

Directories

Calls made by using System, Extension, or Personal directories can be observed.

Do Not Disturb

A Service Observer can observe calls even if the observed extension uses the Do Not Disturb feature.

Activating Do Not Disturb at a Service Observer extension does not block the Service Observer from being alerted when a call comes into an observed extension.

When an extension being observed activates Do Not Disturb, this causes the red LED next to the observed extension's button on the Service Observer's telephone or DSS to light.

Forward/Follow Me

A Service Observer actively observing an extension may activate or cancel Forward or Follow Me without interrupting the observing. The Service Observer simply presses the Feature button and dials the feature code and extension number. The Service Observer, however, does not hear any progress tones while doing this.

Group Calling

A calling group member that answers a call can be observed as long as the calling group is not a voice messaging interface (VMI) calling group. A call coming into a VMI calling group cannot be observed.

If a delay announcement device answers a call, the call cannot be observed while it is at the delay announcement device. If a fax extension has answered a call, the call cannot be observed while it is at the fax extension.

If a Service Observer is a member of a calling group and is observing a call, he or she is considered busy for Group Calling.

Headset Options

A Service Observer with a headset can be a Service Observer and a member of a Service Observing group.

An extension answering a call by using Headset Auto Answer can be observed. If the Service Observer has Headset Auto Answer off and a call comes in to the extension being observed, no zip tone is heard, but the observer's headset automatically begins listening in on the call. A zip tone is heard in the headset when a regular call (one where the Service Observer can talk to the caller) comes in.

If an observed extension uses Headset Hang-up to disconnect a call, the observer is dropped from the call. An observing station can use this feature to end the observation of a call.

If an observed extension uses the Headset/Handset Mute feature, the observing station does not hear the person on that extension but can hear the other parties on the call. If the Service Observer uses the Headset/Handset Mute feature, the observed extension is not aware of it.

If a Service Observer is using a headset and the headset status button is on, the Service Observer must first press an SA button before pressing the Service Observing button to begin an observing session.

Hold	<p>Service Observers cannot place observed calls on Hold. If a person at an observed extension presses Hold, the call is removed from the Service Observer until the call is re-accessed, at which point the Service Observer is re-connected to the call (if the extension is still being observed).</p> <p>If a Service Observer with a DLC programmed for automatic Hold post-selects to another button while observing a call, the DLC is disconnected from the observed call. The call is not placed on hold.</p>
Idle Line Preference	<p>Pressing a Service Observing button selects an SA or SSA button, regardless of the programming for Idle Line Preference.</p>
Last Number Dial	<p>Extensions that use Last Number Dial to place a call can be observed.</p>
Messaging	<p>If a Service Observer is deleting a Leave Word Calling (LWC) message at an MLX telephone, he or she cannot use Service Observing until the task is completed. If a caller is leaving an LWC message at an extension, the call cannot be observed.</p> <p>If a Service Observer is retrieving a message or posting a message, he or she can use the Service Observing feature. If an extension returns a call by using Message Return Call, the call can be observed when it is answered.</p> <p>If a Service Observer on a DLC is using Operator Inspect of Messages at an extension, he or she can observe calls.</p> <p>When a Service Observer observes an extension that has activated Do Not Disturb, the Service Observer does not receive the Do Not Disturb posted message.</p> <p>While a DLC programmed for Service Observing is using Send/Remove Message, it can be used to observe extensions</p>
Multi-Function Module	<p>Voice calls to a telephone connected to an MFM can be observed; data and video calls cannot be observed.</p>
Night Service	<p>If a Night Service call is answered at an extension in a Service Observing group, the call can be observed.</p>
Paging	<p>A Group Page call cannot be observed. A Loudspeaker Page call cannot be observed.</p>
Park	<p>A call that is parked cannot be observed. Once an extension answers a parked call, the call can be observed.</p>
Personal Lines	<p>Calls made or received on Personal Lines can be observed. A Service Observer cannot use a Personal Line to observe a call.</p> <p>Bridging takes priority over Service Observing; an observer is dropped before a bridge is denied. If a call on a Personal Line is being observed and a third internal extension is bridged on to the call, the Service Observer is dropped from the call.</p>

Pickup	When an extension answers a call by using Pickup, the call can be observed.
Pools	<p>If an extension uses Dial Access to make a call, the call can be observed. A call placed or answered on a Pool button can be observed.</p> <p>A Service Observer cannot activate Service Observing while off-hook on a Pool button.</p>
Privacy	Service Observers can observe calls even if the observed extension is using the Privacy feature.
Queued Call Console (QCC)	A QCC cannot be a Service Observer or a member of a Service Observing group. If an extension is on a call with a QCC, the call can be observed at that extension, but not at the QCC's extension.
Reminder Service	Service Observers can observe Reminder Service calls. If a Service Observer is setting or cancelling Reminder service, he or she can observe calls.
Remote Access	Service Observers can observe a Remote Access call if it is answered at an extension on the local system. Remote Access cannot be used to activate Service Observing.
Ringling Options	<p>When a Service Observer is observing an extension and a call comes to the Service Observer's extension, he or she hears abbreviated ringing.</p> <p>The ringing options on an extension or button do not affect Service Observing.</p>
Saved Number Dial	Saved Number Dial calls can be observed.
Signal	A Service Observer can manually signal an extension that is being observed. Likewise, the observed extension can manually signal the observing extension. The signal is a separate call from the observed call.
Speed Dial	If an extension uses Personal or System Speed Dial to place a call, the call can be observed.
SMDR	SMDR reports do not record the activity of the Service Observer extension for Service Observing calls.
System Access/ Shared System Access Buttons	<p>Bridging takes priority over Service Observing. If another extension bridges onto a call at an observed extension, the Service Observer is dropped.</p> <p>A Service Observing session can be established only when an SA button is available on which to go off-hook. Similarly, a Service Observer cannot receive notification of an observable call if all the SA buttons on his or her telephone are already in use.</p> <p>If a Service Observer goes off-hook on a non-SA button, he or she can post-select to an SA button and establish a Service Observing session. If a Service Observer post-selects while observing an extension, he or she is disconnected from the call.</p>

**System Access/
Shared System
Access Buttons
(continued)**

A Service Observer who pre-selects an SA button can establish a Service Observing session when he or she goes off-hook.

A Service Observer can be off-hook on an SA Originate Only, SA Ring/Voice Option, or SSA button and initiate Service Observing.

Calls made on SA Originate Only and SA Ring/Voice Option buttons can be observed. A call placed or received on an SSA button can be observed

If a Service Observer is observing a call and there is an SSA button for the SA button the call appears on, the extension with the SSA button cannot bridge onto the call. The SSA button receives the same treatment as if Privacy were active.

Transfer

A Service Observer cannot transfer observed calls.

If an observed extension transfers a call, the Service Observer is dropped from the call when the transfer is initiated and when it is completed, but the Service Observing session remains active. If the observed extension consults the destination station before the transfer is completed, the Service Observer hears the consultation. Either extension involved in a consultation can be observed.

If the Service Observer is observing the extension that originally made the call, the Service Observer remains on the call when the transfer is completed.

If the Service Observer is observing the extension that is the destination of the transferred call, the Service Observer hears the call when the transfer is completed.



NOTE:

The most important thing to remember is that a Service Observer observes an extension, not a call. Whenever that extension is active on a call (whether the extension is the originator, the transferer, or the recipient of the call), the Service Observer can observe the call.

Transfer return and transfer redirect calls can be observed.

Trunk-to-trunk transfer calls drop the observer at the completion of the transfer.

UDP Features

Calls coming across a private network can be observed just like outside calls. A Service Observer cannot observe non-local extensions.

Signal/Notify

At a Glance

Users Affected	Telephone users, operators
Reports Affected	Extension information
Modes	All
Telephones	All except QCC and single-line telephones
Programming Codes	
Signal	*23 + ext. no.
Notify, Send	*757 + ext. no.
Notify, Receive	*758 + ext. no.
MLX Display Labels	
Signal	Signal [Signl]
Notify, Send	Notify,Send [Ntfy,Send]
Notify, Receive	Notify,Receive [Ntfy,Recv]

Description

A user can signal another telephone user without making a call to that extension, using either the Signal feature, which beeps the destination extension, or the Notify feature, which lights an LED on the destination extension. The meaning of the signal can be prearranged between the sending and receiving users.

Signal

The Signal feature allows a multiline telephone user to beep another telephone. To use the feature, press a programmed Signal button without lifting the handset. A beep is heard at the destination extension for as long as the sender holds the button down.

In addition to sending a beep, the Signal button can be used to see the status of the destination extension. When the destination user lifts the handset or uses Do Not Disturb, the green LED next to the Signal button turns on.

A user also can use the Signal button to dial the destination automatically. However, the user must select an SA or ICOM button and either lift the handset or press the Speaker button before using the Signal button; this is different from Auto Dial, which automatically selects a line and activates the speakerphone.

Notify

Notify allows a multiline telephone user to light an LED on another telephone. To use this feature, a Send button must be programmed at the sender's telephone and a Receive button must be programmed at the receiver's telephone. These buttons are typically labeled with the names of the sender and recipient, for example, "Notify Mary" at the sending telephone and "Call Consuela"—at the receiving telephone.

When the sender presses the Send button, a green LED turns on next to the Receive button at the receiver's telephone and the Send button at the sender's telephone. Both LEDs remain on until either the sender presses the Send button again or the receiver presses the Receive button.

The visual notification, lighting the destination telephone's LED, is sent only one way, from the sender to the receiver. If both users want to send and receive the visual notification, both telephones must be programmed with Send and Receive buttons. Unlike the Signal feature, Notify cannot be used to see the status of a destination extension, nor can it be used to automatically dial the extension.

Considerations and Constraints

Signal and Notify can be used even when both users are on the telephone.

Telephone Differences

Queued Call Consoles

Notify and Signal buttons cannot be used on QCCs; however, pressing a DSS button sends a signal to the extension associated with the DSS button in the following instances:

- A QCC operator is timed out from dial tone on a Call button or presses the Forced Release button while listening to dial tone on a Call button.
- A QCC operator, with a call in a split condition, presses the Source button after contacting the destination but does not connect both parties by using the Join button. If the operator presses a DSS button, a signal is sent to the destination extension.

Other Multiline Telephones

Both Signal and Notify require a programmed button (Notify requires two). MLX display telephone users cannot select either of these features from the display.

Single-Line Telephones

Neither Signal nor Notify can be used on single-line telephones.

Feature Interactions

Auto Dial	A Signal button and an Auto Dial button cannot be programmed for the same extension. If a user tries to program one of these buttons while the other is already programmed, the feature being programmed erases the previously programmed feature.
Conference	Signal and Notify can be used during a conference call.
Digital Data Calls	Signaling can be activated by video systems that have the ability to dial strings and feature codes beginning with #.
Direct Station Selector	If a user presses a Signal button programmed with a system operator's extension while making a call to the system operator, the LED next to the operator's DSS button changes from flashing to steady while the Signal button is held down.
Do Not Disturb	Signal cannot be used when the destination telephone user activates Do Not Disturb.
Group Calling	A Signal button cannot be programmed for a calling group.
Messaging	If a display telephone user presses a Signal button only to send an audible signal with a posted message to a telephone, the posted message is not shown on the display at the destination. If a display telephone user, however, selects an SA or ICOM button, lifts the handset, and <i>then</i> uses the Signal button to dial the extension, the posted message is shown at the destination telephone.
Multi-Function Module	When set for supplemental alert adapter operation, an MFM can receive a signal but cannot send one. An MFM cannot receive a signal when set for tip/ring operation.
Privacy	Users can program and use the Signal and Notify features to signal co-workers who have activated Privacy.
Service Observing	In Release 6.1 and later systems, a Service Observer can manually signal an extension that is being observed. Likewise, the observed extension can manually signal the observing extension. The signal is a separate call from the observed call.
Transfer	A Signal button can be used to dial the extension during a transfer after the Transfer button and either an SA or ICOM button is pressed. Signal buttons cannot be used to initiate one-touch Transfer.
UDP Features	In Release 6.0 and later systems (Hybrid/PBX mode only), Signal/Notify features do not function across a private network.

Speed Dial

At a Glance

Users Affected	Telephone users, operators, data users
Reports Affected	Extension Information, System Directory
Modes	All
Telephones	
System Speed Dial	All except QCC
Personal Speed Dial	Multiline telephones with ten or fewer buttons, single-line telephones, data equipment
Programming Codes	
System Speed Dial	* 24 + System Speed Dial code
Personal Speed Dial	# + Personal Speed Dial code (01–24) + * 21 + dial-out code + tel. no. + ##
MLX Display Label	SysSpeedDl [SpdDl]
System Programming	Create, change, or delete System Speed Dial entries: ■ More→Labeling→Directory→System
Maximums	
System Speed Dial	130 numbers in the system 40 characters for each number 11 characters for each label
Personal Speed Dial	1,200 numbers in the system 24 numbers for each user 28 characters for each number
Factory Settings	
System Speed Dial Codes	600–729
Personal Speed Dial Codes	01–24 for 5-button, 10-button, data equipment, and single-line telephones 01–18 for 16-button telephones

Description

System Speed Dial and Personal Speed Dial allow users to dial outside numbers quickly, using a 2- or 3-digit code.

System Speed Dial

System Speed Dial lets the system manager program frequently used numbers that can be dialed from any extension (including data workstations) using a 3-digit code.

In Hybrid/PBX mode, numbers can include pool dial-out codes or the ARS code. When dial-out codes are included, Pause characters may be required immediately following the dial-out code to allow time to receive the telephone company dial tone.

System Speed Dial numbers are programmed by using the Labeling feature. The programmed labels include the name of the business or person being called and the number dialed. When a person with a display telephone uses a Speed Dial code to dial the number, the number being dialed appears on the display unless it is a *marked* Speed Dial number.

For numbers that include confidential information, such as passwords or account billing numbers, the listing can be specifically designated in system programming to suppress the number dialed so that users with display telephones see only the code that is dialed (600–729) and not the number dialed. This is called a *marked* System Speed Dial code. When a number is dialed using a marked System Speed Dial code, any calling restrictions (such as toll or outward restrictions) assigned to the extension are overridden. In addition, the System Speed Dial code is printed on Station Message Detail Recording (SMDR) reports instead of the number.

The range of numbers available for System Speed Dial codes is 600 through 729; this range cannot be changed.

The codes are available to all users except QCC operators. On multiline telephones, line buttons can be programmed with individual 3-digit System Speed Dial codes. Each System Speed Dial code must be programmed on a separate button.

System Speed Dial numbers are stored in the System Directory. MLX display telephone users can search the directory and select a listing by pressing a display button to dial the number. Users with analog multiline display or nondisplay telephones dial the same numbers either by using the 3-digit System Speed Dial codes or by programming individual System Speed Dial codes onto buttons.

Personal Speed Dial

Personal Speed Dial allows a user to program up to 24 numbers that can be dialed using a 2-digit code. Personal Speed Dial is used only by single-line telephone users and users with multiline telephones having 16 or fewer buttons—for example, MLX-5, MLX-5D, MLX-10, MLX-10D, or MLX-16DP telephones. Personal Speed Dial may be used by digital data workstations and modem data-only workstations, but all numbers must be programmed for the communications device through centralized telephone programming.

Personal Speed Dial allows a user to dial a 2-digit code for long numbers that may require, for example, account codes, long-distance company access codes, and

area codes. In Hybrid/PBX mode, a Personal Speed Dial number also can include pool dial-out codes or the ARS code. When dial-out codes are included, Pause characters may be required immediately following the dial-out code to allow time to receive the telephone company dial tone.

The Personal Speed Dial codes used to select specific programmed numbers are 01 to 24. Because each user has the same codes from which to choose, the telephone numbers for the codes apply only to the extension for which they were programmed.



NOTE:

This feature should be used with BIS-10, MLC-5, MDW 9000, MDC 9000, MLX-5, MLX-5D, MLX-10, MLX-10DP, MLX-16DP, MLX-10D, ETR-6, and MLS-6 telephones *only*. MLX-20L telephone users should program a Personal Directory instead of Personal Speed Dial codes. MLX-28D, ETR-18/18D, ETR-34D, MLS-12/12D, MLS-18/18D, and MLS-34D telephone users and users of analog multiline telephones with more than ten buttons should program Auto Dial buttons instead of Personal Speed Dial codes. Programming Personal Speed Dial codes on telephones with more than ten buttons may delete features already programmed onto those buttons.

Considerations and Constraints

Personal Speed Dial numbers can be used only with single-line telephones, digital data devices, modem data-only workstations, and multiline telephones with 16 or fewer buttons.

In Release 1.1 later systems, when you are programming Personal Speed Dial on MLX-5D, MLX-10D, MLX-10DP, or MLX-16DP telephones, select **Enter** from the display after dialing the telephone number. Otherwise, the number is not programmed.

A number dialed by using a marked System Speed Dial code overrides any calling restrictions (such as toll or outward restrictions) assigned to the extension.

The following special characters can be used in numbers programmed for Speed Dial codes: Pause (Hold), Stop (Drop), Flash (Conf), and End of Dialing (#). See [Appendix H, "Programming Special Characters,"](#) for additional information.

When a pool dial-out or ARS code is included in the dialing sequence associated with a Personal Speed Dial or System Speed Dial code, pauses may be required immediately after the dial-out code to allow time to receive outside dial tone.

Personal and System Speed Dial cannot be used at rotary dial telephones.

Personal Speed Dial can be used at digital data and modem-only workstations, but must be programmed through centralized telephone programming.

On multiline telephones, line buttons can be programmed with individual System Speed Dial codes. Each System Speed Dial code must be programmed on a separate button.

Personal Speed Dial should not be confused with Personal Directories. See [“Directories” on page 263](#) for more information.

Mode Differences

Hybrid/PBX Mode

A pool dial-out code or an Idle Line Preference access code can be included with the telephone number in a Personal Speed Dial or System Speed Dial code. To allow time to receive a local telephone company dial tone, Pause characters may be required immediately following either a pool dial-out code or an access code for a long-distance carrier. Pauses are not needed following the ARS code.

When ARS is used, press the pound sign (#) twice after the dialed digits during programming of a Personal Speed Dial or System Speed Dial code for a 7-digit toll number. This signals the end of the dialing sequence. See [Appendix H, “Programming Special Characters,”](#) for information about special characters.

Behind Switch Mode

The user can program into Personal Speed Dial or System Speed Dial codes any dial-out codes required by the host system.

To allow time to receive a telephone company dial tone, Pause characters may be programmed after a pool dial-out code. Pause characters may also be required by the host system or after entering an access code for a long-distance carrier.

Telephone Differences

Direct-Line Consoles

System Speed Dial numbers can be programmed from the first DLC connected to the first analog extension jack. In extension programming, press the Feature button or pound sign (#), the 3-digit System Speed Dial code, the outside telephone number, and the pound sign.

Queued Call Consoles

Personal Speed Dial and System Speed Dial cannot be used to dial numbers on a QCC. Directory features can be used instead.

Other Multiline Telephones

System Speed Dial

To dial a System Speed Dial number, press a System Speed Dial button programmed with the code. Alternatively, lift the handset, press the Feature button, and dial the System Speed Dial code associated with the number. Analog multiline telephone users without programmed Feature buttons should select an SA or ICOM button, lift the handset, and dial the System Speed Dial code.

Personal Speed Dial

Users of multiline telephones with more than ten buttons should not use Personal Speed Dial; doing so may delete features already programmed onto buttons. To dial a Personal Speed Dial number on a multiline telephone, press the Feature button and dial the Personal Speed Dial code (01–24) associated with the number. While off hook, or on an SA or ICOM button, at an analog multiline telephone without a programmed Feature button, dial # and the Personal Speed Dial Code.

Starting with Release 1.1, when programming Personal Speed Dial numbers, MLX-10D and MLX-5D telephone users must select `Enter` from the display after dialing the telephone number.

Single-Line Telephones

To dial a Personal Speed Dial or System Speed Dial number using a single-line telephone, lift the handset and, while listening to inside dial tone, dial # and the Speed Dial code.

In Release 5.0 and later systems, the first Personal Speed Dial number (code 01) programmed for a single-line telephone is used by the HotLine feature. This inside or outside number is dialed automatically when a user goes off-hook at a single-line telephone programmed as a HotLine. The Personal Speed Dial number may be programmed at the telephone prior to its being assigned as a HotLine extension. Once the extension is programmed as a HotLine extension, programming at the extension can occur only once, and any further programming for the HotLine extension must be performed through centralized programming.

Feature Interactions

Account Code Entry	A System Speed Dial number or a Personal Speed Dial number can be programmed to replace a long account number, but it cannot be programmed to contain both an account number and a telephone number. Single-line telephones cannot use Personal Speed Dial or System Speed Dial to dial account codes because the # required to use Speed Dial is also used to terminate Account Code Entry.
Allowed/ Disallowed Lists	A user with an outward- or toll-restricted telephone cannot dial an outside number by using a Personal Speed Dial or System Speed Dial code (excluding a marked System Speed Dial code), unless the number is on an Allowed List assigned to the extension. A user cannot dial an outside number by using Personal Speed Dial or System Speed Dial if the number is on a Disallowed List assigned to the extension, unless the number is dialed using a marked System Speed Dial code.
Authorization Code	Users cannot enter authorization codes by using a System Speed Dial or Personal Speed Dial code because these features are activated by dialing #. Pressing # completes the entry of an authorization code and cannot also be used to activate speed dial features.
Automatic Route Selection	Personal Speed Dial and System Speed Dial numbers can include the ARS code.
Callback	When a Stop character is programmed as part of a Speed Dial number, stay on the line, wait for the callback call, and then reactivate Speed Dial. This signals the system to continue dialing the digits following the Stop character.
Calling Restrictions	When a marked System Speed Dial code is used to dial a number, any calling restrictions (such as toll or outward restrictions) assigned to the extension are overridden.
Conference	Press the Conf button to enter the Flash special character in a Personal Speed Dial or System Speed Dial telephone number.
Digital Data Calls	Personal and System Speed Dial codes can be used on digital communications equipment (DCE). Speed Dial codes can be used only on digital video systems that have the ability to dial feature codes or number strings beginning with #.
Directories	System Speed Dial numbers are stored in the System Directory. MLX display telephone users can dial the numbers by selecting the name from the display. If the number is on a marked System Directory listing, select the listing and dial the number regardless of any calling restrictions (toll and outward) assigned to the extension.
Drop	The Drop button is pressed to enter the Stop special character in a Personal Speed Dial or System Speed Dial telephone number.
Hold	The Hold button is pressed to enter the Pause special character in Personal Speed Dial or System Speed Dial telephone numbers.

HotLine	A HotLine extension (Release 5.0 and later systems) can dial only the first Personal Speed Dial number (code 01) programmed for the extension. The end-of-dialing digit, #, should be programmed at the end of the speed dial number. See Appendix H, "Programming Special Characters," for additional information.
Labeling	The telephone numbers associated with System Speed Dial codes are entered by using the programming screens to program labels for System Directory listings.
Last Number Dial	Telephone numbers that are dialed by using Personal Speed Dial are stored by Last Number Dial. If the stored number includes a special character, such as Pause or Stop, however, the special character does not work when the number is redialed by using Last Number Dial. Telephone numbers that are dialed by using a System Speed Dial code are not stored by Last Number Dial.
Pools	A pool dial-out code can be programmed on Personal Speed Dial and System Speed Dial numbers. When a pool dial-out code is included in the number dialed, Pause characters may immediately follow the dial-out code to allow time to receive a local telephone company dial tone.
Recall/Timed Flash	The Conf button is used to enter the Flash special character, which simulates pressing the Recall button in a Personal Speed Dial or System Speed Dial telephone number.
Saved Number Dial	Telephone numbers that are dialed by using a Personal Speed Dial code are stored by Saved Number Dial. If the number includes a special character, such as Pause or Stop, the special characters do not work when the number is redialed by using Last Number Dial. Telephone numbers that are dialed by using a System Speed Dial code are not stored by Saved Number Dial.
Second Dial Tone Timer	Marked System Speed Dial entries—entries that do not display—are not affected by the Second Dial Tone setting. If the central office does not immediately supply dial tone when a star code is entered and a marked System Speed Dial entry uses star codes, then the appropriate number of pauses (each 1.5 seconds) must be programmed in the entry following each star code.
Service Observing	In Release 6.1 and later systems, if an extension uses Personal or System Speed Dial to place a call, the call can be observed.
SMDR	When Personal Speed Dial or System Speed Dial is used to dial an outgoing call, the actual digits dialed by the system appear on the report. However, when a marked System Speed Dial number is used, the Speed Dial code, rather than the digits dialed, prints on the report.
Transfer	Both Personal and System Speed Dial can be used to dial a transfer destination.
UDP Features	In Release 6.0 and later systems (Hybrid/PBX mode only), non-local dial plan numbers can be programmed as speed dial numbers. System Speed Dial numbers can only be accessed by local system users.

Station Message Detail Recording (SMDR)

At a Glance

Users Affected	Telephone users, operators, data users, system manager
Reports Affected	System Information (SysSet-up)
Modes	All
System Programming	<p>Select types of outside calls recorded:</p> <ul style="list-style-type: none"> ■ Options→SMDR→Call Report <p>Select whether to record private-network calls:</p> <ul style="list-style-type: none"> ■ Options→SMDR→UDP <p>Select minimum duration of calls recorded:</p> <ul style="list-style-type: none"> ■ Options→SMDR→Call Length <p>Select report format:</p> <ul style="list-style-type: none"> ■ Options→SMDR→Format <p>Select whether authorization code is recorded instead of account code (Release 3.0 and later systems only):</p> <ul style="list-style-type: none"> ■ Options→SMDR→AuthCode <p>Enable or disable Talk Time option (Release 4.2 and later systems only):</p> <ul style="list-style-type: none"> ■ Options→SMDR→Talk Time
Hardware	Printer needed for reports
Maximums	
Queue	100 records
Called Number Field	15 digits
Factory Settings	
Authorization Code	Account Code displayed (if entered, Release 3.0 and later systems only)
Talk Time	Disabled (Release 4.2 and later systems only)
Calls Recorded	Incoming and outgoing calls
Call Length	40 sec (range 0–255)
Format	Basic

Description

Station Message Detail Recording (SMDR) captures detailed information about incoming and outgoing voice and data calls. The information is sent to an output device such as a printer or an optional call accounting or analysis system.

SMDR records are gathered sequentially and sent to the RS-232 SMDR jack on the processor module of the control unit. They can be printed on a serial printer connected to the SMDR jack. To assist further with cost allocation and unauthorized call detection, a Lucent Technologies Call Accounting System (CAS Plus V3, CAS for Windows, CAT/B, or CAT/H) can be connected to the SMDR jack on the control unit. In Release 4.2 and later systems, the optional MERLIN LEGEND Reporter software application allows the collection and analysis of calling group call information via a PC running Windows, connected to the SMDR jack on the control unit.



NOTES:

- For an overview of the applications that you can purchase separately, see [Appendix I](#), “[Applications](#).” For more detailed information, see the application documentation or consult your Lucent Technologies representative.

- You cannot have CAS (Call Accounting System) and MERLIN LEGEND Reporter active at the same time. Use CAS for costing information and MERLIN LEGEND Reporter for analyzing service performance.

Two SMDR report formats are available: the factory-set Basic format and the ISDN format. The ISDN format is used when the business subscribes to the AT&T INFO2 ANI service, another ISDN/PRI network service (Release 4.2 and later systems), or to Caller ID service (requiring an 800 GS/LS-ID module for the loop-start lines on which the service is provided). When the ISDN format is selected during system programming, the CALLED NUMBER field of the call report shows the number dialed by a party calling into the system on a line where the service is provided. (Not all calling numbers can be identified; for details, see [“Caller ID” on page 125.](#))

Call information can be recorded for incoming and outgoing calls (the factory setting) or for outgoing calls only. In Release 4.2 and later systems, enabling the Talk Time option permits recording of incoming calls to Auto Login or Auto Logout calling groups, even if SMDR is programmed for outgoing calls only. Incoming calls to other calling groups still strictly adhere to the Call Report type setting.

The system is factory-set to record only calls that last at least 40 seconds. This setting can be changed to timing in the range 0 to 255 seconds. In Release 4.2 and later systems, enabling the Talk Time option permits recording of incoming calls to Auto Login or Auto Logout calling groups, even if the call length is less than the programmed minimum number of seconds. Incoming calls to other calling groups still strictly adhere to the minimum call length value.

In Release 6.0 (Hybrid/PBX mode only), any call originating on a tandem trunk appears on the SMDR report, as do any calls originating on or passing through the local system. Calls to non-local extensions are treated as outside calls for the

purpose of SMDR. SMDR reports may report calls using more than one call record on more than one system. Depending upon how SMDR is programmed and how calls are routed, you may need to consult several SMDR records to trace a call that is routed over network trunks. To log network calls, SMDR should be programmed to report both incoming and outgoing calls. See the *Network Reference* for more details about incoming and outgoing calls.

In Release 6.1 and later systems, the system can be programmed to produce SMDR reports for tandem trunks connected to other systems in the private network. If the system is programmed to log SMDR records for private-network trunks, all private-network calls are logged. If the system is programmed not to log SMDR records for private network trunks, no private-network calls are logged for the system unless the call involves an outside line. The factory setting is not to log.

In Release 4.1 and prior systems, incoming call timing (assuming that incoming calls are included in the call report) begins when a user answers the call. In Release 4.2 and later systems, the same holds true for incoming calls if the Talk Time option is disabled (the factory setting); if the Talk Time option is enabled, timing on incoming calls to Auto Login and Auto Logout calling groups begins when the call is initially detected in the system, while timing on incoming calls to other calling groups begins when the call is answered.

Timing stops for both incoming and outgoing calls when the call is disconnected. In Release 2.1 and later systems, call timing for outgoing calls on PRI lines begins when the call is answered at the far end. For outgoing calls, timing begins when dialing is complete, that is, when the system detects the end of dialing. Therefore, no SMDR record is generated for unanswered calls made on these lines.

In Release 4.2 and later systems, the SMDR feature includes enhancements to support sales and customer service calling groups; these improvements are outlined in this topic. They are designed to allow use of the Lucent Technologies MERLIN LEGEND Reporter software application, which assists in determining the effectiveness of calling group agents, in assessing the level of service provided to incoming callers, and in pinpointing needs for additional lines or agents to provide the best possible service for an organization's customers.

SMDR Report Fields

[Figure 32](#) shows a sample SMDR report in ISDN format. The topics that follow describe each of the fields (columns) in an SMDR report.

1	2	3	4	5	6	7	8	9	10
	DATE	TIME	CALLED NUMBER	TAG	DUR.	LINE	STN.	ACCOUNT	TALK
C	10/27/97	09:59			00:00:30	801	4118	123456	
C	10/27/97	10:00	IN*		00:15:57	801	4114	129345	15:51
C	10/27/97	10:00	IN		00:05:31	804	4116	129345	05:28
C	10/27/97	10:02	IN		00:12:42	802	4118	435555	12:13
I	10/27/97	10:02	IN&		00:00:55	803	4115	459995	00:48
I	10/27/97	10:03	555-3633		00:00:53	803	4118		
D	10/27/97	10:03	555-4141*		00:01:33	805	4115	122345	
I	10/27/97	10:05	91212-555-1236		00:01:33	803	4126	111345	01:28
C	10/27/97	10:07	215-555-1234!		00:10:33	803	4114	129345	

Figure 32. Sample SMDR Report in ISDN Format

A page heading indicates the name of most fields in an SMDR record. Caller ID is available in Release 3.0 and later systems only. The TALK field is available in Release 4.2 and later systems only. Interpret each field as described in the following topics.

CALL TYPE (Column 1)

In Basic format, the values in this column have the following meanings:

- C indicates an incoming or outgoing voice call on an analog or digital facility.
- D indicates an incoming or outgoing data call on a digital facility.

In ISDN format, Release 2.0 and earlier systems, the values in this column have the following meanings:

- C indicates an incoming or outgoing voice call on a non-PRI facility.
- D indicates an outgoing data call on a PRI facility.
- I indicates an incoming voice or data call on a PRI facility.

In ISDN format, Release 3.0 and 3.1 systems, the values in this column have the following meanings:

- C indicates either an outgoing voice call or an incoming voice call without ANI or Caller ID information.
- D indicates an outgoing data call on a PRI facility.

- I indicates either an incoming voice call with ANI or Caller ID information, or a data call on a PRI or other facility equipped to receive the caller's number.

In ISDN format, Release 4.0 and later systems, the values in this column have the following meanings:

- C indicates either an outgoing voice call or an incoming voice call without ANI or Caller ID information.
- D indicates an outgoing data call on a PRI, BRI, or T1 facility.
- I indicates an incoming voice or data call with ANI or Caller ID information on a PRI, BRI, or other facility equipped to receive the caller's number.

DATE (Column 2)

The date is shown in mm/dd/yy format with leading zeros.

In Release 4.1 and prior systems, the reported date is as follows:

- When an incoming call was answered.
- When an outgoing call was originated. (The system detected end of dialing.)

In Release 4.2 and later systems, the reported date is as follows:

- For Auto Login or Auto Logout calling groups with Talk time enabled, when an incoming call was detected in the system.
- When any other incoming call was answered, regardless of the Talk Time option status.
- When an outgoing call was originated. (The system detected end of dialing.)

TIME (Column 3)

The time is shown in hh:mm 24-hour (military) format.

In Release 4.1 and prior systems, the reported time is as follows:

- When an incoming call was answered.
- When an outgoing call was originated. (The system detected end of dialing.)

In Release 4.2 and later systems, the reported time is as follows:

- For Auto Login or Auto Logout calling groups with Talk time enabled, when an incoming call was detected in the system.

- When any other incoming call was answered, regardless of the Talk time status.
- When an outgoing call was originated. (The system detected end of dialing.)

CALLED NUMBER (Column 4)

Depending upon the type of line used for a call and whether it provides caller identification information, this field displays either `IN` or a telephone number. The maximum number of digits printed in this field is 15. A question mark (?) in the CALL TAG field (Column 5) indicates that the number overflowed because it was longer than 15 digits.

For an incoming call in Basic format, this field displays `IN`. The balance of this topic describes the field's contents when the ISDN format is used.

In Release 2.0 systems, Column 4 displays the following values for an incoming call in ISDN format:

- `IN` on a non-PRI facility or on a PRI facility where no caller information is available.
- If available, ANI on a PRI facility.

In Release 3.0 systems, Column 4 displays the following values for an incoming call in ISDN format:

- `IN` on a non-PRI facility or on any facility where no caller information is available.
- If available, ANI on a PRI facility or Caller ID on a loop-start facility using an 800 GS/LS-ID module.

In Release 4.0 and later systems, Column 4 displays the following values for an incoming call in ISDN format:

- `IN` on a non-PRI facility or on any facility where no caller information is available.
- If available, ANI on a PRI or BRI facility or Caller ID on a loop-start facility connected an 800 GS/LS-ID module.

For an outgoing call, the CALLED NUMBER field displays one of the following two values:

- Dialed digits.
- The marked System Speed Dial code when dialed digits are suppressed to address privacy or security concerns.

CALL TAG (Column 5)

This section describes the symbols that appear in call records, in order of precedence. The last topic in this section explains conditions under which the field is left blank.

Asterisk (*). For an incoming call in systems prior to Release 4.2 and in Release 4.2 and later systems with the Talk Time option disabled, this column displays an asterisk (*) only when the caller disconnected after the call was answered anywhere in the system. For an outgoing call, an asterisk (*) indicates that the called party disconnected. If the call was on a loop-start facility without reliable disconnect supervision, no asterisk (*) appears.

In Release 4.2 and later systems when the Talk Time option is enabled, an asterisk is also displayed when a call arrived for an Auto Login or Auto Logout calling group and the caller hung up before talking to a group member, even if the caller was connected to the system. This functionality provides more specific information about these types of calls. For example, an asterisk (*) appears when the caller hung up while waiting in the calling group queue or the QCC overflow queue. An asterisk is also recorded when a call was transferred to an Auto Logout or Auto Logout calling group and the caller abandoned the call while waiting in the queue. In either case, the TALK field records zero (00:00).

Question Mark (?). A question mark (?) appears when the reported telephone number exceeded 15 digits in length.

Ampersand (&). This symbol appears in Release 4.2 and later systems only when the Talk Time option is enabled, and only for incoming calls to an Auto Login or Auto Logout calling group. An ampersand (&) is recorded if the call was answered by the Auto Login or Auto Logout overflow calling group (overflow call). A duration greater than zero (00:00) appears in the TALK field.



NOTE:

If the calling group type is Integrated or Generic Voice Messaging Interface (VMI), an ampersand does not appear on the incoming call record for an overflow call, even if the overflow receiver is an Auto Login or Auto Logout calling group. In this case, the overflow calling group is considered the intended call destination and the call is not reported as an overflow call. For more information about Auto Login, Auto Logout, Generic VMI, and Integrated VMI calling group types, see [“Group Calling” on page 350](#).

Exclamation Point (!). An exclamation point (!) is recorded in Release 4.2 and later systems for incoming calls to an Auto Login or Auto Logout calling group when the Talk Time option is enabled. An exclamation point (!) and a Talk Time duration of zero (00:00) indicate that the call was picked up by someone other than a calling group member. A Talk Time duration greater than zero (00:00) is reported under the following circumstances:

- The incoming call was answered elsewhere in the system and then disconnected.
or
- The call was answered by the QCC overflow receiver for the calling group.
or
- The call was transferred without consultation to an Auto Login or Auto Logout calling group member who answered the call.



NOTE:

By comparing the duration of the call (DUR. field) and the TALK field value for eligible calls, you can determine how long the caller waited, beginning at the time when the call arrived at the system. MERLIN LEGEND Reporter calculates this value, along with others such as the average talk time for agents, to create reports about call center performance.

Blank Field. The CALL TAG field is blank for the following types of calls when neither party abandoned the call after connecting and none of the other symbols apply:

- Outgoing calls when the called number does not exceed 15 digits.
- In releases prior to 4.2 and in Release 4.2 and later systems with the Talk Time option disabled, incoming calls where the called party disconnected.
- In Release 4.2 and later systems with the Talk Time option enabled, incoming calls to Auto Login or Auto Logout calling groups where a group member answered the call on a line assigned to the group.
- In Release 4.2 and later systems with the Talk Time option enabled, incoming calls that are answered by an operator, then transferred to and answered by a Auto Login or Auto Logout calling group.
- In Release 4.2 and later systems with the Talk Time option enabled, incoming calls first answered by an automated attendant, then transferred to and answered by a Auto Login or Auto Logout calling group.
- In Release 4.2 and later systems, incoming calls made to extensions other than calling groups programmed for Auto Login or Auto Logout operation, regardless of the Talk Time option.

DUR. (Column 6)

The time is shown in hh:mm:ss format with a maximum value of 99:59:59. The system times an outgoing call from the completion of dialing until the call is disconnected.

In Release 4.1 and prior systems, Column 6 displays the duration of an incoming call. Timing starts when the call is answered and ends when the call is disconnected.

In Release 4.2 and later systems with the Talk Time option enabled, Column 6 records the duration of incoming calls for Auto Login and Auto Logout calling group beginning when the system detects the arriving call. When the Talk Time option is disabled or when the call is not for an Auto Login or Auto Logout calling group, timing starts when the call is answered and ends when it is disconnected.

LINE (Column 7)

The incoming or outgoing line/trunk used for the call.

STN. (Column 8)

For outgoing calls, Column 8 displays the extension number where the call was placed.

In Release 4.2 and later systems, Column 8 displays extension numbers for incoming calls as follows:

- If the Talk Time option is disabled, the extension number that first answered, overridden only when the call is transferred to another extension or parked and picked up by another extension.
- If the Talk Time option is enabled, the extension number of an Auto Login or Auto Logout calling group member who answered.
- If the Talk Time option is enabled and the calling party disconnected before a member of an Auto Login or Auto Logout calling group answered, either the extension number of the last delay announcement device that handled the call or the calling group member extension number where the call was alerting when the caller hung up. If the call was transferred to the calling group and not handled by a group member or delay announcement device, Column 8 includes the extension number of the transfer originator.
- If blank, the caller disconnected while the call waited in the calling group queue for answering by an announcement device or an agent.

In Release 4.1 and prior systems, Column 8 displays the number of the extension where an incoming call was answered, overridden only when the call is transferred to another extension or parked and picked up by another extension.

ACCOUNT (Column 9)

In Release 1.0 and later systems, Column 9 displays the following values:

- The account code, if entered, for an incoming or outgoing call attributed to a specific project, department, or employee for billing purposes.

- If the incoming call was a successful remote access call, either the 2-digit barrier code ID number (01–16) preceded by six consecutive 9s, or 99999900, indicating that no barrier code was required, overridden only when an account code was subsequently entered.
- If the remote access caller failed to enter the correct barrier code, 16 zeros or 999999.

In Release 3.0 and later systems, Column 9 also can display either the authorization code (if entered with the option enabled) or the extension that placed the outgoing call for a call that exceeded the minimum call length. For a PRI call, the restriction code for the FTS 2000 network (U.S. Federal Government only) is recorded in this field.

TALK (Column 10)

This field must be enabled through system programming and is available in Release 4.2 and later systems only. It applies only to incoming calls directed to Auto Login or Auto Logout calling groups; for all other types of calls, the field is blank or does not appear at all. The time an agent spent talking to a caller is shown in *hh:mm* format. The maximum value is 59:59. Talk timing starts when a call is answered by a calling group agent and ends when either party disconnects. If the agent transfers or parks the call before it is completed, these transitions are included in the elapsed time.

The TALK field displays values as follows:

- The elapsed time of a call while an Auto Login or Auto Logout group member was on the call
- If the caller disconnects before a calling group agent answers, an elapsed time of zero (00:00) is reported, even if the call was answered elsewhere in the system.



NOTE:

By comparing the duration of the call (DUR. field) and the TALK field value for eligible calls, you can determine how long the caller waited, beginning when the call arrived at the system. MERLIN LEGEND Reporter calculates this value, along with others such as the average talk time for agents, to create reports about call center performance.

Considerations and Constraints

Printing system programming reports has a higher priority than printing SMDR reports. SMDR records are generated when the printing of programming reports is completed. Records are also queued if the printer is turned off, disconnected, runs

out of paper, or if a paper jam occurs. Up to 100 SMDR records can be queued. SMDR records generated after maximum capacity is exceeded may be lost because only the newest 100 records are retained.

System time and date must be set correctly to print accurate SMDR reports.

The maximum number of digits recorded in the CALLED NUMBER field is 15.

When the number included in the CALLED NUMBER field contains both an equal access code and a country code for an overseas call, the maximum digits recorded may not provide enough information for call accounting software to process the call and supply cost data. When more than 15 digits are dialed, the CALL TAG field displays a question mark (?) and the first 15 digits are displayed.

Using the programmed Call Report option, call information can be recorded for incoming and outgoing calls (factory setting) or for outgoing calls only. If SMDR is set to record outgoing calls only, an account code cannot be entered for incoming calls. In Release 4.2 and later systems, enabling Talk Time permits recording of incoming calls to Auto Login or Auto Logout calling groups, regardless of the value assigned to the Call Report option.

In Release 4.1 and prior systems, if an incoming call does not satisfy the minimum call length, the call is not recorded on the SMDR report. In Release 4.2 and later systems, enabling Talk Time permits recording of incoming calls to Auto Login or Auto Logout calling groups, even if the call length is less than the programmed minimum number of seconds.

In Release 4.1 and prior systems, call duration timing (DUR. field) begins when an incoming call is answered. In Release 4.2 and later systems, this holds true for incoming calls if the Talk Time option is disabled (the factory setting). In Release 4.2 and later systems with the Talk Time option enabled, timing on incoming calls to Auto Login and Auto Logout calling groups begins when the call is initially detected in the system.

Inside calls are not recorded on SMDR reports.

When a user joins a call on a shared line and continues on the call after the originator drops off, SMDR records the total duration of the call, through the time when the last person hung up.

In Release 4.2 and later systems with Talk Time enabled, if a ringing call to an Auto Login or Auto Logout calling group was picked up by someone in the system and then transferred to and answered by a member of the calling group, an exclamation point (!) appears in the SMDR report's CALL TAG field. If the calling party disconnected before a member answered, an asterisk (*) appears in the CALL TAG field, rather than an exclamation point (!), to indicate an abandoned call.

Features

Station Message Detail Recording (SMDR)

666

In Release 4.2 and later systems with Talk Time enabled, for incoming calls to an Auto Login or Auto Logout calling group, an ampersand (&) in the SMDR report CALL TAG field indicates that an Auto Login or Auto Logout overflow calling group member answered the call. When an incoming call is transferred by an automated attendant to an Auto Login or Auto Logout calling group overflow receiver, the CALL TAG field is left blank, because this is not considered an overflow call. Ineligible overflow receivers include members of Integrated or Generic VMI calling groups.

In Release 4.2 and later systems with Talk Time enabled, the TALK field displays a non-zero duration to indicate the elapsed time of an incoming call arriving on a line assigned to an Auto Login or Auto Logout calling group, starting from when the call is answered by a member and ending when the call is disconnected.

In Release 4.2 and later systems with Talk Time enabled, the TALK field displays a non-zero duration for an incoming call routed by an automated attendant or an operator to an Auto Login or Auto Logout calling group. The value indicates the elapsed time of the call, starting from when the call is answered by a member of an Auto Login or Auto Logout calling group and ending when the call is disconnected.

In Release 4.2 and later systems with Talk Time enabled, the TALK field is left blank for all other incoming and outgoing calls. If the Talk Time option is disabled, the field does not appear on the report.

If a person selects a line and cannot complete the call (for example, due to restrictions), yet remains on the line for more than the programmed call duration, an SMDR record is created, even though a call was never made on that line.

In the event of a power failure, calls are dropped and the SMDR records for those calls are lost.

In Release 2.1 and later systems, an SMDR record is not generated for calls made to loudspeaker paging ports.

Telephone Differences

Queued Call Consoles

When a QCC system operator arranges a three-party conference call (the system operator and two other participants) and presses the Release button, the QCC system operator is released from the call, but the other two participants remain connected. The QCC operator's extension number, however, remains on the SMDR record.

Features

Station Message Detail Recording (SMDR)

667

In Release 4.2 and later systems with Talk Time enabled and the QCC queue assigned as the overflow receiver for an Auto Login or Auto Logout calling group, a caller may disconnect while waiting in the QCC queue. In this case, the TALK field records zero (00:00) and the CALL TAG field includes an asterisk (*) to indicate an abandoned call.

In Release 4.2 and later systems with Talk Time enabled and the QCC queue assigned as the overflow receiver for an Auto Login or Auto Logout calling group, the call may be answered by the QCC operator. In this case, the TALK field records a non-zero duration and the CALL TAG field includes an exclamation point (!) to indicate a call that was handled by someone who was not a group member.

In Release 4.2 and later systems, if a calling group is programmed as the backup for the QCC queue and all QCC operators are temporarily unavailable, an incoming call is sent to the calling group queue to wait for the next available agent. SMDR records this type of call in the same way that it does other incoming calls to Auto Login and Auto Logout calling groups, as long as SMDR has been programmed for this functionality.

Feature Interactions

- Account Code Entry** The account code appears in the ACCOUNT field of the SMDR record. If SMDR is set to record outgoing calls only, an account code cannot be entered on incoming calls. If a remote access barrier code is entered for an incoming call and then an account code is entered, only the account code (not the barrier code ID) appears on the report.
- Authorization Code** If programmed, all outgoing calls over the minimum call length made using an authorization code are recorded in the SMDR record.
- If an account code is not entered, the ACCOUNT field of the SMDR report contains the authorization code used to obtain calling privileges. If an account code is entered at any time during a call, the account code is stored in the SMDR record.
- Auto Dial** Auto Dial calls to outside numbers are recorded by SMDR following the same rules that apply to other outside calls.
- Automatic Route Selection** The CALLED NUMBER field of SMDR reports for systems with ARS shows all digits dialed by the user, including any digits absorbed by the system and the facility used to make the call. The records do not include the ARS dial-out code or any digits added by ARS.

- Basic Rate Interface** The number of a BRI line is shown in the LINE field of the SMDR report. Call timing begins when an outgoing call is answered. Therefore, calls that are unanswered at the far end do not have an SMDR call record.
- In Release 4.1 and prior systems, call timing for incoming calls begins when the call is answered. In Release 4.2 and later systems with the Talk Time option enabled, timing for incoming calls to Auto Login or Auto Logout calling groups begins when the system detects the call.
- Callback and Call Waiting** SMDR begins measuring the duration of callback calls when the line/trunk is seized and the system begins dialing the call.
- In Release 4.1 and prior systems, call-waiting calls are timed as soon as the call is answered.
- In Release 4.2 and later systems with the Talk Time option enabled, timing for incoming calls to Auto Login or Auto Logout calling groups begins when the system detects the call.
- Caller ID** Calling party numbers for incoming calls (including remote access calls) received on a facility with Caller ID are recorded in the SMDR report only if the SMDR report is set for ISDN format.
- Camp-On** If an incoming call is camped on but is not picked up by the other extension, the extension of the user who activated Camp-On is shown in the STN field of the SMDR report. If an incoming call is camped on and picked up by the destination extension, the destination extension is shown in the STN field of the SMDR report.
- Conference** When a conference call includes inside and outside participants, records are generated only for outside participants. When a call is dropped from a conference, it is considered complete and is recorded.
- Coverage** The extension at which an Individual or Group Coverage call is answered is shown on the SMDR report. In Release 4.2 and later systems, when an Auto Login or Auto Logout calling group is assigned as a Group Coverage receiver, calls are reported following the same rules that apply to other incoming calls for the group.
- Forward and Follow Me** If the system is programmed to track both incoming and outgoing calls, two SMDR records are generated when an outside call is forwarded to an outside telephone number. One record shows the incoming call, and the other record shows the call made to the destination telephone number, with the forwarding extension as the originator.
- The Remote Call Forwarding number to which incoming calls are to be forwarded is completed by pressing #. The SMDR report includes the # with the number for calls forwarded to the number. In Release 6.0 and later systems, if a Pause character is included in a Centrex Transfer via Remote Call Forwarding dial sequence, it also appears in the report.

Forward and Follow Me (continued)

In Release 6.0 and later systems, when a call comes into an extension belonging to a principal user and with Centrex Transfer via Remote Call Forwarding activated, the initial incoming call may be of very short duration. You should set the SMDR feature to record 0 (zero) duration calls in order to capture these calls. However, this may not be desirable in all systems.

Group Calling

In Release 4.1 and earlier systems, incoming calls to calling groups are associated with the first extension to answer the call. If an incoming call is answered by a delay announcement device, this extension number is recorded in the SMDR record and is not overridden when the incoming call is answered by a calling group member or its overflow group member. The timing on incoming calls to calling groups begins as soon as the calling group member or delay announcement device answers the call.

In addition, Release 4.2 and later systems with Talk Time enabled provide enhanced information about incoming calls to Auto Login or Auto Logout calling groups, helping system managers assess call center performance. The special characters in the CALL TAG field are described in order of precedence.

- An asterisk (*) indicates an abandoned call. This occurs when the calling party disconnects before a member of an Auto Login or Auto Logout calling group answers, even if the call was answered elsewhere in the system.
- An ampersand (&) indicates an overflow call. If members of an Auto Login or Auto Logout calling group were not available to handle the incoming call, the call was answered by an Auto Login or Auto Logout overflow calling group.
- An exclamation point (!) indicates a call answered by someone other than a group member. This occurs in two situations: when an incoming call on a line assigned to an Auto Login or Auto Logout calling group was answered elsewhere in the system and transferred to and answered by a member of that calling group; or, when an incoming call alerting at the operator was transferred to and answered by someone who was not a member of the calling group. The time that a caller spent waiting to speak to a calling group member may not be optimal.

This data focuses attention on queue time—the elapsed time starting from when the incoming call was detected in the system and ending when the incoming call either was answered by an agent or abandoned by the caller—and may indicate that additional agents are needed to provide the best possible service for an organization's customers.

Features

Station Message Detail Recording (SMDR)

670

**Group Calling
(continued)**

In Release 6.1 and later systems, if a UDP or PSTN call must traverse a tie trunk to reach the auto login and auto logout DGC group, the call will be treated as if it originated on the PSTN and the queue and talk time will be recorded. Any incoming call that traverses PRI private trunks only is treated accordingly because its origination is unknown.

Last Number Dial

Using Last Number Dial, all outside calls exceeding the minimum call length are recorded on the SMDR report.

**Multi-Function
Module**

An MFM is treated as an MLX telephone on SMDR reports.

The system waits until the end of dialing before sending a connect message to the MFM. Any digits dialed after the connect message is received are not recorded on SMDR reports.

Night Service

When Talk Time is enabled in Release 4.2 and later systems and an Auto Login or Auto Logout calling group is assigned to a Night Service group, calls ring first in the calling group and are reported following the same rules that apply to normal operation.

Paging

Paging calls are not reported to SMDR.

Park

If an incoming call was parked but not picked up by the other extension, the extension of the user who activated Park is shown in the STN field of the SMDR record for the call. If an incoming call was parked and picked up by the destination extension, the destination extension is shown in the STN field of the SMDR report.

Pickup

The extension of a person answering a call and using Pickup is shown on the SMDR report. In Release 4.2 and later systems when the Talk Time option is enabled, picked-up Auto Login or Auto Logout calling group calls are reported following the same rules that apply to other incoming calls for Auto Login or Auto Logout calling groups.

Pools

For outgoing calls made by using a pool, the line/trunk selected by the system is reported on the SMDR report.

**Power-Failure
Transfer**

During a commercial power failure, all calls are dropped and no SMDR records are generated for calls made using a power-failure telephone.

**Primary Rate Interface
and T1**

The line/trunk number of a PRI line is shown in the LINE field of the SMDR report. The restriction code for the FTS 2000 network is shown in the ACCOUNT field.

For outgoing calls in releases prior to 2.1, call timing begins when the PRI line is selected. The CALLED NUMBER field shows the number dialed by the user before any digits were manipulated by ARS or PRI tables (Network Selection Table, Special Services Selection Table, or Call-by-Call Services Table). In Release 2.1 and later systems, call timing begins when the call was answered at the far end. Therefore, calls that were not answered are not recorded.

- Recall/Timed Flash** If a multiline telephone user presses the Recall button to get a new dial tone, SMDR timing stops for the previous call and begins for a new call.
- Remote Access** Remote access calls are recorded only if SMDR is programmed to track incoming calls. If a barrier code is entered, the barrier code number (01–16) appears in the ACCOUNT field of the report, preceded by 999999. If the caller uses remote access to dial an extension and the call is answered, the extension number is shown in the STN (station) field. If the call is not answered at the extension, the STN field is blank.
- If no barrier code is required, the ACCOUNT field contains 99999900.
- Beginning with Release 3.0, if the caller provides an invalid or incomplete barrier code for three attempts, either 999999 or 16 zeros are recorded in the ACCOUNT field. If the connection is broken before the third try, the ACCOUNT field contains 999999. If the caller hangs up after the third attempt, but before receiving reorder tone, the ACCOUNT field may contain either 999999 or 16 zeros. If the caller hangs up after the third try and after receiving reorder tone, the ACCOUNT field contains 16 zeros.
- If the caller uses remote access to dial out on a line/trunk, the STN field on the first SMDR record is blank. A second record is created for the outgoing call.
- Saved Number Dial** Using Saved Number Dial, all outside calls exceeding the minimum call length are recorded on the SMDR report.
- Service Observing** In Release 6.1 and later systems, SMDR reports do not record the activity of the Service Observer extension for Service Observing calls.
- Speed Dial** When Personal Speed Dial or System Speed Dial is used to dial an outgoing call, the actual digits dialed by the system appear on the report. However, when a marked System Speed Dial number is used, the System Speed Dial code prints instead of the digits dialed.
- System Access/
Intercom Buttons** When a call is made on a Shared SA button, the SMDR report records the extension number from which the call was made rather than the principal extension number. In Release 4.2 and later systems with the Talk Time option enabled, if an alerting call is answered at an extension with a button for a member of an Auto Login or Auto Logout calling group, it is reported following the same rules that apply to other calls that are answered by non-members.
- Transfer** The number of the extension that hung up on an incoming outside call is shown in the STN field of the SMDR report, regardless of the number of times the call was transferred. For outgoing calls, the number of the extension that dialed the call is shown on the SMDR report, even if the call was later transferred to another extension.

Features

Station Message Detail Recording (SMDR)

672

UDP Features

In Release 6.0 and later systems (Hybrid/PBX mode only), any calls originating on a tandem trunk appear on the SMDR report, as do any calls originating on or passing through the local system.

As with Remote Access calls, SMDR reports may report outside calls using more than one call record. Depending upon how SMDR is programmed and how calls are routed, you may need to consult several SMDR records to trace an outside call that is conveyed over network trunks. Ensure that the system date and time are set accurately on each system that carries these calls. When reviewing reports, keep in mind any time zone differences among networked systems.

If a call travels across a tie trunk connecting two systems to reach the auto login and auto logout calling group, the call is treated as an outside call, and queue time and talk time are recorded. A call traveling across a PRI tandem trunk connecting two systems is treated appropriately as an inside or outside call because its origin is known.

System Access/Intercom Buttons

At a Glance

Users Affected	Telephone users, DLC operators, data users
Reports Affected	Extension Information
Modes	
SA buttons	Hybrid/PBX
ICOM buttons	Key and Behind Switch
Telephones	All except QCC
Programming Codes	
Assign Buttons (centralized telephone programming only)	
Default: Ring	
SA or ICOM	*16
SA or ICOM Originate Only	*18
Shared SA	
Change Button Type (centralized telephone or extension programming)	*17 + primary extension
Ring	**19
Voice	*19
Send Ring (on principal extension for Shared SA)	
On	*15
Off	**15
MLX Display Labels	Centralized telephone programming only, multiline telephones only
Assign Buttons	
SA or ICOM	SysAcc (same for SA or ICOM)
SA or ICOM Originate Only	SysAcc oo (same for SA or ICOM)
Shared SA	ShareSysAcc
Change Button Type	Centralized telephone programming only, multiline telephones only
Ring	
Voice	Voice Annce,Place,Ring [Voice,Place,Ring] Voice Annce,Place,Voice [Voice,Place,Voice]
Maximums	10 SA or ICOM buttons for each extension 27 Shared SA buttons for each multiline telephone 16 Shared SA buttons for each principal extension 3 system users for each call on Shared SA

Factory Settings

Button Assignments by Mode	Hybrid/PBX
Direct-Line Consoles	1 SA Ring 1 SA Voice
Other Multiline Telephones and MFMs	1 SA Ring 1 SA Voice
Single-Line Telephones	1 SA Originate Only 2 SA Ring 1 SA Originate Only
Additional buttons assigned (including Shared SA)	Ring
Ring Timing Option	Immediate Ring
Send Ring (on principal extension)	On

Description

Users access the system by pressing buttons on their telephones. These buttons are called either System Access (SA) or Intercom (ICOM) buttons, depending on the system operating mode. How these buttons operate also depends on the operating mode.

SA Buttons: Hybrid/PBX Mode

In Hybrid/PBX mode, telephones have SA buttons, which are used as follows:

- To make an outside call by dialing an ARS code (usually 9) and a telephone number.
- To make an outside call by using a pool by dialing the pool dial-out code and a telephone number.
- To make an inside call.
- To activate a feature by using a feature code.
- To receive inside and outside calls, including voice-announced inside calls and transferred calls.

An SA button can have one of three attributes:

- **Ring.** Button is used to make and receive inside and outside ringing calls.
- **Voice.** Button is used to make and receive inside and outside calls. An inside call made on this button is a voice-announced call. If the person receiving the call has a speakerphone and it is not already in use or disabled by having Voice Announce turned off, the call arrives on the speakerphone. Both parties hear a beep and the called person hears the caller's voice over the speakerphone. Because voice-announced calls

cannot be made to single-line telephones, a call made on this button to a single-line telephone is a ringing call, even if the single-line telephone has a speakerphone.

- **Originate Only.** Button is used only to make inside and outside calls. Calls are not received on this button. Its purpose is to ensure that a user always has a button available to make or transfer calls, establish conference calls, answer call-waiting calls, or pick up parked calls. The button can be programmed for either Ring or Voice operation for inside calls.

The default attribute for all SA buttons (including Shared SA buttons), after the factory settings by telephone type, is Ring. The factory setting for Automatic Line Selection (ALS) is a sequence of SA buttons. Ringing for all types of SA buttons is set by default to Immediate Ring and can be changed to Delay Ring or No Ring (see [“Ringing Options” on page 618](#)).

Shared SA Buttons: Hybrid/PBX Mode

Each SA button (whether Ring, Voice, or Originate Only) assigned as a factory setting or through centralized telephone programming is identified with a specific extension. To allow two or more telephone users to join in each others' conversations and answer each others' calls, Shared SA (SSA) buttons can be assigned. In a shared arrangement, the SA button identified with the extension is the *principal* (or primary) button. Up to 16 other multiline telephones can have Shared SA buttons corresponding to the principal extension. A telephone can have up to 27 SSA buttons for other extensions but can have only one SSA button for a given principal extension. (One of the first 10 buttons must be an SA button.)

An extension can have all but one of its line buttons as SSA buttons for another extension. That remaining button is reserved for the extension's own SA button. For example, assume that a 10-button telephone at Extension A has its maximum of 10 SA buttons. A 10-button telephone at Extension B can have SSA buttons for up to 9 of Extension A's SA buttons. The remaining button on Extension B is reserved for its own SA button.

The green LED next to a Shared SA button behaves in the same way as it does on the principal extension. When the principal extension or any SSA button corresponding to it is busy on a call, the LED is on at the principal extension and at all Shared SA buttons for that extension. When a call arrives at the principal extension, that extension rings and the LED at its SA button flashes. All telephones with corresponding Shared SA buttons also ring, and the LED at the Shared SA button flashes.

The telephone user at the principal extension can use Send Ring. This feature overrides Delay Ring programmed for any telephones with SSA buttons for the principal extension. When a call arrives for the principal extension while it is busy, the telephones with the Shared SA buttons for that extension ring immediately.

When Do Not Disturb is turned on at the principal extension, calls do not ring at that extension or at other telephones with Shared SA buttons for that extension.

The principal extension or an SSA button can be used to join a conversation in progress. A maximum of three parties can participate in one call.



NOTES:

- SSA buttons cannot be assigned to single-line telephones or other tip/ring equipment connected to a 016 (T/R), 012 (T/R), or 008 OPT module. SSA buttons can be assigned to a tip/ring or external alert device connected either to an MFM in an MLX telephone or to a GPA connected to an analog multiline telephone.
- Shared SA buttons cannot be assigned when the SA button is on a single-line telephone. A single-line telephone cannot be the principal extension for an SSA button unless the telephone is connected to an MFM.

ICOM Buttons: Key and Behind Switch Modes

In Key mode and Behind Switch mode, telephones have ICOM buttons, which are used as follows:

- To dial the Idle Line Access code (usually 9) to select the first idle personal line assigned to the telephone (Key mode only)
- To make an inside call
- To activate a feature by using a feature code
- To receive inside calls, including voice-announced calls, and transferred outside calls

An ICOM button can have one of three attributes:

- **Ring.** Used to make inside ringing calls, to receive inside and transferred outside calls, and to dial the Idle Line Access code to select a personal line.
- **Voice.** Used to make inside voice-announced calls, to receive inside ringing calls, and to dial the Idle Line Access code to select a personal line. If the person receiving an inside call made from this button has a speakerphone and it is not already in use or disabled by having Voice Announce turned off, the call arrives on the speakerphone. Both parties hear a beep and the called person hears the caller's voice over the speakerphone. Because voice-announced calls cannot be made to single-line telephones, a call made on this button to a single-line telephone is a ringing call even if the single-line telephone has a speakerphone.

- **Originate Only.** Used only to make inside calls. Calls are not received on this button. Its purpose is to ensure that a user always has a button available to make or transfer calls, establish conference calls, answer call-waiting calls, or pick up parked calls. The button can be programmed for either Ring or Voice operation.

The default attribute for all ICOM buttons after the factory settings by telephone type is Ring.

In Key mode, the factory setting for Automatic Line Selection (ALS) for multiline telephones is a sequence of outside line buttons. The factory setting for ALS on single-line telephones is an ICOM button.

In Behind Switch mode, the factory setting for ALS for both multiline and single-line telephones is the prime line.

Ringing for all types of ICOM buttons is set by default to Immediate Ring and can be changed to Delay Ring or No Ring (see [“Ringing Options” on page 618](#)).

 **NOTE:**
ICOM buttons are not shared.

Considerations and Constraints

At least one SA or ICOM button must be assigned to each extension in the system.

SA or ICOM buttons can be assigned or removed only through centralized telephone programming.

On a multiline telephone, SA or ICOM buttons can be assigned only on buttons 1 through 10.

Any SA button can be the principal extension for up to 16 Shared SA buttons on other telephones. Any multiline telephone can have up to 28 SA or SSA buttons, at least one of which must be an SA button. No SA buttons may be assigned beyond line button 10, although SSA buttons may be assigned.

The maximum number of system users who can be on a call on an SSA button (including the principal extension) is three.

When a call is received at the principal extension, it rings on the principal extension's SA button, as well as on all corresponding SSA buttons.

SSA buttons cannot be assigned to a single-line telephone. A single-line telephone cannot be the principal extension for a Shared SA button unless the telephone is connected to an MFM.

When two or more users answer the same call on a Shared SA button, the red and green LEDs next to the button go on, but only one person can talk to the caller. Privacy should be used to eliminate competition for the same calls.

Calls received on DID trunks ring on an SA button and on all SSA buttons for the receiving button.

Mode Differences

Hybrid/PBX Mode

SA buttons, including Shared SA buttons, are available only in Hybrid/PBX mode.

Key and Behind Switch Modes

ICOM buttons are available only in Key and Behind Switch modes.

Telephone Differences

Direct-Line Consoles

Each DLC is assigned one SA Ring or ICOM Ring and one SA Voice or ICOM Voice button. Additional SA or ICOM buttons can be assigned to a DLC.

Queued Call Consoles

A QCC, which uses Call buttons, cannot be assigned SA buttons, including SSA buttons. It cannot be assigned ICOM buttons because the QCC is available only in Hybrid/PBX mode.

Other Multiline Telephones

In Hybrid/PBX mode, each multiline telephone (except for a DLC) and Multi-Function Module (MFM) device is automatically assigned one SA Ring, one SA Voice, and one SA Originate Only button.

In Key and Behind Switch modes, each multiline telephone (including a DLC) and MFM device is automatically assigned one ICOM Ring and one ICOM Voice button.

Single-Line Telephones

In Hybrid/PBX mode, each single-line telephone (or other device connected to an 016 (T/R), 012 (T/R), or 008 OPT module; or to a port programmed as tip/ring on a 412 LS-ID-ETR or 016 ETR module) is automatically assigned two SA Ring buttons and one SA Originate Only button.

In Key and Behind Switch modes, each single-line telephone (or other device connected to an 016 (T/R), 012 (T/R), or 008 OPT module; or to a port programmed as tip/ring on a 412 LS-ID-ETR or 016 ETR module) is automatically assigned two ICOM Ring buttons.

In releases prior to 4.0, the default assignment of SA or ICOM buttons to single-line telephones is fixed and cannot be changed—no SA or ICOM buttons can be removed or added. In Release 4.0 and later systems, the default assignment of SA or ICOM buttons can be changed through centralized telephone programming.

A single-line telephone cannot be the principal extension for a Shared SA button, nor can it have SSA buttons unless the telephone is connected to a MFM.

Data/Video Workstations

Shared SA buttons should not be assigned to video workstations.

Feature Interactions

Auto Answer All

When Auto Answer All is activated, incoming calls on SA Ring, ICOM Ring, SA Voice, or ICOM Voice buttons can be answered automatically by the device connected to a General Purpose Adapter (GPA).

If SSA buttons are assigned, they should be programmed for either Delay Ring or No Ring, and the corresponding SA button at the principal extension should be programmed for Immediate Ring. This prevents calls to the principal extension from being answered simultaneously at the principal extension and at another device with a corresponding Shared SA button.

Voice-announced calls received at an analog multiline telephone are not answered by a device connected through a GPA because ringing current is not sent to the device.

Auto Answer Intercom

When the Auto Answer Intercom feature is activated, a Hands-Free Unit (HFU) cannot be used to answer calls on a Shared SA button.

Automatic Line Selection

SA buttons (including Shared SA buttons) or ICOM buttons can be programmed as part of an ALS sequence. You should not interleave different button types (personal line, Pool, SA, or ICOM). For example, in Hybrid/PBX or Key mode, the sequence might include all SA or ICOM buttons first, then Pool, then personal line buttons.

- Automatic Route Selection** When a call is made on a Shared SA button, the ARS FRL that applies is the level programmed for the telephone with the button, not the level for the principal extension.
- Callback** Callback can be used on an SA or ICOM button. When Callback is used on an SSA button, the callback call from the system rings (and the LED next to the button flashes) only at the telephone that originated Callback. If a user other than the person originating Callback selects a Shared SA button with a queued callback request and lifts the handset, the user hears the queuing tone, and the green LED on the originator's telephone goes from flashing to on. If the user hangs up, the green LED on the originator's telephone goes back to flashing and the system directs the callback call to the originator. If the user does not hang up, the system directs the callback call to the user and not to the callback originator.
- Caller ID** Both SA and Shared SA extensions display Caller ID information on Line 1 of the first screen of the display. This information remains on the answering extension's display and is cleared from the other extensions. If another person picks up on that extension, he or she sees *In Use* on the display, and the answering extension shows *Shared Line: Ext Alpha/#* of the other extension on Line 2 of the first display screen. (ETR and MLS display telephones do not show Line 2 information.)
- Calling Restrictions** When a call is made on a Shared SA button, the calling restrictions that apply are those programmed for the extension with the button, not those for the principal extension.
- Call Waiting** A telephone is considered busy when all SA or ICOM buttons (except SA Originate Only or ICOM Originate Only) are in use. The user can dial the Call Waiting feature code to pick up a waiting call only when an SA Originate Only or ICOM Originate Only button is available.
- Conference** Calls on SA, Shared SA, or ICOM buttons can be included in a conference call. If a user involved in a conference call on an SA button also has a Shared SA button for one of the conference participants, the call is active at the SA button, not at the SSA button.
- Coverage** When a Primary Cover, Secondary Cover, or Group Cover button is programmed, a call received on an SA or ICOM button that is eligible for Individual or Group Coverage remains on the sender's SA or ICOM button until it is answered at the receiver's telephone. Once answered by a receiver, the call is removed from the sender's SA (including Shared SA) or ICOM button. When a calling group is programmed as a Group Coverage receiver, however, the call is removed from the sender's telephone as soon as it is sent from the calling group queue to an available member.
- Calls received on Shared SA buttons are not eligible for Individual or Group Coverage.

- Coverage (continued)** If a receiver has a Primary Cover, Secondary Cover, or Group Cover button for a sender and also has a Shared SA button associated with the sender, the green LEDs next to both the Cover button and the Shared SA button flash when a call arrives for the sender. In addition, the red LED stays on at the Shared SA button.
- CTI Link** CTI (Release 5.0 and later systems) allows software applications on a worktop PC to control these features on the SA buttons of an extension using the application: placing a call on hold, retrieving a call from hold, making calls, inside transfer and three-party conference, answering, and hanging up.
- Digital Data Calls** Data calls cannot be presented as voice calls, although users can make data calls using ICOM or SA Voice Announce buttons.
- Display** If a user with a display telephone calls an extension and the call is answered at a Shared SA button, the caller's display shows the principal extension, not the answering extension.
- Do Not Disturb** When Do Not Disturb is turned on at the principal extension, calls do not ring at that extension or at telephones with SSA buttons for the extension.
- Forward and Follow Me** When a telephone user with SSA buttons forwards his or her calls, only calls to his or her extension are affected. Calls ringing on a Shared SA button are not forwarded.
- Group Calling** If a calling group member is busy on a Shared SA button, the principal extension is still considered available.
- If a delay announcement for a calling group is a principal extension that has SSA buttons on other telephones, and if a user uses a corresponding SSA button to join the announcement while a caller is listening to it, the call is removed from the calling group queue and both parties are connected. (The delay announcement is not disconnected until it finishes playing.)
- If a call from the SA button of a user at a principal extension with Shared SA buttons is waiting in the calling group queue, other users cannot use the corresponding SSA buttons to join the call.
- Hold** A call put on hold on an SA or Shared SA button can be picked up at the principal extension or at any telephone with an SSA button for that extension, unless Privacy is turned on at the telephone that put the call on hold. The hold reminder tone is heard only at the telephone that put the call on hold.
- In releases prior to 2.1, a call on hold on a Shared SA button cannot be transferred by the user who picked up the call. In Release 2.1 and later systems, an inside call on hold at an SA button can be picked up and transferred by a user having an SSA button that corresponds to the button with the held call.

Hold <i>(continued)</i>	<p>In Release 2.1 and later systems, a call that has been put on hold at a Cover, SA, Shared SA, or Pool button can be picked up by a user who has a personal line button for the call. When the call is picked up, the green LED next to the personal line lights steadily; however, the call remains on hold at the Cover, SA, SSA, or Pool button.</p> <p>The user who picks up on the personal line cannot transfer the picked-up call. To transfer a call on hold at a Cover, SA, SSA or Pool button, use Pickup instead of picking up on a personal line button.</p>
Last Number Dial	<p>If Last Number Dial is used on a Shared SA button, the number is stored on the telephone that used the feature, not on the principal extension.</p>
Line Request	<p>Line Request cannot be used for an SA or ICOM button.</p>
Messaging	<p>If a Shared SA button is used to leave a message for a display telephone user, the extension of the telephone with the SSA button (not that of the principal extension) is shown in the message. When a principal extension user with an MLX display telephone posts a message and a call is answered at the SSA button, the calling information is cleared from the principal extension. The Home screen on which the posted message is shown, however, is not restored. If the principal extension user presses the Home button or makes or receives a call, the Home screen is restored.</p>
Multi-Function Module	<p>One SA Ring or ICOM Ring button and one SA Originate Only or ICOM Originate Only button should be assigned to a MFM. At least one SA or ICOM button must be assigned to an MFM. Assigning a Shared SA button to an MFM means that the principal extension can join a call that has already been answered by an answering machine connected to the MFM.</p>
Night Service	<p>Night Service calls override any Ring Timing options (Delay Ring or No Ring) programmed for an SA button and ring immediately. On a Shared SA button, however, Night Service calls follow the programmed option (Immediate Ring, Delay Ring, or No Ring).</p>
Paging	<p>Announcements using Speakerphone Paging can be made from a Shared SA button. Users, however, cannot join a page (as they can other calls) on a Shared SA button.</p>
Park	<p>When a user parks a call made or received on an SA button, Shared SA buttons do not ring when the parked call returns.</p>
Personal Lines	<p>When a call on a personal line button is transferred to another user, the call rings on an SA or ICOM button. The LED next to the personal line flashes rapidly to indicate that the call is on hold for transfer. If the call is answered at an SA or ICOM button, the LED next to the personal line lights steadily. If a user shares the personal line appearance and answers the call by using the personal line button, the call is removed from the SA or ICOM button.</p>

Pickup	An inside call ringing at an SA or SSA button can be answered at another telephone. All associated SA or SSA buttons are cleared.
Primary Rate Interface and T1	T1 lines must not be shared between voice and data extensions with Shared SA buttons. The lines are programmed for either voice-only or data-only service.
Privacy	If Privacy is turned on at a telephone with a Shared SA button, other users, including the principal extension and other corresponding SSA buttons, cannot join a conversation on the SSA button. If Privacy is turned on after another user joins the conversation, it does not affect that person, but no additional users can join the conversation.
Recall/Timed Flash	<p>Recall can be used on a ringing or answered inside call made on an SA or ICOM button. When the user is listening to a busy signal, Recall has no effect.</p> <p>On a call at an SA button, either the principal user or another person who has joined the call on a Shared SA button can use the feature. In Release 2.0 and later systems, Recall can be used on an SA button during an outside call made or received on a loop-start line.</p>
Reminder Service	Reminder calls do not ring at SSA buttons.
Ringling Options	<p>Ring Timing options (Immediate Ring, Delay Ring, No Ring) cannot be programmed for SA Originate Only or ICOM Originate Only buttons because they do not ordinarily receive calls.</p> <p>Incoming calls on a Shared SA button ring with the personalized ringing pattern programmed for the telephone with the button (not for the principal extension).</p> <p>The principal extension of Shared SA buttons can use Send Ring. This feature overrides Delay Ring programmed for any telephones with Shared SA buttons for the principal extension. When a call arrives for the principal extension while it is busy, the Shared SA buttons ring immediately.</p>
Saved Number Dial	If Saved Number Dial is used on a Shared SA button, the number is stored on the telephone that used the feature, not on the principal extension.
Service Observing	<p>In Release 6.1 and later systems, bridging takes priority over Service Observing. If another extension bridges onto a call at an observed extension, the Service Observer is dropped.</p> <p>A Service Observing session can be established only when an SA button is available on which to go off-hook. Similarly, a Service Observer cannot receive notification of an observable call if all the SA buttons on his or her telephone are already in use.</p>

Service Observing
(continued)

If a Service Observer goes off-hook on a non-SA button, he or she can post-select to an SA button and establish a Service Observing session. If a Service Observer post-selects while observing an extension, he or she is disconnected from the call.

A Service Observer who pre-selects an SA button can establish a Service Observing session when he or she goes off-hook.

A Service Observer can be off-hook on an SA Originate Only, SA Ring/Voice Option, or SSA button and initiate Service Observing.

Calls made on SA Originate Only and SA Ring/Voice Option buttons can be observed. A call placed or received on an SSA button can be observed.

If a Service Observer is observing a call and there is an SSA button for the SA button the call appears on, the extension with the SSA button cannot bridge onto the call. The SSA button receives the same treatment as if Privacy were active.

SMDR

When a call is made from an SSA button, the SMDR report records the extension from which the call is made, not the principal extension.

Transfer

A transferred call returns only to the telephone that originated the transfer, whether an SA or a Shared SA button.

If a transfer originator has an SSA button for the person receiving the transfer, the LED next to the SSA button flashes to indicate a ringing call. If the transfer originator answers the call, however, it is disconnected.

UDP Features

For Release 6.0 or later systems (Hybrid/PBX mode only), private network trunks can be used to make and receive calls on an SA or SSA button.

System Renumbering

At a Glance

Users Affected	Telephone users, operators, data users
Reports Affected	ARS, Dial Plan, Extension Directory, Extension Information, Group Paging, Operator Information, Remote Access (DISA) Information
Modes	All
Telephones	All
System Programming	<p>Change the 2-digit numbering plan to 3-digit or Set Up Space:</p> <ul style="list-style-type: none"> ■ SysRenumber→Default Numbering→2-Digit/3-Digit/Set-up Space <p>Renumber individual extensions or groups of extensions, calling group extensions, Group Paging extension, pool dial-out codes, operator park zones, LDN extension, remote access code, ARS access code; or assign the range of extensions on a DSS:</p> <ul style="list-style-type: none"> ■ SysRenumber→Single ■ SysRenumber→Block
Maximum	Numbering Range: 0–9950
Factory Settings	
Numbering Plan	2-digit
ARS/Idle Line Access Code	9 (all numbering plans)
Calling Groups	770–791 and 7920–7929 (all numbering plans)
DSS Page 1 button	starts with Extension 0
DSS Page 2 button	starts with Extension 50
DSS Page 3 button	starts with Extension 100
Extra Adjuncts	6850–6992 (2-digit plan)
Extra Extensions	6700–6842 (2-digit plan)
Listed Directory Number	800 (all numbering plans)
MFMs/Terminal Adapters	710–766 (2-digit plan)
Operator	300–499 (3-digit plan)
Paging Groups	0 (not programmable)
Park Zones	793–799 (all numbering plans); 881–888 (operator only)
Pools	
Main Pool	70 (all numbering plans)
Dial-In Tie Trunk	891 (all numbering plans)
Automatic-In Tie Trunk	892 (all numbering plans)
Remote Access Code	889 (all numbering plans)
Extensions	10–66 (2-digit plan); 100–299 (3-digit plan)
Trunks	801–880 (all numbering plans)



NOTE:

In Release 6.0 and later systems (Hybrid/PBX mode only) where local users will dial extensions on a remote networked system, UDP procedures are used to number these extensions so that local users can reach these extensions as though they were on the local system. This section describes only the numbering for local extension numbers. For detailed information about numbering non-local dial plan extensions, see [“Uniform Dial Plan Features” on page 741.](#)

Description

System renumbering is the process of reassigning extension numbers to all types of extensions, adjuncts, lines/trunks, telephones, ranges of extensions on a DSS, ARS, calling groups, Idle Line Access, LDN, paging groups, park zones, pools, and remote access.

When the system is turned on, it identifies the type of module installed in each slot in the control unit and automatically assigns extension numbers. When assigning extension numbers, the system begins with the lowest-numbered slot containing extension jacks and assigns numbers starting with the bottom (lowest) jack and moving consecutively up to the top jack. The system then moves in ascending order to the next slot that contains extension jacks and repeats the process.

The factory default assigns 2-digit extension numbers, starting with Extension 10. Both the number of digits and the extension numbers assigned by the system can be changed to address a company's needs. For example, extension numbers can match room numbers.



NOTE:

If a user needs a specific extension number, it is simpler to connect the user's telephone to the extension jack that is already assigned the requested extension number than it is to renumber the jack where the telephone is connected.

Whenever extension numbers are renumbered, the following must be considered:

- Extension numbers can contain the digits 0 through 9 in any combination, except that no extension number can begin with 0. Zero is a fixed extension number representing the primary system operator. The system also can be programmed to associate 0 with a QCC operator position.
- Extension numbers can contain one to four digits and must be unique. If you renumber an extension number with one or two digits, you cannot use those digits as the leading digits for a longer extension number. For

example, if extension numbers 1, 2, 30, and 40 are assigned to telephones, those numbers cannot be used as the first number in longer extension numbers such as 10, 200, 302, or 4052.

- Whenever an extension number is renumbered, the original extension number is available for use.
- The reserved system-assigned extension numbers (shown in Figures [33](#), [34](#), and [35](#)) must be assigned new extension numbers before the original numbers can be used for anything else.

The system offers three local numbering plans:

- 2-Digit
- 3-Digit
- Set Up Space

Each of the plans allows renumbering of all or selected extensions (single or block). The system numbering plans, with the numbers they automatically assign, are shown in Figures [33](#) through [35](#) and are described in the next three sections.



NOTE:

Figures [33](#) through [35](#) show the default settings in the gray spaces. Extensions can be renumbered to any number shown in the white spaces.

2-Digit Numbering Plan

The 2-digit numbering plan is the factory setting. This plan is designed for companies that do not anticipate a need for more than 50 extensions in the next one or two years.

[Figure 33](#) shows the numbers automatically assigned by the system. The numbers in [Figure 33](#) are arranged in rows according to the first digit. The type of equipment, jack, or feature to which they are assigned is indicated within the row.

0	Operator Console (not flexible) 0				
1	Extensions 10–19				
2	Extensions 20–29				
3	Extensions 30–39				
4	Extensions 40–49				
5	Extensions 50–59				
6	Extensions 60–66	Extra Extensions 6700–6842	6843–6849	Extra MFMs/ Terminal Adapters 6850–6992	6993–6999
7	Main Pool 70	Adjuncts 710–766	767–769	Calling Groups 770–791,7920–7929	Paging Groups 793–799
8	800 ¹	Lines/Trunks 801–880	Park 881–888	889 ²	Pools 890–899
9	ARS Access (Hybrid/PBX Mode)/Idle Line Access 9				

- 1 LDN (QCC Queue)
- 2 Remote Access

Figure 33. 2-Digit Numbering Plan



NOTE:

Extension numbers 0 and 10 both refer to the same operator position in the 2-Digit Numbering Plan.

Each of the first 57 extension jacks defaults to a 2-digit extension number beginning with 10 and ending with 66. The rest of the extensions (extension jacks 67–200) are assigned the 4-digit extension numbers 6700 through 6842.

The extension numbers (710–766) shown for Multi-Function Modules are reserved for MLX extension jacks. These numbers are automatically assigned by the system to adjuncts connected to MLX telephones either using MFMs (such as modems, answering machines, or fax machines) or directly (for example, a terminal adapter). For the first 57 digital extension jacks (numbered 10–66), the extension number assigned to the adjunct is the extension number assigned to the MLX telephone, preceded by a 7. For example, if the extension number assigned to an MLX telephone is 25, the extension number for the MFM adjunct on that telephone is 725. In this example, a call can be made to the telephone by dialing 25, or to the adjunct by dialing 725.

Additional extension jacks are shown in [Figure 33](#) as Extra Extensions (6700–6842), and additional MFMs are shown as Extra Adjuncts (6850–6992). If extra extensions are assigned, the extension numbers for extra adjuncts are assigned by the system to MFM adjuncts. The extension number assigned to the MFM adjunct is the extension number assigned to the MLX telephone, increased by 150. For example, if the extension number assigned to an MLX telephone is 6700, the extension number for the MFM adjunct on that telephone is 6850. In this example, a call can be made to the telephone by dialing 6700, or to the adjunct by dialing 6850.



NOTES:

- The extension numbers are reserved whether or not adjuncts are connected to MLX telephones.

- If you renumber the extension number of an MLX telephone, the system does not automatically change the extension number of the associated adjunct.

- Digital adjuncts that use the system's 2B Data feature use both the adjunct and the main extension number of an MLX extension jack. (See [“Digital Data Calls” on page 223](#) for more information.)

3-Digit Numbering Plan

The 3-digit numbering plan is designed for companies with more than 50 extensions. [Figure 34](#) shows the numbers automatically assigned by the system when you renumber the system using the 3-digit numbering plan.

0	Operator Console (not flexible) 0				
1	Extensions 101–199				
2	Extensions 200–299				
3	MLX Adjuncts 300–399				
4	MLX Adjuncts 400–499				
5	500–599				
6	600–699				
7	Main Pool 70	71–76	Calling Groups 770–791, 7920–7929		Paging Groups 793–799
8	800 ¹	Lines/Trunks 801–880	Park 881–888	889 ²	Pools 890–899
9	ARS Access (Hybrid/PBX mode)/Idle Line Access 9				

1 LDN (QCC Queue)

2 Remote Access

Figure 34. 3-Digit Numbering Plan



NOTE:

Extension numbers 0 and 100 both refer to the same operator position in the 3-digit numbering plan.

Extensions default to 3-digit extension numbers beginning with 100 and ending with 299.

The extension numbers (300–499) shown for adjuncts are reserved for MLX extension jacks. These numbers are automatically assigned by the system to adjuncts connected to MLX telephones either using MFMs (such as modems, answering machines, or fax machines) or directly (for example, a terminal adapter). The extension number assigned to an MFM or direct adjunct is the extension number assigned to the MLX telephone, increased by 200. For example, if the extension number assigned for an MLX telephone is 125, the extension number for the adjunct on that telephone is 325. In this example, a call can be made to the telephone by dialing 125, or to the adjunct by dialing 325.

 **NOTES:**

- The extension numbers are reserved, whether or not adjuncts are connected to MLX telephones.
- If you renumber the extension number of an MLX telephone, the system does not automatically change the extension number of the associated adjunct.
- Digital adjuncts that use the system's 2B Data feature use both the adjunct and the main extension number of an MLX extension jack. (See ["Digital Data Calls" on page 223](#) for more information.)

Set Up Space Numbering Plan

The Set Up Space numbering plan is designed for businesses that want to assign extension numbers that vary in length (one to four digits). Variable-length extension numbers may be more meaningful or more convenient; 1-, 2-, 3-, and 4-digit numbers can be used in the same system. For example, hotels and motels may want extension numbers to match room numbers, and to assign extensions for services (such as Housekeeping or Room Service) to 1-digit extension numbers.

[Figure 35 on page 692](#) shows the numbers automatically assigned by the system when you renumber using the Set Up Space numbering plan. As shown in [Figure 35](#), the system begins reassigning extension numbers with 7100 and ends with 7299. This makes all numbers beginning with 1 through 6 available for use in renumbering. The new numbers can be from one to four digits long.

 **NOTE:**

Extensions 0 and 7100 both refer to the same operator position in the Set Up Space Numbering plan.

The extension numbers (7300–7499) shown for adjuncts are reserved for MLX extension jacks. These numbers are automatically assigned by the system to adjuncts connected to MLX telephones either using MFMs (such as modems, answering machines, or fax machines) or directly (for example, a terminal adapter). The extension number assigned to an MFM or MLX adjunct is the extension number assigned to the MLX telephone increased by 200. For example, if the extension number for an MLX telephone is 7125, the extension number for its MFM adjunct is 7325. In this example, a call can be made to the telephone by dialing 7125, or to the adjunct by dialing 7325.



NOTES:

- The extension numbers are reserved whether or not adjuncts are connected to MLX telephones.
- If you renumber the extension number of an MLX telephone, the system does not automatically change the extension number of the associated adjunct.
- Digital adjuncts that use the system's 2B Data feature use both the adjunct and the main extension number of an MLX extension jack. (See ["Digital Data Calls" on page 223](#) for more information.)

0	Operator Console (not flexible) 0					
1	100–199					
2	200–299					
3	300–399					
4	400–499					
5	500–599					
6	600–699					
7	Main Pool 70	Extensions 7100–7299	MLX Adjuncts 7300–7499	7500–7699	Calling Groups 770–791, 7920–7929	Paging Groups 793–799
8	800 ¹	Lines/Trunks 801–880		Park 881–888	889 ²	Pools 890–899
9	ARS Access (Hybrid/PBX mode)/Idle Line Access 9					

1 LDN (QCC Queue)

2 Remote Access

Figure 35. Set Up Space Numbering Plan

Renumbering Extensions and Lines/Trunks

[Table 42](#) gives a brief overview of the extensions and lines/trunks that can or cannot be renumbered and lists their factory settings.

Single Renumbering

Single Renumbering should be used whenever the extension numbers you are changing *to* or *from* are not sequential.

Single Renumbering can be used to assign a specified extension number to the following: extensions, adjuncts, lines/trunks, telephones, ARS access code, calling groups, Idle Line access code, LDN, paging groups, park zones, pools, and remote access code.

Table 42. Renumbering Extensions

Extensions	Renumbering Yes or No	Factory Settings
ARS Access Code or Idle Line Access Code	Yes	9
Calling Groups	Yes	770–791 and 7920–7929
DSS Page 1 button	Yes	starts with Extension 0
DSS Page 2 button	Yes	starts with Extension 50
DSS Page 3 button	Yes	starts with Extension 100
Extra Adjuncts	Yes	6850–6992 (2-digit plan)
Extra Extensions	Yes	6700–6842 (2-digit plan)
Listed Directory Number ¹	Yes	800
MFMs	Yes	710–766 (2-digit plan)
		300–499 (3-digit plan)
Operator (Primary System or QCC)	No	0
Paging Groups	Yes	793–799
Park Zones	Yes	881–888 (system operator only)
Pool	Yes	Main Pool: 70
		Dial-in Tie Trunk: 891
		Automatic-in Tie Trunk: 892
Remote Access Code	Yes	889
Extensions	Yes	10–66 (2-digit plan)
		100–299 (3-digit plan)
Lines/Trunks	Yes	801–880

¹ In Hybrid/PBX mode, an extension is assigned to the LDN (the published main number) for the QCC queue.

In Release 1.1 and later systems, the system is not forced idle when renumbering extensions, ARS access code, calling groups, Idle Line access code, LDN, paging groups, park zones, pools, and remote access code. In Release 1.1 and later

systems, however, when you are renumbering a line/trunk, the line is forced idle during the renumbering process.

In Release 1.0 systems, when the system manager uses single renumbering to assign a specified extension number, the system is forced idle during the renumbering process.

Block Renumbering

Block renumbering can be used only when the extension numbers you are changing *from* are sequential and the extension numbers you are changing *to* are sequential. Block renumbering can be used to assign extension numbers to a group of extensions, adjuncts, or lines.

When you are renumbering extensions using block renumbering, the system is forced idle during the process.

DSS Renumbering

System renumbering is used to assign the beginning extension number in a *page*. A page is the range of extension numbers that is assigned to a DSS. A single DSS can have three pages of extension numbers, with 50 extension numbers for each page, for a total of 150 extension numbers. When two DSSs are connected, each page's capacity is increased to 100 extension numbers. The two connected DSSs can have three pages of extension numbers, for a total of 300 extension numbers.

Page buttons work as Shift keys on a keyboard. When an operator presses a Page button, he or she selects a page of the DSS, which corresponds to a range of 50 (for a single DSS) or 100 (for two connected DSSs) extension numbers. The factory settings for Page buttons are: the Page 1 button begins with Extension 0, the Page 2 button begins with 50, and the Page 3 button begins with 100.

If two DSSs are attached, the factory setting *must* be changed so that the difference between extensions assigned to the range is at least 100. For example, assign the Page 1 button to begin with Extension 10, the Page 2 button to begin with Extension 110, and the Page 3 button to begin with Extension 210. Page button assignments should be sequential.

The beginning extension number associated with each Page button is the same for all DSSs and cannot be programmed differently for individual operator positions.

Each Page button can be programmed to begin with any extension number in the range of 0 through 9950 that is a multiple of 50. However, to expedite call handling, the assignments should be sequential. The range starting with the lowest extension number should be assigned to Page 1, the range starting with the next higher extension number should be assigned to Page 2, and the range

starting with the highest extension number should be assigned to Page 3. You cannot program individual buttons on a DSS.

Operator park zones must be included in the extension number range specified for one of the Page buttons.

Each of the 50 DSS buttons corresponds to one of three extension numbers. The specific extension number is determined by the Page button that the system operator presses. For example, if the first extension number for the Page 1 button is programmed to be Extension 100, the DSS buttons and associated LEDs on a single DSS correspond to Extensions 100 to 149.

Remote Access Renumbering

The number assigned to a line/trunk can be reprogrammed and used (after appropriate digit deletion and addition) as a remote access code. Users can call in on a line/trunk that has been programmed to supply the remote access code, and reach a system dial tone (barrier code entry should be programmed). From the system dial tone, users can call extensions or calling groups or access a line/trunk to make an outside call (if permitted). See [“Remote Access” on page 602](#) for more information.

Logical IDs

A logical ID is a number that is associated with each connection on the communications system. There is one set of logical IDs for extensions and one set for lines/trunks.

Line/trunk logical IDs start numbering at the first jack of the first line/trunk module in the control unit with the number 1 up to the number 80. For most line/trunk modules there is a one-to-one correspondence between the jack and the logical ID. The exceptions are as follows:

- Each 100D module is assigned 24 logical IDs, although the module has only one physical line/trunk jack.
- Each 800 NI-BRI module is assigned two logical IDs for each physical line/trunk jack, for a total of 16 logical IDs.

For extension modules, another set of logical IDs starts numbering at the first jack of the first extension module in the control unit with the number 1 up to 400. For most extension modules there is a one-to-one correspondence between the jack and the logical ID. The exception is the 008 OPT module, which is assigned 12 logical IDs, although the module has only eight physical extension jacks.

Considerations and Constraints

Extensions do not need to be renumbered in the following cases:

- The default 2-digit extension numbers are acceptable.
- No special extension numbers are needed.
- There are fewer than 50 extensions in the system.

Any extension number except 0 (system operator) can be renumbered. Line/trunk numbers (801–880) can be renumbered.

After an extension is renumbered, the original extension number is available for use. For example, after Extension 32 is renumbered to 40, Extension 32 is available for use.

System renumbering should not be confused with board renumbering, which is used when modules in the control unit are changed. For additional information about board renumbering, see *System Programming*.

When you use system renumbering in Release 2.0 or earlier with Integrated Solution III version 1.0 or 1.1, AUDIX Voice Power erases all messages and greetings for extensions that have been renumbered. This occurs when the automatic reconciliation program runs at 3:00 a.m. The reconciliation program is disabled in Integrated Solution III version 1.2.

Feature Interactions

Authorization Code	Authorization codes are associated with logical IDs, not extension numbers. If extensions are renumbered and the logical IDs for the extensions change, the authorization codes may be reassigned to different extensions.
Automatic Route Selection	In Hybrid/PBX mode, the ARS access code (factory setting is 9) can be renumbered.
CTI Link	When the system dial plan changes, CTI applications (Release 5.0 and later systems) must use the new extension numbers in any requests. The Passageway Telephony Services security database should be updated to reflect permissions for the new extension numbers and to clear permissions for the old ones. Some CTI applications may also require updating.
Direct Station Selector	The beginning extension number for each page is assigned through system programming. The factory settings are as follows: Page 1 button begins with Extension 0, Page 2 button begins with Extension 50, and Page 3 button begins with Extension 100.

Features

System Renumbering

697

Group Calling

Extensions for calling groups (factory settings 770–791 and 7920–7929) are assigned and can be renumbered through system renumbering.

Ringling/Idle Line Preference

In Key and Behind Switch modes, the Idle Line Access code (factory setting is 9) can be renumbered.

UDP Features

In Release 6.0 or later systems (Hybrid/PBX mode only), a separate numbering plan is provided for non-local dial plan extensions, allowing system managers to enter the ranges of extensions on remote systems. These ranges are associated with patterns that in turn allow routing over private tandem trunks or over PSTN facilities when appropriate. These ranges must be unique and unambiguous in the local dial plan. Programming remote extension ranges does not affect the remote system or the extension numbering used within the remote system. When a system is renumbered to the factory-set default, non-local dial plan extension ranges are deleted.

If the dial plan of a remote system in the network changes, the system administrator must determine the impact on all systems in the private network. Changes to the non-local dial plan must be made manually at each system.

Features
Timed Flash

698

Timed Flash

See [“Recall/Timed Flash” on page 590.](#)

Tandem Switching

At a Glance

Users Affected	All
Reports Affected	General Trunk Information, Extension Information
Modes	Hybrid/PBX
Telephones	All
System Programming	<p>Specify the switch type for a PRI tandem trunk connected to a slot in the control unit:</p> <ul style="list-style-type: none"> ■ LinesTrunks→PRI→SwitchType→Dial slot no.→Enter→Specify switch type→Enter→Exit→Exit <p>Specify switch identifiers for a block of tandem facilities:</p> <ul style="list-style-type: none"> ■ LinesTrunks→More→UDP→SwNum-Block→Dial starting trunk in block→Enter→Dial ending trunk in block→Dial switch no.→Enter→Exit→Exit→Exit <p>Specify a switch identifier for a single tandem facility:</p> <ul style="list-style-type: none"> ■ LinesTrunks→More→UDP→SwNum-Single→Dial trunk no.→Enter→Dial switch no.→Enter→Exit→Exit→Exit <p>To delete an identifier for one trunk:</p> <ul style="list-style-type: none"> ■ LinesTrunks→More→UDP→SwNum-Single→Dial trunk no.→Delete→Exit→Exit→Exit <p>To delete an identifier for a block of trunks:</p> <ul style="list-style-type: none"> ■ LinesTrunks→More→UDP→SwNum-Block→Dial starting trunk in block→Enter→Dial ending trunk in block→Delete→Exit→Exit→Exit
Maximums	
Switch identifier numbers	<p>No value = not connected to a networked switch; 1–20 = trunk connected to a non-satellite MERLIN LEGEND Communications System more than 200 miles away; 21–40 = trunk connected to a satellite MERLIN LEGEND Communications System less than 200 miles away; 41–50 = trunk connected to a non-satellite non-LEGEND system, for example, a DEFINITY ECS or DEFINITY ProLogix Solutions system, that is more than 200 miles away; 51–60 = trunk connected to a satellite non-MERLIN LEGEND System, for example, a DEFINITY ECS or DEFINITY ProLogix Solutions system, that is less that 200 miles away</p>

Factory Settings

Switch Identifier	No value; facility not networked
PRI Tandem Trunks ¹	
Network Service	Electronic Tandem Network (ETN)
Routing	Route directly to UDP
Copy Telephone No. to Send	Copy

¹ Release 6.0 and later systems only: when the switch type is set to LEGEND-Ntwk or LEGEND-PBX, these settings are made automatically and cannot be changed unless the switch type is changed. You can add or remove B-channels from the assigned B-channel group.

Description



NOTES:

- This topic only summarizes information about private networks. Detailed information is included in the *Network Reference*.
- DEFINITY ECS and DEFINITY ProLogix Solutions features and operations are beyond the scope of this guide. This book discusses the network from the MERLIN LEGEND Communications Systems' perspective.
- When a network consists of more than two systems, a coordinating system manager should act as a coordinator for all changes to network systems dial plans, non-local dial plans, ARS routing, UDP routing, and remote access. Otherwise, the two system managers should plan together and agree upon any changes that are made subsequently.

In Release 6.0 and later systems (Hybrid/PBX mode only), MERLIN LEGEND Communications Systems can be networked with one another or with DEFINITY ECS or DEFINITY ProLogix Solutions communications systems in private networks. In previous releases, this functionality is available using tie lines, but Release 6.0 provides enhanced functionality. Tandem switching permits a system to route an outside call over a facility that carries the call outside the local system, rather than routing it to an extension connected to the system. Delay-start (T1-emulated voice and/or data, or analog) tie trunks or PRI facilities can act as *tandem trunks* to connect networked systems.

This section describes how line/trunk operations are set up and used for optimal cost savings and functionality across private networks, including the following topics:

- Switch identifiers
- ARS access to lines/trunks on remote networked systems

- Remote access settings to allow network routing
- Feature interactions with line/trunk features such as pools and PRI

[“Uniform Dial Plan Features” on page 741](#) describes how the system is set up and used for one aspect of private networks: non-local dial plan extensions, including the following topics:

- Intersystem calling between extensions located at different systems in a private network
- Details of UDP routing for intersystem calls and other routed calls
- Feature interactions across private networks

Tandem switching offers the following features and benefits:

- **Toll Savings.** Private networked trunks allow you to realize cost savings on long-distance and toll calls in the two following ways:
 - Callers on a local system can use ARS to reach the public switched telephone network via outside trunks connected to networked remote systems, decreasing the cost of toll calls. No special dialing is required. See [“Automatic Route Selection \(ARS\), Uniform Dial Plan Routing, and Remote Access” on page 703](#) for details.
 - In addition, organizations can use private networked trunks to make calls between networked systems, which may be geographically distant from one another. For details about this functionality, see [“Uniform Dial Plan Features” on page 741](#).
- **Service Cost Savings.** There are two ways that organizations can save on costs incurred from service providers:
 - Customers order a point-to-point T1 facility from a service provider, then use system programming to set it up for tandem PRI or tandem T1 services. As necessary, a service provider can provide amplification for these digital tandem trunks, but does not supply switching services.
 - Release 6.0 and later systems support fractional use of PRI and T1 facilities through drop-and-insert equipment placed between networked systems that tandem trunks connect. This technique is often used to provide 2B data services on the dropped channels or B-channels, while reserving the remaining lines for voice traffic. All T1 channels (emulated tie and Switched 56 data) and PRI B-channels must still be programmed and all do count towards the system maximum of 80 lines. To learn more about using and setting up T1 and PRI tandem trunks, refer to [“Primary Rate Interface \(PRI\) and T1” on page 509](#).

- **Shared Applications.** Networked systems should have their own local voice mail and/or auto attendant applications as well as their own external alerts and Music-On-Hold sources. A single Auto Attendant, however, can distribute calls throughout the network. It can answer only those calls that arrive on the PSTN trunks of the system where it is connected.

Although many features are available using tie trunks for network connectivity, PRI tandem trunks provide greatly enhanced features and speed. For this reason, PRI is recommended over tie (T1-emulated voice and data or analog) for private networks.

To correctly set up systems for transparent calling among non-local dial plan extensions, the system manager first assigns networking tandem trunks to pools. For more information, see [“Pools” on page 500](#). For additional details about setting up PRI and T1 tandem trunks, see [“Primary Rate Interface \(PRI\) and T1” on page 509](#).

In order to realize the cost savings afforded by tandem switching, system managers must first label networked tandem trunks with switch identifiers, described in the next section.

Switch Identifiers

Switch identifiers designate, for each networked trunk, the system connected at the other end of the that trunk. The system manager must program switch identifiers to assure proper volume levels on private network trunks and to allow proper routing for calls across the network.

The correct switch identifier for a trunk or block of trunks is determined by the type of switch to which the trunk is connected and whether or not that switch is a *satellite* switch (located within 200 miles of the local system). It is important to know the distance between systems in order to assure transmission quality. The identifiers are switch numbers that have the following meanings:

- Unassigned, no value = trunk connected to central office.
- 1–20 = trunk connected to a non-satellite MERLIN LEGEND Communications System.
- 21–40 = trunk connected to a satellite MERLIN LEGEND Communications System.
- 41–50 = trunk connected to a non-satellite system that is not a MERLIN LEGEND Communications System (for example, a DEFINITY ECS).
- 51–60 = trunk connected to a satellite system that is not a MERLIN LEGEND Communications System (for example, a DEFINITY ProLogix Solutions communications system).

A MERLIN LEGEND Communications System is always identified by a number between 1 and 40, whereas DEFINITY ECS or DEFINITY ProLogix Solutions systems are identified by numbers between 41 and 60.

A switch identifier should be unique across a network. This helps avoid a situation called *automatic immediate cycling*. For example, when the switch identifiers for the incoming trunks and the automatically selected outgoing trunks for a call match indicating the tandem call would return to the originating switch, another route for the call is selected if possible. If all available routes specify systems with matching switch identifiers, however, the caller hears a fast-busy tone. The call is routed to the destination system and then back to the originating system in a continuous loop, until all available trunks are used.

Once switch identifiers are assigned, the system can be set up for proper routing among networked systems. The next topic provides general descriptions of the steps involved.

Automatic Route Selection (ARS), Uniform Dial Plan Routing, and Remote Access

Tandem switching allows network system users to use ARS calls that are carried on private network trunks to non-local systems where they are routed out over public switched telephone network facilities. At the non-local systems to which or through which calls are routed, the calls are received as remote-access calls, even though the callers dial normally without using a remote access code. When an ARS call arrives at a networked system, ARS routes the call cost-effectively either over local lines/trunks accessing the public switched telephone network or over tandem trunks that connect to another networked system.

For example, an organization might have a main office in Boston and subsidiary offices in New Jersey and New York, connected by networked private tandem trunks that link three MERLIN LEGEND Communications Systems. A user in the New Jersey office who wishes to make an outside call to the 617 area code (Boston) can do so through a line/trunk connected to the system in Boston. To accomplish this, ARS routes the call from New Jersey over tandem trunks, first to the New York system and then to the Boston system. Remote Access features are used at the New York system, through which the call is routed, and at the Boston system, where the outgoing call is sent to the public switched telephone network. The caller does not dial a remote access code. For example, a user might dial, 916175551211.

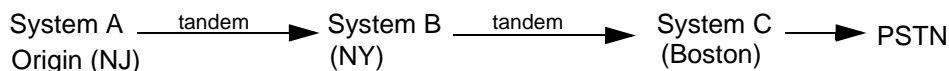

This section discusses the general steps for setting up ARS and Remote Access at the system where calls originate, at any intervening systems, and at the system

where the calls are connected to the public switched telephone network. It includes the following two topics:

- **Local Calls Routed to Other Systems.** This topic explains the factors that you must consider when you set up your local system so that your users can make ARS calls via public switched telephone network trunks connected to another networked system.
- **Network Calls Routed via the Local System.** This topic explains the factors that you must consider when remote users, calling via ARS from a networked system, use public switched telephone network facilities connected to your own local system and/or have calls routed through your system to another system where they are sent to the PSTN.

[“Automatic Route Selection” on page 77](#) and [“Remote Access” on page 602](#) provide additional general information about these features.

Local Calls Routed to Other Systems

Local system users may use ARS to route calls over tandem trunks to the PSTN facilities connected to a non-local system.

This arrangement can provide toll cost savings when users need to reach outside numbers that are *not* in their own local calling area but *are* local to other systems in a network. It also means that in some cases, a MERLIN LEGEND Communications System may have only one or two PSTN trunks connected to it for emergency purposes only. Under normal circumstances, the system uses PSTN facilities connected to another system in the network, which can provide call-volume advantages when buying PSTN services such as domestic long-distance calling.



NOTE:

For intersystem calls among network extensions and for routing of DID and PRI dial-plan routed calls that are sent across the network, UDP routing is used. It is much like ARS routing, only simpler. Details are provided in [“Uniform Dial Plan Features” on page 741](#).

To accommodate certain types of calls, enhance security, and make system programming simpler, the systems in a network should all use the same ARS access code. This code then cannot be included in the non-local dial plan of any networked system, because system programming of the local ARS access code into the non-local dial plan is blocked. If ARS access codes are not all the same, great care must be taken not to program a non-local ARS access code into the non-local dial plan. For example, if the ARS access code is 9, extension ranges such as 9000–9050 should not be programmed. Programming the ARS access code into the non-local dial plan can allow inadvertent access to ARS on a remote system.

For detailed information on modifying ARS in order to allow calling out on PSTN facilities connected to a non-local system in a network, refer to the *Network Reference*. The general rules are listed below:

- Assign tandem trunks to a pool or pools including only one type of trunk (PRI, T1-emulated tie programmed for voice and/or data, or analog tie). For information about assigning trunks to pools, see [“Pools” on page 500](#).

For 10xxx and 101xxx equal access Interexchange Carrier (IXC), Dial 0, and N11 calls from a collocated networked system that is not connected to the PSTN, the tandem trunks must be assigned to the main pool so that these calls can be routed across the network to another system's public switched telephone network PSTN trunks. For equal access calls, the system automatically prepends the local ARS access code, which *must* match the ARS code of the non-local system.

**CAUTION:**

Unless networked systems are collocated, each system should have at least one loop-start line connected to the PSTN. The line is required to allow connection of a power-failure telephone to the Power-Failure Transfer (PFT) jack on a module as a power outage backup and for correct routing of emergency and other N11 calls. To ensure that the correct services are reached, if the loop-start line is used for emergency or other N11 calls, it should be assigned to the main pool. In this case, IXC calls determine the number of loop-starts required. Refer to the Feature Reference guide for details on the PFT feature.

- At the system where calls originate, use one or more ARS tables for routing network calls. The type of table required depends upon how users in your system will employ networked lines. Typically, you might need an Area Code table. For example, if the remote system is in the 617 area code and your local system is in the 908 area code, the Area Code Table that you set up might include the entry 617.

All tables that specify tandem trunk pools must prefix the ARS access code of the remote system.

For all fully programmable ARS tables, ARS tables 17 & 18, Dial 0 table, and Special Numbers table, the Remote Access code must not be programmed in the prepended digits attributes table of each table.

At the system where calls are delivered to the PSTN, digit manipulation may also be required. In the example above where calls are routed from the 908 area code to the 617 area code, the system in the 617 area code absorbs 1617. ARS tables can be used, under some circumstances, to send calls to yet another networked system. It may be necessary to add or absorb digits for further routing. For more information refer to the *Network Reference*.

- At the system where calls originate, set up the subpatterns for the table. In doing so, you may wish to check with the non-local system manager to ensure that the local system routes associated with the primary time period (sub-pattern A) take advantage of non-local system routes associated with the secondary time period (sub-pattern B). If the non-local system is in a different time zone from your own, you may need to take this into consideration as well. For more information refer to the *Network Reference*.
- At the system where calls originate, assign appropriate FRLs to the routes and to the extensions that will use the networked lines. Factory settings do not restrict toll calls. At the system where calls reach the PSTN, assign an FRL to the default COR for the type of tandem trunk (non-tie for PRI and tie for all others). See [“Restrictions” on page 88](#) in the ARS topic and [“Uniform Dial Plan Features” on page 741](#). For more information refer to the *Network Reference*.

FRLs are assigned to extensions. These FRLs apply not only to ARS but to non-local UDP routing as well. Plan UDP, ARS, and extension FRLs carefully so that extension users can reach non-local extensions as needed and still be subject to required limitations on toll calling. For more information about UDP routing, see [“Uniform Dial Plan Features” on page 741](#). For more information refer to the *Network Reference*.

- Assign absorbed and other (prepended) digits as required by ARS at each switch. The local ARS feature must prepend the ARS access code of the remote system.

Network Calls Routed via the Local System

When non-local users access ARS to dial out over PSTN facilities connected to your local system or to another system connected to yours, your system uses a special form of the Remote Access feature to accommodate these calls. Because calls are routed from one system to one or more other systems, the remote access settings for this purpose are distinct from the Remote Access feature used by individuals who enter a barrier code in order to reach an extension or place an outgoing call on the system.

Non-local users who access your PSTN trunks via ARS and private network trunks do not dial a remote-access barrier code. For security purposes, the system applies the default COR calling restrictions that you assign to all tie (T1-emulated voice or data, or analog) or non-tie (PRI) trunks, ignoring the barrier code requirement setting. If remote users connect to your system via tandem PRI facilities, the non-tie restrictions apply; otherwise, the tie restrictions apply. Non-tie restrictions apply to tandem PRI trunks only, and tie restrictions apply to tandem tie trunks only. You can program both types of COR if needed, using the following system programming procedure (refer to *System Programming* for detailed instructions).

SYS PROGRAM→LINES/TRUNK→REMOTE ACCESS→NONTIE/
TIELINES→RESTRICTIONS

When programming the default COR, change the Calling Restriction option to unrestricted (the factory setting is outward restricted). You should assign Disallowed List 7 to include; 900, 976, and other types of calls that users should not be allowed to call. When a call is received at a non-local system that routes it to another network system, the FRL assigned to the default COR is compared to the local UDP or ARS route FRL to permit or forbid the routing of the call. For a call to go through, the route FRL must be equal to or less than the default COR FRL.



SECURITY ALERT:

Networked systems require special attention to security issues. Follow the rules below when setting up and planning your system for network use.

- *Ensure that barrier codes are required for incoming remote access calls received on PSTN PRI dial-plan routed and DID facilities, as well as those calls that are made from the local system by dialing the Remote Access code (889, for example). When you program the default COR, turn the barrier code requirement on. This setting is ignored for ARS calls and calls to non-local extensions across the network. It is still applied to DID and PRI dial-plan routed remote access calls, however, as well as to calls received on a tandem trunk and routed to a Remote Access code. Because the COR Calling Restriction must be set to unrestricted for network calling, using barrier codes on these facilities is essential in order to apply security measures. When a Remote Access code is included in the non-local dial plan of the calling system, the caller's barrier code FRL on the called system is compared to the UDP or ARS route FRL on the called system. See ["Class of Restrictions \(COR\)" on page 610](#) for details.*
- *Extension and ARS FRLs should be carefully and stringently assigned in order to prevent unauthorized trunk-to-trunk transfers to local PSTN facilities.*

To implement this operation where ARS calls are routed to or via your system, consult *System Programming* and ["Class of Restrictions \(COR\)" on page 610](#) in the section about remote access.

The following general steps outline the procedures:

- Do not assign the private trunks for remote networked users to remote access.
- Set the options listed below for the remote access default COR on your system. If your system is linked to the private network by tandem tie facilities (analog, T1-emulated voice and/or data), assign the settings to all tie trunks. If only tandem PRI trunks link your system to the private network, assign the settings to all non-tie trunks. If both tandem tie and tandem PRI trunks link your system to the private network, assign the remote access default CORs to their respective types of trunks.
 - In a network, this setting should be turned on in order to require barrier code entry on calls that arrive from the PSTN over DID or PRI dial-plan routed facilities or that are made by dialing a Remote Access code included in the non-local dial plan. When barrier codes are not required, the remaining default COR settings apply to PSTN calls as well as network calls. This poses a security risk and does not allow adequate protection against toll fraud. The barrier code requirement is ignored for calls on tandem trunks, but the remaining default COR setting does apply to such calls.
 - This setting determines whether local and/or toll calls are allowed. The factory setting is outward- and toll-restricted. To allow call routing to the PSTN or to another system in the network, this setting should be changed to unrestricted, allowing the routing of all such calls.
 - Use this FRL setting by assigning a restriction level from 0 to 6, 0 is the most restrictive, and 6 is the least restrictive. The FRL value assigned here is the opposite of the FRL value assigned to an ARS route, where a value of 0 is the least restrictive, and a value of 6 is the most restrictive. The factory setting is 3. To restrict calls from using selected UDP or ARS routes, assign a value that is lower than the FRL assigned to the route. Network call routes (UDP or ARS) use this default COR FRL and do not use barrier codes. As long as you require barrier codes for the default COR setting, the barrier code FRL and not the default COR FRL, is applied to remote access calls that arrive on PSTN dial-plan routed PRI facilities or on DID trunks or that are made by dialing a Remote Access code included in the non-local dial plan.
 - Do not assign any Allowed Lists.
 - Disallowed Lists should be used for the default COR. You should use Disallowed List 7, which prohibits a variety of calls often made by toll fraud abusers. Review and add to this list as needed. When a Disallowed List is assigned, ARS calls cannot reach the specific

numbers included on the list. When barrier codes are required for the default COR, Disallowed Lists should be assigned to individual barrier codes.

- Modify ARS as required. Using the example outlined earlier, a remote user might dial the 617 area code preceded by a 1. If the call would be routed as a local call on your local system, the digits 1617 would be absorbed. If not, they might be retained and then absorbed by a networked system connected to your own and located in the 617 area code. For additional information, see *System Programming* and [“Automatic Route Selection” on page 77](#). For more information refer to the *Network Reference*.

Feature Interactions

Allowed/ Disallowed Lists

Disallowed Lists should be used for the default COR. You should use Disallowed List 7, which prohibits a variety of calls often made by toll fraud abusers. Review and add to this list as needed. When a Disallowed List is assigned, ARS calls cannot reach the specific numbers included on the list. When barrier codes are required for the default COR, Disallowed Lists should be assigned to individual barrier codes.

Automatic Route Selection

In Release 6.0 and later systems (Hybrid/PBX mode only), the ARS access code is accepted over private networked trunks, allowing users in a local system to make calls from lines/trunks connected to a remote system. The system manager programs ARS in order to direct calls over the most cost-effective routes; calls that are local, for example, at a remote networked switch, can be sent out from lines/trunks connected to that system. At the remote system, Remote Access features are used to accept such a call.

Do not program a remote system's ARS access code into the local system non-local dial plan. For example, if the ARS access code is 9, do not include a range of extensions that begins with 9. If you attempt to program the local ARS access code into the non-local dial plan, the system blocks the attempt. For security and convenience, it is best if all systems in a network use the same ARS access code.

Because equal access (IXC or Interexchange) calls from a system with no PSTN trunks require that local and remote ARS access codes match, the local ARS access code is automatically prefixed when these calls are sent to a networked system. You should not use this arrangement unless networked systems are collocated. Otherwise, Dial 0 and Special Number calls (911 calls, for example) do not reach the correct local services.

Callback

Callback queuing works for lines/trunks connected to the caller's local system, including private network tandem trunks. When a call is sent across the network and a non-local system's trunks are busy, the caller cannot queue the call using Callback.

- Callback**
(continued)
- If a caller attempts Selective Callback upon hearing a busy tone and the busy condition is not derived from the originating system, Selective Callback has no effect. A caller can use Selective Callback to queue for Route 1 when all local routes for a networked call are busy.
- CTI Link**
- In Release 6.0 and later systems (Hybrid/PBX mode only), operation for non-local dial plan extension calls, both incoming and outgoing, in PassageWay Telephony Services applications depends upon the application implementation as well as the type of private networked trunk (PRI or tie) that carries calls. See [“Private Network Operation \(Release 6.0 and Later Systems Only\)” on page 217](#) for details.
- Digital Data Calls**
- In Release 6.0 and later systems (Hybrid/PBX mode only), digital data calls between networked systems must travel over PRI tandem trunks or T1-emulated tie data tandem trunks. 2B data is supported when two B-channels or T1 channels are available. Digital data calls can take place at 64- and 128-kbps data speeds over tandem PRI trunks that are routed for data-only or voice/data operation. T1-emulated tie data tandem facilities are UDP-routed for data only; 56- and 112-kbps data speeds are supported on these facilities.
- Night Service**
- In Release 6.0 and later systems (Hybrid/PBX mode only), if Night Service is programmed with outward restriction, the restriction does not apply to non-local dial plan calls. Exclusion lists apply only to the local system's extensions and do not apply to UDP calls.
- Transitions into and out of Night Service must be made locally. For example, an operator cannot turn on Night Service at a remote system.
- During Night Service operation, a user can call into a shared remote access trunk and use remote access to reach non-local extensions.
- During Night Service operation, an intersystem call to a member of a Night Service group rings at all member extensions.
- Transitions into and out of Night Service must be made locally. For example, an operator cannot turn on Night Service at a remote system.
- Private trunks should not be assigned to a Night Service group.
- Personal Lines**
- To avoid toll fraud, private networked trunks must not be assigned to extensions as personal lines.
- Pools**
- All private trunks must be assigned to pools of trunks that are of the same type (PRI, analog tie, T1-emulated tie voice, or T1-emulated tie data). For security reasons, dial access and Pool button access to these pools should not be permitted.
- Pool Status buttons show the busy or not-busy status of private trunk pools as well as outside trunk pools.
- When PRI tandem trunks are available, their pools should be assigned as Route 1 for the purpose of UDP routing.

Primary Rate Interface (PRI) and T1

In Release 6.0 and later systems (Hybrid/PBX mode only), PRI and T1 (emulated tie voice or data tie) facilities can be private tandem trunks. To provide the facility, customers order a point-to-point T1 circuit from a service provider and use system programming to set it up for PRI or T1, but the provider only supplies amplification, not switching services.

When system programming of the DS1 switch type labels a PRI facility as a tandem trunk, the system selects an unused B-channel group (beginning with Group 80 and counting backward) and assigns all the B-channels to it. This programming can be changed after the initial assignment.

Drop-and-insert equipment can be placed between systems connected by tandem PRI or T1 trunks to provide fractional service. All channels still count towards the 80-line system maximum and the PRI D-channel must never be dropped.

PRI and T1 tandem trunks require the same initial DS1 programming (clock synchronization, framing format, and so on) that other such facilities do. For PRI facilities, however, routing, network service, and copy telephone number settings are programmed automatically by the system and cannot be changed unless the switch type is modified first.

When a call arrives on a dial-plan routed PRI facility and its digits match an extension on the non-local dial plan, the call is routed to the appropriate remote extension.

Remote Access

Remote access allows non-local network users to access trunks connected to the public switched telephone network, permitting cost savings. Barrier codes are not used for this application of tandem trunks. Instead, default tie and/or non-tie COR permissions and restrictions are used, depending on whether private network trunks are tie trunks or PRI facilities.

A caller can reach remote access on a networked system by calling in on DID, PRI dial-plan routed, or dial-in tie trunks or by dialing a remote access code programmed into the non-local dial plan. The remote system applies any required restrictions. The barrier code requirement for the default COR should be turned on.

A remote access caller can call a number in the non-local dial plan

Voice Messaging Interface (VMI)

In most cases, each system in a private network should have its own voice mail/auto attendant application. When a single system includes both an auto attendant and all public switched telephone network trunks that call into the application, the auto attendant application can direct calls to non-local dial plan extensions.

Timer

At a Glance

Users Affected	Telephone users, operators
Reports Affected	None
Modes	All
Telephones	MLX display and analog multiline telephone users
MLX Display Label	Timer [Timer]

Description

Each MLX telephone and analog multiline display telephone has a timer to time calls, meetings, breaks, or other events. When activated, the timer appears at the top of the display, next to the date, and starts counting. It counts to 59 minutes and 59 seconds, then resets to zero and continues counting.

MLX Display Telephones

To start the timer on an MLX display telephone:

1. Press the Menu button.
2. Select `Timer`. If this feature is not displayed, press the More button. The display returns to the Home screen, and the timer starts counting automatically.

To stop the timer on an MLX display telephone:

1. Press the Menu button.
2. Select `Timer`. If this feature is not displayed, press the More button. The display returns to the Home screen, and the timer is no longer displayed.

Analog Multiline Display Telephones

To use the timer on an analog multiline display telephone:

1. Press the Time/Timer button.
2. Press the Start button to reset timer. The timer starts counting at 00:00.

3. When finished timing, press the Stop button.
The timer stops counting.
4. Press Time/Timer to return to normal display.



NOTE:

If timing a call, the timer does not stop automatically when the call is completed.

Toll Type

At a Glance

Users Affected	Telephone users, operators, data users
Reports Affected	General Trunk Information
Modes	All
Telephone	All
System Programming	Designate whether or not a toll prefix is required: ■ LinesTrunks→Toll Type
Factory Setting	Toll prefix required

Description

The Toll Type setting allows the system to classify calls as either local or toll, based on the number a user dials. The factory setting for Toll Type requires a user to dial a toll prefix (1 or 0) before dialing the area code and telephone number for a toll call. In some areas, a toll prefix is not necessary. The factory setting for Toll Type can be changed to specify that no toll prefix is required for these types of lines/trunks.

Dialing a prefix depends on local telephone company requirements and the type of line/trunk being used.

Considerations and Constraints

Toll Type does not apply to tie trunks or DID trunks. The local telephone company must be consulted to determine which of the system's lines/trunks require a toll prefix.

Mode Differences

Hybrid/PBX Mode

Systems in Hybrid/PBX mode with ARS always require a user to dial 1 before dialing a 10-digit toll call. Some 7-digit numbers may require dialing 1 as well.

Feature Interactions

Automatic Route Selection

In certain areas, the local telephone company requires dialing the prefix 1 for certain exchanges. In these cases, the exchanges can be assigned to a 1 + 7 ARS table, and the 1 + 7 Dial setting must be set to Within Area Code. This dialing requirement is not related to toll type.

Allowed/Disallowed Lists

When lines/trunks with different toll types are connected to the system (for example, basic lines/trunks and PRI facilities), a toll prefix (0 or 1) may be required for toll calls on some lines/trunks but not on others. In this case, two Disallowed List entries are required to restrict users from dialing specific area codes and/or telephone numbers. For example, to restrict users from dialing calls in the 505 area code on both toll types, one entry must be 1505 and the other entry must be 505. When the Disallowed List is assigned to an extension, the 505 entry restricts users from making calls to the 505 area code on lines/trunks that do not require a toll prefix, and the 1505 entry restricts users from making calls (including local calls) to the 505 area code on lines/trunks that do require a toll prefix. The same rules apply to Allowed Lists.

Touch-Tone or Rotary Signaling

At a Glance

Users Affected	Telephone users, operators
Reports Affected	DID Trunk Information, GS/LS Trunk Information, System Information (SysSet-up), Tie Trunk Information
Modes	All
Telephones	All
System Programming	<p>Line Programming for Touch-tone or Rotary Service</p> <p>Change individual line/trunk to rotary or touch-tone service:</p> <ul style="list-style-type: none"> ■ LinesTrunks→TT/LS Disc→Outmode <p>Change individual tie trunk to rotary or touch-tone service:</p> <ul style="list-style-type: none"> ■ LinesTrunks→TIE Lines→Inmode <p>Change individual tie trunk to rotary or touch-tone service:</p> <ul style="list-style-type: none"> ■ LinesTrunks→TIE Lines→Outmode <p>Change DID trunk block to rotary or touch-tone signaling:</p> <ul style="list-style-type: none"> ■ LinesTrunks→DID→Signaling <p>Extension Programming for Rotary Dialing</p> <p>Change rotary signaling:</p> <ul style="list-style-type: none"> ■ Options→More→Rotary→Delay/No Delay <p>Enable rotary signaling:</p> <ul style="list-style-type: none"> ■ Extensions→More→More→RotaryEnable→Dial extension numbers→Enter→Exit (Release 7.0 and later systems) <p>To disable rotary signaling, you must delete the extensions you entered.</p>
Factory Settings	
DID	Rotary
Loop-Start/Ground-Start	Touch-tone
Tie	Rotary
Rotary Signaling	Delay

Description

Touch-tone, tip/ring devices, such as single-line telephones or fax machines, are equipped with a dialpad that generates dual-tone multifrequency (DTMF) signals when a dial button is pressed. Analog multiline, MLX, ETR, and MLS telephones

are equipped with dialpads that generate digitally coded signals when a dial button is pressed. The duration of the signal sent is 50 milliseconds (50 ms) and is not adjustable.

Beginning in Release 7.0, you can program tip/ring ports to use rotary signaling. You can program any tip/ring port on an individual basis (including ports on the 412 LS-ID-ETR and 016 ETR modules that are programmed for tip/ring operation). The factory setting is that rotary signaling is disabled.

Whenever the system receives a rotary digit on a port, it determines if the port is programmed as rotary-enabled. If the port is rotary-enabled, the system processes the digit. If the port is not rotary-enabled, the digit is rejected. Touch-tone digits are always accepted by the port, regardless if it is rotary-enabled or not.

A touch-tone receiver (TTR) is required either to make calls from tip/ring equipment or to use the Remote Access feature. TTRs are provided on 400 (LS), 400 GS/LS, 800 DID, 008 OPT, 800 GS/LS-ID, 016 (T/R), 012 (T/R), 412 LS-ID-ETR, and 016 ETR modules. Normally, these TTRs are sufficient to handle the calls originated from these modules. Additional TTRs, however, may be needed to support the following services:

- Tie trunks and T1-emulated tie trunks set for DTMF signaling
- Tandem tie trunks and T1-emulated tandem tie trunks used in a private network (Release 6.0 and later systems)
- Remote Access
- Account Code Entry
- Authorization Codes
- IS II/III AUDIX Voice Power
- IS II/III Integrated Voice Power Automated Attendant
- IS III Fax Attendant
- MERLIN Mail
- MERLIN LEGEND Mail
- Messaging 2000
- Enhanced Service Center (ESC)
- Lucent Technologies Attendant
- Intuity CONVERSANT
- Intuity AUDIX

- Message-Waiting light updating for Centralized Voice Messaging when the updating codes are sent over tandem tie or T1-emulated tandem tie trunks (Release 6.1 or later systems, Hybrid/PBX mode only)



NOTE:

When Messaging-Waiting light updates are sent over PRI tandem trunks, no TTRs are needed.

- Group Calling: Prompt-Based Overflow setting (Release 6.0 and later systems)

If more TTRs are needed to support the services listed above, 400 GS/LS modules can be added. Each 400 GS/LS module provides four TTRs. [Table 43](#) shows the estimated number of TTRs needed for the operation of the communications system, depending on the system's call volume and the use of account codes. Additional TTRs may be required to support voice messaging systems and delay announcement devices used by calling groups (see [Table 44](#), [Table 45](#), and [Table 46](#) below).



NOTE:

You must consider the call traffic across a private network when estimating the number of required TTRs. This includes calls on analog tandem tie trunks and T1-emulated tandem tie trunks. In addition, if your private network includes Centralized Voice Messaging, you must consider the call traffic coming across the private network for the voice messaging system and the TTRs required for the updating of Message Waiting lights (Release 6.1 or later systems). For this updating, a TTR is required at the sending end and the receiving end. If the systems in the private network are connected by PRI trunks, no additional TTRs are needed.

[Table 43](#) is based on the assumption that the system already has basic telephones, remote access, and tie trunks.

Table 43. System Requirements for TTRs

Calls per Hour	TTRs Required	
	No Account Codes Used	Account Codes Used
110	2	4
180	4	6
350	4	8
420	6	8
610	6	10
710	8	10

If one or more voice messaging systems are used, additional TTRs are needed (see [Table 44](#)).

Table 44. TTRs Required by Voice Messaging Systems/Auto Attendants

No. of VMS Ports	No. of TTRs Required
1	1
2	1
3	2
4	2
6	3
8	4
12 ¹	6*
16	8
18	8

¹ If a 12-port MERLIN LEGEND Enhanced Service Center is used, 8 TTRs are required.

In Release 6.0 and later systems, when you program a calling group for Prompt-Based Overflow, additional TTRs are required for primary and secondary delay announcement devices (see [Table 45](#) and [Table 46](#)).



NOTE:

If no announcement is used on a primary or secondary delay announcement device, no TTRs are needed.

Table 45. TTRs Required for Primary Delay Announcement Devices When Using Prompt-Based Overflow

No. of Devices	No. of TTRs Required
1	1
2	2
3	3
4	4
5	4
6	5
7	5
8 or more	6

Table 46. TTRs Required for Secondary Delay Announcement Devices When Using Prompt-Based Overflow

No. of Devices	No. of TTRs Required
1	1
2	1
3	1
4	2
5	2
6	2
7	3
8	3
9	3
10 or more	4

Follow these steps to calculate the number of TTRs required by the system:

1. Total the TTRs needed for the volume of calls per hour (see [Table 43](#)).



NOTE:

You must consider the call traffic across a private network when estimating the number of required TTRs. This includes calls on analog tandem tie trunks and T1-emulated tandem tie trunks. In addition, if your private network includes Centralized Voice Messaging, you must consider the call traffic coming across the private network for the voice messaging system and the TTRs required for the updating of Message Waiting lights (Release 6.1 or later systems). For this updating, a TTR is required at the sending

end and the receiving end. If the systems in the private network are connected by PRI trunks, no additional TTRs are needed.

2. Calculate the number of TTRs required by the voice messaging system(s) (see [Table 44](#)).
3. Calculate the number of TTRs needed for delay announcement devices, both primary and secondary (see [Table 45](#) and [Table 46](#)). If no announcement is used on a primary or secondary delay announcement device, no TTRs are needed.
4. Calculate the total TTRs available on the system by adding the TTRs on the modules that supply them (see [Table 47](#).)
5. Compare the total number of TTRs required by the system to the total number of TTRs provided by the modules in the system. If the number required is greater than the number provided, one or more modules must be added to the system.

Table 47. Modules with TTRs

Module	No. of TTRs
008 OPT	2
012 (T/R)	2
016 (T/R)	4
016 ETR	4
400 GS/LS	4
400 (LS)	4
412 LS-ID-ETR	2
800 DID	2
800 GS/LS-ID	2
MERLIN LEGEND Mail module	2

TTR Settings

A TTR is allocated for 24 seconds at the beginning of the call and is reset to 24 seconds each time another digit is entered. If a digit is not dialed within the time frame, the TTR is removed from the call and the following occurs, depending on whether the call is an inside or outside call:

- An inside call is disconnected after 24 seconds.
- For an outside call, the user hears a recording or a fast busy tone; then the call is disconnected.

The system is factory-set to generate touch-tone signals for all lines/trunks, except tie trunks, when users dial outside calls. The factory setting can be

Features

Touch-Tone or Rotary Signaling

722

changed for individual rotary trunks so that touch-tone signals are converted to rotary pulses for transmission to the central office.

Rotary signaling can be set for Delay or No Delay. Delay is the factory setting; it makes the rotary pulse inaudible to the telephone user and delays sending the dialed number from the control unit to the line/trunk until the user is finished dialing.

Considerations and Constraints

Tie trunks are set up either to send signals to or receive signals from another PBX, or they are set up to be bidirectional, that is, to send and receive signals. If the system has bidirectional tie trunks, the signaling can be set for both directions independently. For example, outgoing (outmode) signaling can be rotary and incoming (inmode) can be touch-tone. Consult the local telephone company for more information.

The audible feedback for touch tones generated when a user presses a dialpad button can be heard by any user who shares a personal line or a Shared SA button with the telephone that is used to make a call. Therefore, when dialing confidential numbers such as passwords or account information, the user should take precautions, such as activating Privacy, to prevent others from hearing the touch tones.

Touch-tone dial mode cannot be programmed for DID trunks that are immediate start.

Touch-tone dial mode cannot be programmed for incoming, immediate tie trunks.

Touch-tone, single-line telephone users cannot make calls using individual lines/trunks programmed for rotary operation. The touch-tone signals generated from the telephone while dialing are transmitted to the central office at the same time the rotary signals are sent by the system. The central office receives both signals and cannot process the call.

Mode Differences

In Behind Switch mode, the factory setting for rotary signaling should be changed to No Delay.

Transfer

At a Glance

Users Affected	Telephone users, operators
Reports Affected	Operator Information, SMDR, System Information (SysSet-up)
Modes	All
Telephones	All
Programming Code	*774 (Behind Switch mode only)
MLX Display Label	Transfer [Trans]
System Programming	<p>To program the Transfer button in Behind Switch mode:</p> <ul style="list-style-type: none"> ■ Options→Behind Switch→Transfer <p>To specify how long a transferred call goes unanswered before returning:</p> <ul style="list-style-type: none"> ■ Options→Transfer→Return Time <p>To assign one-touch Transfer (with either automatic or manual completion) or one-touch Hold:</p> <ul style="list-style-type: none"> ■ Options→Transfer→One Touch→Transfer (Manual/Automatic/Hold) <p>To select button type (Ring or Voice) to use for transfers:</p> <ul style="list-style-type: none"> ■ Options→Transfer→Type <p>To specify either Music-On-Hold or ringback for the Transfer Audible:</p> <ul style="list-style-type: none"> ■ Options→Transfer→Audible <p>To enable trunk-to-trunk transfers for an extension (Release 3.1 and later systems only):</p> <ul style="list-style-type: none"> ■ Extensions→More→TrkTransfer→Dial ext. no.→Enter <p>To disable trunk-to-trunk transfers for an extension (Release 3.1 and later systems only):</p> <ul style="list-style-type: none"> ■ Extensions→More→TrkTransfer→Dial ext. no.→Delete

Factory Settings

Transfer Return Time	4 rings (range 1–9 rings, 0 = disabled)
One-Touch Hold or Transfer	Key and Hybrid/PBX: One-Touch Transfer with Automatic Completion; Behind Switch: One-Touch Hold
One-Touch Transfer	Automatic Completion
Type of Transfer	Ring
Transfer Audible	
Outside callers	Music-On-Hold (if available)
Inside callers	Ringback (cannot be changed)
Trunk-to-Trunk Transfer	Disabled (Release 3.1 and later systems only)

Description

Users can transfer inside or outside calls either to inside extensions or to outside numbers. Transferring an outside call to an outside number is called *trunk-to-trunk transfer*.

In Release 6.0 and later systems (Hybrid/PBX mode only), transfers to non-local dial plan extensions are actually trunk-to-trunk transfers, although users initiate them as they do inside transfers. Most extensions, including those equipped with single-line telephones, can make these calls, regardless of system programming to allow or disallow trunk-to-trunk transfers. Refer to [“Trunk-to-Trunk Transfer” on page 728](#).

Calls can be transferred with or without consultation:

- **With Consultation.** A transfer with consultation can be made only to an inside extension or, in Release 6.0 and later systems, to a non-local dial plan extension from a telephone (not from a CTI-linked PassageWay Telephony services client). The user initiating the transfer calls the destination extension and speaks to the person at that extension before completing the transfer.

If the transfer is initiated on an SA Voice or ICOM Voice button, the transfer is called a *voice-announced transfer* (see [“Type of Transfer” on page 727](#)). In a voice-announced transfer, the user initiating the transfer can speak to the person at the inside destination extension on that person’s speakerphone before completing the transfer. When the transfer is completed, it arrives at the destination extension as a ringing call. In Release 6.0 and later systems (Hybrid/PBX mode only), voice-announced transfers cannot be made to non-local dial plan extensions.

- **Without Consultation.** A transfer without consultation can be made either to an inside extension or to an outside number. The user initiating the transfer completes the transfer before the person at the destination extension or number answers.



NOTE:

QCC system operators ordinarily use the Start and Release buttons to transfer calls rather than the transfer process described in this section. For more information, see [“Queued Call Console \(QCC\)” on page 565](#).

Transfer Options

The sections below describe system-programmed options that determine how to transfer calls.

Transfer Return Time

If a transferred call is unanswered within a programmed number of rings, it rings back at the transfer originator's telephone. This transfer return time can be set to a value of 1 to 9 rings, or 0 (the factory setting is 4 rings). If the transfer return time is set to 0, a transferred call continues to ring until either it is answered or the caller hangs up.

In Release 6.0 and later systems (Hybrid/PBX mode only), transfers across networked systems over tandem tie trunks do not return to the transferring extension. If such a call is transferred to a busy or invalid non-local dial plan extension or one with Do Not Disturb turned on, the transferred party hears busy or fast busy tone and must hang up and call back in order to speak with someone. If a transfer is made across a network over tandem PRI trunks only, it returns to the transfer originator in the event that the intended destination is busy, invalid, or has turned on Do Not Disturb.

A returning transferred call continues to ring on the telephone it to which it was transferred and on the extension that originated the transfer until either user answers or the caller hangs up.

Timing begins when the transfer is completed. If the transfer fails for any reason (such as an invalid destination), the transfer return time is automatically set to 2 rings to allow a faster return unless the programmed value is 0 (no transfer return).

Except on a QCC, returning transferred calls ring at the originating extension with a distinctive ring (a 3-ring pattern). Display telephone users also see the call type Return on the display.



NOTES:

- A call transferred to an extension programmed as a fax extension does not return to the originator, but continues to ring at the fax extension. This eliminates the possibility of a high-pitched fax tone being heard by the person who answers the returning call.
- A call transferred to a calling group does not return, and the ringing and flashing LED is cleared from the SA or ICOM button on the originator's telephone as soon as the transfer is completed. The call does not stay on hold.

One-Touch Transfer

The system is programmed either for one-touch Transfer (the factory setting in Hybrid/PBX and Key modes) or for one-touch Hold (described below). With one-touch Transfer, a telephone user or operator can transfer a call to another extension by pressing a programmed Auto Dial or DSS) button for the extension. With this single press of a button, the active call is put on hold and the system automatically selects an SA or ICOM button and dials the transfer destination.

With one-touch Transfer, the system is also programmed to complete transfers in one of the following ways:

- **Automatic Completion** (factory setting). A transfer is completed automatically as soon as the Auto Dial or DSS button is pressed. The call is removed from the telephone that initiated the transfer and begins ringing at the destination extension.

One-touch Transfer with automatic completion does not allow a transfer with consultation. This type of transfer is always a ringing call, and voice announcements cannot be made. However, telephone users and operators can still initiate a transfer with consultation by pressing the Transfer button, then either dialing the destination extension or pressing an Auto Dial or DSS button.

When one-touch Transfer with automatic completion is programmed, the transfer of a call either to a busy extension or to an extension with Do Not Disturb active is completed automatically, although the call cannot be connected. The call does not return to the transfer originator until the transfer return time expires.

In Release 6.0 and later systems (Hybrid/PBX mode only), if a DLC operator selects the DSS button for the ARS access code while on another call, any transfer over the private network requires manual completion.

- **Manual Completion.** One-touch Transfer with manual completion allows a transfer with consultation; the user can delay completing the transfer until the destination extension is answered. The originator completes the transfer by pressing the Transfer button or another line button, or by hanging up.

One-Touch Hold

If the system is not programmed for one-touch Transfer, it is programmed for one-touch Hold (the factory setting in Behind Switch mode). This Transfer option applies to outside calls only. With one-touch Hold, a telephone user or operator can transfer a call on an outside line button to another extension with a shared button for the same outside line. The user or operator presses an Auto Dial or DSS button for the extension to initiate the transfer. The outside call is put on hold, and the system automatically selects an SA or ICOM button and dials the transfer destination. The originator announces the call to the person at the destination extension, who completes the transfer by pressing the line button with the call.

There is no transfer return function with one-touch Hold. If the transfer destination does not answer or is busy, either the person who initiated the transfer must notify the outside caller or the call remains on hold.

Type of Transfer

The system can be programmed for automatic selection of either a ringing button—SA Ring or ICOM Ring (the factory setting)—or a voice-announce button—SA Voice or ICOM Voice—when a transfer is initiated. Type of transfer does not apply to calls transferred outside the system.



NOTE:

In Release 6.0 and later systems (Hybrid/PBX mode only), voice-announced transfer should not be programmed, because calls to non-local dial plan extensions cannot be voice-announced.

If the system is programmed to select a ring button and one is available, the call rings at the destination extension. If the system is programmed to select a voice-announce button and one is available, the person at the destination extension hears a voice announcement. If that person does not have a speakerphone, has turned off Voice Announce, or is already using the speakerphone, the call is converted to a ringing call. A transfer to an outside number is always a ringing call.

If the specified type of button is not available, the system automatically selects the next available SA or ICOM button. If no SA or ICOM button is available, the caller is put on hold for transfer and no line is selected. The user can then select a Shared SA button, or an SA Originate Only or ICOM Originate Only button, wait

for a free SA or ICOM button, or select an outside line button to transfer a call to an outside number.

The following types of calls ring at the destination to which they are transferred, regardless of the programmed type of Transfer:

- Calls that arrive after waiting in a callback or call-waiting queue
- Calls to busy extensions that do not have the ability to receive Voice Announce calls when they are busy
- Calls to a telephone with Voice Announce turned off
- Calls to MLX extensions that have Voice Announce on Idle Only turned on and the user is off-hook (Release 7.0 and later systems).
- Calls to a telephone whose speakerphone is in use
- Calls to single-line telephones
- Calls to a calling group
- Calls to a QCC operator

Transfer to Busy Extension

If a call is transferred to an extension with no SA or ICOM buttons available, the call is queued for the destination extension. If the destination extension is an MLX display telephone, it receives a *Call Waiting* message. On any type of telephone with Call Waiting programmed, the destination extension receives a call-waiting tone. If an SA or ICOM button does not become available within the transfer return interval, the call is returned to the extension that initiated the transfer.

In Release 6.0 and later systems (Hybrid/PBX mode only), if a call is transferred over tandem tie trunks to a non-local dial plan extension that is unavailable, it is not returned. The caller hears a busy tone. If the call is transferred over tandem PRI facilities only, it returns when the intended destination is busy or unavailable.

Trunk-to-Trunk Transfer

Trunk-to-trunk transfer (a call transferred to an outside number) is not allowed when the line/trunk with the incoming call is a loop-start line that is not programmed for reliable disconnect. (The Reliable Disconnect setting indicates that a disconnect signal is sent by the local telephone company to the system shortly after a caller hangs up.)

In Release 3.1 and later systems, trunk-to-trunk transfers can be blocked for an extension, whether or not the lines/trunks involved are programmed for reliable disconnect. The factory setting restricts all extensions from making trunk-to-trunk

transfers. Extensions that should not be restricted must be individually programmed to allow trunk-to-trunk transfer.

Users can transfer inside or outside calls either to inside extensions or to outside numbers. Transferring an outside call to an outside number is called *trunk-to-trunk transfer*.

In Release 6.0 and later systems (Hybrid/PBX mode only), transfers to non-local dial plan extensions are actually trunk-to-trunk transfers, although users initiate them as they do inside transfers. Most extensions, including those equipped with single-line telephones, can make these calls, regardless of system programming to allow or disallow trunk-to-trunk transfers.

In Release 6.1 and later systems, when an Automated Attendant transfers a call to a non-local extension, the transferring MERLIN LEGEND System monitors the call to ensure that it is answered. If the non-local extension is not available or the call is not answered within the transfer redirect timeout period (fixed at 32 seconds), the call stops ringing at the non-local destination and is redirected to the extension on the same system as the Automated Attendant that is programmed to receive redirected calls. This redirect extension can be a QCC queue, a calling group, or an individual extension.

Calls can be transferred with or without consultation:

- **With Consultation.** A transfer with consultation can be made only to an inside extension or, in Release 6.0 and later systems, to a non-local dial plan extension from a telephone (not from a CTI-linked PassageWay Telephony services client). The user initiating the transfer calls the destination extension and speaks to the person at that extension before completing the transfer.

If the transfer is initiated on an SA Voice or ICOM Voice button, the transfer is called a *voice-announced transfer* (see [“Type of Transfer” on page 727](#)). In a voice-announced transfer, the user initiating the transfer can speak to the person at the inside destination extension on that person’s speakerphone before completing the transfer. When the transfer is completed, it arrives at the destination extension as a ringing call. In Release 6.0 and later systems (Hybrid/PBX mode only), voice-announced transfers cannot be made to non-local dial plan extensions.

**NOTE:**

ETR and MLS telephones that are busy cannot receive a voice-announced transfer. Instead, the call rings.

- **Without Consultation.** A transfer without consultation can be made either to an inside extension or to an outside number. The user initiating the transfer completes the transfer before the person at the destination extension or number answers.



NOTE:

QCC system operators ordinarily use the Start and Release buttons to transfer calls rather than the transfer process described in this section. For more information, see [“Queued Call Console \(QCC\)” on page 565](#).

Disable Transfer on Single-Line Telephones

The system manager can disable the ability to transfer calls on single-line telephones in Release 4.0 and later releases. This is done in centralized telephone programming by removing all but one SA or ICOM buttons from the telephones. Any feature that relies on the use of a second dial tone also does not work on any single-line telephone with transfer disabled. This includes the Account Code Entry, Pickup, Call Waiting, Conference, Privacy, and Transfer features.

Considerations and Constraints

Calls transferred to outside numbers may vary in transmission quality.

The ability to transfer inside calls to outside numbers cannot be specifically blocked for an individual extension. Calling restrictions or Disallowed Lists, however, can be assigned to individual extensions to prevent outward or toll calls.

When an outside call is transferred to an outside number (trunk-to-trunk transfer), two outside lines are used for as long as the call is in progress.

When a call is transferred to an outside number, the system does not recognize the transfer until a dialing time-out occurs. Avoid a delay by dialing # after dialing the telephone number.

When you try to complete a transfer to an outside number under the following conditions, the call to the outside destination is disconnected:

- The outside line that the incoming call is using is a loop-start line programmed for unreliable disconnect.
- Another inside user has joined the call and the call is now a conference call, which cannot be transferred.

The transfer originator does not receive an error tone to indicate that the transfer has been denied. When a call is received on a T1 channel that is programmed to emulate a loop-start line and then is transferred to an outside telephone number and the caller hangs up before the call is answered, the call is not disconnected and remains on hold.

Except when one-touch Hold is used, a transferred call always arrives on an SA or ICOM button or, when transferred to a QCC operator, on a Call button.

Calls cannot be transferred *from* an extension programmed for a fax machine, but inside and outside calls can be transferred *to* a fax machine. A call transferred to a fax extension does not return to the originator, but continues to ring at the fax extension. This eliminates the possibility of a high-pitched fax tone being heard by the person who answers the returning call.

If a multiline telephone user presses the Feature button after initiating a transfer, the dialed digits activate a feature (for example, Privacy). After the feature is activated, the user should redial the extension or telephone number to transfer the call.

Busy ETR and MLS telephones cannot receive voice-announced transfers. The calls ring instead.

In Release 2.1 and later systems, an 012 (T/R) port that is programmed as a generic VMI port can transfer an outside call to an outside number (trunk-to-trunk transfer). Release 2.0 and earlier systems can perform a trunk-to-trunk transfer only on ports programmed as integrated VMI.



SECURITY ALERT:

Calling restrictions (for example, Disallowed Lists, Toll Restriction, FRLs) should be programmed, as appropriate, to minimize toll fraud, especially if a single-line telephone is connected to an integrated VMI port. See [“Calling Restrictions” on page 132](#) for additional information about programming calling restrictions.

In Release 4.0 and later releases, when a single-line telephone user hangs up on a call that is on hold pending transfer, the call is dropped.

Mode Differences

Behind Switch Mode

In Behind Switch mode, when the fixed Transfer button is pressed, the Transfer feature of the host switch is used instead of the system's Transfer feature. To activate Transfer, however, the fixed Transfer button on an MLX or analog multiline telephone must be programmed through system programming to send a timed flash plus the code expected by the host. The fixed button has no effect when pressed during an intercom call within the communications system; inside transfers are made using trunk-to-trunk transfer on prime lines. If use of the communications system's Transfer feature is also desired (to lower traffic on prime lines, for example), it must be programmed on an available line button on

each multiline telephone through either extension programming or centralized telephone programming, and then can be used only when transferring within the local system (this option is not available in Hybrid/PBX or Key mode). One-touch Hold is the factory setting in Behind Switch mode. The selection of one-touch Transfer is not blocked in system programming, but the setting is always one-touch Hold regardless of the option chosen.

In Behind Switch Mode, the Transfer Return Time and Type of Transfer options apply only to inside transfers (ICOM/SA calls made within the communications system) in which the caller, the transfer originator, and the transfer destination are all system extensions.

Telephone Differences

Queued Call Consoles

A QCC operator uses the Start and Release buttons or a DSS button to transfer calls. Pressing the Transfer button on a QCC, however, is the same as pressing the Start button.

A QCC operator cannot make or receive voice-announced transfers.

When a QCC operator uses the Start and Release buttons to transfer a call, the QCC return ring interval applies for transfer return timing instead of the transfer return time. The QCC return ring interval is the number of rings (1–15) before an unanswered extended call returns to the QCC queue. See [“Queued Call Console \(QCC\)” on page 565](#) for additional details.

Single-Line Telephones

The One-Touch Transfer option does not apply to single-line telephones.

Single-line telephone users cannot make voice-announced transfers. In releases prior to 6.0, a single-line telephone user cannot transfer an outside call to an outside number. If the user tries to complete a trunk-to-trunk transfer, the caller remains on hold for transfer and the transfer destination is disconnected. In Release 3.1 and later systems prior to Release 6.0, a single-line telephone is blocked from making trunk-to-trunk transfers even if it is programmed as allowed.

To make a transfer with consultation, a single-line telephone user presses and releases either the Recall or Flash button or the switchhook. The call is put on hold. The user then dials the destination extension. After consultation, the user hangs up and the call is transferred. If the transfer cannot be made, the user presses and releases either the Recall or Flash button or the switchhook to return to the caller. To make a transfer without consultation, the single-line telephone

user presses and releases either the Recall or Flash button or the switchhook, dials the extension or outside number, and hangs up. The call is transferred.

If a single-line telephone with positive or timed disconnect is used—for example, Lucent Technologies models 2500YMGL and 2500MMGK—pressing the switchhook disconnects the call. With this type of telephone, the Recall button must be used instead of the switchhook to transfer a call.

Feature Interactions

- Account Code Entry** When a call is transferred, the destination extension cannot change an account code entered at the originating extension.
- Authorization Code** The Authorization Code feature does not affect the ability to make a trunk-to-trunk transfer. If the telephone is restricted from making a trunk-to-trunk transfer, entering an Authorization Code does not remove this restriction.
- Auto Dial** Users can press inside Auto Dial buttons instead of dialing extension numbers to transfer calls. To use one-touch Transfer, users must program an Auto Dial button for every extension to which they transfer calls. When a system operator transfers a call and it returns unanswered, the green LED next to the Auto Dial button flashes to indicate the extension from which the call is returning. Only system operators receive this indication.
- Automatic Line Selection** The ALS sequence does not apply when the Transfer button is pressed.
- Basic Rate Interface** Calls on BRI lines are available for the MERLIN LEGEND Communications System Transfer feature. The central office-based Transfer feature is not supported by the MERLIN LEGEND Communications System.
- Callback** A queued callback call cannot be transferred, but calls transferred to busy extensions are eligible for Callback. When a user reaches a busy extension while transferring a call, Automatic Callback or Selective Callback can be used to queue the call before completing the transfer. The caller hears ringback or Music-On-Hold.
- When the extension is available, the call is transferred to the extension automatically. If the extension is not available before the transfer return time expires, the call is removed from the callback queue and returned to the originator.
- Caller ID** If a call comes in over a line connected to an 800 GS/LS-ID, 408 GS/LS-MLX-ID, or 412 LS-ID-ETR module and the customer subscribes to Caller ID service (loop-start lines only), when the call is transferred, the caller's telephone number or name (Release 7.0 and later systems) is shown on Line 1 of the first screen. The extension that initiated the transfer is shown

- Caller ID**
(continued) on Line 1 of the second screen. (The call must be from an area where call identification is supported.)
- Caller ID information is displayed when a call returns from transfer because the extension to which the call was transferred is either busy or not answering.
- Call Waiting** If a transfer is completed to a busy extension, the destination hears the call-waiting tone, if programmed, and the caller hears call-waiting ringback. The call waits in queue until the transfer return time expires. Calls answered by picking up a call-waiting call cannot be transferred.
- Camp-On** A transfer can be completed by using the Camp-On feature, whether or not the destination extension is busy. When the feature is used, the Camp-On return interval is used instead of the transfer return time. The Camp-On return interval is normally longer.
- A transfer can be camped on to an inside extension only. If a user presses the programmed Camp-On button or dials the Camp-On feature code while transferring a call to an outside number, the call to the outside number is disconnected. The original call remains on hold.
- Conference** A conference call cannot be transferred. A user who starts a conference sequence, however, can complete it by pressing the Transfer button and transferring the original call instead of completing the conference. Similarly, if a transfer originator has one person on hold for transfer and, after dialing the destination extension or telephone number, decides to establish a conference call, he or she can press the Conf button to establish the conference instead of completing the transfer.
- Coverage** Calls transferred to a sender are eligible for Individual and/or Group Coverage. If the sender is using Coverage On/Off to prevent calls from going to coverage and does not have an available SA or ICOM button to receive a transferred call, however, the sender hears a call-waiting tone, even if an Individual or Group Coverage receiver is available.
- Calls answered on a Primary Cover, Secondary Cover, or Group Cover button can be transferred using one-touch Transfer or the Transfer button.
- Transfer returns are not eligible for Individual or Group Coverage.
- CTI Link** CTI link applications can control inside transfers, not transfers to outside numbers. When a CTI application is used to initiate a transfer, caller information is passed to a destination that supports screen pop.
- When a transfer is initiated manually, using the telephone at an extension where a CTI application is installed, screen pop is not initiated at a destination that supports screen pop, even if the CTI application is used to complete the transfer.
- When performed by a QCC operator or unmonitored DLC operator, a transfer generates screen pop of inside or outside caller information at destinations that support screen pop.

Digital Data Calls

Data calls cannot be transferred.

2B data video calls require both B-channels at a video workstation.

Direct Station Selector

DSS buttons can be used to transfer outside calls using one-touch Hold only by a DLC operator; a QCC operator cannot use this feature. When one-touch Hold is programmed, if a DLC operator presses a DSS button with an inside caller on the line or, in Hybrid/PBX mode, with an outside caller on an SA button, the call is not put on hold. A beep is sent to the extension instead.

When one-touch Transfer (with either automatic or manual completion) is programmed, and a system operator presses a DSS button while a caller is on the line and no SA or ICOM button is available to transfer the call, the call does not go on hold. If the operator hangs up, the caller is disconnected.

Direct Voice Mail

A user with a Direct Voice Mail button can activate Direct Voice Mail after starting to transfer a call. While a transfer is being made, press the Direct Voice Mail button to transfer the call to the extension's voice mail. Complete the transfer as usual by pressing the Transfer button or hanging up.

Display

When an MLX display telephone user presses the Transfer button, the display prompts the user to dial the extension number and shows the digits as they are dialed. When dialing is completed, the display shows the name of the person at the destination extension, if labels are programmed.

Transfer return calls are identified by call type and by the name and extension number to which the call was transferred. The second page of the display also shows the caller information. When an MLX or ETR display telephone user receives a transferred call, the display shows the type of call and the caller information on Page 1. MLS telephone users can view caller information by pre- or post-selecting the line button for that call. When an inside call is being transferred, the display shows the extension number or line/trunk number. When an outside call is being transferred, the display shows either the line on which the call came in or the caller's telephone number—if PRI-based number identification or Caller ID is available. The transfer originator is shown on Page 2 of MLX and ETR phone displays.

When an MLX display telephone user makes a voice-announced transfer, the display on his or her telephone shows *Announce to*. After the transfer is completed, the user's display shows *Call Transferred*.

When an MLX or ETR display telephone user does not complete a transfer (for example because Do Not Disturb is on at the destination extension), the call returns to the originator's telephone and call information is displayed. The reason for the incomplete transfer is not indicated.

- Do Not Disturb** If a call is transferred to an extension that has Do Not Disturb on and that has neither forwarding on nor coverage receivers, the call immediately returns to the transfer originator. If there are coverage receivers, the transfer returns to the originator after the transfer return time expires.
- Fax Extension** If an extension is programmed as a fax extension, the telephone at that extension is unable to use the Transfer button.
- Forward and Follow Me** Transferred inside and outside calls are forwarded. If a user transfers a call to an extension with forwarding activated, the person receiving the forwarded calls hears one ring, indicating an inside call. In addition, if the person has a display telephone, he or she sees the call information for an inside call.
- In Release 6.0 and later systems, all transfers to an extension with Centrex Transfer via Remote Call Forwarding active behave like transfers with automatic completion. Consultation is not permitted. The transfer originator is disconnected and the call is sent to the outside telephone number.
- Group Calling** A call transferred to a calling group does not return to the originator; the call is handled just as any other call received in the calling group queue. For example, the system follows the programmed hunt sequence to locate an available calling group member, and the call is eligible for a delay announcement if one is programmed.
- A calling group member is considered available for a call while in the process of transferring a call. He or she is moved to the end of the most-idle queue (Release 5.0 and later systems).
- Voice-announced transfers cannot be made to a calling group. There is no limit to the number of calls that can be transferred to a calling group.
- When an inside caller is transferred to a calling group and no members are available, the caller hears regular ringback. When an outside caller is transferred to a calling group and no members are available, the caller hears a regular ringback or Music-On-Hold, if programmed.
- If a call being transferred to a calling group is on an SA or ICOM button, the button is cleared.
- Headset Options** When an MLX telephone user (except for a QCC operator) transfers a call, Headset Auto Answer is turned off and must be turned on manually to resume using the feature.
- Hold** Calls on hold for transfer are timed so that the user or system operator hears a reminder after the timer expires.

- Hold**
(continued)
- In Release 2.1 and later systems, a call that has been put on hold at a Cover, SA, Shared SA, or Pool button can be accessed by a user who has a personal line button for the call. When the call is accessed, the green LED next to the personal line lights steadily; however, the call remains on hold at the Cover, SA, SSA, or Pool button. The user who accesses the personal line cannot transfer the call. To transfer a call on hold at a Cover, SA, SSA or Pool button, use Pickup instead of answering on a personal line button.
- HotLine**
- Transfer is not available at HotLine extensions (Release 5.0 and later systems).
- Inspect**
- If an MLX telephone user presses the Transfer button while in Inspect mode, Inspect is canceled, the user is returned to the Home screen, and transfer is initiated.
- Last Number Dial**
- The Last Number Dial feature can be used to originate a transfer to an outside telephone number.
- Line Request**
- Returning transferred calls cancel Line Request.
- Messaging**
- A nondisplay telephone user who uses Leave Message to send a message while a transfer is in progress cannot determine who received the message.
- For example, suppose that Extension A calls Extension B, and Extension B transfers the call to Extension C. If Extension A sends a message before the transfer is completed, Extension B receives the message. If Extension A sends a message after Extension B completes the transfer, Extension C receives the message, even if Extension C does not answer and the call is ringing at Extension B as a transfer return.
- If an inside call is transferred to a telephone with a posted message, only the display telephone user who transfers the call sees the message. The original caller does not see the posted message even after the transfer is completed.
- If a call is transferred to an extension programmed for a fax machine, the message indication is not sent to the fax message-waiting receiver, regardless of the amount of time programmed for the fax message-waiting threshold.
- Microphone Disable**
- A call to a user whose microphone is disabled can be transferred with a voice announcement, but the user must lift the handset to talk.
- Multi-Function Module**
- Calls cannot be transferred from an MFM because the MFM cannot send a switchhook flash.
- Music-On-Hold**
- An outside caller hears Music-On-Hold if it is programmed as the transfer audible. Music is played only before the transfer is completed by the originating extension. The caller hears music when the Transfer button is pressed and while the destination extension is being dialed. When the transfer originator presses the Transfer button a second time or hangs up, the caller hears ringback.

Paging	<p>Calls cannot be transferred either to paging groups or the loudspeaker paging extension.</p>
Park	<p>A user can park calls by pressing the Transfer button and dialing his or her own extension. A DLC operator also can press the Transfer button and dial a system operator park zone extension. When either of these methods is used, the transfer must be completed by pressing the Transfer button or hanging up. This method cannot be used by QCC operators.</p>
Personal Lines	<p>If a call is received on a personal line and is transferred to another user who receives the call on an SA or ICOM button and then puts the call on hold, another user who shares the personal line cannot select the shared personal line button and pick up the call. If for some reason the person who received the transfer and put the call on hold cannot return to the call, another user must use Pickup to pick up the call. (For example, an operator can take a message and then disconnect the caller.)</p> <p>The hold timer or operator hold timer applies to a call on hold for transfer. The user or operator hears a reminder (a beep or abbreviated ring) after the timer expires.</p>
Pickup	<p>A transferred call can be answered by using Pickup.</p>
Primary Rate Interface (PRI) and T1	<p>If a call comes in over a PRI facility where number identification is available, the caller's telephone number is shown on Line 1 of the first screen when the call is transferred. The extension that initiated the transfer is shown on Line 1 of the second screen.</p> <p>For trunk-to-trunk transfer with no extension number involved, the Calling Party Number for the outbound call is the programmed base number.</p> <p>Data calls cannot be transferred.</p>
Recall/Timed Flash	<p>A single-line telephone user with a Recall or Flash button can use it to transfer a call.</p>
Ringing Options	<p>Transfer returns ring until answered and do not receive abbreviated ringing. Ring Timing options are ignored on a transfer return call; the button rings immediately, even if it is programmed for No Ring.</p>
Saved Number Dial	<p>The Saved Number Dial feature can be used to originate a transfer to an outside telephone number.</p>
Service Observing	<p>In Release 6.1 and later systems, a Service Observer cannot transfer observed calls.</p> <p>If an observed extension transfers a call, the Service Observer is dropped from the call when the transfer is initiated and when it is completed, but the Service Observing session remains active. If the observed extension consults the destination station before the transfer is completed, the Service Observer hears the consultation. Either extension involved in a consultation can be observed.</p>

Service Observing (continued)

If the Service Observer is observing the extension that originally made the call, the Service Observer remains on the call when the transfer is completed.

If the Service Observer is observing the extension that is the destination of the transferred call, the Service Observer hears the call when the transfer is completed.



NOTE:

The most important thing to remember is that a Service Observer observes an extension, not a call. Whenever that extension is active on a call (whether the extension is the originator, the transferer, or the recipient of the call), the Service Observer can observe the call.

Transfer return and transfer redirect calls can be observed.

Trunk-to-trunk transfer calls drop the observer at the completion of the transfer.

Signal/Notify

A Signaling button can be used to dial the destination extension after the Transfer button is pressed but cannot be used to initiate one-touch Transfer.

Speed Dial

Both Personal and System Speed Dial can be used to dial a transfer destination.

SMDR

The number of the extension that hangs up on an incoming outside call is shown in the STN field of the Station Message Detail Recording report, regardless of the number of times the call is transferred within the same system. For a call to an outside number, the extension that dialed the call is shown on the SMDR report, even if the call is then transferred to another extension.

System Access/ Intercom Buttons

Transferred calls always arrive on SA or ICOM buttons. The only exception is that when one-touch Hold is used, the transferred outside call stays on hold on an outside line button until it is picked up. When a transfer is initiated, the system automatically selects an SA or ICOM button (a Shared SA button is not automatically selected). If no button is available, the caller is put on hold for transfer and no line is selected. The user can then select a Shared SA button or an SA Originate Only or ICOM Originate Only button, wait for a free SA or ICOM button, or select an outside line button to transfer a call to an outside number.

A transferred call that returns to the principal extension does not ring on any corresponding Shared SA buttons. If a transfer originator has an SSA button for the person receiving the transfer, the LED next to the SSA button flashes to indicate a ringing call. The call, however, is disconnected if the transfer originator answers.

UDP Features

In Release 6.0 and later systems (Hybrid/PBX mode only), transfers of outside or non-local dial plan calls to non-local dial plan extensions are actually trunk-to-trunk transfers. Most extensions, including those equipped with single-line telephones, can make these calls, regardless of system programming for trunk-to-trunk transfer. The incoming call must be on a trunk with reliable disconnect. If a private network trunk is not available to carry the transferring call, the consultation call can be callback-queued on the first route, but the transfer must still be in progress.

If the system manager has prohibited an extension from making trunk-to-trunk transfers, it is still prevented from transferring inside or outside calls to another local system trunk connected to the PSTN. However, despite prohibitions, the following types of calls are allowed:

- A call on a private network trunk transferred to a non-local dial plan extension.
- A call on an outside central office line/trunk (except on a loop-start line without reliable disconnect) transferred to a non-local dial plan extension.
- A call on a private network trunk transferred to an outside central office line/trunk.

A call transferred over a tandem PRI trunk to a non-local dial plan extension with an MLX or ETR display telephone does not receive the same call information that an inside transfer does. On MLX and ETR telephones only the extension number and label (if programmed) of the transferring extension are shown. Most transfer functions, however, operate normally between local and non-local dial plan extensions, except when transfers are sent by or received by PassageWay Telephony Services clients with a CTI link. Users at these extensions must make manual transfers by using the telephones at their extensions.

Transfers across networked systems over tandem tie trunks do not return to the transferring extension. If such a call is transferred to a busy or invalid non-local dial plan extension or one with Do Not Disturb turned on, the transferred party hears busy or fast busy tone and must hang up and call back in order to speak with someone. If a transfer is made across a network over tandem PRI trunks only, it returns to the transfer originator in the event that the intended destination is busy, invalid, or has Do Not Disturb turned on.

Uniform Dial Plan Features

At a Glance

Users Affected	All
Reports Affected	Non-Local Dial Plan, Extension Information
Modes	Hybrid/PBX
Telephones	All
System Programming	<p>Assign extension number ranges for non-local dial plan extensions:</p> <ul style="list-style-type: none"> ■ SysRenumber→NonLocal UDP→Dial no. of first extension in range→Enter→Dial no. of last extension in range→Enter→Dial no. of dial digits in extension range→EnterDial no. of pattern for extension range→Enter→Exit→Exit→Exit <p>Delete extension number ranges for non-local dial plan extensions:</p> <ul style="list-style-type: none"> ■ SysRenumber→NonLocal UDP→Dial no. of first extension in range→Enter→DelRange→Exit→Exit <p>Specify UDP routes:</p> <ul style="list-style-type: none"> ■ Tables→UDP Routing→Dial pattern no.→Enter→Dial route no.→Enter→Pool→Dial pool dial-out code→Enter→Exit→Exit→Exit→Exit <p>Specify FRLs for UDP routes:</p> <ul style="list-style-type: none"> ■ Tables→UDP Routing→Dial pattern no.→Enter→Dial route no.→Enter→FRL→Dial restriction level→Enter→Exit→Exit→Exit→Exit <p>Specify how many dialed digits should be absorbed (not sent over the trunk) by the system when a UDP call to a non-local extension is made on an identified UDP route:</p> <ul style="list-style-type: none"> ■ Tables→UDP Routing→Dial pattern no.→Enter→Dial route no.→Enter→Absorb→Press Drop→Dial number of absorption digits→Enter→Exit→Exit→Exit→Exit <p>Specify other (extra) digits that must be added by the system to the beginning of the dialed digits when calls are placed on an identified UDP route:</p> <ul style="list-style-type: none"> ■ Tables→UDP Routing→Dial pattern no.→Enter→Dial route no.→Enter→Digits→Press Drop→Dial digits to add→Enter→Exit→Exit→Exit→Exit

Specify voice, data, or both for an identified UDP route (use for routes with pools of PRI or T1 facilities):

- Tables→UDP Routing→Dial pattern no.→Enter→Dial route no.→Enter→Data→Select capability→Enter→Exit→Exit→Exit→Exit

When SMDR is set to record both incoming and outgoing calls, specify how private networked trunk calls should be recorded (for Release 6.1 and later systems):

- LinesTrunks→More→UDP→SMDR→Dial line/trunk no.→Enter→Select logging option

Maximums

UDP Routing Patterns	20 (range 1–20)
UDP Routes	4 (range 1–4)
UDP FRL	6 (range 0–6)
UDP Digit Absorption	11 (range 0–11)
UDP Added Digits	20 (any digits 0–9)
Number of digits in non-local dial plan extension number range	4 (2- and 3-digit numbers also supported)

Factory Settings

Display Preference	Calling number
Switch Identifier	No value; facility not networked
UDP FRL	3
UDP Absorbed Digits	0
UDP Added Digits	0



NOTES:

- This topic only summarizes information about private networks. Detailed information is included in the *Network Reference*.
- DEFINITY ECS and DEFINITY ProLogix Solutions features and operations are beyond the scope of this guide. This book discusses the network from the MERLIN LEGEND Communications Systems' perspective.
- When a network consists of more than two systems, a coordinating system manager should act as a coordinator for all changes to private-network systems' dial plans, non-local dial plans, ARS routing, UDP routing, and remote access. Otherwise, the two system managers should plan together and agree upon any changes that are made subsequently.

Description

In Release 6.0 and later systems (Hybrid/PBX mode only), MERLIN LEGEND Communications Systems can be networked with one another, or with DEFINITY ECS or DEFINITY ProLogix Solutions systems, in private networks. This section describes how the system is set up and used for one aspect of private networks, non-local dial plan extensions, including the following topics:

- Intersystem calling between extensions located at different systems in a private network
- Details of UDP routing for intersystem and other routed calls
- Feature interactions across private networks

[“Tandem Switching” on page 699](#) describes additional features of private networks, including the following topics:

- Switch identifiers
- ARS access to lines/trunks on remote networked systems
- Remote access settings to allow network routing
- Feature interactions with line/trunk features, such as pools and PRI

To take full advantage of UDP functionality, you use system features that also apply to non-networked systems. The descriptions in this topic therefore include references to other sections that provide details. For information about programming networked systems, see *System Programming*. At the end of this topic, “Feature Interactions” provides details about features not mentioned specifically in this section. For further details about network planning and programming, refer to the *Network Reference*.

Intersystem Calling

In a private network, users on one local system can call extensions on other systems in the network. They dial these extensions as inside calls. This topic describes how to set your system up so that local users can reach these non-local dial plan extensions. It also describes how users dial non-local extensions.

Extension Ranges

When local users call other users on a remote private-networked system, the local system manager programs the ranges of extensions of the remote system into a non-local dial plan.

Each switch in the private network has both a local dial plan and a non-local dial plan that together form the UDP. The local dial plan is set up at the local system as in earlier releases, using System Renumbering. The non-local dial plan is a list of up to 50 different extension number ranges for other systems in the private

network. When users call one another, the system searches the local dial plan; if the extension number is not found, it consults the non-local dial plan and associated routing information in order to send the call directly or indirectly to another system in the network. Routing information is programmed into as many as 20 *patterns* consisting of routes. Routes specify digit manipulation, pools, voice/data call type, and FRLs similar to those used for ARS.

**NOTE:**

In earlier releases, prior to 6.0, intersystem calls were made by dialing a pool access code followed by the extension number. With Release 6.0 and later systems, a reference list is programmed on the local system to find non-local extensions and direct calls to them.

When you specify a non-local extension range, the system verifies that extension numbers on the local system do not conflict with those programmed on a networked switch. For example, if Extension 110 exists in the local system, Extension 1100 cannot be included in the extension range for a non-local networked system. The local system also checks to see whether new extension number ranges conflict with existing ranges programmed for non-local systems.

**NOTE:**

The Non-Local UDP Administration Form in the Installation Specification should be kept accessible for programming. Contact your Lucent Technologies representative for a generated copy for your network.

When setting up your network for intersystem calling, keep the following important points in mind:

- You cannot program the local ARS access code or pool dial-out codes into non-local dial plan extension ranges; the system blocks this programming. Non-local extension range numbers cannot begin with the local ARS access code. If, for example, the ARS access code begins with 9 and a non-local dial plan extension range is 9230–9330, programming is blocked. You must not program the ARS access code of a non-local system into the non-local dial plan because it poses a security risk; it is best if all networked systems assign the same ARS access code.
- The Remote Access codes of non-local systems can be included in the non-local dial plan for the convenience of technicians providing technical support or for users to program their forwarding home extensions on a non-local system. Each system should use a unique and unambiguous Remote Access code.
- Your non-local dial plan programming has no effect on the remote system or systems it references. Local dial-plan changes made at a system do not automatically update the non-local dial plan numbering plans of networked systems. To avoid misrouting, it is recommended that manual adjustments

to the non-local dial plans made by network system managers be made at the same time. System managers should provide ranges wide enough to avoid problems for future non-local dial plan changes.

- In most cases, the extension numbers programmed into the non-local dial plan should be the same extension numbers that users at remote systems dial to reach one another within their systems. The main exception occurs when non-local dial plan numbers refer to extensions on DEFINITY ECS or DEFINITY ProLogix Solutions systems, which include five digits.
- Extensions included in ranges must be unique and unambiguous across systems. In other words, if the local system includes extension 112, that system blocks the programming of a non-local extension range that encompasses extension 1122. If it allowed the range, calls to 1122 would be misrouted because the system would send calls for extension 1122 to extension 112 as soon as it received the first three numbers. In this example, the local system prevents the numbering conflict. If the local system is connected to more than one other networked system, however, programmed extension ranges must assure proper routing. For example, if the manager on System A must program extension ranges on two connected systems, System B and C, the specified ranges on Systems B and C must be unique and unambiguous. If System B includes the range 2030–2049, System C cannot include an extension range that encompasses either extension 203 or extension 204.
- MERLIN LEGEND Communications System dial plans may include 2-digit, 3-digit, or 4-digit extension numbers. However, DEFINITY ECS or DEFINITY ProLogix Solutions users must dial four digits in order to reach a MERLIN LEGEND Communications System extension in a network. Although the MERLIN LEGEND Communications System can be programmed to drop digit or digits, use 4-digit dial plans in networks with DEFINITY ECS or DEFINITY ProLogix Solutions.
- When planning non-local extension ranges, PRI dial-plan routing and DID numbers must be considered. If calls are routed across the network to these numbers, they also must not conflict with extension ranges in other network systems. In addition, UDP routes must specify correct digit manipulation (deleting or adding digits). When such calls are routed to 5-digit DEFINITY ECS or DEFINITY ProLogix Solutions systems, special considerations apply.

MERLIN LEGEND Communications System non-local dial plan numbering specifies extensions up to four digits long, while DEFINITY ECS and DEFINITY ProLogix Solutions systems may have 5-digit extension numbers. There are two methods you can use to number DEFINITY ECS or DEFINITY ProLogix Solutions non-local dial plan ranges to match the five digits.

Choose one of the following techniques, depending upon the actual extension numbers you are entering in ranges and potential conflicts:

- Specify ranges in MERLIN LEGEND that include the first four digits in the extension numbers. Each number you enter in the range represents 10 numbers in the remote 5-digit system. For example, an extension range entered as 4321 through 4322 represents remote extensions 43210 through 43229. Users actually dial five digits. The local system recognizes the number range by the first four digits, but sends all five digits to the DEFINITY ECS or DEFINITY ProLogix Solutions system.
- Enter the last four digits and use UDP routing to prepend the first digit in the DEFINITY ECS or DEFINITY ProLogix Solutions extension number. The local system recognizes the number range using the last four digits. Users dial only the last four digits. If DID calls must reach 5-digit DEFINITY ECS or DEFINITY ProLogix Solutions extensions from a MERLIN LEGEND Communications System, this method of routing should be used. However, DID facilities should be connected directly to the local DEFINITY ECS or DEFINITY ProLogix Solutions systems.

Call Handling for Non-Local Dial Plan Extensions

When a local user dials a remote extension included in the non-local dial plan, he or she does so using an SA or Shared SA button. For the system user, the call is like a regular inside call.

The system takes the following steps in order to execute and direct the call:

1. The system consults the local dial plan to find the extension number. If the number is not in the local plan, it searches the non-local dial plan. When the called number is in the non-local plan, Step 2 takes effect.
2. Outward and toll restrictions assigned to the calling extension are disregarded so that the user can make this particular "outside" call. The extension's FRL is compared to the UDP route FRL. The extension FRL must be equal to or higher than the route FRL in order for the call to go through. If a remote access user is making the call or if the call is to a non-local remote access code programmed into the non-local dial plan, the barrier code FRL takes the place of the extension FRL.
3. The system locates the pattern associated with the extension number.
4. The system finds the lowest-numbered available route for the call, beginning with Route 1. If all available routes are busy, the caller may use Automatic or Selective Callback to queue for Route 1 on the local system.

5. The call is put through speedily. It may go through more than one system before it is completed. For example, if a user on System A calls Extension 4551, the non-local dial plan may send the call to System B. If 4551 is not in System B's local dial plan, it may be directed to a non-local dial plan extension—in System C, for example.
6. At the non-local dial plan extension, the call rings as an outside call. If the user at the remote networked system has an MLX or ETR display telephone and the call arrives on a PRI tandem trunk, the display can provide caller information even for 5-digit extension numbers, such as MILLS Ext49312. An MLS telephone shows OUTSIDE. The system manager programs display preferences to supply the extension number, programmed name label, or both.

**NOTES:**

- Users at MLX, ETR, or MLS display telephones can receive incoming call information for calls from non-local dial plan extensions, but only if the calls arrive on PRI tandem trunks. A display preference feature enables the display of extension number information, extension label (name) information, or both, at display telephones. For more information, see [“Display” on page 271](#).
- Non-local dial plan programming can be used to route an extension's calls to an outside number. This may be convenient when, for example, an extension user is working at home and wants to receive calls at a home telephone number.

Transfers with consultation can be made across the network, but they cannot be voice-announced. These transfers must be made using telephones; they cannot be made by CTI-linked PassageWay Telephony services clients. Transfers between extensions on different networked systems are actually trunk-to-trunk transfers. Although transfers to non-local dial plan extensions can be made regardless of trunk-to-trunk transfer prohibitions, such transfers made over tandem tie trunks behave like trunk-to-trunk transfers, providing no transfer returns. If the transfer is made over tandem PRI facilities and the non-local extension is unavailable, the call returns to the transfer originator if the intended destination is busy, invalid, or has Do Not Disturb active with no coverage.

UDP routing distributes intersystem calls among networked system users, as well as DID and PRI dial-plan routed calls that arrive from the public switched telephone network and are routed across the network. It allows the system manager to prioritize routes used for calls and to set up special routes—for example, distributing 2B data calls to remote videoconferencing systems. This routing is distinct from the ARS and Remote Access features used when extensions on one networked system make outside calls by using lines/trunks connected to another system in the same private network. For detailed information on setting up network tandem trunks, refer to the *Network Reference*.

Considerations and Constraints

Calls to a non-local dial plan extension are treated as outside calls for the purpose of conferencing. Each non-local conference participant who is added takes up one of the two outside calls permitted in a conference. For example, if a user has added two outside calls to a conference, it is not possible to add a non-local dial plan extension. Similarly, if two outside parties are already participating in a conference, and an attempt is made to add a third participant on the local switch, the local user can be added if he or she answers the call.

Trunk-to-trunk transfer restrictions assigned to extensions are not applied to the following types of calls:

- A call on a private network trunk transferred to a non-local dial plan extension.
- A call on an outside central office line/trunk transferred to a non-local dial plan extension.
- A call on a private network trunk transferred to an outside central office line/trunk.

Consult the *Network Reference* for information about restricting calls on extensions in a network. Note that if an extension receives an outside call transferred from a non-local extension over a tandem trunk, the user can then transfer this outside call to an outside PSTN facility, possibly bypassing intended restrictions.

In Release 6.0 and later systems, T1 channels can be programmed either to emulate voice tie trunks or data tie trunks. These can be used as tandem trunks linking networked systems. In addition, you can use drop-and-insert equipment to supply fractional T1 use; see the *Network Reference* for more information.

Telephone Differences

Queued Call Consoles

For Release 6.0 and earlier systems, an extension may not have its calls covered by a QCC on another system. In Release 6.1 and later systems (Hybrid/PBX mode only), a QCC can be the non-local extension that is the single non-local member in a calling group.

A QCC operator can manually extend an outside or non-local dial plan extension call to a local extension, non-local dial plan extension, or a destination outside the private network. If the destination is a non-local extension and the call extending (Join) is completed to a busy or invalid number, the transfer can be returned only if the Join took place over tandem PRI trunks. If the Join took place over tandem tie trunks, it is not returned in the event that the destination is busy or invalid.

A QCC Pool Status button shows activity on private network trunk pools as well as on other trunk pools.

A call from a non-local dial plan extension over tandem tie trunks is prioritized as an outside call to the QCC and treated as an outside call for the purpose of the Join function.

Direct-Line Consoles

To prevent toll fraud, private trunks should not be assigned as personal lines on a DLC, nor should a DLC be given dial access to private trunk pools.

Direct Station Selectors

In Release 6.0 and earlier systems, DSS buttons function only for local system extensions. In Release 6.1 and later systems (Hybrid/PBX mode only), DSS buttons can be pressed for non-local extensions. No busy indications, appear on the DSS for non-local extensions.

Single-Line Telephones

In Release 6.0 and later systems, single-line telephones can perform the same trunk-to-trunk transfers as other extensions, even though they are prohibited from making trunk-to-trunk transfers of inside or outside calls to local system trunks.

Feature Interactions

Account Code Entry	Account codes entered on the local system are reported by SMDR. Users can enter account codes for private network calls. When Forced Account Code Entry is programmed, a user can still dial a non-local extension without entering an account code.
Alarm	System alarms apply to the local system. The Alarm button on an operator console responds to the local system.
Auto Answer Intercom	Auto Answer Intercom does not work for calls on private network trunks.
Auto Dial	Non-local dial plan extension numbers can be programmed on outside Auto Dial buttons and not on inside Auto Dial buttons.
Automatic Route Selection	ARS access codes should not be assigned to the non-local dial plan. For example, if the ARS code is 9, extension ranges such as 9000–9039 should not be assigned.
Barge-In	Barge-In does not work for calls over the private network.

- Callback** Callback queuing works for lines/trunks connected to the caller's local system, including private network tandem trunks. When a call is sent across the network and a non-local extension or system's trunks are busy, the caller cannot queue the call using Callback.
- When an extension has Automatic Callback turned on and originates a call to a non-local extension, the call is queued at the local system for Route 1 only. If all routes are busy, the caller hears callback tone. If the caller is using ARS to call out over trunks connected to a remote system and the outside facilities at the remote system are busy, the caller hears the busy tone. The caller also hears the busy tone if he or she is calling a busy non-local dial plan extension. Neither call activates callback queueing because the caller is not connected to the system from which the busy condition originates.
- If a caller attempts Selective Callback upon hearing a busy tone and the busy condition is not derived from the originating system, Selective Callback has no effect. A caller can use Selective Callback to queue for Route 1 when all local routes for a networked call are busy.
- Caller ID** If a PRI tandem trunk conveys a call from the receiving system to a remote networked system without user intervention, Caller ID information is also conveyed. If the tandem trunk is an analog or digital tie trunk, no Caller ID information is sent to the remote system. If a Caller ID call is transferred from the receiving system to the remote system, no Caller ID information is conveyed.
- Calling Restrictions** Toll/outward restrictions and the prohibition of trunk-to-trunk transfers do not apply to calls made to extensions in the non-local dial plan.
- Dial-access to pools should not be permitted for pools of private trunks.
- Camp-On** Camp-On does not work for non-local dial plan extensions.
- Centralized Voice Messaging** In Release 6.1 and later systems (Hybrid/PBX only), the non-local integrated VMI calling group cannot be dialed directly. The local calling group that contains the non-local extension for the integrated VMI calling group is dialed instead. The system then sends the call to the remote system according to the route and pattern set up for that extension. See the *Network Reference* for details.
- Conference** Calls to a non-local dial plan extension are treated as outside calls for the purpose of conferencing. Each non-local conference participant who is added takes up one of the two outside calls permitted in a conference. For example, if a user has added two outside calls to a conference, it is not possible to add a non-local dial plan extension.

Coverage

Non-local UDP calls are treated as outside calls by the system and by Selective Coverage features: Coverage Off, Coverage Inside, and Coverage VMS Off.

In Release 6.0, calls cannot be covered by non-local extensions or non-local calling groups.

In Release 6.1 and later systems (Hybrid/PBX mode only), although calls cannot be sent directly to non-local extensions or calling groups for coverage, they can be sent to a local calling group that has a non-local calling group extension as its only member.

CTI Link

In a private network, operation for calls in PassageWay Telephony Services applications depends upon the application implementation as well as the type of private networked trunks (PRI or tie) that carry calls.

For an outgoing call, if the PassageWay Telephony Services application uses the length of a destination telephone number to differentiate PSTN calls from UDP calls, a PassageWay Telephony Services client displays a non-local extension call in the same way as it does inside calls.

For an outgoing call, if the PassageWay Telephony Services application uses receipt of the *Network Reached event* to differentiate PSTN calls from inside calls, a PassageWay Telephony Services client displays a non-local extension call or other UDP-routed call in the same way as it does an outside call made to the public switched telephone network.

For an incoming call, if the PassageWay Telephony Services application uses the length of ANI information to differentiate PSTN calls from UDP calls, a PassageWay Telephony Services client displays a non-local dial plan call as an inside call.

For an incoming PSTN call that enters the private network on a PRI trunk with an ANI of length shorter than seven digits and crosses PRI tandem trunks only, the recipient PassageWay Telephony Services client display depends on the PassageWay Telephony Services application implementation.

- If the PassageWay Telephony Services application does not strip leading zeros, the PassageWay Telephony Services client displays the ANI information with any leading zeros needed to make the information seven digits long.
- If the PassageWay Telephony Services application strips leading zeros, the recipient PassageWay Telephony Services client displays the ANI information in its original length. The call displays as an inside or outside call, depending on whether ANI information or a trunk identifier in the *delivered event* is used to differentiate the call.

If the non-local dial plan recipient of a transfer or conference call is a PassageWay Telephony Services client, the recipient's display shows caller information about the conference or transfer originator, not about

CTI Link
(continued)

any other caller. Users at CTI-linked PassageWay Telephony Services extensions must use the telephones at their extensions to make transfers to non-local dial plan extensions or to add conferees to a conference. They cannot use their PassageWay applications. A PassageWay Telephony Services client display does not provide an indication when a conferee is dropped.

Collected digits are not sent across the network.

Direct Voice Mail

Direct voice mail cannot be used for non-local dial plan extensions.

Directories

Non-local dial plan extensions cannot be included in a local Extension Directory.

Non-local dial plan extensions can be included in Personal and System Directories.

Use a remote networked system's System Directory cannot be used to make calls.

Display

PRI tandem trunks can provide label and extension number display at the destination MLX or ETR display telephone. The system manager programs this capability to allow display of the label (name), extension number, or both. The system supports the display of 5-digit DEFINITY ECS or DEFINITY ProLogix Solutions system extension numbers.

If an incoming PRI call with ANI is directed over PRI tandem trunks only, the trunk label and ANI information can display at the display telephone extension where the call arrives.

Tandem tie trunks do not support this display. Calls between networked systems on tie trunks display as outside calls do.

Display operation for Forwarding, redirected transfers, and returned transfers is generally not supported across a private network. When a call is transferred and travels over PRI tandem trunks, the display shows the transferring extension. A forwarded call arriving at a remote extension displays as though the caller had reached the extension directly.

Forward and Follow Me

Follow Me is not supported across a private network.

In Release 6.0 (Hybrid/PBX mode only), Forward is not supported across a private network.

In Release 6.1 and later systems (Hybrid/PBX mode only), Forward is supported across a private network.

Consider the following: A BRI call comes in to System A and is forwarded with no Forward Delay over tie lines with E&M signaling to a non-local extension on System B. If the extension on System B does not answer the call within one or two rings, the call is dropped. To solve the problem, set Forward Delay to at least one ring so that System B waits for a ring signal before it disconnects from the call.

Group Calling

Private-networked trunks cannot be programmed to ring into calling groups because tandem trunks are dial-in facilities.

When a calling group extension number is included in the non-local dial plan, you can dial the group just as you would any other extension. Calls can be transferred to non-local calling groups.

In Release 6.0 systems (Hybrid/PBX mode only), all calling group members, the supervisor, alerts, delay announcement devices, and overflow receivers must be located on the same system.

In Release 6.1 and later systems (Hybrid/PBX mode only), coverage and overflow can be directed to a calling group that contains a single non-local extension number.

Calls-in-Queue Alarm buttons and alerts, as well as delay announcement devices work only for calling groups on the local system.

HFAI

The HFAI button does not work for calls from non-local dial plan extensions.

HotLine

You cannot assign a non-local extension for HotLine operation. A HotLine extension, however, can be used to dial a non-local extension.

Labeling

For incoming calls, the alphanumeric label and/or extension number for non-local dial plan extensions appears on local system MLX and ETR displays according to display preference programming. This feature works only when PRI tandem trunks convey the calls.

When operators make intersystem calls, you should relabel the default OPERATR label to distinguish operators in different systems.

In Release 6.0 and later systems (Hybrid/PBX mode only), the system supports the display of DEFINITY ECS or DEFINITY ProLogix Solutions extension labels, although long DEFINITY ECS or DEFINITY ProLogix Solutions labels may be truncated on MERLIN LEGEND Communications System MLX and ETR displays, which support a maximum of seven characters for name labels and seven characters for extension number labels.

Messaging

Messaging features generally do not work across a private network. They only work for extensions connected to the same system.

A user cannot turn a message light at a non-local dial plan extension off or on. Only an integrated VMI port can turn a message light on or off across a private network (Release 6.1 and later systems).

An operator cannot inspect the message status of an extension.

Music-On-Hold	<p>Music-On-Hold sources cannot be shared by networked systems.</p> <p>Calls between systems in a private network are treated as outside calls; for this reason, callers hear Music-On-Hold as though they were outside callers.</p>
Night Service	<p>All Night Service group extensions and lines must be on the local switch, as must be any Night Service alerts.</p> <p>If Night Service is programmed with outward restriction, the restriction does not apply to non-local dial plan calls. Exclusion lists do not apply to intersystem calls.</p> <p>During Night Service operation, a user can call into a shared remote access trunk and use remote access to reach non-local extensions.</p> <p>During Night Service operation, an intersystem call to a member of a Night Service group rings at all member extensions.</p> <p>Transitions into and out of Night Service must be made locally. For example, an operator cannot turn on Night Service at a remote system.</p> <p>Private trunks should not be assigned to a Night Service group.</p> <p>In Release 6.1 and later systems (Hybrid/PBX mode only), Night Service coverage can be provided across a private network to a centralized Automated Attendant, a non-local calling group, a QCC queue, a DLC, or any individual extension on the remote system.</p>
Paging	<p>Loudspeaker and voice paging calls cannot be made to non-local dial plan extensions or paging groups.</p>
Park	<p>Park zones must be in the local system. Calls cannot be parked at remote park zones.</p>
Personal Lines	<p>Private networked trunks should not be assigned to extensions as personal lines.</p>
Pickup	<p>A call at a non-local extension cannot be picked up.</p>
Pools	<p>All private trunks must be assigned to pools of trunks that are of the same type (PRI, analog tie, T1-emulated tie voice, or T1 Switched 56). For security and speed reasons, dial access and Pool button access to these pools should not be permitted.</p> <p>Pool Status buttons show the busy or not-busy status of private trunk pools and outside trunk pools.</p> <p>When PRI tandem trunks are available, their pools should be assigned as Route 1 for the purpose of UDP routing.</p>

Features

Uniform Dial Plan Features

755

Reminder Service	Reminder Service does not function across a private network.
Service Observing	In Release 6.1 and later systems, calls coming across a private network can be observed just like outside calls. A Service Observer cannot observe non-local extensions.
Signal/Notify	These features do not function across a private network.
SMDR	<p>SMDR reports may report calls using more than one call record. Depending upon how SMDR is programmed and how calls are routed, you may need to consult several SMDR records in order to trace a call that is routed over network trunks. All network calls are reported according to SMDR programming for reporting incoming and outgoing calls. For network calls, outgoing call records report the incoming tandem trunk number in the STN. field; dialed digits shown on the report do not reflect any digit manipulation (addition or absorption) performed by the local system.</p> <p>Ensure that the system date and time are set accurately on each system that carries network calls. When reviewing reports, consider any time zone differences among networked systems.</p>
Speed Dial	<p>Non-local dial plan numbers can be programmed as speed dial numbers.</p> <p>System Speed Dial numbers can only be accessed by local system users.</p>
System Renumbering	A separate numbering plan is provided for non-local dial plan extensions, allowing system managers to enter the ranges of extensions on remote systems. These ranges are associated with patterns that in turn allow routing over private tandem trunks or over PSTN facilities when appropriate. Programming remote extension ranges does not affect the remote system or the extension numbering used within the remote system. When a system is renumbered to the factory-set default, non-local dial plan extension ranges are deleted.
Transfer	Transfers to non-local dial plan extensions are actually trunk-to-trunk transfers. Most extensions, including those equipped with single-line telephones, can make these calls, even if trunk-to-trunk transfers are prohibited. The incoming call must be on a trunk with reliable disconnect. If a private network trunk is not available to carry the transferring call, it can be callback-queued.

Local users can make the types of calls listed below, regardless of system programming for trunk-to-trunk transfers:

- A call on a private network trunk transferred to a non-local dial plan extension.
- A call on an outside central office line/trunk transferred to a non-local dial plan extension.
- A call on a private network trunk transferred to an outside central office line/trunk.

Other trunk-to-trunk transfers are prohibited. If the system manager has prohibited an extension from making trunk-to-trunk transfers, it is still prevented from transferring inside or outside calls to another local system trunk connected to the public switched telephone network.

Consult the *Network Reference* for information about restricting calls on extensions in a network. Note that if an extension receives an outside call transferred from a non-local extension over a tandem trunk, the user can then transfer this outside call to an outside PSTN facility, possibly bypassing intended restrictions.

Most transfer functions operate normally between local and non-local dial plan extensions, except when transfers are performed by or received by PassageWay Telephony Services clients with a CTI link. A call transferred to a non-local dial plan extension with an MLX or ETR display telephone, however, does not receive the same call information that an inside transfer does. Only the extension number and label (if programmed) of the transferring extension are shown.

Transfers across networked systems only return to the transferring extension if the transfer is routed over tandem PRI facilities. If a call is transferred to a busy or invalid non-local dial plan extension over tandem tie trunks, the transfer originator hears a busy tone and must hang up and call back in order to speak with someone.

Voice Announce

At a Glance

Users Affected	Telephone users, DLC operators
Reports Affected	Extension Directory, Extension Information
Modes	All
Telephones	All telephones with speakerphones
Programming Codes	
Receive On	*10
Receive Off	**10
On Idle Only	*130
MLX Display Labels	Voice Annce ,Receive ,On [Voice ,Recv ,On] Voice Annce ,Receive ,Off [Voice ,Recv ,Off]
System Programming	Turn on/off Voice Announce for analog multiline telephones: ■ Extensions→VoiceSignl Enable or disable Voice Announce for QCCs: ■ Operator→Queued Call→More→Voice Ann
Factory Settings	
Analog multiline Voice Announce	On
QCC Voice Announce	Disabled

Description

Voice Announce allows MLX, ETR, MLS, and analog multiline telephone users to receive inside calls on their speakerphones. MLX and analog multiline telephone users can receive a voice-announced call even if they are already on a call. A telephone user can turn off all incoming voice announcements, calls made from an SA Voice or ICOM Voice button on another extension, or group pages.



NOTE:

Analog multiline telephones must have bridged jacks on the extension module to receive Voice Announce calls when the telephone is already in use.

When Voice Announce is on at an extension, an inside caller can reach that extension by speaking on its speakerphone. When Voice Announce is turned off at an extension, no caller can turn on that extension's speakerphone. The user at that extension, however, can still make calls and speak on the speakerphone.

Beginning in Release 7.0, Voice Announce on Idle Only is available for MLX telephones. This further enhancement to the Voice Announce feature allows you to receive voice announcements only when you are not active on another call.

For a telephone to receive a Voice Announce call when the telephone is already busy, two communications channels are required between the control unit and the telephone, one for voice-announced calls and one for ringing calls. Turning off the feature at an extension converts the second, voice-announced channel into a ringing channel. Calls made to the extension as voice-announced calls arrive as ringing calls instead.



NOTE:

ETR and MLS telephones only support one communications channel on the MERLIN LEGEND System and therefore cannot receive Voice Announce calls when the telephone is in use.

For an MLX telephone, the ability to receive Voice Announce calls when the telephone is busy is automatically available because the MLX extension jack provides two communications channels. For an analog multiline telephone, allowing the telephone to receive Voice Announce calls when the telephone is busy requires assigning two consecutive extension jacks to the telephone. The extension assigned to the odd-numbered jack is the telephone's extension; the extension assigned to the next higher even-numbered jack is used for voice announcements and cannot be dialed. A single-line telephone cannot receive voice-announced calls even if the set has a speakerphone.

When a caller makes a voice-announced call to an extension with Voice Announce, the caller hears a tone. The called person hears a beep and the caller's voice over the speakerphone unless one of the following is true:

- The called person is already using the speakerphone. In this case, the caller hears ringback, and the called person hears an abbreviated ring, if programmed.
- The called person has turned off Voice Announce. In this case, the caller hears ringback, and the called person hears ringing for an inside call.
- The called person has turned on Do Not Disturb. The caller hears a busy signal and, if the caller has a display telephone, sees the message **DO NOT DISTURB**.

QCC Voice Announce

In Release 4.0 and later releases, if QCC Voice Announce is Enabled, then the fifth Call button on QCCs can be used to announce a call on another user's speakerphone. If Voice Announce is disabled (factory setting), then the fifth Call button functions the same as any other Call button. This setting applies to all

QCCs in the system. Inspecting this button displays `Call 5 Voice` if Voice Announce for QCCs is enabled and `Call 5 Ring` if Voice Announce for QCCs is not enabled.

QCCs *cannot* receive Voice Announce calls. Any call to a QCC from a Voice Announce SA button from another extension is received at the QCC as a ringing call.

Considerations and Constraints

By turning off Voice Announce, MLX, ETR, MLS, and analog multiline telephone users can prohibit all voice announcements to their telephones. When a user turns off Voice Announce, the Hands Free Answer on Intercom (HFAI) capability is also turned off.

By selecting Voice Announce on Idle Only, an MLX telephone user receives voice announcements only when there is no active call at the telephone.

Voice Announce should be turned off at data workstations that include either an MLX telephone or an analog multiline telephone, a GPA, and a modem.

Telephone Differences

Queued Call Consoles

If QCC Voice Announce is Enabled, Voice Announce calls can be made by choosing the fifth Call button on the console.

QCCs *cannot* receive Voice Announce calls. Any call to a QCC from a Voice Announce SA button from another extension is received at the QCC as a ringing call.

Other Multiline Telephones

Voice Announce is available on MLX, ETR, MLS, and analog multiline telephones.

Receiving Voice Announce calls when the telephone is busy is automatic on an MLX telephone. An analog multiline telephone requires an additional extension jack for the feature. ETR and MLS telephones cannot receive a Voice Announce call when the telephone is already in use.

MLC-5, MDC 9000, and MDW 9000 cordless and cordless/wireless telephones cannot receive voice-announced calls. Voice Announce, however, is not automatically turned off for this type of telephone. If a multiline telephone user tries to make a voice-announced call to a cordless telephone on which Voice

Announce has not been turned off, the cordless telephone beeps. The user can then answer the call using the handset.

Single-Line Telephones

Single-line telephone users cannot make or receive voice announcements, even if the set has a speakerphone.

Feature Interactions

Coverage	An inside voice-announced call is not sent to coverage because, if the sender's speakerphone is available, the call is answered as soon as it is made. If the sender's speakerphone is in use, the call is converted to a ringing call and sent to coverage.
Digital Data Calls	Voice Announce should be disabled at digital data workstations.
Do Not Disturb	A user with Do Not Disturb on does not receive voice announcements.
HFAI	When Voice Announce is turned on, HFAI is disabled.
Microphone Disable	Users who are on their telephones and whose microphones are disabled can still hear a voice-announced call over the speakerphone. They must press the button with the incoming call and use the handset to talk to the caller.
Multi-Function Module	Voice Announce interferes with data calls made through a device attached to an MFM.
Paging	Users who program their extensions to turn off Voice Announce do not receive individual or group speakerphone pages. A user with an MLX telephone with Voice Announce to Idle Only on (Release 7.0 and later systems) does not receive pages when he or she is active on a call.

Customer Support Information



Support Telephone Number

In the USA only, Lucent Technologies provides a toll-tree customer Helpline (1-800-628-2888) 24 hours a day. If you need assistance when installing, programming, or using your system, call the Helpline or your Lucent Technologies representative. Consultation charges may apply.

Outside the USA, if you need assistance when installing, programming, or using your system, contact your Lucent Technologies representative.

Federal Communications Commission (FCC) Electromagnetic Interference Information

This equipment has been tested and found to comply with the limits for a Class A digital device, pursuant to Part 15 of the FCC Rules. These limits are designed to provide reasonable protection against harmful interference when the equipment is operated in a commercial environment. This equipment generates, uses, and can radiate radio frequency energy and, if not installed and used in accordance with the instruction manual, may cause harmful interference to radio communications. Operation of this equipment in a residential area is likely to cause harmful interference, in which case the user will be required to correct the interference at his or her own expense.

Canadian Department of Communications (DOC) Interference Information

This digital apparatus does not exceed the Class A limits for radio noise emissions set out in the radio interference regulations of the Canadian Department of Communications.

Le Présent Appareil Numérique n'émet pas de bruits radioélectriques dépassant les limites applicables aux appareils numériques de la classe A prescrites dans le règlement sur le brouillage radioélectrique édicté par le ministère des Communications du Canada.

FCC Notification and Repair Information

This equipment is registered with the FCC in accordance with Part 68 of its rules. In compliance with those rules, you are advised of the following:

- **Means of Connection.** Connection of this equipment to the telephone network shall be through a standard network interface jack, USOC RJ11C, RJ14C, or RJ21X. Connection to E&M tie trunks requires a USOC RJ2GX. Connection to off-premises extensions requires a USOC RJ11C or RJ14C. Connection to 1.544-Mbps digital facilities must be through a USOC RJ48C or RJ48X. Connection to DID requires a USOC RJ11C, RJ14C, or RJ21X. These USOCs must be ordered from your telephone company. Connection to 56-KBps or 64-KBps facilities requires a USOC RJ11C, RJ14C, or RJ21.
- **Party Lines and Coin Telephones.** This equipment may not be used with party lines or coin telephone lines.
- **Notification to the Telephone Companies.** Before connecting this equipment, you or your equipment supplier must notify your local telephone company's business office of the following:
 - The telephone number or numbers you will be using with this equipment.
 - The appropriate registration number and ringer equivalence number (REN), which can be found on the back or bottom of the control unit, as follows:
 - If this equipment is to be used as a Key system, report the number AS593M-72914-KF-E.

- If the system provides both manual and automatic selection of incoming/outgoing access to the network, report the number AS593M-72682-MF-E.
 - If there are no directly terminated trunks, or if the only directly terminated facilities are personal lines, report the number AS5USA-65646-PF-E.
 - The REN (Ringer Equivalence Number) for all three systems is 1.5A.
- The facility interface code (FIC) and service order code (SOC): For tie line connection, the FIC is TL31M and the SOC is 9.0F.
- For connection to off-premises stations, the FIC is OL13C and the SOC is 9.0F.
 - For equipment to be connected to DID facilities, the FIC is 02RV2-T and the SOC is AS.2.
 - For equipment to be connected to 1.544-MBps digital service, the SOC is 6.0P and the FIC is:
 - 04DU9-BN for D4 framing format with AMI zero code suppression.
 - 04DU9-DN for D4 framing format with bipolar 8 zero code suppression (B8ZS).04DU9-IKN for extended superframe format (ESF) with AMI zero code suppression.
 - 04DU9-ISN with ESF and B8ZS.
 - For equipment to be connected to 56-KBps or 64-KBps digital facilities, the FIC is 02B1Q.
- The quantities and USOC numbers of the jacks required.
- For each jack, the sequence in which lines are to be connected, the line types, the FIC, and the REN by position, when applicable.
- **Ringer Equivalence Number (REN).** The REN is used to determine the number of devices that may be connected to the telephone line. Excessive RENs on the line may result in the devices not ringing in response to an incoming call. In most, but not all, areas, the sum of the RENs should not exceed five (5.0). To be certain of the number of devices that may be connected to the line, as determined by the total RENs, contact the local telephone company to determine the maximum REN for the calling area.
 - **Disconnection.** You must also notify your local telephone company if and when this equipment is permanently disconnected from the line or lines.

Installation and Operational Procedures

The guides for your system contain information about installation and operational procedures.

- **Repair Instructions.** If you experience trouble because your equipment is malfunctioning, the FCC requires that the equipment not be used and that it be disconnected from the network until the problem has been corrected. Repairs to this equipment can be made only by the manufacturers, their authorized agents, or others who may be authorized by the FCC. In the event repairs are needed on this equipment, contact your authorized Lucent Technologies dealer or, **in the USA only**, contact the National Service Assistance Center (NSAC) at 1-800-628-2888.
- **Rights of the Local Telephone Company.** If this equipment causes harm to the telephone network, the local telephone company may discontinue your service temporarily. If possible, they will notify you in advance. But if advance notice is not practical, you will be notified as soon as possible. You will also be informed of your right to file a complaint with the FCC.
- **Changes at Local Telephone Company.** Your local telephone company may make changes in its facilities, equipment, operations, or procedures that affect the proper functioning of this equipment. If they do, you will be notified in advance to give you an opportunity to maintain uninterrupted telephone service.
- **Hearing Aid Compatibility.** The custom telephone sets for this system are compatible with inductively coupled hearing aids as prescribed by the FCC.
- **Automatic Dialers.** WHEN PROGRAMMING EMERGENCY NUMBERS AND/OR MAKING TEST CALLS TO EMERGENCY NUMBERS:
 - Remain on the line and briefly explain to the dispatcher the reason for the call.
 - Perform such activities in off-peak hours, such as early morning or late evening.
- **Direct Inward Dialing (DID).** This equipment returns answer supervision signals to the Public Switched Telephone Network when:
 - Answered by the called station.
 - Answered by the attendant.
 - Routed to a recorded announcement that can be administered by the customer premises equipment user.
 - Routed to a dial prompt.

This equipment returns answer supervision on all DID calls forwarded back to the Public Switched Telephone Network. Permissible exceptions are when:

- A call is unanswered.
- A busy tone is received.
- A reorder tone is received.

Allowing this equipment to be operated in such a manner as not to provide proper answer supervision signaling is in violation of Part 68 rules.

New Network Area and Exchange Codes. The MERLIN LEGEND Communications System software does not restrict access to any new area codes or exchange codes established by a local telephone company. If the user has established toll restrictions on the system that could restrict access, then the user should check the lists of allowed and disallowed dial codes and modify them as needed.

Equal Access Codes. This equipment is capable of providing users access to interstate providers of operator services through the use of access codes. Modifications of this equipment by call aggregators to block access dialing codes is a violation of the Telephone Operator Consumers Act of 1990.

DOC Notification and Repair Information

NOTICE: The Canadian Department of Communications (DOC) label identifies certified equipment. This certification means that the equipment meets certain protective, operational, and safety requirements of the telecommunications network. The DOC does not guarantee the equipment will operate to the user's satisfaction.

Before installing this equipment, users should ensure that it is permissible to connect it to the facilities of the local telecommunications company. The equipment must also be installed using an acceptable method of connection. In some cases, the company's inside wiring for single-line individual service may be extended by means of a certified connector assembly (telephone extension cord). The customer should be aware that compliance with the above conditions may not prevent degradation of service in some situations.

Repairs to certified equipment should be made by an authorized Canadian maintenance facility designated by the supplier. Any repairs or alterations made by the user to this equipment, or any equipment malfunctions, may give the telecommunications company cause to request the user to disconnect the equipment.

Users should ensure, for their own protection, that the electrical ground connections of the power utility, telephone lines, and internal metallic water pipe system, if present, are connected. This precaution may be particularly important in rural areas.



CAUTION:

Users should not attempt to make such connections themselves, but should contact the appropriate electrical inspection authority or electrician.

To prevent overloading, the Load Number (LN) assigned to each terminal device denotes the percentage of the total load to be connected to a telephone loop used by the device. The termination on a loop may consist of any combination of devices subject only to the requirement that the total of the Load Numbers of all the devices does not exceed 100.

DOC Certification No.: 230 4095A

CSA Certification No.: LR 56260

Load No.: 6

Renseignements sur la Notification du Ministère des Communications du Canada et la Réparation

AVIS: L'étiquette du ministère des Communications du Canada identifie le matériel homologué. Cette étiquette certifie que le matériel est conforme à certaines normes de protection, d'exploitation et de sécurité des réseaux de télécommunications. Le Ministère n'assure toutefois pas que le matériel fonctionnera à la satisfaction de l'utilisateur.

Avant d'installer ce matériel, l'utilisateur doit s'assurer qu'il est permis de le raccorder aux installations de l'entreprise locale de télécommunication. Le matériel doit également être installé en suivant une méthode acceptée de raccordement. Dans certains cas, les fils intérieurs de l'entreprise utilisés pour un service individuel à ligne unique peuvent être prolongés au moyen d'un dispositif homologué de raccordement (cordon prolongateur téléphonique interne). L'abonné ne doit pas oublier qu'il est possible que la conformité aux conditions énoncées ci-dessus n'empêchent pas la dégradation du service dans certaines situations. Actuellement, les entreprises de télécommunication ne permettent pas que l'on raccorde leur matériel à des jacks d'abonné, sauf dans les cas précis prévus par les tarifs particuliers de ces entreprises.

Les réparations de matériel homologué doivent être effectuées par un centre d'entretien canadien autorisé désigné par le fournisseur. La compagnie de télécommunications peut demander à l'utilisateur de débrancher un appareil à la

suite de réparations ou de modifications effectuées par l'utilisateur ou à cause de mauvais fonctionnement.

Pour sa propre protection, l'utilisateur doit s'assurer que tous les fils de mise à la terre de la source d'énergie électrique, des lignes téléphoniques et des canalisations d'eau métalliques, s'il y en a, sont raccordés ensemble. Cette précaution est particulièrement importante dans les régions rurales.

AVERTISSEMENT: L'utilisateur ne doit pas tenter de faire ces raccordements lui-même; il doit avoir recours à un service d'inspection des installations électriques, ou à un électricien, selon le cas.

L'indice de charge (IC) assigné à chaque dispositif terminal indique, pour éviter toute surcharge, le pourcentage de la charge totale qui peut être raccordée à un circuit téléphonique bouclé utilisé par ce dispositif. La terminaison du circuit bouclé peut être constituée de n'importe quelle combinaison de dispositifs, pourvu que la somme des indices de charge de l'ensemble des dispositifs ne dépasse pas 100.

No d'homologation: 230 4095A

No de certification: CSA LR 56260



L'indice de charge: 6

**MERLIN LEGEND D.O.C.
Location Label Placement**

**Ministère des Communications
du Canada emplacement de
l'étiquette**

Lucent  **MERLIN LEGEND**

Model 511A Control Unit

UL LISTED 538E  **TELEPHONE EQUIPMENT**  LR 56260

MADE IN U.S.A.

This device complies with Part 15 of the FCC Rules. Operation is subject to the following two conditions: (1) this device may not cause harmful interference, and (2) this device must accept any interference received, including interference that may cause undesired operation.

Complies with Part 68, FCC Rules. See the System Reference Manual for proper FCC Classification.
FCC Reg. Nos. MF: AS93M-7282-MF-E
KF: AS93M-7291-KF-E
PF: ASSUSA-65846-PF-E
REN: 1.5A

CANADA

DR ID

WARNING: If equipment is used for out-of-building applications, approved secondary protectors are required. See Installation Manual.

AVERTISSEMENT: Si l'équipement est utilisé pour des applications extérieures, l'installation d'un protecteur secondaire est requise. Voir le manuel d'installation.

Use only Lucent Technologies manufactured MERLIN LEGEND circuit modules, carrier assemblies, and power units, as specified in the Installation Manual, in this product. There are no user serviceable parts inside. Contact your authorized agent for service and repair.

This digital apparatus does not exceed the Class A limits for radio noise emissions set out in the radio interference regulations of the Canadian Department of Communications.

Le présent appareil numérique n'émet pas de bruits radioélectriques dépassant les limites applicables aux appareils numériques de la classe A prescrites dans le Règlement sur le brouillage radioélectrique édicté par le ministère des Communications du Canada.

Security of Your System: Preventing Toll Fraud

As a customer of a new telephone system, you should be aware that there is an increasing problem of telephone toll fraud. Telephone toll fraud can occur in many forms, despite the numerous efforts of telephone companies and telephone equipment manufacturers to control it. Some individuals use electronic devices to

prevent or falsify records of these calls. Others charge calls to someone else's number by illegally using lost or stolen calling cards, billing innocent parties, clipping on to someone else's line, and breaking into someone else's telephone equipment physically or electronically. In certain instances, unauthorized individuals make connections to the telephone network through the use of the Remote Access features of your system.

The Remote Access features of your system, if you choose to use them, permit off-premises callers to access the system from a remote telephone by using a telephone number with or without a barrier code. The system returns an acknowledgment, signaling the user to key in his or her barrier code, which is selected and administered by the system manager. After the barrier code is accepted, the system returns dial tone to the user. In Release 3.1 and later systems, barrier codes are, by default, restricted from making outside calls. In prior releases, if you do not program specific outward calling restrictions, the user is able to place any call normally dialed from a telephone associated with the system. Such an off-premises network call is originated at, and will be billed from, the system location.

The Remote Access feature, as designed, helps the customer, through proper administration, to minimize the ability of unauthorized persons to gain access to the network. Most commonly, telephone numbers and codes are compromised when overheard in a public location, through theft of a wallet or purse containing access information, or through carelessness (for example, writing codes on a piece of paper and improperly discarding it). Additionally, hackers may use a computer to dial an access code and then publish the information to other hackers. Enormous charges can be run up quickly. It is the customer's responsibility to take the appropriate steps to properly implement the features, evaluate and administer the various restriction levels, protect access codes, and distribute access codes only to individuals who have been fully advised of the sensitive nature of the access information.

Common carriers are required by law to collect their tariffed charges. While these charges are fraudulent charges made by persons with criminal intent, applicable tariffs state that the customer of record is responsible for payment of all long-distance or other network charges. Lucent Technologies cannot be responsible for such charges and will not make any allowance or give any credit for charges that result from unauthorized access.

To minimize the risk of unauthorized access to your communications system:

- Use an unpublished Remote Access number.
- Assign access codes randomly to users on a need-to-have basis, keeping a log of *all* authorized users and assigning one code to each person.
- Use random-sequence access codes, which are less likely to be broken.
- Use the longest-length access codes the system will allow.

- Deactivate all unassigned codes promptly.
- Ensure that Remote Access users are aware of their responsibility to keep the telephone number and any access codes secure.
- When possible, restrict the off-network capability of off-premises callers, using calling restrictions, Facility Restriction Levels (Hybrid/PBX mode only), and Disallowed List capabilities. In Release 3.1 and later systems, a prepared Disallowed List (number 7) is provided and is designed to prevent the types of calls that toll-fraud abusers often make.
- When possible, block out-of-hours calling.
- Frequently monitor system call detail reports for quicker detection of any unauthorized or abnormal calling patterns.
- Limit Remote Call Forwarding to persons on a need-to-have basis.
- Change access codes every 90 days.
- Use the longest-length barrier codes possible, following the guidelines for passwords. (See [“Choosing Passwords” on page A-19.](#))

Toll Fraud Prevention

Toll fraud is the unauthorized use of your telecommunications system by third parties to make long-distance telephone calls. Under the law, you, the customer, are responsible for paying part or all of those unauthorized calls. Thus, the following information is of critical importance.

Unauthorized persons concentrate their activities in two areas with the MERLIN LEGEND Communications System:

- They try to transfer out of the MERLIN LEGEND Communications System to gain access to an outgoing trunk and make long-distance calls.
- They try to locate unused or unprotected mailboxes and use them as drop-off points for their own messages.

The following is a discussion of how toll fraud is often perpetrated and ways to prevent unauthorized access that can lead to toll fraud.

Physical Security, Social Engineering, and General Security Measures

Criminals called hackers may attempt to gain unauthorized access to your communications system and voice messaging system in order to use the system features. Hackers often attempt to trick employees into providing them with access to a network facility (line/trunk) or a network operator. This is referred to as social engineering. Hackers may pose as telephone company employees or

employees of Lucent Technologies or your authorized dealer. Hackers will go through a company's trash to find directories, dialing instructions, and other information that will enable them to break into the system. The more knowledgeable they appear to be about the employee names, departments, telephone numbers, and the internal procedures of your company, the more likely it is that they will be able to trick an employee into helping them.

Preventive Measures

Take the following preventive measures to limit the risk of unauthorized access by hackers:

- Provide good physical security for the room containing your telecommunications equipment and the room with administrative tools, records, and system manager information. These areas should be locked when not attended.
- Provide a secure trash disposal for all sensitive information, including telephone directories, call accounting records, or anything that may supply information about your communications system. This trash should be shredded.
- Educate employees that hackers may try to trick them into providing them with dial tone or dialing a number for them. All reports of trouble, requests for moving extensions, or any other administrative details associated with the MERLINs LEGEND Communications System should be handled by one person (the system manager) or within a specified department. Anyone claiming to be a telephone company representative should be referred to this person or department.
- No one outside of Lucent Technologies needs to use the MERLIN LEGEND Communications System to test facilities (lines/trunks). If a caller claims to be a Lucent Technologies employee, the system manager should ask for a telephone number where the caller can be reached. The system manager should be able to recognize the number as a Lucent Technologies telephone number. *Before connecting the caller to the administrative port of the MERLIN LEGEND Communications System, the system manager should feel comfortable that a good reason to do so exists.* In any event, it is not advisable to give anyone access to network facilities or operators, or to dial a number at the request of the caller.
- Any time a call appears to be suspicious, call the Lucent Technologies BCS Fraud Intervention Center at 1-800-628-2888 (fraud intervention for System 25, PARTNER[®] and MERLIN Systems).
- Customers should also take advantage of Lucent Technologies monitoring services and devices, such as the NetPROTECTSM family of fraud-detection services, CAS with HackerTracker[®], and CAT Terminal with Watchdog. Call 1-800-638-7233 to get more information on these Lucent Technologies fraud detection services and products.

Security Risks Associated with Transferring through Voice Messaging Systems

Toll fraud hackers try to dial into a voice mailbox and then execute a transfer by dialing *T. The hacker then dials an access code (either 9 for Automatic Route Selection or a pooled facility code), followed by the appropriate digit string to either direct dial or access a network operator to complete the call.



NOTE:

In Release 3.1 and later systems, all extensions are initially, and by default, restricted from dial access to pools. In order for an extension to use a pool to access an outside line/trunk, this restriction must be removed.

Preventive Measures

Take the following preventive measures to limit the risk of unauthorized transfers by hackers:

- Outward restrict all MERLIN LEGEND Communications System voice mail port extension numbers. This denies access to facilities (lines/trunks). In Release 3.1 and later systems, voice mail ports are, by default, outward restricted.
- As an additional security step, network dialing for all extensions, including voice mail port extensions, should be processed through ARS using dial access code 9.



SECURITY ALERT:

*The MERLIN LEGEND Communications System ships with ARS activated with all extensions set to Facility Restriction Level 3, allowing all international calling. **To prevent toll fraud**, ARS Facility Restriction Levels (FRLs) should be established using:*

- FRL 0 for restriction to internal dialing only.
- FRL 2 for restriction to local network calling only.
- FRL 3 for restriction to domestic long-distance (excluding area code 809 for the Dominican Republic as this is part of the North American Numbering Plan, unless 809 is required).
- FRL 4 for international calling.



WARNING:

In Release 3.1 and later systems, default local and default toll tables are factory-assigned an FRL of 2. This simplifies the task of restricting extensions: the FRL for an extension merely needs to be changed from the default of 3.



WARNING:

Each extension should be assigned the appropriate FRL to match its calling requirements. All voice mail port extensions not used for Outcalling should be assigned to FRL 0 (the default setting in Release 3.1 and later).

- Deny access to pooled facility codes by removing pool dial-out codes 70, 890–899, or any others on your system.
- Create a Disallowed List or use the pre-prepared Disallowed List number 7 (Release 3.1 and later systems only) to disallow dialing 0, 11, 10, 1700, 1809, 1900, and 976 or 1 (wildcard) 976. In Release 3.1 and later systems, Disallowed List number 7 does not include 800, 1800, 411, and 1411, but Lucent Technologies recommends that you add them.



NOTE:

Assign all voice mail port extensions to this Disallowed List. Lucent Technologies recommends assigning Disallowed List number 7. This is an added layer of security, in case outward restriction is inadvertently removed. (In Release 3.1 and later systems, voice messaging ports are assigned, by default, to Disallowed List number 7.)

If Outcalling is required by voice messaging system extensions:

- Program an ARS Facility Restriction Level (FRL) of 2 on voice mail port extensions used for Outcalling.
- If 800 and 411 numbers are used, remove 1800, 800, 411, and 1411 from Disallowed List number 7.
- If Outcalling is allowed to long-distance numbers, build an Allowed List for the voice mail port extensions used for Outcalling. This list should contain the area code and the first three digits of the local exchange telephone numbers to be allowed.

Additional general security for voice messaging systems:

- Use a secure password for the General Mailboxes.
- The default administration mailbox, 9997, must be reassigned to the system manager's mailbox/extension number and securely password protected.
- All voice messaging system users must use secure passwords known only to the user.

Security Risks Associated with the Automated Attendant Feature of Voice Messaging Systems

Two areas of toll fraud risk associated with the Automated Attendant feature of voice messaging systems are:

- Pooled facility (line/trunk) access codes are translated to a menu prompt to allow Remote Access. If a hacker finds this prompt, the hacker has immediate access. (In Release 3.1 and later systems, dial access to pools is initially factory-set to restrict all extensions: to allow pool access, this restriction must be removed by the system manager.)
- If the Automated Attendant prompts callers to use Remote Call Forwarding (RCF) to reach an outside telephone number, the system may be susceptible to toll fraud. An example of this application is a menu or submenu that says, "To reach our answering service, select prompt number 5," and transfers a caller to an external telephone number.

Remote Call Forwarding can be used securely only when the central office provides "reliable disconnect" (sometimes referred to as forward disconnect or disconnect supervision), which guarantees that the central office does not return a dial tone after the called party hangs up. In most cases, the central office facility is a loop-start line/trunk which does not provide reliable disconnect. When loop-start lines/trunks are used, if the calling party stays on the line, the central office does return a dial tone at the conclusion of the call, enabling the caller to place another call as if it were being placed from your company. Ground-start trunks provide reliable disconnect and should be used whenever possible.

Preventive Measures

Take the following preventive measures to limit the risk of unauthorized use of the Automated Attendant feature by hackers:

- *Do not* use Automated Attendant prompts for Automatic Route Selection (ARS) codes or Pooled Facility codes.
- Assign all unused Automated Attendant selector codes to zero, so that attempts to dial these are routed to the system attendant.
- If Remote Call Forwarding (RCF) is required, MERLIN LEGEND Communications System owners should coordinate with their Lucent Technologies Account Team or authorized dealer to verify the type of central office facility used for RCF. If it is a ground-start line/trunk, or if it is a loop-start line/trunk and central office reliable disconnect can be ensured, then nothing else needs to be done.



NOTE:

In most cases, these are loop-start lines/trunks without reliable disconnect. The local telephone company must be involved in order to change the

facilities used for RCF to ground-start line/trunks. Usually, a charge applies for this change. Also, hardware and software changes may be necessary in the MERLIN LEGEND Communications System. The MERLIN Mail and MERLIN LEGEND Mail Automated Attendant feature merely accesses the RCF feature in the MERLIN LEGEND Communications System. Without these changes being made, this feature is highly susceptible to toll fraud. These same preventive measures must be taken if the RCF feature is active for MERLIN LEGEND Communications System extensions, whether or not it is accessed by an Automated Attendant menu.

Security Risks Associated with the Remote Access Feature

Remote Access allows the MERLIN LEGEND Communications System owner to access the system from a remote telephone and make an outgoing call or perform system administration using the network facilities (lines/trunks) connected to the MERLIN LEGEND Communications System. Hackers, scanning the public switched network by randomly dialing numbers with war dialers (a device that randomly dials telephone numbers, including 800 numbers, until a modem or dial tone is obtained), can find this feature, which will return a dial tone to them. They can even employ war dialers to attempt to discover barrier codes.

Preventive Measures

Take the following preventive measures to limit the risk of unauthorized use of the MERLIN LEGEND Communications System Remote Access feature:

- The Remote Access feature can be abused by criminal toll fraud hackers if it is not properly administered. Therefore, this feature should not be used unless there is a strong business need.
- It is strongly recommended that customers invest in security adjuncts, which typically use one-time passcode algorithms. These security adjuncts discourage hackers. Since a secure use of the Remote Access feature generally offers savings over credit-card calling, the break-even period can make the investment in security adjuncts worthwhile.
- If a customer chooses to use the Remote Access feature without a security adjunct, then multiple barrier codes should be employed, with one per user, if the system permits. The MERLIN LEGEND Communications System permits a maximum of 16 barrier codes.
- The maximum length should be used for each barrier code, and should be changed periodically. Barrier codes, like passwords, should consist of a random, hard-to-guess sequence of digits. While MERLIN LEGEND Communications System Release 3.0 permits a barrier code of up to 11 digits, systems prior to Release 3.0 permit barrier codes of up to only four digits.

If Remote Access is used, an upgrade to MERLIN LEGEND Communications System Release 3.0 is encouraged to take advantage of the longer barrier code.

Other Security Hints

Make sure that the Automated Attendant selector codes do not permit outside line selection.

Multiple layers of security are always recommended to keep your system secure.

A number of measures and guidelines that can help you ensure the security of your communications system and voice messaging system follows:

Educating Users

Everyone in your company who uses the telephone system is responsible for system security. Users and attendants/operators need to be aware of how to recognize and react to potential hacker activity. Informed people are more likely to cooperate with security measures that often make the system less flexible and more difficult to use.

- Never program passwords or authorization codes onto Auto Dial buttons. Display telephones reveal the programmed numbers and internal abusers can use the Auto Dial buttons to originate unauthorized calls.
- Discourage the practice of writing down barrier codes or passwords. If a barrier code or password needs to be written down, keep it in a secure place and never discard it while it is active.
- Instruct operators and attendants to inform tell their system manager whenever they answer a series of calls where there is silence on the other end or the caller hangs up.
- Advise users who are assigned voice mailboxes to frequently change personal passwords and not to choose obvious passwords.
- Ensure that the system manager advises users with special telephone privileges (such as Remote Access, Outcalling, and Remote Call Forwarding) of the potential risks and responsibilities.
- Be suspicious of any caller who claims to be with the telephone company and wants to check an outside line. Ask for a callback number, hang up, and confirm the caller's identity.
- Never distribute the office telephone directory to anyone outside the company; be careful when discarding it (shred the directory).
- Never accept collect telephone calls.

- Never discuss your telephone system's numbering plan with anyone outside the company.

Educating Operators

Operators or attendants need to be especially aware of how to recognize and react to potential hacker activity. To defend against toll fraud, operators should follow the guidelines below:

- Establish procedures to counter *social engineering*. Social engineering is a con game that hackers frequently use to obtain information that may help them gain access to your communications system or voice messaging system.
- When callers ask for assistance in placing outside or long-distance calls, ask for a callback extension.
- Verify the source. Ask callers claiming to be maintenance or service personnel for a callback number. Never transfer to *10 without this verification. Never transfer to extension 900.
- Remove the headset and/or handset when the console is not in use.

Detecting Toll Fraud

To detect toll fraud, users and operators should look for the following:

- Lost voice mail messages, mailbox lockout, or altered greetings
- Inability to log into voice mail
- Inability to get an outside line
- Foreign language callers
- Frequent hang-ups
- Touch-tone sounds
- Caller or employee complaints that the lines are busy
- Increases in internal requests for assistance in making outbound calls (particularly international calls or requests for dial tone)
- Outsiders trying to obtain sensitive information
- Callers claiming to be the "telephone" company
- Sudden increase in wrong numbers

Establishing a Policy

As a safeguard against toll fraud, follow these guidelines for your MERLIN LEGEND Communications System and voice messaging system:

- Change passwords frequently (at least quarterly). Changing passwords routinely on a specific date (such as the first of the month) helps users to remember to do so.
- Always use the longest-length password allowed.
- Establish well-controlled procedures for resetting passwords.
- Limit the number of invalid attempts to access a voice mailbox to five or less.
- Monitor access to the MERLIN LEGEND Communications System dial-up maintenance port. Change the access password regularly and issue it only to authorized personnel. Disconnect the maintenance port when not in use. (This however, eliminates Lucent Technologies' 24-hour maintenance surveillance capability and may result in additional maintenance costs.)
- Create a communications system management policy concerning employee turnover and include these suggestions:
 - Delete all unused voice mailboxes in the voice mail system.
 - If a terminated employee had Remote Access calling privileges and a personal authorization code, remove the authorization code immediately.
 - If barrier codes and/or authorization codes were shared by the terminated employee, these should be changed immediately.
- Regularly back up your MERLIN LEGEND Communications System files to ensure a timely recovery should it be required. Schedule regular, off-site backups.
- Keep the Remote Maintenance Device turned off when not in use by Lucent Technologies or your authorized dealer.
- Limit transfers to registered subscribers only.
- Use the Security Violations Notification options (Mailbox Lock or Warning Message) to alert you of any mailbox break-in attempts. Investigate all incidents.
- Review security policies and procedures and keep them up to date.

Choosing Passwords

Passwords should be the maximum length allowed by the system. Passwords should be hard to guess and should not contain:

- All the same numbers (for example, 1111, 666666).
- Sequential characters (for example, 123456).
- Numbers that can be associated with you or your business, such as your name, birthday, business name, business address, telephone number, or social security number.
- Words and commonly used names.

Passwords should be changed regularly—at least on a quarterly basis. Recycling old passwords is not recommended. Never program passwords (or authorization codes or barrier codes) onto a speed dial button.

Physical Security

You should always limit access to the system console (or attendant console) and supporting documentation. The following are some recommendations:

- Keep the system console and supporting documentation in an office that is secured with a changeable combination lock. Provide the combination only to those individuals having a real need to enter the office.
- Keep telephone wiring closets and equipment rooms locked.
- Keep telephone logs and printed reports in locations that only authorized personnel can enter.
- Design distributed reports so they do not reveal password or trunk access code information.
- Keep the voice messaging system Remote Maintenance Device turned off.

Limiting Outcalling

When Outcalling is used to contact subscribers who are off-site, use the MERLIN LEGEND Communications System Allowed Lists and Disallowed Lists or Automatic Route Selection features to minimize toll fraud.

If the Outcalling feature will not be used, outward restrict all voice messaging system ports. If Outcalling will be used, ports not used for Outcalling should be Outward Restricted (for MERLIN Mail Voice Messaging Systems, port 2 on a 2-port system, port 4 on a 4-port system, ports 5 and 6 on a 6-port system; for MERLIN LEGEND Mail Voice Messaging Systems, port 7 of the system's

module). Use Outward Restriction, Toll Restrictions, Allowed Lists, Disallowed Lists and Facility Restrictions Levels, as appropriate, to minimize the possibility of toll fraud.

Limited Warranty and Limitation of Liability

Lucent Technologies warrants to you, the customer, that your MERLIN LEGEND Communications System will be in good working order on the date Lucent Technologies or its authorized reseller delivers or installs the system, whichever is later ("Warranty Date"). If you notify Lucent Technologies or its authorized reseller within one year of the Warranty Date that your system is not in good working order, Lucent Technologies will, without charge to you, repair or replace, at its option, the system components that are not in good working order. Repair or replacement parts may be new or refurbished and will be provided on an exchange basis. If Lucent Technologies determines that your system cannot be repaired or replaced, Lucent Technologies will remove the system and, at your option, refund the purchase price of your system or apply the purchase price towards the purchase of another Lucent Technologies system.

If you purchased your system directly from Lucent Technologies, Lucent Technologies will perform warranty repair in accordance with the terms and conditions of the specific type of Lucent Technologies maintenance coverage you selected. If you purchased your system from a Lucent Technologies-authorized reseller, contact your reseller for the details of the maintenance plan applicable to your system.

This Lucent Technologies limited warranty covers damage to the system caused by power surges, including power surges due to lightning.

The following will not be deemed to impair the good working order of the system, and Lucent Technologies will not be responsible under the limited warranty for damages resulting from:

- Failure to follow Lucent Technologies' installation, operation, or maintenance instructions.
- Unauthorized system modification, movement, or alteration.
- Unauthorized use of common carrier communications services accessed through the system.
- Abuse, misuse, or negligent acts or omissions of the customer and persons under the customer's control.
- Acts of third parties and acts of God.

LUCENT TECHNOLOGIES' OBLIGATION TO REPAIR, REPLACE, OR REFUND AS SET FORTH ABOVE IS YOUR EXCLUSIVE REMEDY.

EXCEPT AS SPECIFICALLY SET FORTH ABOVE, LUCENT TECHNOLOGIES, ITS AFFILIATES, SUPPLIERS, AND AUTHORIZED RESELLERS MAKE NO WARRANTIES, EXPRESS OR IMPLIED, AND SPECIFICALLY DISCLAIM ANY WARRANTIES OF MERCHANTABILITY OR FITNESS FOR A PARTICULAR PURPOSE.

Limitation of Liability

Except as provided below, the liability of Lucent Technologies and its affiliates and suppliers for any claims, losses, damages, or expenses from any cause whatsoever (including acts or omissions of third parties), regardless of the form of action, whether in contract, tort, or otherwise, shall not exceed the lesser of: (1) the direct damages proven; or (2) the repair cost, replacement cost, license fee, annual rental charge, or purchase price, as the case may be, of the equipment that gives rise to the claim. Except as provided below, Lucent Technologies and its affiliates and suppliers shall not be liable for any incidental, special, reliance, consequential, or indirect loss or damage incurred in connection with the equipment. As used in this paragraph, consequential damages include, but are not limited to, the following: lost profits, lost revenues, and losses arising out of unauthorized use (or charges for such use) of common carrier telecommunications services or facilities accessed through or connected to the equipment. For personal injury caused by Lucent Technologies's negligence, Lucent Technologies's liability shall be limited to proven damages to person. **No action or proceeding against Lucent Technologies or its affiliates or suppliers may be commenced more than twenty-four (24) months after the cause of action accrues.** THIS PARAGRAPH SHALL SURVIVE FAILURE OF AN EXCLUSIVE REMEDY.

Remote Administration and Maintenance

The Remote Administration and Maintenance feature of your telecommunications system, if you choose to use it, permits users to change the system features and capabilities from a remote location.

The Remote Administration and Maintenance feature, through proper administration, can help you reduce the risk of unauthorized persons gaining access to the network. However, telephone numbers and access codes can be compromised when overheard in a public location, or lost through theft of a wallet or purse containing access information or through carelessness (for example, writing codes on a piece of paper and improperly discarding them). Additionally, hackers may use a computer to dial an access code and then publish the information to other hackers. Substantial charges can accumulate quickly. It is your responsibility to take appropriate steps to implement the features properly, evaluate and administer the various restriction levels, and protect and carefully distribute access codes.

Under applicable tariffs, you will be responsible for payment of toll charges. Lucent Technologies cannot be responsible for such charges and will not make any allowance or give any credit resulting from unauthorized access.

To reduce the risk of unauthorized access through Remote Administration and Maintenance, please observe the following procedures:

- The System Administration and Maintenance capability of a Hybrid/PBX or Key system is protected by a password.
 - Change the default password immediately.
 - Continue to change the password regularly.
 - Give the password only to people who need it and impress upon them the need to keep it secret.
 - If anyone who knows the password leaves the company, change the password immediately.
- If you have a special telephone line connected to your Hybrid/PBX or Key system for Remote Administration and Maintenance, you should do one of the following:
 - Unplug the line when it is not being used.
 - Install a switch in the line to turn it off when it is not being used.
 - Keep the Remote Administration and Maintenance telephone number secret. Give it only to people who need to know it, and impress upon them the need to keep it a secret. Do not write the telephone number on the Hybrid/PBX or Key system, the connecting equipment, or anywhere else in the system room.

If your Remote Administration and Maintenance feature requires that someone in your office transfer the caller to the Remote Administration and Maintenance extension, you should impress upon your employees the importance of transferring only authorized individuals to that extension.

Features and Planning Forms

B

This appendix contains an alphabetical list of the features that can be assigned to the system or system extensions and the planning forms associated with each feature.

Table B-1. Alphabetical List of Features

Feature	Planning Forms
Abbreviated Ring (see Ringing Options on page B-8)	
Account Code Entry/ Forced Account Code Entry	4d—MLX Telephone 4e—MFM Adjunct: MLX Telephone 4f—Tip/Ring Equipment 4h—ETR Telephone 4j—MLS Telephone 5a—Direct-Line Console (DLC): Analog 5b—Direct-Line Console (DLC): Digital 5c—MFM Adjunct: DLC 5d—Queued Call Console (QCC) Data Form 1a—Modem Data Station Data Form 1b—ISDN Terminal Adapter Data Station Data Form 3—Digital Data/Video Station
Alarm	2c—System Numbering: Line/Trunk Jacks 5a—Direct-Line Console (DLC): Analog 5b—Direct-Line Console (DLC): Digital
Allowed/Disallowed Lists	3a—Incoming Trunks: Remote Access 4b—Analog Multiline Telephone 4d—MLX Telephone 4e—MFM Adjunct: MLX Telephone 4f—Tip/Ring Equipment

Table B-1. Alphabetical List of Features — Continued

Feature	Planning Forms
	4h—ETR Telephone 4j—MLS Telephone 5a—Direct-Line Console (DLC): Analog 5b—Direct-Line Console (DLC): Digital 5c—MFM Adjunct: DLC 5d—Queued Call Console (QCC) 6e—Allowed Lists 6f—Disallowed Lists 6g—Call Restriction Assignments and Lists 9b—Night Service: Outward Restriction Data Form 1a—Modem Data Station Data Form 1b—ISDN Terminal Adapter Data Station Data Form 3—Digital Data/Video Station
Auto Answer All	Button diagrams on all appropriate telephone forms
Auto Answer Intercom	Button diagrams on all appropriate telephone forms
Auto Dial	Button diagrams on all appropriate telephone forms
Automatic Line Selection and Ringing/Idle Line Preference	4b—Analog Multiline Telephone 4d—MLX Telephone 4e—MFM Adjunct: MLX Telephone 4f—Tip/Ring Equipment 4h—ETR Telephone 4j—MLS Telephone 5a—Direct-Line Console (DLC): Analog 5b—Direct-Line Console (DLC): Digital 5c—MFM Adjunct: DLC
Automatic Maintenance Busy	1—System Planning
Automatic Route Selection (Facility Restriction Level)	3a—Incoming Trunks: Remote Access 3e—Automatic Route Selection Worksheet 3f—Automatic Route Selection Tables 3g—Automatic Route Selection Default and Special Numbers Tables 4b—Analog Multiline Telephone 4d—MLX Telephone 4e—MFM Adjunct: MLX Telephone 4f—Tip/Ring Equipment 4h—ETR Telephone 4j—MLS Telephone 5a—Direct-Line Console (DLC): Analog 5b—Direct-Line Console (DLC): Digital 5c—MFM Adjunct: DLC 6g—Call Restriction Assignments and Lists Data Form 1a—Modem Data Station Data Form 1b—ISDN Terminal Adapter Data Station Data Form 3—Digital Data/Video Station
Barge-In	Button diagrams on all appropriate telephone forms

Table B-1. Alphabetical List of Features — Continued

Feature	Planning Forms
Callback	3a—Incoming Trunks: Remote Access 4b—Analog Multiline Telephone 4d—MLX Telephone 4e—MFM Adjunct: MLX Telephone 4f—Tip/Ring Equipment 4h—ETR Telephone 4j—MLS Telephone 5a—Direct-Line Console (DLC): Analog 5b—Direct-Line Console (DLC): Digital 5c—MFM Adjunct: DLC 8a—System Features Data Form 1a—Modem Data Station Data Form 1b—ISDN Terminal Adapter Data Station Data Form 3—Digital Data/Video Station
Calling Restrictions	3a—Incoming Trunks: Remote Access 4b—Analog Multiline Telephone 4d—MLX Telephone 4e—MFM Adjunct: MLX Telephone 4f—Tip/Ring Equipment 4h—ETR Telephone 4j—MLS Telephone 5a—Direct-Line Console (DLC): Analog 5b—Direct-Line Console (DLC): Digital 5c—MFM Adjunct: DLC 5d—Queued Call Console (QCC) 6e—Allowed Lists 6f—Disallowed Lists 6g—Call Restriction Assignments and Lists 9b—Night Service: Outward Restriction Data Form 1a—Modem Data Station Data Form 1b—ISDN Terminal Adapter Data Station Data Form 3—Digital Data/Video Station
Call Waiting	Not Applicable
Camp-On	8a—System Features Button diagrams on all appropriate telephone forms
Centrex Operation	1—System Planning Button diagrams on all appropriate telephone forms
Conference	1—System Planning Button diagrams on all appropriate telephone forms

Table B-1. Alphabetical List of Features — Continued

Feature	Planning Forms
Coverage	4b—Analog Multiline Telephone 4d—MLX Telephone 4e—MFM Adjunct: MLX Telephone 4f—Tip/Ring Equipment 4h—ETR Telephone 4j—MLS Telephone 5a—Direct-Line Console (DLC): Analog 5b—Direct-Line Console (DLC): Digital 5c—MFM Adjunct: DLC 6a—Optional Operator Features 7c—Group Coverage 7d—Group Calling Button diagrams on all appropriate telephone forms
CTI Link	2a—System Numbering: Extension Jacks
Direct-Line Console	1—System Planning 5a—Direct-Line Console (DLC): Analog 5b—Direct-Line Console (DLC): Digital 5c—MFM Adjunct: DLC 6a—Optional Operator Features
Directories	2a—System Numbering: Extension Jacks 10b—System Speed Dial
Direct Station Selector-MLX	5a—Direct-Line Console (DLC): Analog 5b—Direct-Line Console (DLC): Digital 6a—Optional Operator Features
Display	Not Applicable
Do Not Disturb	Button diagrams on all appropriate telephone forms
Drop	1—System Planning Button diagrams on all appropriate telephone forms
Extension Status	5a—Direct-Line Console (DLC): Analog 5b—Direct-Line Console (DLC): Digital 8a—System Features
Forward and Follow Me (Remote Call Forward)	4b—Analog Multiline Telephone 4d—MLX Telephone 4e—MFM Adjunct: MLX Telephone 4f—Tip/Ring Equipment 4h—ETR Telephone 4j—MLS Telephone 5a—Direct-Line Console (DLC): Analog 5b—Direct-Line Console (DLC): Digital 5c—MFM Adjunct: DLC 6a—Optional Operator Features Button diagrams on all appropriate telephone forms

Table B-1. Alphabetical List of Features — Continued

Feature	Planning Forms
Group Calling	2d—System Numbering: Special Renumbers 6e—Group Calling 6f—System Features 7a—Night Service: Group Assignment Data Form 2—Data Hunt Groups
Headset Options	4b—Analog Multiline Telephone 4d—MLX Telephone 5a—Direct-Line Console (DLC): Analog 5b—Direct-Line Console (DLC): Digital 5d—Queued Call Console (QCC) Button diagrams on all appropriate telephone forms
Hold	2c—System Numbering: Line/Trunk Jacks 6a—Optional Operator Features 8a—System Features
Idle Line Preference (see Automatic Line Selection and Ringing/Idle Line Preference on page B-2)	
HotLine	4f—Tip/Ring Equipment
Inside Dial Tone	8a—System Features
Inspect	Not Applicable
Integrated Administration	1—System Planning 2c—System Numbering: Line/Trunk Jacks 2d—System Numbering: Special Renumbers 7d—Group Calling 8a—System Features 9a—Night Service: Group Assignment 9b—Night Service: Outward Restriction
Labeling	2a—System Numbering: Extension Jacks 2c—System Numbering: Line/Trunk Jacks 2d—System Numbering: Special Renumbers 10a—Label Form: Posted Message 10b—System Speed Dial
Language Choice	1—System Planning 4d—MLX Telephone 4h—ETR Telephone 5b—Direct-Line Console (DLC): Digital 5d—Queued Call Console (QCC)
Last Number Dial	Button diagrams on all appropriate telephone forms
Line Request	Not Applicable

Table B-1. Alphabetical List of Features — Continued

Feature	Planning Forms
Messaging (Message Waiting Receivers)	4b—Analog Multiline Telephone 4d—MLX Telephone 4e—MFM Adjunct: MLX Telephone 4f—Tip/Ring Equipment 4h—ETR Telephone 4j—MLS Telephone 5a—Direct-Line Console (DLC): Analog 5b—Direct-Line Console (DLC): Digital 5c—MFM Adjunct: DLC 5d—Queued Call Console (QCC) 6a—Optional Operator Features 7d—Group Calling 10a—Label Form: Posted Message
Microphone Disable	4d—MLX Telephone 5b—Direct-Line Console (DLC): Digital
Multi-Function Module	2a—System Numbering: Extension Jacks 2b—System Numbering: Digital Adjuncts 4d—MLX Telephone 4e—MFM Adjunct: MLX Telephone 5b—Direct-Line Console (DLC): Digital 5c—MFM Adjunct: DLC
Music-On-Hold	2c—System Numbering: Line/Trunk Jacks 8a—System Features
Night Service	9a—Night Service: Group Assignment 9b—Night Service: Outward Restriction 9c—Night Service: Time Set 9b—Night Service: Outward Restriction
Notify (see Signal/Notify on page B-8)	
Paging	2c—System Numbering: Line/Trunk Jacks 2d—System Numbering: Special Renumbers 4b—Analog Multiline Telephone 4d—MLX Telephone 4e—MFM Adjunct: MLX Telephone 4f—Tip/Ring Equipment 4h—ETR Telephone 4j—MLS Telephone 5a—Direct-Line Console (DLC): Analog 5b—Direct-Line Console (DLC): Digital 5c—MFM Adjunct: DLC 5d—Queued Call Console (QCC) 7b—Group Paging
Park	2d—System Numbering: Special Renumbers 6a—Optional Operator Features 8a—System Features Button diagrams on all appropriate telephone forms

Table B-1. Alphabetical List of Features — Continued

Feature	Planning Forms
Personal Lines	4b—Analog Multiline Telephone 4d—MLX Telephone 4e—MFM Adjunct: MLX Telephone 4f—Tip/Ring Equipment 4h—ETR Telephone 4j—MLS Telephone 5a—Direct-Line Console (DLC): Analog 5b—Direct-Line Console (DLC): Digital 5c—MFM Adjunct: DLC
Pickup	4b—Analog Multiline Telephone 4d—MLX Telephone 4e—MFM Adjunct: MLX Telephone 4f—Tip/Ring Equipment 4h—ETR Telephone 4j—MLS Telephone 5a—Direct-Line Console (DLC): Analog 5b—Direct-Line Console (DLC): Digital 5c—MFM Adjunct: DLC 5d—Queued Call Console (QCC) 7a—Call Pickup Groups
Pools	2c—System Numbering: Line/Trunk Jacks 2d—System Numbering: Special Renumbers 4b—Analog Multiline Telephone 4d—MLX Telephone 4e—MFM Adjunct: MLX Telephone 4f—Tip/Ring Equipment 4h—ETR Telephone 4j—MLS Telephone 5a—Direct-Line Console (DLC): Analog 5b—Direct-Line Console (DLC): Digital 5c—MFM Adjunct: DLC 5d—Queued Call Console (QCC) 3e—Automatic Route Selection Worksheet 3f—Automatic Route Selection Tables 3g—Automatic Route Selection Default and Special Numbers Tables Data Form 1a—Modem Data Station Data Form 1b—ISDN Terminal Adapter Data Station Data Form 3—Digital Data/Video Station
Power Failure Transfer	Not Applicable
Primary Rate Interface (PRI)	3b—Incoming Trunks: DS1 Connectivity (100D Module)
Privacy	Button diagrams on all appropriate telephone forms
Programming	1—System Planning

Table B-1. Alphabetical List of Features — Continued

Feature	Planning Forms
Queued Call Console	1—System Planning 2d—System Numbering: Special Renumbers 5d—Queued Call Console (QCC) 6a—Optional Operator Features 7c—Group Coverage 7d—Group Calling 8a—System Features
Recall/Timed Flash	1—System Planning Button diagrams on all appropriate telephone forms
Reminder Service	8a—System Features Button diagrams on all appropriate telephone forms
Remote Access	2d—System Numbering: Special Renumbers 3a—Incoming Trunks: Remote Access
Ringing/Idle Line Preference (see Automatic Line Selection and Ringing/Idle Line Preference on page B-2)	
Ringing Options	4b—Analog Multiline Telephone 4d—MLX Telephone 4e—MFM Adjunct: MLX Telephone 4h—ETR Telephone 4j—MLS Telephone 5a—Direct-Line Console (DLC): Analog 5b—Direct-Line Console (DLC): Digital 5c—MFM Adjunct: DLC
Saved Number Dial	Button diagrams on all appropriate telephone forms
Signal/Notify	Button diagrams on all appropriate telephone forms
Speed Dial	10b—System Speed Dial
Station Message Detail Recording (SMDR)	8a—System Features
System Access/Intercom Buttons	Button diagrams on all appropriate telephone forms
System Renumbering	2a—System Numbering: Extension Jacks 2b—System Numbering: Digital Adjuncts 2c—System Numbering: Line/Trunk Jacks 2d—System Numbering: Special Renumbers 6a—Optional Operator Features 7b—Group Paging 7d—Group Calling
Tandem Switching	If you are programming your system as part of a private network, contact the network engineering group for assistance.
Toll Type	2c—System Numbering: Line/Trunk Jacks 3e—Automatic Route Selection Worksheet

Table B-1. Alphabetical List of Features — Continued

Feature	Planning Forms
Touch-Tone or Rotary Signaling	2c—System Numbering: Line/Trunk Jacks 3c—Incoming Trunks: Tie 3d—Incoming Trunks: DID 8a—System Features
Transfer	1—System Planning 6a—Optional Operator Features 8a—System Features Button diagrams on all appropriate telephone forms
Uniform Dial Plan (UDP) Routing	Refer to Non-Local UDP Administration Form in the Installation Specification
Voice Announce	4b—Analog Multiline Telephone 4d—MLX Telephone 5a—Direct-Line Console (DLC): Analog 5b—Direct-Line Console (DLC): Digital Data Form 1a—Modem Data Station Data Form 1b—ISDN Terminal Adapter Data Station Data Form 3—Digital Data/Video Station Data Form 2—Data Hunt Group 5d—Queued Call Console (QCC)

C

System Features

This appendix provides an alphabetical list of systemwide features and outlines their availability by mode. Notes, where appropriate, briefly describe mode differences and specific release availability. For information about feature use on MLX, ETR, MLS, analog multiline, and single-line telephones, see [Appendix D, "General Feature Use and Telephone Programming."](#)

Table C-1. Availability by Mode

Feature	Key	Hybrid/ PBX	Behind Switch	Notes
Account Code Entry	✓	✓	✓	
Alarm	✓	✓	✓	Not for ETR or MLS telephones
Allowed/Disallowed Lists	✓	✓	✓	
Authorization Code	✓	✓	✓	Release 3.0 and later
Auto Answer All	✓	✓	✓	Analog multiline telephones
Auto Answer Intercom	✓	✓	✓	Analog multiline telephones
Auto Dial	✓	✓	✓	
Automatic Line Selection	✓	✓	✓	
Automatic Maintenance Busy	✓	✓	✓	
Automatic Route Selection		✓		For trunk pools only
Barge-In	✓	✓	✓	

Table C-1. Availability by Mode — Continued

Feature	Key	Hybrid/ PBX	Behind Switch	Notes
Basic Rate Interface	✓	✓	✓	Release 4.0 and later
Call-by-Call Service Selection		✓		Release 2.0 and later
Call Waiting	✓	✓	✓	
Callback	✓	✓	✓	Key and Behind Switch: not available for outside lines
Caller ID	✓	✓	✓	Release 3.0 and later. Requires 800 GS/LS-ID, 408 GS/LS-ID-MLX, or 412 LS-ID-ETR module and subscriber service from central office. The Caller ID feature is supported on the 408 GS/LS-ID-MLX module in Release 7.0 and later systems. The 412 LS-ID-ETR module is supported in Release 7.0 and later systems.
Calling Restrictions	✓	✓	✓	Hybrid/PBX: can deny access to trunk pools
Camp-On	✓	✓	✓	
Centralized Voice Messaging		✓		Release 6.1 and later
Centrex Transfer via Remote Call Forwarding	✓	✓	✓	Release 6.0 and later
Conference	✓	✓	✓	
Coverage	✓	✓	✓	
Coverage across a private network		✓		Release 6.1 and later; requires a calling group with a single non-local member
Coverage VMS	✓	✓		Release 2.0 and later
CTI Link		✓		Release 5.0 and later
Delay Ring interval	✓	✓	✓	
Digital Data Calls	✓	✓		Release 4.0 and later
Direct-Line Console (DLC) Options	✓	✓	✓	Hybrid/PBX: cannot have trunk pool access buttons

Table C-1. Availability by Mode — Continued

Feature	Key	Hybrid/ PBX	Behind Switch	Notes
Direct Voice Mail	✓	✓		
Directories	✓	✓	✓	MLX only
Direct Inward Dial (DID) Options		✓		
Direct Voice Mail	✓	✓		Release 3.0 and later
DS1 Module Options	✓	✓	✓	
Extension Status	✓	✓	✓	
Fax Extension	✓	✓	✓	
Forced Account Code Entry	✓	✓	✓	Behind Switch: unavailable for single-line telephones Hybrid/PBX and Behind Switch: users must enter account code before dial-out code
Group Call Coverage	✓	✓	✓	
Group Calling	✓	✓	✓	Behind Switch: calls do not follow the local telephone company's central office ring pattern
Headset Status	✓	✓	✓	MLX only
Hold Disconnect Interval	✓	✓	✓	
HotLine	✓	✓	✓	
Inside Dial Tone	✓	✓	✓	
Labeling	✓	✓	✓	
Language Choice	✓	✓	✓	Release 1.1 and later; MLX and ETR
Line/Trunk Options	✓	✓	✓	
Loudspeaker Paging	✓	✓	✓	
Microphone Disable	✓	✓	✓	MLX only
Night Service	✓	✓	✓	

Table C-1. Availability by Mode — Continued

Feature	Key	Hybrid/ PBX	Behind Switch	Notes
Paging Groups	✓	✓	✓	
Park	✓	✓	✓	
Pickup Groups	✓	✓	✓	
Pools (trunk group)		✓		
Primary Rate Interface (PRI) Options	✓	✓	✓	Release 2.0 and later
Queued Call Console (QCC)		✓		
Recall Interval (Recall/Timed Flash)	✓	✓	✓	Behind Switch: recall interval may need to be shortened
Reminder Service Cancel	✓	✓	✓	
Remote Access	✓	✓	✓	
Remote Call Forward	✓	✓	✓	Behind Switch: unavailable for single-line telephones
Ringing/Idle Line Preference	✓	✓	✓	
Routing by Dial Plan		✓		Release 2.0 and later
Second Dial Tone Timer	✓	✓	✓	Release 3.1 and later
Service Observing	✓	✓	✓	Release 6.1 and later
Station Message Detail Recording (SMDR)	✓	✓	✓	
System Numbering	✓	✓	✓	Hybrid/PBX: extension number is assigned to Listed Directory Number (the published main number) for QCC
System Restart	✓	✓	✓	
System Speed Dial	✓	✓	✓	
Tandem Switching		✓		Release 6.0 and later
Tandem PRI, T1 Tie, and Analog Tie trunks		✓		Release 6.0 and later

Table C-1. Availability by Mode — Continued

Feature	Key	Hybrid/ PBX	Behind Switch	Notes
T1 trunks	✓	✓		Switched 56 data supported in Release 4.0 and later
Tie Trunk Options	✓	✓	✓	
Timed Flash (Recall/Timed Flash)	✓	✓	✓	Release 2.0 and later
Toll Type	✓	✓	✓	
Touch-Tone or Rotary Signaling	✓	✓	✓	
Transfer Options	✓	✓	✓	
Uniform Dial Plan (UDP) Features		✓		Release 6.0 and later
Voice Announce	✓	✓	✓	Not for ETR and MLS telephones

General Feature Use and Telephone Programming

D

This appendix contains information on the general use of features for the MLX, ETR, MLS, analog multiline, and single-line telephones. It covers telephone and operator features and the acceptable programming codes for each. It also describes how to program these features on MLX, ETR, MLS, and analog multiline telephones.

General Feature Use Information

The following sections provide general instructions for feature use on MLX, ETR, MLS, analog multiline, and single-line telephones. Features can be used in the following ways:

- Press a dedicated feature button.
- Press a programmed button.

Fixed Features

All multiline telephones have a group of dedicated (or fixed) feature buttons that are programmed and labeled at the factory. The functions of these buttons, which include Conf, Transfer, and Speaker, cannot be changed. Press the button for the feature you want to use.

Programmed Buttons

Any unlabeled line button on multiline telephones can be programmed with a feature for one-touch activation. See [Table D-4](#) through [Table D-8](#) for additional information about programming features onto line buttons.

Some features, such as Auto Dial, must be programmed onto line buttons in order to function. Other features, such as Privacy, are best used if programmed onto line buttons—the LED next to the line button provides visual indication that the feature is in use. The following features must be programmed onto line buttons:

- Auto Answer All
- Auto Answer Headset
- Auto Dial
- Barge-In
- Coverage
 - Group Coverage
 - Primary Coverage
 - Secondary Coverage
 - Coverage Off
 - Coverage VMS Off
- Do Not Disturb
- Extension Status-Agent Login/Logout
- Feature Button (analog multiline telephones only)
- Headset/Handset Mute
- Headset Status
- Headset Hang Up
- Notify
- Posted Message (available from display on MLX display telephones)
- Saved Number Dial
- Service Observing
- Signal

Feature Codes

Feature codes are 1-, 2-, and 3-digit codes that activate features. A feature code is used by first pressing the dedicated Feature button on MLX telephones, pressing a programmed Feature button on analog multiline telephones, or dialing

on single-line telephones. Each of these methods sends a signal to the system that a feature code is about to be dialed. When the code is dialed, the feature is activated.



NOTE:

Queued Call Console (QCC) system operators cannot use feature codes.

The following features can be used only by dialing feature codes:

- Pickup
- Forward/Follow Me—Cancel One
- Forward/Follow Me—Cancel All
- Message Cancel
- Personal Speed Dial
- System Speed Dial



NOTE:

Pressing the Conf, Transfer, Speaker, or Feature button while activating a feature cancels the process. Pressing any other button, such as the Mute, HFAI, Message Status, DSS Page, More, Message, Clock, analog multiline display keys, or analog multiline disconnect button does not cancel the feature activating process.

Telephone and Operator Features

Tables [D-1](#), [D-2](#), and [D-3](#) list the telephone and operator features that can be assigned to telephones or consoles either through centralized telephone programming or by users from their telephones.

Table D-1. Telephone and Operator Features for MLX Telephones

Feature	Prog Code	Feature Code	2-Line Display	7-Line Display	MLX-5D/10D	MLX-28D	MLX-20L	MLX-5/10
Account Code Entry	*82	82 + code	Acct	AccountCode	K P B	K P B	K P B	K P
Alarm ¹	*759		Alarm	Alarm		K P B	K P B	
Alarm Clock			AlClk	Alarm Clock	K P B	K P B	K P B	
Authorization Code	*80	80	Auth	Auth Code	K P B	K P B	K P B	K P B
Auto Answer All	*754			AutoAns All				
Auto Answer Intercom	*753			AutoAnsIcom				
Auto Dial Inside (ext., group, zone) Outside	*22 + ext. no. *21 + tel. no.		AutoD In Out	Auto Dial Inside Outside	K P B	K P B	K P B	K P B
Automatic Line Selection Begin Sequence End Sequence	*14 **14				K P B	K P B	K P B	K P B
Barge-In ^{1,2}	*58		Barge	Barge In	K P B	K P B	K P B	K P B
Callback Automatic On Off Selective Cancel selective	*12 **12 *55	55 *55	CbckA On Off CbckS	Cback Auto On Off Cback Sel	K P B	K P B	K P B	K P B
Caller ID Number/Name Toggle Button	*763	763	Caller's number/name	Caller's number/ name	K P B	K P B	K P B	K P B
Camp-On	*57	57	Camp	Camp On	K P B	K P B	K P B	K P B

Table D-1. Telephone and Operator Features for MLX Telephones — Continued

Feature	Prog Code	Feature Code	2-Line Display	7-Line Display	MLX-5D/10D	MLX-28D	MLX-20L	MLX-5/10
Call Waiting On Off Call Waiting Pickup	*11 **11	87	CWait On Off	CallWaiting On Off	K P B	K P B	K P B	K P B
Conference	*772	772	Conf	Conference	B	B	B	B
Contrast			Ctrst		K P B	K P B	K P B	
Coverage Cover inside and outside calls Cover outside calls only Receiver buttons Group Primary Secondary Sender buttons Coverage Off Coverage VMS Off	*48 **48 *42 + ext. no. *40 + ext. no. *41 + ext. no. *49 *46		Cover CvIns, On CvIns, Off Group Prmry Secnd Cvoff	Coverage CoverInside, On CoverInside, Off Group Primary Secondary CoverageOff	K P B K P B K P B K P B K P B K P B	K P B K P B K P B K P B K P B K P B	K P B K P B K P B K P B K P B K P B	K P B K P B K P B K P B K P B K P B
Data Status	*83 + ext. no.				K P B	K P B	K P B	K P B
Direct Voice Mail	*56	56	DrcVM	Direct VM	K P	K P	K P	K P
Directories Extension Directory Personal Directory System Directory	(display only) (display only) (sys. prog.)		Dir ExtDir SysDir	Directory Ext Dir Personal Dir System Dir	K P B K P B	K P B K P B	K P B K P B K P B	
Do Not Disturb	*47		DND	DoNotDistrb	K P B	K P B	K P B	K P B
Drop	*773	773	Drop	Drop	B	B	B	B

Table D-1. Telephone and Operator Features for MLX Telephones — Continued

Feature	Prog Code	Feature Code	2-Line Display	7-Line Display	MLX-5D/10D	MLX-28D	MLX-20L	MLX-5/10
Extension Status								
Direct-Line Console ¹								
Status Off	*760	760 + DSS button	OPES, ESOff	OperatorES, ESOff		KPB	KPB	
Status 1	*761	761 + DSS button	OPES, ES1	OperatorES, ES1				
Status 2	*762	762 + DSS button	OPES, ES2	OperatorES, ES2	KPB	KPB	KPB	KPB
Telephones (room or agents)								
Status Off		*44						
Status 1	*45	45	ES, ES1	ES Status, ES1				
Status 2	*44	44	ES, ES2	ES Status, ES2				
Feature Button	*20			Feature Btn				

Table D-1. Telephone and Operator Features for MLX Telephones — Continued

Feature	Prog Code	Feature Code	2-Line Display	7-Line Display	MLX-5D/10D	MLX-28D	MLX-20L	MLX-5/10
Forward and Follow Me Activate					K P B	K P B	K P B	K P B
Forward (inside)	*33	33 + ext. no.	Forwd	Forward				
Remote Call Forward (outside)	*33	33 + tel no.	Forwd	Forward				
Centrex Transfer via Remote Call Forward	*33 + dial-out code or * + optional Pauses + tel. no. + #							
Follow Me Cancel		34 + ext. no.	FlwMe	Follow Me				
Cancel sending from your telephone		33 + your ext. no.		CancelFollow (QCC only)				
Cancel sending from one extension		*34 + ext. no.		CancelFollow (QCC only)				
Cancel sending from all extensions		*34*						

Table D-1. Telephone and Operator Features for MLX Telephones — Continued

Feature	Prog Code	Feature Code	2-Line Display	7-Line Display	MLX-5D/10D	MLX-28D	MLX-20L	MLX-5/10
Group Calling In-Queue Alarm button	*22 + calling group ext. no.		GrpCl	Group Call	K P B	K P B	K P B	K P B
Calling group supervisor ¹						K P B	K P B	
Enter supervisor mode ¹		32 + Hold						
Exit supervisor mode ¹		32 + Drop						
Available (ES Status 2)	*762	762 + DSS bt.	OPES, ES2	OperatorES, ES2				
Unavailable (ES Status Off)	*760	760 + DSS bt.	OPES, ESOff	OperatorES, ES Off	K P B	K P B	K P B	K P B
Calling group members								
Sign in (Available)	*44	44	ES	Status, ES2				
Sign out (Unavailable)		*44	ES,Off	ES Status, ES Off				
After-call work state (CMS only)	*45	45	ES, ES1	ES Status, ES1				
Group Page Auto Dial Button	*22 + paging group ext. no.		GrpPg	Group Page	K P B	K P B	K P B	K P B
Headset Options								
Auto Answer	*780		Hdset Auto	Hdset Auto Answer	K P B	K P B	K P B	K P B
Hang Up ²	*781			Hang Up				
Mute (Headset/Handset)	*783		Mute	Mute				
Status	*782		Stat	Status				
Hold		771			B	B	B	B
Hold release		**			B	B	B	B

Table D-1. Telephone and Operator Features for MLX Telephones — Continued

Feature	Prog Code	Feature Code	2-Line Display	7-Line Display	MLX-5D/10D	MLX-28D	MLX-20L	MLX-5/10
Intercom buttons					K B	K B	K B	K B
Assign buttons ²								
ICOM (Default Ring)	*16			SysAccess				
ICOM Originate Only								
Change button type	*18			SysAcc-00				
Ring								
Voice	**19		Voice, Place, Ring	Voice Annce, Place,Ring				
	*19		Voice, Place, Voice	Voice Annce, Place,Voice				
Language Choice					K P B	K P B	K P B	K P B
English		790						
French		791						
Spanish		792						
Last Number Dial	*84	84	Last#*	LastNumDial	K P B	K P B	K P B	K P B
Messaging								
Leave Message	*25		Msgs	Messages	K P B	K P B	K P B	K P B
After calling		25						
Without calling		53 + ext no.	LvMsg	Msg Leave				
Cancel msg. left		*53 + ext						
Message LED off	*54	no.						
Posted Message	*751	54	Post	Posted Msg	K P B	K P B	K P B	K P B
Send/Remove Msg ¹	*38		SdMsg	Send/RmvMsg	K P B	K P B	K P B	K P B
Receiving messages		38 + ext no.	Msgs	Messages		K P B	K P B	
Delete Message ³	*26		Dlete	Delete Msg	K P B	K P B	K P B	
Next Message ³	*28	26	Next	Next Msg	K P B	K P B	K P B	
Return Call ³	*27	28	Call	Return Call	K P B	K P B	K P B	
Scroll ³	*29	27						
		29						

Table D-1. Telephone and Operator Features for MLX Telephones — Continued

Feature	Prog Code	Feature Code	2-Line Display	7-Line Display	MLX-5D/10D	MLX-28D	MLX-20L	MLX-5/10
Night Service ¹	*39	39	Night	Night Srvc		K P B	K P B	
Notify Send Receive	*757 + ext. no. *758 + ext. no.		Ntfy Send Recv	Notify Send Receive	K P B	K P B	K P B	K P B
Paging Group Paging Loudspeaker Paging			GrpPg LdsPg	Group Page Loudspkr Pg	K P B	K P B	K P B	K P B
Park	*86		Park	Park	K P B	K P B	K P B	K P B
Park Zone Auto Dial ¹	*22 + park zone		PrkZn	Park Zone		K P B	K P B	
Personal Speed Dial	# + (01–24) + *21 + tel no. + ##		PSpdDl	PersSpeedDl	K P B			K P B
Personalized Ringing	*32 + ring (1–8)		PRing, Pat #1 ...Pat*8	PersonalRng, Pattern #1 ... Pattern #8	K P B	K P B	K P B	K P B
Pickup General use Specific extension Specific line Group	*9 *9 + ext. no. *9 + line no. *88	9 + ext. no. 9 + line no. 88	Pkup Genrl Ext Line PkupG	Pickup General Extension Line PickupGroup	K P B	K P B	K P B	K P B
Privacy On Off	*31	31 *31	Prvcy	Privacy	K P B	K P B	K P B	K P B

Table D-1. Telephone and Operator Features for MLX Telephones — Continued

Feature	Prog Code	Feature Code	2-Line Display	7-Line Display	MLX-5D/10D	MLX-28D	MLX-20L	MLX-5/10
Recall	*775	775	Rec11	Recall	K P B	K P B	K P B	K P B
Reminder Service Set ⁴	*81	81 + time + A or P	Rmind Set	Reminder Set	K P B	K P B	K P B	K P B
Operator Set ^{1,4}		81 + ext. no. + time + A or P §						
Cancel Operator Cancel ¹	**81	*81	Cancel	Cancel				
Missed ¹	*752	*81 + ext. no.	Missd	Missed				
Ringin/Idle Line Preference					K P B	K P B	K P B	K P B
On	*343		LnPrf, On	Line Preference, On				
Off	*344		LnPrf, Off	Line Preference, Off				

Table D-1. Telephone and Operator Features for MLX Telephones — Continued

Feature	Prog Code	Feature Code	2-Line Display	7-Line Display	MLX-5D/10D	MLX-28D	MLX-20L	MLX-5/10
Ringing Options			RngOp	RingOptions				
Individual lines			1Line	One Line	K P B	K P B	K P B	K P B
Immediate ring	*37		Immed	Immed Ring				
Delay ring	*36		Delay	Delay Ring				
No ring	*35		No	No Ring				
All lines			AllLn	All Lines	K P B	K P B	K P B	K P B
Immediate ring	*347		Immed	Immed Ring				
Delay ring	*346		Delay	Delay Ring				
No ring	*345		No	No Ring				
Abbreviated ring			Abbrv	Abbreviated	K P B	K P B	K P B	K P B
On	*341		On	On				
Off	*342		Off	Off				
Send Ring (Shared SA)			ShRng	SharedSARng	P	P	P	P
On	*15		On	On				
Off	**15		Off	Off				
Saved Number Dial	*85		Save#	SaveNumDial	K P B	K P B	K P B	K P B
Send/Remove Message ¹	*38	38 + ext. no.	SdMsg	Send/RmvMsg		K P B	K P B	
Service Observing ²	*59		Service Observing	Service Observing	K P B	K P B	K P B	K P B
Signal (manual)	*23 + ext. no.		Signl	Signal	K P B	K P B	K P B	K P B

Table D-1. Telephone and Operator Features for MLX Telephones — Continued

Feature	Prog Code	Feature Code	2-Line Display	7-Line Display	MLX-5D/10D	MLX-28D	MLX-20L	MLX-5/10
System Access buttons Assign buttons ² SA (Default Ring) SA Originate Only Shared SA Change type (SA or Shared SA) Ring Voice	*16 *18 *17 + primary ext. no. **19 *19			SysAccess SysAcc-00 ShareSysAcc	P	P	P	P
System Speed Dial	*24 + code (600-729)	600-729	SpdD1	SysSpeedD1	K P B	K P B	K P B	K P B
Transfer	*774	774	Trans	Transfer	B	B	B	B
Voice Announce On Off VA on Idle Only	*10 **10 *131		Voice On Off Idle	Voice Annce On Off Idle	K P B	K P B	K P B	K P B

- 1 System operator feature only.
- 2 Centralized telephone programming only.
- 3 Display telephones only. Programming and feature codes are used with analog multiline, ETR, and MLS telephones.
- 4 English only: time is 12-hour (0100-1259) + 2 (A) or 7 (P). French and Spanish: time is 24-hour (0000-2359).

Table D-2. Telephone and Operator Features for Analog Multiline and Single-Line Telephones

Feature	Prog Code	Feature Code	2-Line Display	Analog Multiline	Single-Line
Account Code Entry	*82	82 + code	Acct	K P B	K P
Alarm ¹	*759		Alarm		
Alarm Clock			AlClk	K P B	
Authorization Code	*80	80	Auth	K P B	K P B
Auto Answer All	*754				
Auto Answer Intercom	*753				
Auto Dial Inside (ext., group, zone) Outside	*22 + ext. no. *21 + tel. no.		AutoD In Out	K P B	K P B
Automatic Line Selection Begin Sequence End Sequence	*14 **14			K P B	K P B
Barge-In ^{1,2}	*58		Barge	K P B	K P B
Callback Automatic On Off Selective Cancel selective	*12 **12 *55	55 *55	CbckA On Off CbckS	K P B	K P B
Caller ID Number/Name Toggle Button	*763	763	Caller's number/name	K P B	K P B
Camp-On	*57	57	Camp	K P B	K P B
Call Waiting On Off Call Waiting Pickup	*11 **11	87	CWait On Off	K P B	K P B
Conference	*772	772	Conf	B	B
Contrast			Ctrst	K P B	

Table D-2. Telephone and Operator Features for Analog Multiline and Single-Line Telephones — Continued

Feature	Prog Code	Feature Code	2-Line Display	Analog Multiline	Single-Line
Coverage			Cover	K P B	K P B
Cover inside and outside calls	*48		CvIns, On		
Cover outside calls only	**48		CvIns, Off		
Receiver buttons					
Group	*42 + ext. no.		Group	K P B	K P B
Primary	*40 + ext. no.		Prmry	K P B	K P B
Secondary	*41 + ext. no.		Secnd	K P B	K P B
Sender buttons					
Coverage Off	*49		Cvoff	K P B	K P B
Coverage VMS Off	*46			K P B	K P B
Data Status	*83 + ext. no.			K P B	K P B
Direct Voice Mail	*56	56	DrcVM	K P	K P
Directories			Dir		
Extension Directory	(display only)		ExtDir	K P B	
Personal Directory	(display only)				
System Directory	(sys. prog.)		SysDir	K P B	
Do Not Disturb	*47		DND	K P B	K P B
Drop	*773	773	Drop	B	B
Extension Status					
Direct-Line Console ¹					
Status Off	*760	760 + DSS button	OPES, ESOff		
Status 1	*761	761 + DSS button	OPES, ES1		
Status 2	*762	762 + DSS button	OPES, ES2		
Telephones (rooms or agents)				K P B	K P B
Status Off		*44			
Status 1	*45	45	ES, ES1		
Status 2	*44	44	ES, ES2		
Feature Button	*20				

Table D-2. Telephone and Operator Features for Analog Multiline and Single-Line Telephones — Continued

Feature	Prog Code	Feature Code	2-Line Display	Analog Multiline	Single-Line
Forward and Follow Me Activate				K P B	K P B
Forward (inside)	*33	33 + ext. no.	Forwd		
Remote Call Forward (outside)	*33	33 + tel no.	Forwd		
Centrex Transfer via Remote Call Forward	*33 + dial-out code or * + optional Pauses + tel. no. + #				
Follow Me Cancel			FlwMe		
Cancel sending from your telephone		34 + ext. no.			
Cancel sending from one extension		33 + your ext. no.			
Cancel sending from all extensions		*34 + ext. no. *34*			
Group Calling In-Queue Alarm button	*22 + calling group ext. no.		GrpCl	K P B	K P B
Calling group supervisor ¹					
Enter supervisor mode ¹		32 + Hold			
Exit supervisor mode ¹		32 + Drop			
Available (ES Status 2)	*762	762 + DSS bt.	OPES, ES2		
Unavailable (ES Status Off)	*760	760 + DSS bt.	OPES, ESOff		
Calling group members				K P B	K P B
Sign in (Available)	*44	44	ES		
Sign out (Unavailable)		*44	ES, Off		
After-call work state (CMS only)	*45	45	ES, ES1		
Group Page Auto Dial Button	*22 + paging group ext. no.		GrpPg	K P B	K P B
Hold		771		B	B
Hold release		**		B	B

Table D-2. Telephone and Operator Features for Analog Multiline and Single-Line Telephones — Continued

Feature	Prog Code	Feature Code	2-Line Display	Analog Multiline	Single-Line
Intercom buttons Assign buttons ² ICOM (Default Ring) ICOM Originate Only Change button type Ring Voice	*16 *18 **19 *19		Voice, Place, Ring Voice, Place, Voice	K B	K B
Language Choice English French Spanish		790 791 792		K P B	K P B
Last Number Dial	*84	84	Last#*	K P B	K P B
Messaging Leave Message After calling Without calling Cancel msg. left Message LED off (for non-display telephones) Message operation mode (for display telephones) ³ Posted Message Send/Remove Msg ¹	*25 *54 *54 *751 *38	25 53 + ext no. *53 + ext no. 54 54 38 + ext no.	Msgs LvMsg Post SdMsg	K P B K P B	K P B K P B
Receiving messages Delete Message ⁴ Next Message ⁴ Return Call ⁴ Scroll ⁴	*26 *28 *27 *29	26 28 27 29	Msgs Dlete Next Call	K P B K P B K P B	
Night Service ¹	*39	39	Night		
Notify Send Receive	*757 + ext. no. *758 + ext. no.		Nt fy Send Recv	K P B	K P B
Paging Group Paging Loudspeaker Paging			GrpPg LdsPg	K P B	K P B
Park	*86		Park	K P B	K P B

Table D-2. Telephone and Operator Features for Analog Multiline and Single-Line Telephones — *Continued*

Feature	Prog Code	Feature Code	2-Line Display	Analog Multiline	Single-Line
Park Zone Auto Dial ¹	*22 + park zone		PrkZn		
Personal Speed Dial	# + (01-24) + *21 + tel no. + ##		PSpdDl	K P B	K P B
Personalized Ringing	*32 + ring (1-8)		PRing, Pat #1 ...Pat*8	K P B	K P B
Pickup General use Specific extension Specific line Group	*9 *9 + ext. no. *9 + line no. *88	9 + ext. no. 9 + line no. 88	Pkup Genrl Ext Line PkupG	K P B	K P B
Privacy On Off	*31	31 *31	Prvcy	K P B	K P B
Recall	*775	775	Recll	K P B	K P B
Reminder Service Set ⁵ Operator Set ^{1,5} Cancel Operator Cancel ¹ Missed ¹	*81 **81 *752	81 + time + A or P 81 + ext. no.+ time + A or P *81 *81 + ext. no.	Rmind Set Cancl Misssd	K P B	K P B
Ringing/Idle Line Preference On Off	*343 *344		LnPrf, On LnPrf, Off	K P B	K P B

Table D-2. Telephone and Operator Features for Analog Multiline and Single-Line Telephones — Continued

Feature	Prog Code	Feature Code	2-Line Display	Analog Multiline	Single-Line
Ringing Options Individual lines Immediate ring Delay ring No ring All lines Immediate ring Delay ring No ring Abbreviated ring On Off Send Ring (Shared SA) On Off	 *37 *36 *35 *347 *346 *345 *341 *342 *15 **15		RngOp lLine Immed Delay No AllLn Immed Delay No Abbrv On Off ShRng On Off	K P B K P B K P B P	K P B K P B K P B P
Saved Number Dial	*85		Save#	K P B	K P B
Send/Remove Message ¹	*38	38 + ext. no.	SdMsg		
Signal (manual)	*23 + ext. no.		Signl	K P B	K P B
System Access buttons Assign buttons ² SA (Default Ring) SA Originate Only Shared SA Change type (SA or Shared SA) Ring Voice	 *16 *18 *17 + primary ext. no. **19 *19			P	P

Table D-2. Telephone and Operator Features for Analog Multiline and Single-Line Telephones — Continued

Feature	Prog Code	Feature Code	2-Line Display	Analog Multiline	Single-Line
System Speed Dial	*24 + code (600-729)	600-729	SpdD1	K P B	K P B
Transfer	*774	774	Trans	B	B
Voice Announce to Busy On Off	*10 **10		Voice On Off	K P B	K P B

1 System operator feature only.

2 Centralized telephone programming only.

3 For analog multiline display telephone users, pressing *54 enters/exits Message operation mode. Analog multiline telephones return to normal call handling after 15 seconds if the user has no messages. If the user has messages, he or she must delete the messages or use the feature code or programmed button to exit Message operation.

4 Display telephones only. Programming and feature codes are used with analog multiline, ETR, and MLS telephones.

5 English only: time is 12-hour (0100-1259) + 2 (A) or 7 (P). French and Spanish: time is 24-hour (0000-2359).

Table D-3. Telephone and Operator Features for ETR and MLS Telephones

Feature	Prog Code	Feature Code	ETR Display	MLS Display	ETR	MLS
Account Code Entry	*82	82 + code	Acct:	Acct?	K P B	K P B
Authorization Code	*80	80	Auth:	Auth?	K P B	K P B
Auto Dial Inside (ext., group, zone) Outside	*22 + ext. no. *21 + tel. no.		Inside Outside	Auto Dial Inside Outside	K P B	K P B
Automatic Line Selection Begin Sequence End Sequence	*14 **14				K P B	K P B
Barge-In ¹	*58		Barge In		K P B	K P B
Callback Automatic On Off Selective	*12 **12 *55	55	Cbck Auto On Off Cbck Sel	AutoCallback On AutoCallback off Callback Sel	K P B	K P B
Caller ID Number/Name Toggle Button	*763	763	Caller's number/name	Caller's number/name	K P B	K P B
Camp-On	*57	57	Camp On	Camp On	K P B	K P B
Call Waiting On Off Call Waiting Pickup	*11 **11	87	CallWaiting On Off	Call Waiting On Call Waiting Off	K P B	K P B
Conference	*772	772			B	B
Contrast ²				N/A		

Table D-3. Telephone and Operator Features for ETR and MLS Telephones — Continued

Feature	Prog Code	Feature Code	ETR Display	MLS Display	ETR	MLS
Coverage			Coverage	Coverage	K P B	K P B
Cover inside and outside calls	*48		On	Cover Inside On		
Cover outside calls only	**48		Off	Cover Inside Off		
Receiver buttons						
Group	*42 + ext. no.		Group	GroupCov	K P B	K P B
Primary	*40 + ext. no.		Primary	PrmryCov	K P B	K P B
Secondary	*41 + ext. no.		Secondary	SecndCov	K P B	K P B
Sender buttons						
Coverage Off	*49		Coverage Off	Coverage Off	K P B	K P B
Coverage VMS Off	*46		Coverage VMS	Coverage VMS	K P B	K P B
Data Status	*83 + ext. no.		Data Status	Data Status	K P B	K P B
Direct Voice Mail	*56	56	Direct VM	Direct VoiceMail	K P B	K P B
Do Not Disturb	*47		DoNotDistrb	DO NOT DISTURB	K P B	K P B
Drop	*773	773			B	B

Table D-3. Telephone and Operator Features for ETR and MLS Telephones — Continued

Feature	Prog Code	Feature Code	ETR Display	MLS Display	ETR	MLS
Forward and Follow Me Activate					K P B	K P B
Forward (inside)	*33	33 + ext. no.	Forward	Forward		
Remote Call Forward (outside)	*33	33 + tel no.	Forward	Forward		
Centrex Transfer via Remote Call Forward	*33 + dial-out code or * + optional Pauses + tel. no. + #					
Follow Me		34 + ext. no.				
Cancel						
Cancel sending from your telephone		33 + your ext. no.				
Cancel sending from one extension		*34 + ext. no.				
Cancel sending from all extensions		*34*				
Group Calling						
In-Queue Alarm button	*22 + calling group ext. no.		Group Call	Group Call	K P B	K P B
Calling group members						
Sign in (Available)	*44	44	ES2	ES2	K P B	K P B
Sign out (Unavailable)		*44			K P B	K P B
After-call work state (CMS only)	*45	45	ES1	ES1	K P B	K P B
Group Page Auto Dial Button	*22 + paging group ext. no.		Group Page	Group Page	K P B	K P B
Hold		771			B	B
Hold release		**			B	B

Table D-3. Telephone and Operator Features for ETR and MLS Telephones — Continued

Feature	Prog Code	Feature Code	ETR Display	MLS Display	ETR	MLS
Intercom buttons					K P B	K P B
Assign buttons ²						
ICOM (Default Ring)	*16		SysAccess	SysAccess		
ICOM Originate Only	*18		SysAcc-00	SysAcc-00		
Change button type						
Ring	**19		Place; Ring	Place Ring Calls		
Voice	*19		Place; Voice	Place Voice Calls		
Language Choice					K P B	K P B
English		790				
French		791				
Spanish		792				
Last Number Dial	*84	84	LastNumDial	Last Number Dial	K P B	K P B
Messaging						
Leave Message	*25			Leave Message	K P B	K P B
After calling		25	Msg Leave	Msg Leave	K P B	K P B
Without calling		53 + ext no.			K P B	K P B
Cancel msg. left		*53 + ext no.			K P B	K P B
Message LED off (non- display telephones)	*54	54	Msg Lamp	Message Lamp	K P B	K P B
Message operation mode (display telephones) ³	*54	54			K P B	K P B
Posted Message	*751		Posted Msg	Posted Message	K P B	K P B
Receiving messages						
Delete Message ⁴	*26	26	Msg Delete	Delete Message	K P B	K P B
Next Message ⁴	*28	28	Msg Next	Next Message	K P B	K P B
Return Call ⁴	*27	27	Msg RtnCall	Message Return call	K P B	K P B
Scroll ⁴	*29	29	Msg Scroll	Scroll Message	K P B	K P B

Table D-3. Telephone and Operator Features for ETR and MLS Telephones — Continued

Feature	Prog Code	Feature Code	ETR Display	MLS Display	ETR	MLS
Notify Send Receive	*757 + ext. no. *758 + ext. no.		Notify Send Receive	Notify Send notify Recv	K P B	K P B
Paging Group Paging Loudspeaker Paging			Group Page		K P B	K P B
Park	*86		Park		K P B	K P B
Personal Speed Dial	# + (01-24) + *21 + tel no. + ##		PersSpeedDl	PersSpeedDial	K P B	K P B
Personalized Ringing	*32 + ring (1-8)		PersonalRng	Personal Ring	K P B	K P B
Pickup General use Specific extension Specific line Group	*9 *9 + ext. no. *9 + line no. *88	9 + ext. no. 9 + line no. 88	Pickup General Extension Line Group	Pickup Pickup General Pickup Ext. Pickup Line Pickup Group	K P B	K P B
Privacy On Off	*31	31 *31	Privacy	Privacy	K P B	K P B
Recall	*775	775	Recall	Recall	K P B	K P B
Reminder Service Set ⁵ Cancel	*81 **81	81 + time + A or P *81	Reminder Set Cancel	Reminder Reminder Set Reminder Cancel	K P B	K P B
Ringin/Idle Line Preference On Off	*343 *344		Line Prefer On Off	LinePreferenceOn LinePreferenceOff	K P B	K P B

Table D-3. Telephone and Operator Features for ETR and MLS Telephones — Continued

Feature	Prog Code	Feature Code	ETR Display	MLS Display	ETR	MLS
Ringing Options Individual lines ⁶ Immediate ring Delay ring No ring All lines Immediate ring Delay ring No ring Abbreviated ring On Off Send Ring (Shared SA) On Off	 *37 *36 *35 *347 *346 *345 *341 *342 *15 **15		RingOptions One Line Immed Ring Delay Ring No Ring All Lines Immed Ring Delay Ring No Ring Abbreviated On Off SharedSARng On Off	RingOptions Immed Ring Delay Ring No Ring All Lines - I All Lines - D All Lines - N AbbreviatedRngOn AbbreviatedRngOff SharedSA Rng On SharedSA Rng Off	K P B K P B K P B K P B K P B K P B K P B K P B K P B K P B K P B K P B P P P	K P B K P B K P B K P B K P B K P B K P B K P B K P B K P B K P B P P P
Saved Number Dial	*85		SaveNumDial	Save Number Dial	K P B	K P B
Signal (manual)	*23 + ext. no.		Signal	Signal	K P B	K P B
System Access buttons Assign buttons ² SA (Default Ring) SA Originate Only Shared SA Change type (SA or Shared SA) Ring Voice	 *16 *18 *17 + primary ext. no. **19 *19		SysAccess SysAcc-00 ShareSysAcc Place; Ring Place; Voice	SysAccess SysAcc-00 ShareSysAcc Place Ring Calls Place Voice Calls	P P P P K P B K P B	P P P P K P B K P B
System Speed Dial	*24 + code (600-729)	600-729	SysSpeedDl	SysSpeedDial	K P B	K P B
Transfer	*774	774	Trans		B	B

Table D-3. Telephone and Operator Features for ETR and MLS Telephones — Continued

Feature	Prog Code	Feature Code	ETR Display	MLS Display	ETR	MLS
Voice Announce On Off	*10 **10		Voice Annce Receive; On Receive; Off	Voice Annce RecvVoiceAnn On RecvVoiceAnn Off	K P B	K P B

- 1 Centralized telephone programming only.
- 2 Press the * button and use the volume up and down key; for ETR telephones only.
- 3 For MLS and ETR display telephone users, pressing *54 enters/exits Message operation mode. MLS telephones return to normal call handling after 15 seconds if the user has no messages. If an MLS telephone user has messages, he or she must delete the messages or use the feature code or programmed button to exit Message operation. An ETR telephone user must use the feature code or the programmed button to exit Message operation whether or not he or she has messages.
- 4 Display telephones only. Programming and feature codes are used with analog multiline, ETR, and MLS telephones.
- 5 English only: time is 12-hour (0100–1259) + 2 (A) or 7 (P). French and Spanish: time is 24-hour (0000–2359).
- 6 With Immediate Ring (steady red LED), incoming calls are immediately delivered. With Delay Ring (slow red LED), incoming calls are delayed (default is 2 rings). With No Ring (LED off), no calls are delivered.

Telephone Programming

The following describes how to program features on MLX, ETR, MLS, and analog multiline telephones. Because Personal Speed Dial is the only feature that single-line telephone users can program, general programming instructions for single-line telephones are not provided.



NOTE:

Features cannot be programmed on QCCs in system operator positions.

Features assigned to these consoles are fixed and cannot be changed.

Programming Methods

Telephones can be programmed by dialing programming codes or, on MLX display telephones, by selecting features from the display. Analog multiline, ETR, and MLS telephones cannot be programmed by selecting features from the display.

To program a telephone, first enter programming mode:

- On analog multiline telephones, slide the Test/Program (T/P) switch on the side of the telephone to P, or lift the handset, or press the Spkrphone button and dial #00.
- On ETR and MLS telephones, press the Feature button and dial 00.
- On MLX-10 and MLX-5 nondisplay telephones, press the Feature button and dial 00.
- On MLX display telephones, use the same procedures as for the MLX nondisplay telephones or enter programming mode by selecting **Ext Program** from the menu screen on the display.
- On TransTalk MDC 9000 and MDW 9000 telephones, press the imprinted **Feat** button and dial 00.
- On Business Cordles 905, press SHIFT + PROG.

See the appropriate user or operator guide for more information.



NOTE:

Features can also be programmed onto individual telephones through centralized telephone programming. The steps for using programming codes vary, depending on the telephone. Tables [D-4](#) through [D-8](#) list the basic steps for programming each telephone type.

Table D-4. Programming Analog Multiline Telephones



Step	Action
1 Label the button.  NOTE: Skip this step if the feature is not programmed on a button.	Remove the clear label cover from the telephone: insert the end of a paper clip in the notch at the top of the cover. Write the feature name on the card next to the button to be programmed. Replace the cover.
2 Begin programming.	Slide the T/P switch on the side of the telephone to P.
3 Select the feature or setting.	Press the button you labeled. <i>If you have a display telephone, it shows the name of the feature currently programmed on the button. If no feature is programmed, the display indicates that the button is blank.</i>  NOTE: If the feature does not get programmed onto a button, press any line button. This does not affect the button in any way. Dial the programming code. <i>The feature is programmed.</i>
4 End programming.	Slide the T/P switch to the center position.

Table D-5. Programming ETR and MLS Telephones



Step	Action
1 Label the button.  NOTE: Skip this step if the feature is not programmed on a button.	Remove the clear label cover from the telephone: pull up on the tab that extends from the top of the cover. Write the feature name on the card next to the button to be programmed. Replace the cover.
2 Begin programming.	Press the Feature button, and then dial 00.
3 Select the feature or setting.	Press the button you labeled.  NOTE: If the feature is programmed onto a button, press any line button. This does not affect the button in any way. Dial the programming code. <i>The feature is programmed.</i>
4 End programming.	Press the Feature button, and dial *00.

Table D-6. Programming MLX-10 and MLX-5 Nondisplay Telephones



Step	Action
1 Label the button.  NOTE: Skip this step if the feature is not programmed on a button.	Remove the clear label cover from the telephone: pull up on the tab that extends from the top of the cover. Write the feature name on the card next to the button to be programmed. Replace the cover.
2 Begin programming.	Press the Feature button, and then dial 00.
3 Select the feature or setting.	Press the button you labeled.  NOTE: If the feature is programmed onto a button, press any line button. This does not affect the button in any way. Dial the programming code. <i>The feature is programmed.</i>
4 End programming.	Press the Feature button, and dial *00.

Table D-7. Programming MLX Telephones by Using the Display



Step	Action
<p>1 Label the button to be programmed.</p> <p> NOTE: Skip this step if the feature will not be programmed onto a button.</p>	<p>Remove the clear label cover from the telephone by pulling up on the tab that extends from the top of the cover.</p> <p>Write the feature name on the card next to the button to be programmed.</p> <p>Replace the cover.</p>
<p>2 Begin programming.</p>	<p>Press Menu.</p> <p>Select <code>Ext Program</code> from the display.</p> <p>Select <code>Start</code> from the display.</p>
<p>3 Identify the button to be programmed.</p> <p>To delete the features currently programmed on the button:</p> <p>To display features:</p>	<p>Press the button you labeled.</p> <p> NOTE: Note: If the feature does not get programmed onto a button, press any line button. This does not affect the button in any way.</p> <p><i>The display identifies the feature currently programmed on the button. If no feature is programmed, the display indicates that the button is blank.</i></p> <p>Select <code>Delete</code> from the display.</p> <p><i>The button is now blank.</i></p> <p>Press the button you labeled again to continue programming.</p> <p> NOTE: If the currently programmed feature was not deleted from the button, the new feature programmed onto it will replace it.</p> <p>Select <code>List Feature</code> from the display.</p> <p>The screen lists feature names in alphabetical order.</p>

Table D-7. Programming MLX Telephones by Using the Display — Continued



Step	Action
<p>4 Select the feature.</p> <p>If the feature name is on the display:</p> <p>If the feature name is not on the display:</p> <p>To move through the list of features page by page:</p> <p>To jump to the screen that displays the feature name:</p>	<p>Press the button next to or below the name of the feature to be programmed.</p> <p>Press More.</p> <p>Press More.</p> <p>Select Find Feature from the display.</p> <p>Select the range of letters from the display that corresponds to the first letter of the feature name (for example, if the feature begins with A, select ABC).</p> <p>If the feature is not displayed on the page that you jumped to, press More.</p> <p>When you find the feature you want, press the button next to or below it.</p>
<p>5 Respond to any additional prompts on the display.</p>	<p>Select the appropriate prompt (for example, select On or Off to turn inside Coverage on or off), and/or enter required information (for example, dial a telephone number for Auto Dial).</p> <p>Select Enter.</p>
<p>6 End programming.</p> <p>To return to the Home screen:</p> <p>To return to the Menu screen:</p>	<p>Press Home or lift and replace the handset.</p> <p>Press Menu.</p>



NOTE:

MLX display telephones can also be programmed using the method described for MLX-10 and MLX-5 nondisplay telephones. For example, the programming mode can be entered by pressing the Feature button, dialing 00, and then referring to the display to continue the programming process. Or you can enter programming by using the display and then dialing a programming code to select the feature rather than selecting it from the display.

Table D-8. Programming TransTalk MDC 9000 and MDW Telephones

Step	Action
1 Label the button to be programmed.	Remove the clear label cover from the telephone by pulling up on the tab that extends from the top of the cover.
 NOTE: Skip this step if the feature will not be programmed onto a button.	Write the feature name on the card next to the button to be programmed. Replace the cover.
2 Begin programming.	Press the imprinted Feat button. Dial 00.
3 Select the feature or setting.	Press the button you labeled.
	 NOTE: If the feature does not get programmed onto a button, press any line button. This does not affect the button in any way.
	Dial the programming code. The feature is programmed.
4 End programming.	Press the imprinted Feat button. Dial 00.

System Programming Menu Hierarchy



The system programming menu hierarchy details the sequence of menu screens that appear when you select the system programming options. The choice of an option on the first menu screen leads to either a second menu screen or a data-entry screen. A second menu screen may lead to still another menu screen, and so on, up to six screens, as shown on the following pages.

You can use the Inspect feature in system programming to display the telephone or line/trunk numbers that are programmed with a specific feature. Inspect is helpful either when you must assign a feature to many lines/trunks or extensions and you do not have a Direct Station Selector (DSS) attached to the system programming console, or when you are programming using a PC with the SPM (System Programming and Maintenance) program.

Inspect can be used with the menu options on the following pages that have an asterisk (*) next to them. To use Inspect in system programming, choose an eligible option, and press either Inspct or PgDn.

Sample Reports

F

This appendix includes samples of the print reports generated by the communications system. [Table F-1](#) lists the system reports and the pages in this appendix where samples can be found.



NOTE:

The system's Station Message Detail Recording (SMDR) feature reports incoming and outgoing call details.

Table F-1. Sample Report Pages

For...	See...
System Information Report	F-7
Dial Plan Report	F-9
Non-Local Dial Plan Report	F-12
Label Information Report	F-13
Tie Trunk Information Report	F-14
DID Trunk Information Report	F-15
GS/LS Trunk Information Report	F-16
General Trunk Information Report	F-17
DS1 Information Report	F-18
PRI Information Report	F-19
Remote Access (DISA) Information Report	F-23

Table F-1. Sample Report Pages — Continued

For...	See...
Operator Information Report	F-24
Allowed Lists Report	F-26
Access to Allowed Lists Report	F-27
Disallowed Lists Report	F-28
Access to Disallowed Lists Report	F-29
Automatic Route Selection Report	F-30
Extension Directory Report	F-31
System Directory Report	F-32
Group Paging Report	F-33
Extension Information Report	F-34
Group Coverage Information Report	F-36
Direct Group Calling Information Report	F-37
Night Service Information Report	F-39
Group Call Pickup Report	F-40
Error Log Report	F-41
Authorization Code Information Report	F-42
BRI Information Report	F-43
Switch 56 Data Information Report	F-44

[Table F-2](#) lists all of the system reports and includes the print menu option used to print each report, the report name, and a brief description of each report.

To access the menu options in [Table F-2](#), select the `Print` option on the System Programming menu.

Table F-2. System Reports

Menu Option	Report Name	Description
All		Prints each of the reports available on the Print menu, from <code>SysSet-up</code> to Error Log.
		 NOTE: With <code>All</code> selected, four trunk information reports automatically print. See <code>Trunk Info</code> .
<code>SysSet-up</code>	System Information	Systemwide information such as return intervals, system mode, system programming port, slot assignments, and so on.
<code>Dial Plan</code>	Dial Plan	Extensions assigned to pools, paging zones, calling groups, lines or trunks, and stations (in the report); labels for lines/trunks and stations.
<code>Labels</code>	Label Information	Labels assigned to stations (extensions), Posted Messages, and names and telephone numbers in MLX-20L Personal Directory.
<code>Trunk Info</code>		Select to display four trunk options: <code>Tie</code> , <code>DID</code> , <code>Loop/Ground</code> , <code>General</code> .
<code>TIE</code>	TIE Trunk Information	Extensions assigned to and signaling attributes associated with Tie trunks.
<code>DID</code>	DID Trunk Information	Extensions assigned to and signaling attributes associated with DID trunks.
<code>Loop/ Ground</code>	GS/LS Trunk Information	Extensions assigned to signaling attributes for ground- and loop-start lines/trunks.
<code>General</code>	General Trunk Information	All identified extensions and feature-related attributes of each extension.
<code>T1 Info</code>	DS1 information	Options (line, signal, and so on) assigned to T1 trunks or lines.
<code>PRI Info</code>	PRI Information	PRI trunks assigned to B-channel groups.

Table F-2. System Reports — Continued

Menu Option	Report Name	Description
Rmote Access	Remote Access (DISA) Information	Remote access dial code, class of restriction, barrier code information.
Oper Info	Operator Information	For each system operator position: logical ID, extension number, label, type (DLC or QCC). All general system operator options—such as backup position, call types, and priorities.
AllowList	Allowed Lists	Telephone numbers included in Allowed Lists. Lists numbered 0–7; entries numbered 0–9.
AllowListTo	Access to Allowed Lists	Lists numbered 0–7. If the Allowed List is assigned to remote access users and barrier codes are used, barrier codes are numbered 0–16. If no barrier codes are used, 17 means list is assigned to tie-trunk users and 18 means list is assigned to non-tie-trunk users.
DisallowLst	Disallowed Lists	Telephone numbers included in Disallowed Lists. Lists are numbered 0–7, and entries are numbered 0–9.
DisallowTo	Access to Disallowed Lists	Telephones to which Disallowed Lists are assigned. Lists are numbered 0–7. If the Disallowed List is assigned to Remote Access users and barrier codes are used, the barrier codes are numbered 0–16. If no barrier codes are used, 17 means the Disallowed List is assigned to tie-trunk users and 18 means the Disallowed List is assigned to non-tie-trunk users.
ARS	Automatic Route Selection	Access code; table types with area codes and exchanges; routes for subpatterns A and B, FRL, absorb digit, delete digit, Dial 0, and N11 tables.

Table F-2. System Reports — Continued

Menu Option	Report Name	Description
Ext Direct	Extension Directory	Slot/port addresses, extensions, labels, and feature-related attributes. Column headings are printed on the first page only and are not carried over to subsequent pages. Column headings 4 through 10 (and 14 through 20) should be read vertically. That is: FACE (Forced Account Code Entry); HBIS (HFAI/BIS); RCFW (Remote Call Forward); MICD (Microphone Disable); SIG (Voice Signal); RSTR (Calling Restrictions); ARSR (ARS Restriction Level); 2BDT (2B Data Capability).
Sys Direct	System Directory	System Speed Dial number, label and telephone number in System Directory, and whether number should display.
Group Page	Group Paging	Extension number for each group and the extension number of each telephone assigned to the group.
Ext Info	Extension Information	For each specified station (extension), type of equipment connected, features assigned, ESS supervisor status, and features assigned to each button. On this report, MLX-16DP telephones are reported as MLX-28D. As of Release 5.0, MLX-5 and MLX-5D telephones are reported as 5-button telephone sets. In releases prior to Release 5.0, MLX-5 and MLX-5D telephones are reported as MLX-10 and MLX-10D telephones, respectively.
GrpCoverage	Group Coverage Information	Extension number for each group and the extension number for each telephone assigned to the group. Information is printed only for calling groups with members and/or lines/trunks assigned.
GrpCalling	Direct Group Calling Information	Group calling options (hunt, type, message waiting, station, delay announcements, alarm thresholds, and so on), the extension number for each telephone assigned to the group, and the lines or trunks assigned to the group.

Table F-2. System Reports — Continued

Menu Option	Report Name	Description
Night Service	Night Service Information	The operator, password required, time-of-day, and Emergency Allowed List extension numbers.
NonLcl UDP	Non-Local Dial Plan	Ranges of extension numbers for non-local dial plan extensions connected to a networked external switch; pattern number associated with each range. For each pattern, shows Pool number, absorbed and prepended (other) digits, FRL, and call type (voice, data, or both).
Call Pickup	Group Call Pickup	Extension numbers for telephones assigned to each group; pickup groups numbered 1–30.
Error Log	Error Log	Error message and code, time and day error occurred, frequency of error. See the <i>Maintenance and Troubleshooting</i> guide.
Auth Code	Authorization Code Information	Authorization Code and permissions for extensions to which authorization codes are assigned.
BRI	BRI Information Report	Service Profile ID and Directory Number for each BRI line, flexible timers, and fixed timers and counters.
Switch 56	Switch 56 Data Information Report	Dial Plan Routing information and programmable options.

System Information Report

Print Menu Option: SysSet-up

SYSTEM INFORMATION

Current Date: 01/04/00
Current Time: 00:21:15
System : Mode AutoMaintBusy AutoBusyTie
: Hybrid/PBX Disable Disable
Language: SystemLang SMDR Printer
English English English
CTI Links : 19
Direct Line Operators : 14 18 22 42
Queued Call Operators: 10
SysProg Port: 10 Password : craftr4
Transfer : Type Audible OneTouch(Complete) ReturnTimer
: Ring MusicOnHold Transfer(Auto) 5 rings
VMS Transfer Return Interval : 4
Paging System Lines :
Music On Hold Line : 804
Camp On Time : 90 sec
Call Park Return Time : 180 sec
Auto Callback Rings : 3
Extension Status (ESS) : Group Call / CMS
ESS Operators :
SMDR : Min.CallTime CallReport Format
: 40 sec In/Out Basic
Intercom Dial Tone : Inside
Reminder Service Cancel : :
Behind Switch Code : Drop Transfer Conference
Inter-digit Timer (seconds) : 24 24 24 10 10 10 10 5 5
Recall Timer : 450 msec
Second Dial-tone Timer : 200 msec
Rotary Line Cut Through : Delay
Unassigned Extension : 10
Automatic Backup : Weekly - 04:30 Sunday
TI/PRI/BRI Clock Synchronization:
Primary Secondary Tertiary
02/01 Loop 04/01 Local 04/02 Local

System Information Report— Continued

Slot # 1:	008 MLX	
Slot # 2:	408	
Slot # 3:	008	
Slot # 4:	408	
Slot # 5:	800 GS/LS	
Slot # 6:	008 GS/LS-MLX	
Slot # 7:	800 CO-BRI	
Slot # 8:	008	
Slot # 9:	016 (Ringing Frequency - 25 Hz.)	
Slot #10:	408 GS/LS	
Slot #11:	008	
Slot #12:	800	
Slot #13:	800 DID	
Slot #14:	400 EM	
Slot #15:	012	
Slot #16:	008 MLX	
Slot #17:	408	* Not Present *

Dial Plan Report

Print Menu Option: Dial Plan
Sections: Pools; Telephone Paging Zones; Direct Group Calling Group;
Lines/Trunks; Stations

DIAL PLAN FOR POOLS

POOL.# 1: 70
POOL.# 2: 890
POOL.# 3: 891
POOL.# 4: 892
POOL.# 5: 893
POOL.# 6: 894
POOL.# 4: 895
POOL.# 8: 896
POOL.# 9: 897
POOL.# 10: 898
POOL.# 11: 899

DIAL PLAN FOR TELEPHONE PAGING ZONES

TPZ # 1: 793
TPZ # 2: 794
TPZ # 3: 795
TPZ # 4: 796
TPZ # 5: 797
TPZ # 6: 798
TPZ # 7: 799

DIAL PLAN FOR DIRECT GROUP CALLING GROUP

DGCG # 1: 770
DGCG # 2: 771
DGCG # 3: 772
DGCG # 4: 773
DGCG # 5: 774
.
.
.
DGCG # 32: 7929

DIAL PLAN FOR LINES/TRUNKS

LINE # 1:	801	OUTSIDE	LINE # 2:	802	OUTSIDE
LINE # 3:	803	OUTSIDE	LINE # 4:	804	OUTSIDE
LINE # 5:	805	OUTSIDE	LINE # 6:	806	OUTSIDE
LINE # 7:	807	OUTSIDE	LINE # 8:	808	OUTSIDE
LINE # 9:	809	OUTSIDE	LINE # 10:	810	OUTSIDE
.			.		
.			.		
.			.		
LINE # 79:	879	OUTSIDE	LINE # 80:	880	OUTSIDE

Dial Plan Report—Continued

DIAL PLAN FOR STATIONS

STN #:	1	10	OPERATR	STN	#: 2	710	
STN #:	3	11		STN	#: 4	711	
STN #:	5	12		STN	#: 6	712	
STN #:	7	13	EXT 13	STN	#: 8	713	
STN #:	9	14	EXT 14	STN	#: 10	714	
STN #:	11	15		STN	#: 12	715	
STN #:	13	16		STN	#: 14	716	
STN #:	15	17		STN	#: 16	717	
STN #:	17	18	EXT 18	STN	#: 18	19	
STN #:	19	20		STN	#: 20	21	
STN #:	21	22	OPERATR	STN	#: 22	23	
STN #:	23	24		STN	#: 24	25	
STN #:	25	26		STN	#: 26	21	
STN #:	27	28		STN	#: 28	29	
STN #:	29	30	AUDIXVP	STN	#: 30	31	AUDIXVP
STN #:	31	32	AUDIXVP	STN	#: 32	33	AUDIXVP
STN #:	33	34		STN	#: 34	35	
STN #:	35	36		STN	#: 36	31	
STN #:	37	38		STN	#: 38	39	
STN #:	39	40		STN	#: 40	41	
STN #:	41	42	EXT 42	STN	#: 42	742	
.				.			
.				.			
.				.			
STN #:	121	7198		STN	#: 122	7398	
STN #:	123	5555		STN	#: 124	7399	

Dial Plan Report—Continued

COMPLETE DIAL PLAN FOR STATIONS AND ADJUNCTS

ID #:	1	4000	7300	ID #:	2	4001	7301
ID #:	3	4002	7302	ID #:	4	4003	7303
ID #:	5	4004	7304	ID #:	6	4005	7305
ID #:	7	4006	7306	ID #:	8	4007	7307
ID #:	9	4008	7308	ID #:	10	4009	7309
ID #:	11	4010	3000	ID #:	12	4011	3001
ID #:	13	4012	3002	ID #:	14	4013	3003
ID #:	15	4014	3004	ID #:	16	4015	3005
ID #:	17	4016	3006	ID #:	18	4017	3007
ID #:	19	4018	3008	ID #:	20	4019	3009
ID #:	21	4020	3010	ID #:	22	4021	3011
ID #:	23	4022	3012	ID #:	24	4023	3013
ID #:	25	4024	3014	ID #:	26	4025	3015
ID #:	27	4026	3016	ID #:	28	4027	3017
ID #:	29	4028	3018	ID #:	30	4029	3019
ID #:	31	4030	3020	ID #:	32	4031	3021
ID #:	33	4032	3022	ID #:	34	4033	3023
ID #:	35	4034	3024	ID #:	36	4035	3025
ID #:	37	4036	3026	ID #:	38	4037	3027
ID #:	39	4038	3028	ID #:	40	4039	3029
ID #:	41	4040	3030	ID #:	42	4041	3031
ID #:	43	4042	3032	ID #:	44	4043	3033
ID #:	45	4044	3034	ID #:	46	4045	3035
ID #:	47	4046	3036	ID #:	48	4047	3037
ID #:	49	4048	3038	ID #:	50	4049	3039
ID #:	51	4050	3040	ID #:	52	4051	7351
ID #:	53	4052	3042	ID #:	54	4053	7353
ID #:	55	4054	7354	ID #:	56	4055	7355
ID #:	57	4056	7356	ID #:	58	4057	7357
ID #:	59	4058	7358	ID #:	60	4059	7359
ID #:	61	7160	7360	ID #:	62	7161	7361
ID #:	63	7162	7362	ID #:	64	7163	7363
ID #:	65	7164	7364	ID #:	66	7165	7365
ID #:	67	7166	7366	ID #:	68	7167	7367
ID #:	69	7168	7368	ID #:	70	7169	7369
.				.			
.				.			
.				.			
ID #:	191	5151	7490	ID #:	192	5152	7491
ID #:	193	5153	7492	ID #:	194	5154	7493
ID #:	195	5155	7494	ID #:	196	5156	7495
ID #:	197	5156	7496	ID #:	198	5158	7497
ID #:	199	5158	7498	ID #:	200	5160	7499

F Sample Reports

Non-Local Dial Plan Report

F-12

Non-Local Dial Plan Report

Print Menu Option: NonLcl UDP (Release 6.0 and later systems only)
Sections: Ranges; Patterns

	Range	Ptn		Range	Ptn		Range	Ptn		Range	Ptn
01)	2400-2449	01	14)	5000-5049	09	27)	7000-7049	12	39)	8050-8059	15
02)	2550-2559	02	15)	5050-5079	10	28)	7050-7050	20	40)	8060-8069	03
03)	2560-2569	03	16)	5080-5099	01	29)	7051-7059	01	41)	8070-8099	04
04)	2570-2589	04	17)	5100-5199	02	30)	7060-7099	02	42)	8100-8199	05
05)	2590-2609	04	18)	5200-5200	11	31)	7100-7119	03	43)	8200-8229	06
06)	2610-2649	05	19)	5201-5202	12	32)	7220-7449	04	44)	8230-8259	16
07)	2650-2679	06	20)	5203-5204	13	33)	7450-7549	05	45)	8260-8289	17
08)	3100-3109	07	21)	5205-5206	14	34)	7550-7589	06	46)	8290-8389	18
09)	3110-3129	07	22)	5207-5209	15	35)	7590-7609	07	47)	8390-8429	19
10)	3130-3159	02	23)	5210-5230	03	36)	7610-7709	08	48)	8430-8459	20
11)	3160-3179	06	24)	5231-5250	17	37)	7710-7809	09	49)	8460-8489	03
12)	3180-3199	08	25)	5251-5270	18	38)	7810-7899	10	50)	8490-8499	02
13)	4000-4025	08	26)	6050-6079	14						

Pattern 01:

Pool	Absorb	Other Digits	FRL	Call type
1)3871	00		0	BOTH
2)3892	00		0	BOTH
3)3893	00		0	BOTH
4)3894	00	9957	0	BOTH

Pattern 02:

Pool	Absorb	Other Digits	FRL	Call type
1)4590	00		2	BOTH
2)4592	00		2	Voice
3)3893	00		0	BOTH
4)3894	00	9957	0	BOTH
.
.

Pattern 20:

Pool	Absorb	Other Digits	FRL	Call type
1)4591	00		3	Data
2)4592	00		3	Data
3)3894	00	9957	3	BOTH
4)3870	00	9957	4	BOTH

Label Information Report

Print Menu Option: Labels

Sections: Telephone Personal Directory; Posted Messages and Numbers

LABEL INFORMATION

Executive Telephone # 10: Personal Directory

Name	Number	Display
------	--------	---------

Executive Telephone # 14: Personal Directory

Name	Number	Display
------	--------	---------

Executive Telephone # 15: Personal Directory

Name	Number	Display
------	--------	---------

MSG # POSTED MESSAGE

- | | |
|----|-----------------|
| 1 | DO NOT DISTURB |
| 2 | OUT TO LUNCH |
| 3 | AT HOME |
| 4 | OUT SICK |
| 5 | IN A MEETING |
| 6 | IN CONFERENCE |
| 7 | WITH A CLIENT |
| 8 | WITH A CUSTOMER |
| 9 | AWAY FROM DESK |
| 10 | OUT ALL DAY |
| 11 | CUSTM MSG11 |
| 12 | CUSTM MSG12 |
| 13 | CUSTM MSG13 |
| 14 | CUSTM MSG14 |
| 15 | CUSTM MSG15 |
| 16 | CUSTM MSG16 |
| 17 | CUSTM MSG17 |
| 18 | CUSTM MSG18 |
| 19 | CUSTM MSG19 |
| 20 | CUSTM MSG20 |

Tie Trunk Information Report

Print Menu Option: Trunk Info and TIE

TIE TRUNK INFORMATION

TRUNK	849	Slot/Port : 14/ 1	TIE-PBX
Direction:	2 Way	E&M Signal: Type1S	Dialtone : Remote
InType	: Wink	InMode : Rotary	AnsSupvr : 300 ms
OutType	: Wink	OutMode : Rotary	Disconnect: 300 ms

TRUNK	850	Slot/Port : I4/ 2	TIE-PBX
Direction:	2 Way	E&M Signal: Type1S	Dialtone : Remote
InType	: Wink	InMode : Rotary	AnsSupvr : 300 ms
OutType	: Wink	OutMode : Rotary	Disconnect: 300 ms

TRUNK	851	Slot/Port : 14/ 3	TIE-PBX
Direction:	2 Way	E&M Signal: Type1S	Dialtone : Remote
InType	: Wink	InMode : Rotary	AnsSupvr : 300 ms
OutType	: Wink	OutMode : Rotary	Disconnect: 300 ms

TRUNK	852	Slot/Part : 14/ 4	TIE-PBX
Direction:	2 Way	E&M Signal: Type1S	Dialtone : Remote
InType	: Wink	InMode : Rotary	AnsSupvr : 300 ms
OutType	: Wink	OutMode : Rotary	Disconnect: 300 ms

DID Trunk Information Report

Print Menu Option: Trunk Info and DID

DID TRUNK INFORMATION

Trk	SS/PP	Blk	DiscTime	Type	ExpDig	DelDig	AddDig	Signal	InvDest
841	13/ 1	1	500ms	Wink	4	3	1	TouchTone	BkupExt
842	13/ 2	1	500ms	Wink	4	3	1	TouchTone	BkupExt
843	13/ 3	2	500ms	Wink	3	0		Rotary	BkupExt
844	13/ 4	2	500ms	Wink	3	0		Rotary	BkupExt
845	13/ 5	1	500ms	Wink	4	3	1	TouchTone	BkupExt
846	13/ 6	1	500ms	Wink	4	3	1	TouchTone	BkupExt
847	13/ 7	2	500ms	Wink	3	0		Rotary	BkupExt
848	13/ 8	1	500ms	Wink	4	3	1	TouchTone	BkupExt

GS/LS Trunk Information Report

Print Menu Option: Trunk Info and Loop/Ground

GS/LS TRUNK INFORMATION

Trk	SS/PP	Type	OutMode	RelDisc	ChannelUnit	LS-ID	Delay
801	2/ 1	Loop	TouchTone	Yes	N/A		N/A
802	2/ 2	Loop	TouchTone	Yes	N/A		N/A
803	2/ 3	Loop	TouchTone	Yes	N/A		N/A
804	2/ 4	Loop	TouchTone	Yes	N/A		N/A
805	4/ 1	Loop	Rotary	Yes	N/A		N/A
806	4/ 2	Loop	Rotary	Yes	N/A		N/A
807	4/ 3	Loop	Rotary	Yes	N/A		N/A
808	4/ 4	Loop	Rotary	Yes	N/A		N/A
809	5/ 1	Ground	TouchTone	N/A	N/A		N/A
810	5/ 2	Ground	TouchTone	N/A	N/A		N/A
811	5/ 3	Loop	Rotary	Yes	N/A		N/A
812	5/ 4	Loop	Rotary	Yes	N/A		N/A
813	5/ 5	Loop	Rotary	Yes	N/A		N/A
814	5/ 6	Loop	Rotary	Yes	N/A		N/A
815	5/ 7	Loop	TouchTone	Yes	N/A		N/A
816	5/ 8	Loop	Rotary	Yes	N/A		N/A
817	6/ 1	Ground	Rotary	N/A	N/A		N/A
.							
.							
879	15/ 7	LS-ID	Rotary	Yes	N/A		Yes
880	15/ 8	LS-ID	Rotary	Yes	N/A		No

General Trunk Information Report

Print Menu Option: Trunk Info and General

GENERAL TRUNK INFORMATION

Trk	SS/PP	RemAccess	Pool	TlPrfx	HldDisc	Principal	QCC Prtly	QCC Oper	Extern Switch
801	2/1	No Remote	70	Yes	Long		4		60
802	2/2	No Remote	70	Yes	Long		4		02
803	2/3	No Remote	70	Yes	Long		4		21
804	2/4	No Remote		Yes	Long				
805	4/1	No Remote		Yes	Long				
806	4/2	No Remote		Yes	Long		4		
807	4/3	No Remote		Yes	Long		4		
808	4/4	No Remote		Yes	Long		4		
809	5/1	No Remote		Yes	Long		4	10	
810	5/2	No Remote	890	Yes	Long		4		
811	5/3	No Remote		Yes	Long		4		
812	5/4	No Remote		Yes	Long		4		
813	5/5	No Remote		Yes	Long		4		
814	5/6	No Remote		Yes	Long		4		
815	5/7	No Remote		Yes	Long		4		
816	5/8	No Remote		Yes	Long		4		
817	6/1	Dedicated		Yes	Long	42	4		
.
.
912	10/1	No Remote		Yes	Long		4		12
913	10/2	No Remote		Yes	Long		4		13

DS1 Information Report

Print Menu Option: T1 Info

DS1 SLOT ATTRIBUTES

Slot	Type	Format	Supp	Signal	LineComp	ClkSync	Src	Active
2	T1	D4	ZCS	Rob Bit	1	Prim	Loop	Yes
3	T1	D4	ZCS	Rob Bit	1	None	Local	Yes

PRI Information Report

Print Menu Option: PRI Info
Sections: Network Selection, Special Service, Call-by-Call and Dial Plan
Routing Tables; PRI Information

Slot 5 Switch: DMS-100

Slot 11 Switch: Legend-PBX

Slot 12 Switch: Legend-PBX

System: By line

BcchnlGrp #:	Slot:	TestTelNum:	NtwkServ:	Incoming Routing:
5	5		CallbyCall	By Dial Plan

Channel ID:	23	22	21	20	19	18	17	16	15	14
	13	12	11	10	9	8	7	6	5	4
	3	2	1							

Line	PhoneNumber	NumberToSend
801		
802		
803		
804		
805		
806		
807		
808		
809		
810		
811		
812		
813		
814		
815		
816		
817		
818		
819		
820		
821		
822		
823		

PRI Information Report—Continued

BchnlGrp #: Slot: TestTelNum: NtwkServ: Incoming Routing:
79 12 ElecTandNtwkRoute Directly to UDP

Channel ID: 1 2 3 4 5 6 7 8 9 10
11 12 13 14 15 16 17 18 19 20
21 22 23

Line	PhoneNumber	NumberToSend
849		
850		
851		
852		
853		
854		
855		
856		
857		
858		
859		
860		
861		
862		
863		
864		
865		
866		
867		
868		
869		
870		
871		

BchnlGrp #: Slot: TestTelNum: NtwkServ: Incoming Routing:
80 11 ElecTandNtwk Route Directly to UDP

Channel ID: 1 2 3 4 5 6 7 8 9 10
11 12 13 14 15 16 17 18 19 20
21 22 23

Line	PhoneNumber	NumberToSend
825		
826		
827		
828		
829		

PRI Information Report—Continued

830
 831
 832
 833
 834
 835
 836
 837
 838
 839
 840
 841
 842
 843
 844
 845
 846
 847

Network Selection Table

Entry Number:	0	1	2	3
Pattern to Match:	101****	10***		

Special Service Table

Entry Number:	0	1	2	3	4	5	6	7
Pattern to Match:	011	010	01	00	0	1		
Operator:	none	OP	OP	OP/P	none	none	none	none
Type of Number:	I	I	I	N	N	N	N	N
Digits to Delete:	3	3	2	2	1	0	0	0

Call-By-Call Service Table

Entry Number:	0	1	2	3	4
Pattern 0:	957	7			
Pattern 1:		1			
Pattern 2:		2			
Pattern 3:		3			
Pattern 4:		4			
Pattern 5:		5			
Pattern 6:		6			
Pattern 7:		7			
Pattern 8:		8			

PRI Information Report—Continued

Pattern	9:	9			
Call Type:	BOTH	BOTH	BOTH	BOTH	BOTH
NtwkServ:	DMS-Private	DMS-Private			
DeleteDigits:	0	0	0	0	0
Entry Number:	5	6	7	8	9
Call Type:	BOTH	BOTH	BOTH	BOTH	BOTH
NtwkServ:					
DeleteDigits:	0	0	0	0	0

Dial Plan Routing Table

Entry Number:	0	1	2	3
NtwkServ:	Any service	Any service	Any service	
Expected Digits:	4	7	10	0
Pattern to Match:				
Digits to Delete:	0	7	10	0
Digits to Add:		13	13	
Entry Number:	4	5	6	7
NtwkServ:				
Expected Digits:	0	0	0	0
Pattern to Match:				
Digits to Delete:	0	0	0	0
Digits to Add:				
Entry Number:	8	9	10	11
NtwkServ:				
Expected Digits:	0	0	0	0
Pattern to Match:				
Digits to Delete:	0	0	0	0
Digits to Add:				
Entry Number:	12	13	14	15
NtwkServ:				
Expected Digits:	0	0	0	0
Pattern to Match:				
Digits to Delete:	0	0	0	0
Digits to Add:				

Remote Access (DISA) Information Report

Print Menu Option: Rmote Access
Sections: **General Options; System Default Class of Restrictions (Non-TIE); System Default Class of Restrictions (TIE); Barrier Code Administration**

GENERAL OPTIONS (ACCESS CODE 889)

Barrier Code required for Non-TIE DISA lines : Yes
Barrier Code required for TIE DISA lines :No
Automatic Queuing enabled for DISA lines :Yes
System Wide Barrier Code Length: 07
Date And Time of Last Barrier Code Length Change: 09:23:94, 09:45 PM

SYSTEM DEFAULT CLASS OF RESTRICTIONS (NON-TIE)

Restriction : UNRESTRICTED
ARS Restriction Level: 3
Allowed Lists :
Disallowed Lists :

SYSTEM DEFAULT CLASS OF RESTRICTIONS (TIE)

Restriction : UNRESTRICTED
ARS Restriction Level: 3
Allowed Lists :
Disallowed Lists :

BARRIER CODE ADMINISTRATION

Barrier Code number : 1
Barrier Digits : 2468345
Restriction : OUTWARD RESTRICTED
ARS Restriction Level: 3
Allowed Lists :
Disallowed Lists :

Barrier Code number : 2
Barrier Digits : 1234693
Restriction : UNRESTRICTED
ARS Restriction Level: 3
Allowed Lists :
Disallowed Lists :

.

Barrier Code number : 16
Barrier Digits : 9876115
Restriction : OUTWARD RESTRICTED
ARS Restriction Level: 0
Allowed Lists :
Disallowed Lists :

Operator Information Report

Print Menu Option: Oper Info

Sections: Operator Positions; General Options; DSS Options; QCC
Operator Options; QCC Call Types

OPERATOR POSITIONS

PORT				CALL ALERT
ADDR.	EXT #	LABEL	TYPE	(QCC ONLY)
====	=====	=====	=====	=====
1/ 1	10	OPERATR	QCC	No
1/ 5	14	EXT 14	DLC	N/A
2/ 1	18	EXT 18	DLC	N/A
2/ 5	22	OPERATR	DLC	N/A
6/ 1	42	EXT 42	DLC	N/A

GENERAL OPTIONS

Length of hold reminder timer: 60 sec
DLC Automatic hold enabled : No

DIRECT STATION SELECTOR (DSS) OPTIONS

BUTTON	FIRST
NUMBER	DIAL CODE
=====	=====
1	0
2	50
3	100

Operator Call Park codes: 881 882 883 884 885 886 884 888

QCC OPERATOR OPTIONS

Listed Directory Number for queue : 800
Held calls return to queue : No
Automatic hold enabled : No
Calls-in-queue alarm threshold : 0
Time until priorities are elevated: 0 sec
Message Center Operators :
One Touch Extend : AUTOMATIC
Rings before extended calls return: 4
Backup operator station :
Voice Announce on Call 5 button : Disable

Operator Information Report— Continued

QCC CALL TYPES:		
CALL TYPE	PRIORITY	OPERATORS
=====	=====	=====
Dial 0 Operator	4	10
Follow Forward	4	N/A
Unassigned DID	4	10
Listed Directory Number	4	10
Operator's Extension	4	N/A
Returning	4	0
Group Coverage		
Group # 1	4	
Group # 2	4	
Group # 3	4	
Group # 4	4	
Group # 5	4	
Group # 6	4	
Group # 7	4	
Group # 8	4	
Group # 9	4	
Group # 10	4	
Group # 11	4	
Group # 12	4	
Group # 13	4	
Group # 14	4	
Group # 15	4	
Group # 16	4	
Group # 17	4	
Group # 18	4	
Group # 19	4	
Group # 20	4	
Group # 21	4	
Group # 22	4	
Group # 23	4	
Group # 24	4	
Group # 25	4	
Group # 26	4	
Group # 27	4	
Group # 28	4	
Group # 29	4	
Group # 30	4	

Allowed Lists Report

Print Menu Option: AllowList
Sections: Lists 1 through 7

ALLOWED LISTS

List : 0

Entry 0: -----
Entry 1: -----
Entry 2: -----
Entry 3: -----
Entry 4: -----
Entry 5: -----
Entry 6: -----
Entry 7: -----
Entry 8: -----
Entry 9: -----

.
.
.

List : 7

Entry 0: -----
Entry 1: -----
Entry 2: -----
Entry 3: -----
Entry 4: -----
Entry 5: -----
Entry 6: -----
Entry 7: -----
Entry 8: -----
Entry 9: -----

Access to Allowed Lists Report

Print Menu Option: AllowListTo

ACCESS TO ALLOWED LISTS

FOR REMOTE ACCESS 17 & 18 MEAN TIE & NON-TIE RESTRICTIONS

List	1	STNS	10		
		RACC	1	17	18
List	3	STNS	33		
		RACC			

Disallowed Lists Report

Print Menu Option: DisallowLst
Sections: Lists 1 through 7

DISALLOWED LISTS

List : 0

Entry 0: -----
Entry 1: -----
Entry 2: -----
Entry 3: -----
Entry 4: -----
Entry 5: -----
Entry 6: -----
Entry 7: -----
Entry 8: -----
Entry 9: -----

.
.
.

List : 7

Entry 0: -----
Entry 1: -----
Entry 2: -----
Entry 3: -----
Entry 4: -----
Entry 5: -----
Entry 6: -----
Entry 7: -----
Entry 8: -----
Entry 9: -----

Access to Disallowed Lists Report

Print Menu Option: DisallowTo

ACCESS TO DISALLOWED LISTS

FOR REMOTE ACCESS 17 & 18 MEAN TIE & NON-TIE RESTRICTIONS

List	1	STNS	33
		RACC	9
List	3	STNS	33
		RACC	

Automatic Route Selection Report

Print Menu Option: ARS
Sections: Tables

AUTOMATIC ROUTE SELECTION

ARS IS: ACTIVE ACCESS CODE: 9

TABLE 17: Default Toll Output Table

Pool	Absorb	Other Digits	FRL	Call type	Start	Pattern
1)70--	00	-----	3	BOTH	--:--	A
2)----	--	-----	-	-----	--:--	A
3)----	--	-----	-	-----	--:--	A
4)----	--	-----	-	-----	--:--	A
5)----	--	-----	-	-----	--:--	B
6)----	--	-----	-	-----	--:--	B

Pool	Absorb	Other Digits	FRL	Call type	Start	Pattern
1)70--	00	-----	3	BOTH	--:--	B
2)----	--	-----	-	-----	--:--	B
3)----	--	-----	-	-----	--:--	B
4)----	--	-----	-	-----	--:--	B
5)----	--	-----	-	-----	--:--	B
6)----	--	-----	-	-----	--:--	B

TABLE 18: Default Local Output Table

Pool	Absorb	Other Digits	FRL	Call type	Start	Pattern
1)70--	00	-----	3	BOTH	--:--	A
2)----	--	-----	-	-----	--:--	A
3)----	--	-----	-	-----	--:--	A
4)----	--	-----	-	-----	--:--	A
5)----	--	-----	-	-----	--:--	B
6)----	--	-----	-	-----	--:--	B

Pool	Absorb	Other Digits	FRL	Call type	Start	Pattern
1)70--	00	-----	3	BOTH	--:--	B
2)----	--	-----	-	-----	--:--	B
3)----	--	-----	-	-----	--:--	B
4)----	--	-----	-	-----	--:--	B
5)----	--	-----	-	-----	--:--	B

TABLE 19: Dial 0 Output Table

Pool	Absorb	Other Digits	FRL	Call type	Start	Pattern
1)70--	00	-----	3	BOTH	--:--	A

TABLE 20: N11 Output Table

01)411 02)611 03)811 04)911

Pool	Absorb	Other Digits	FRL	Call type	Start	Pattern
1)70--	00	-----	3	BOTH	--:--	A
1)70--	00	-----	3	BOTH	--:--	A

Extension Directory Report

Print Menu Option: Ext Direct

EXTENSION DIRECTORY

Port Addr	Ext #	Label	F H R M V R A 2 A B C I S S R B C I F C I T S D E S W D G R R T	Port Addr	Ext #	Label	F H R M V R A 2 A B C I S S R B C I F C I T S D E S W D G R R T
1/ 1	10	OPERATR	N N N N U 3 N	1/21	710		N N N N U 3 N
1/ 2	11		N N N N O 3 Y	1/22	711		N N N N U 3 N
1/ 3	12		N N N N U 3 Y	1/23	712		N N N N U 3 N
1/ 4	13	EXT 13	N N N N U 3 N	1/24	713		N N N N U 3 N
1/ 5	14	EXT 14	N N N N U 3 N	1/25	714		N N N N U 3 N
1/ 6	15		N N N N U 3 N	1/26	715		N N N N U 3 N
1/ 7	16		N N N N U 3 N	1/27	716		N N N N U 3 N
1/ 8	17		N N N N U 3 N	1/28	717		N N N N U 3 N
2/ 1	18	EXT 18	N Y N N U 3 N	2/ 2	19		N Y N N U 3 N
2/ 3	20		N Y N N U 3 N	2/ 4	21		N Y N N U 3 N
2/ 5	22	OPERATR	N Y N N U 3 N	2/ 6	23		N Y N N U 3 N
2/ 7	24		N Y N N U 3 N	2/ 8	25		N Y N N U 3 N
3/ 1	26		N Y N N U 3 N	3/ 2	27		N Y N N U 3 N
3/ 3	28		N Y N N U 3 N	3/ 4	29		N Y N N U 3 N
3/ 5	30	AUDIXVP	N Y N N U 3 N	3/ 6	31		N Y N N U 3 N
3/ 7	32	AUDIXVP	N Y N N U 3 N	3/ 8	33		N Y N N U 3 N
4/ 1	34		N Y N N U 3 N	4/ 2	35	AUDIXVP	N Y N N U 3 N
4/ 3	36	AUDIXVP	N Y N N U 3 N	4/ 4	37		N Y N N U 3 N
4/ 5	38		N Y N N U 3 N	4/ 6	39		N Y N N U 3 N
4/ 7	40		N Y N N U 3 N	4/ 8	41		N Y N N U 3 N
6/ 1	42	EXT 42	N N N N U 3 N	6/21	742		N N N N U 3 N
.							
.							
7/ 1	54	EXT 54	N N N N U 3 N	7/2	754		N N N N U 3 N

System Directory Report

Print Menu Option: Sys Direct

SYSTEM DIRECTORY

Code	Name	Number	Display
600	ABC Company	555-9999	YES
601	Jacques Smith	5551212	YES
605	Travel Agency	912015556677	YES

Group Paging Report

Print Menu Option: Group Page

GROUP PAGING

Group # 793 STNS : 20 21 22 23 24 25

Group # 794 STNS : 15 16 17 18 19

Extension Information Report— Continued

EXTENSION INFORMATION

Extn	SS/PP	Type	
10	1/ 1	MLX-20L + 1 DSS	
Button	34	Blank	Status None
Button	33	Blank	Status None
Button	32	Blank	Status None
Button	31	Blank	Status None
Button	30	Blank	Status None
Button	29	Blank	Status None
Button	28	Blank	Status None
Button	27	Blank	Status None
Button	26	Blank	Status None
Button	25	Blank	Status None
Button	24	Blank	Status None
Button	23	Blank	Status None
Button	22	Blank	Status None
Button	21	Blank	Status None
Button	20	Forced Release	Status None
Button	19	Pool Inspect	Status None
Button	18	Headset Auto Answer	Status Off
Button	17	Join	Status None
Button	16	Cancel	Status None
Button	15	Alarm Status	Status Off
Button	14	Night Service	Status Off
Button	13	Headset Status	Status Off
Button	12	Destination	Status None
Button	11	Release	Status None
Button	10	Position Busy	Status Off
Button	9	Send/Remove Message	Status None
Button	8	Handset/Headset Mute	Status Off
Button	7	Source	Status None
Button	6	Start	Status None
Button	5	Call 5	Status None
Button	4	Call 4	Status None
Button	3	Call 3	Status None
Button	2	Call 2	Status None
Button	1	Call 1	Status None

Group Coverage Information Report

Print Menu Option: GrpCoverage

GROUP COVERAGE INFORMATION

Group #	2	Senders	:	6802	6804								
Group #	5	Senders	:	10	11	12	13	14	18	19	20	42	
				44	45	47	6810						

DIRECT GROUP CALLING INFORMATION

Group # : 770 Group Type : AutoLogout
Call Distribution Type : CIRCULAR
Delay Announcement Ext # : 11
Message Waiting Station : 20
Calls-in-queue Threshold : 1
External Alert ext # : 21
Overflow Threshold (#) : 1
Overflow to DGC group # :

9999

Group Coverage : 1

No.	EXT #	LABEL
1		
2		
3		
4		
5		
6		
7		
8		
9		
10		
11		
12		
13		
14		
15		
16		
17		
18		
19		
20		

Direct Group Calling Information Report

Print Menu Option: Grp Calling
Sections: Each programmed group

DIRECT GROUP CALLING INFORMATION

Group # : 782 Group Type : AutoLogout
Call Distribution Type : CIRCULAR

PryAnn No.	Ext #	LABEL
1	27	ANN1
2	28	ANN2

Secondary Announcement Ext # : 29
Time Between Delay Announcements : 0
Repeat Secondary Announcement: NO
Message Waiting Station : NONE
Queue Control Limit: 99
Calls-in-queue Threshold 1: 1
Calls-in-queue Threshold 2: 1
Calls-in-queue Threshold 3: 1
External Alert ext # : NONE
Overflow Threshold (#) : 1
Overflow Threshold (Time): 0
Prompt-Based Overflow Option: No
Overflow to DGC group # : NONE

Group Coverage : 1

Member No.	EXT #	LABEL
1	12	
2	13	
3		
4		
5		
6		
7		
8		
9		
10		
11		
12		
13		
14		
15		
16		
17		
18		
19		
20		

LINES:

Direct Group Calling Information Report—*Continued*

DIRECT GROUP CALLING INFORMATION

Group Priority:16

Support Group:

Home Group(s)/Priority:

Night Service Information Report

Print Menu Option: Night Service

NIGHT SERVICE INFORMATION

OPERATOR	10	DGCG	#:	
		STNS	:	10
		LINEs	:	801
OPERATOR	14	DGCG	#:	
		STNS	:	14
		LINEs	:	804
OPERATOR	18	DGCG	#:	
		STNS	:	18
		LINEs	:	808
OPERATOR	22	DGCG	#:	
		STNS	:	22
		LINEs	:	822
OPERATOR	42	DGCG	#:	
		STNS	:	42
		LINEs	:	842

Password :
Current Day : OFF
Turn off at: Turn on at:
Sunday : :
Monday : :
Tuesday : :
Wednesday : :
Thursday : :
Friday : :
Saturday : :

Emergency Allowed List:

- 0)
- 1)
- 2)
- 3)
- 4)
- 5)
- 6)
- 7)
- 8)
- 9)

NS Excluded STNS:

61 62 63 64 65

Error Log Report

Print Menu Option: Error Log

ERROR LOG

Last 30 System Errors:

Message	ss/pp	Cnt	First	Last	Code
PRI SVC AUDIT TIMEOUT	00/00	-	-	01/08 00:00:53	7001
TIMEOUT COLD START	00/00	-	-	01/11 00:04:08	0001
PRI SVC AUDIT TIMEOUT	00/00	-	-	01/11 00:04:14	7001
TIMEOUT COLD START	00/00	-	-	01/21 00:22:14	0001
PRI SVC AUDIT TIMEOUT	00/00	-	-	01/03 00:22:14	7001
PRI SVC AUDIT TIMEOUT	00/00	-	-	01/04 00:22:14	7001
SOFTWARE COLD START	00/00	-	-	01/04 00:21:14	0003
SOFTWARE COLD START	00/00	-	-	01/04 00:21:14	0003
PRI SVC AUDIT TIMEOUT	00/00	-	-	01/04 00:21:14	7001
SOFTWARE COLD START	00/00	-	-	01/04 00:22:11	0003
PRI SVC AUDIT TIMEOUT	00/00	-	-	01/08 00:00:53	7001
TIMEOUT COLD START	00/00	-	-	02/11 00:04:08	0001
PRI SVC AUDIT TIMEOUT	00/00	-	-	02/11 00:04:14	7001
TIMEOUT COLD START	00/00	-	-	02/21 00:22:14	0001
PRI SVC AUDIT TIMEOUT	00/00	-	-	02/03 00:22:14	7001
PRI SVC AUDIT TIMEOUT	00/00	-	-	02/04 00:22:14	7001
SOFTWARE COLD START	00/00	-	-	02/04 00:21:14	0003
SOFTWARE COLD START	00/00	-	-	02/04 00:21:14	0003
PRI SVC AUDIT TIMEOUT	00/00	-	-	02/04 00:21:14	7001
SOFTWARE COLD START	00/00	-	-	02/04 00:22:11	0003
PRI SVC AUDIT TIMEOUT	00/00	-	-	02/08 00:00:53	7001
TIMEOUT COLD START	00/00	-	-	03/11 00:04:08	0001
PRI SVC AUDIT TIMEOUT	00/00	-	-	03/11 00:04:14	7001
TIMEOUT COLD START	00/00	-	-	03/21 00:22:14	0001
PRI SVC AUDIT TIMEOUT	00/00	-	-	03/03 00:22:14	7001
PRI SVC AUDIT TIMEOUT	00/00	-	-	03/04 00:22:14	7001
SOFTWARE COLD START	00/00	-	-	03/04 00:21:14	0003
SOFTWARE COLD START	00/00	-	-	03/04 00:21:14	0003
PRI SVC AUDIT TIMEOUT	00/00	-	-	03/04 00:21:14	7001
SOFTWARE COLD START	00/00	-	-	03/04 00:22:11	0003

Authorization Code Information Report

Print Menu Option: Auth Code

SMDR Option for the Account Code Field is Home Extension

Extension	Authorization Code
10	3124
15	1357921
20	6578
23	443796

BRI Information Report

Print Menu Option: BRI

BRI INFORMATION

Flexible Timers:

T200 = 1000 ms T203 = 33 sec T303 = 4 sec T305 = 30 sec T308 = 4 sec

Fixed Timers and Counters:

T202 = 2 sec T309 = 90 sec T310 = 60 sec T313 = 4 sec
K Cntr = 1 N200 = 3 N201 = 260 N202 = 3

Line	Service Profile ID	Directory Number
801	908555100001	9085551000
802	908555100101	9085551001
803	908555100201	9085551002
804	908555100301	9085551003
805	908555100401	9085551004
806	908555100501	9085551005
807	908555100601	9085551006
808	908555100701	9085551007

Switch 56 Data Information Report

Print Menu Option: Switch 56

Dial Plan Routing for Network Service

Expected Digits: 3

Digits to Delete: 0

Digits to Add: 0

Trk	ss/pp	Dirction	InType	OutType	AnsSup	Discnt	Inmode	Outmode	Service
801	02/01	2 Way	Wink	Wink	120	180	T-Tone	T-Tone	TIE
802	02/02	Outgoing	Delay	Delay	160	180	Rotary	T-Tone	S56
803	02/03	Incoming	Auto	Auto	100	140	Rotary	Rotary	S56
.									
.									
.									
808	02/08	2 Way	Wink	Wink	120	180	Rotary	Rotary	TIE

Button Diagrams

G

This appendix contains the button diagrams for Hybrid/PBX, Key, and Behind Switch systems.

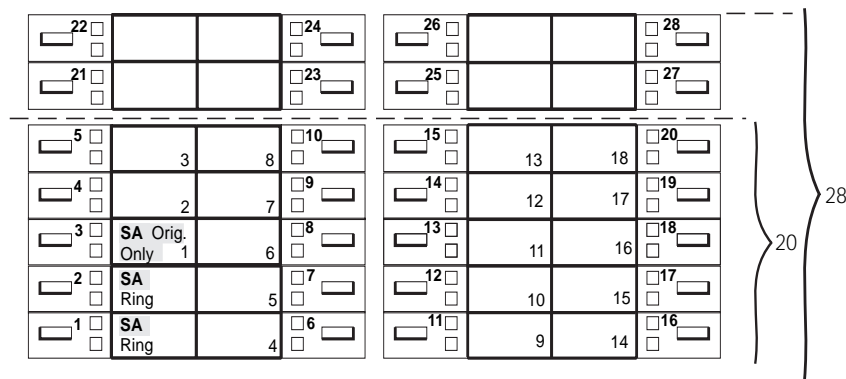

Figure G-1. MLX-20L and MLX-28D Telephone (Hybrid/PBX Mode)

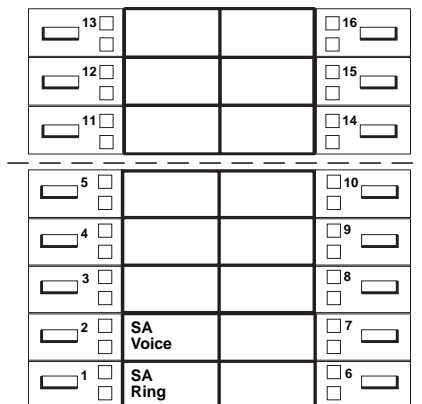

Figure G-2. MLX-16DP Telephone (Hybrid/PBX Mode)

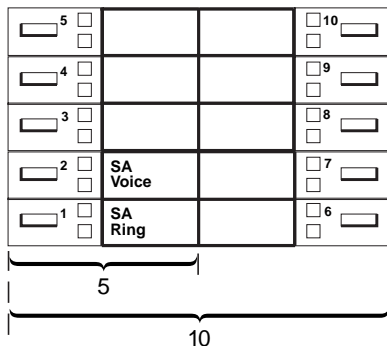

Figure G-3. MLX 5- and 10-Button Telephone (Hybrid/PBX Mode)

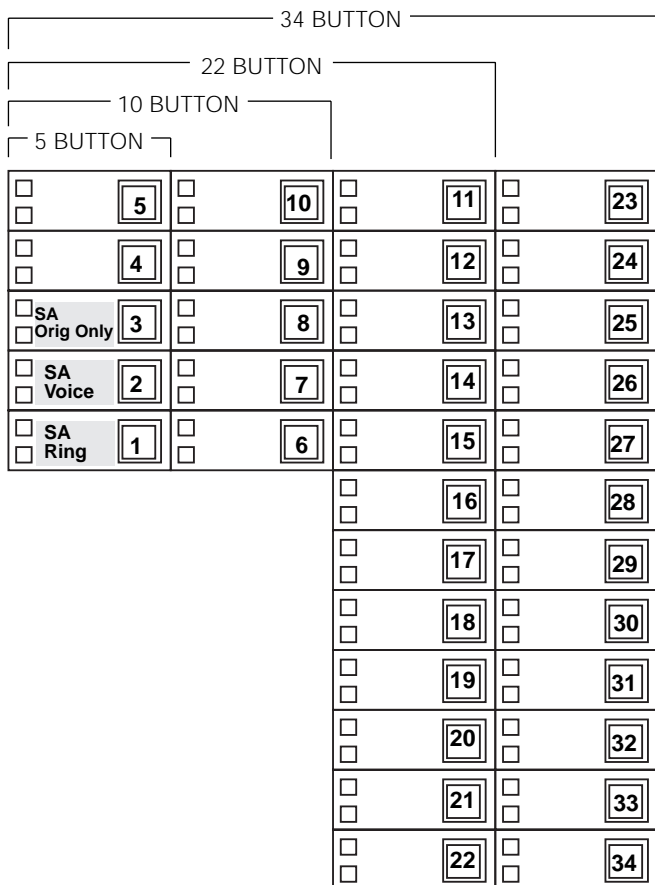

Figure G-4. Analog Multiline Telephone (Hybrid/PBX Mode)

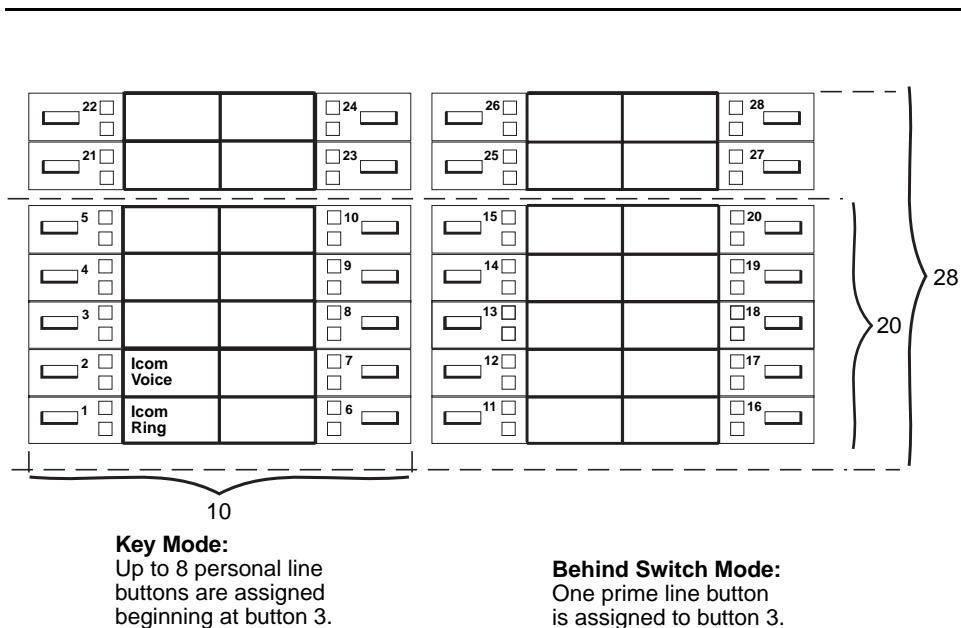

Figure G-5. MLX-20L and MLX-28D Telephone (Key and Behind Switch Modes)

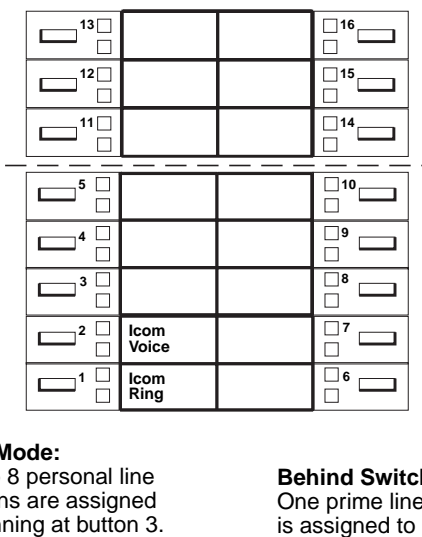
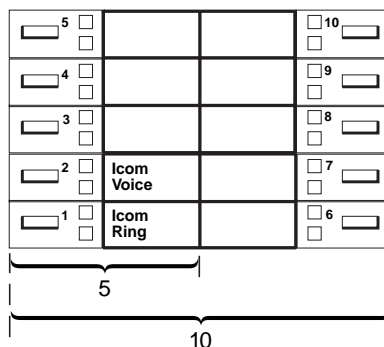
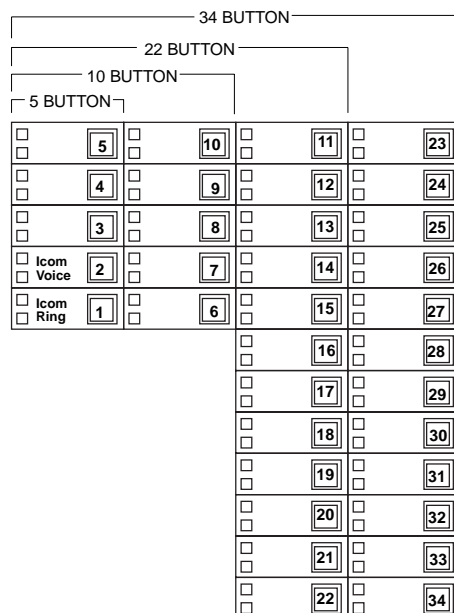

Figure G-6. MLX-16DP Telephone (Key and Behind Switch Modes)



Behind Switch Mode:
 One prime line is assigned
 to button 3.

Figure G-7. MLX 5- and 10-Button Telephone (Key and Behind Switch Modes)



Key Mode:
 Up to 8 Personal line
 buttons are assigned
 beginning at button 3.

Behind Switch Mode:
 One prime line button
 is assigned to button 3.

Figure G-8. Analog Multiline Telephone (Key and Behind Switch Modes)

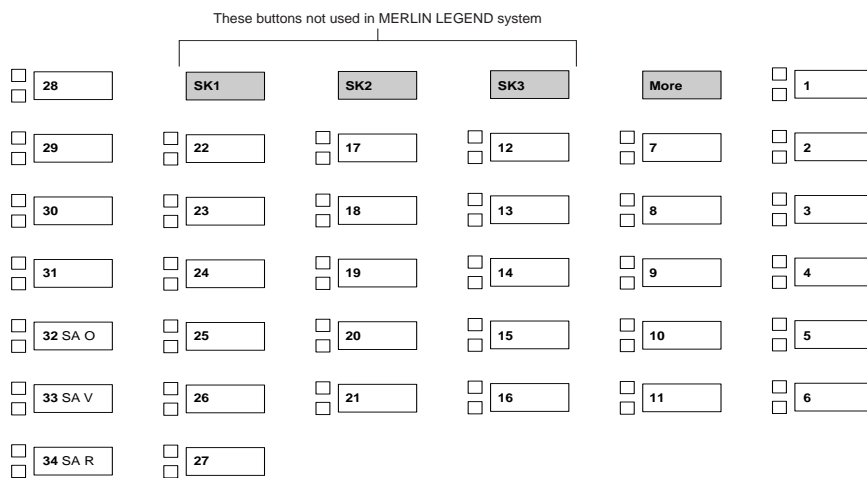

Figure G-9. ETR-34D Telephone (Hybrid/PBX Mode)

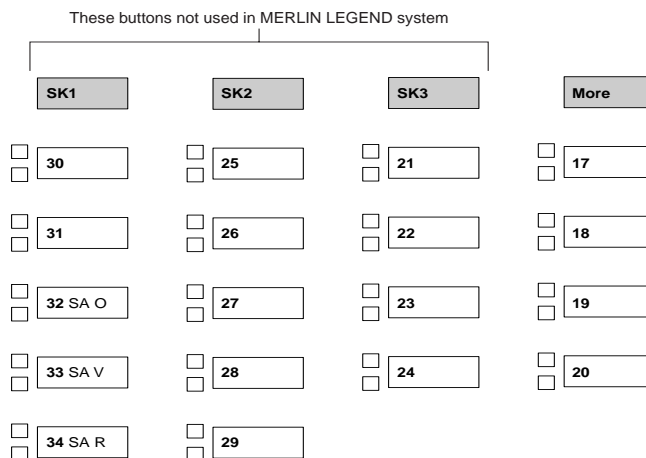

Figure G-10. ETR-18/18D Telephone (Hybrid/PBX Mode)

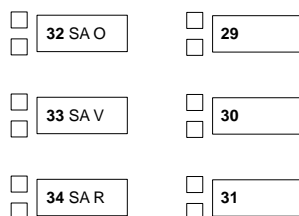

Figure G-11. ETR-6 Telephone (Hybrid/PBX Mode)

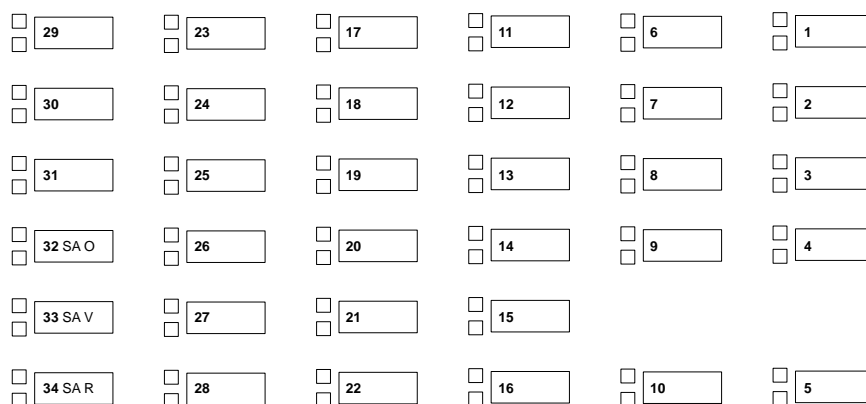

Figure G-12. MLS-34D Telephone (Hybrid/PBX Mode)

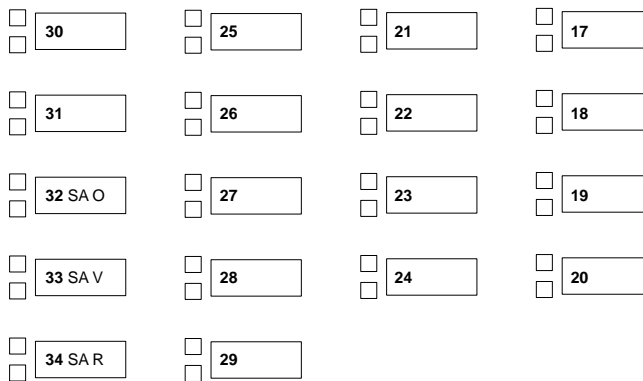

Figure G-13. MLS-18D Telephone (Hybrid/PBX Mode)

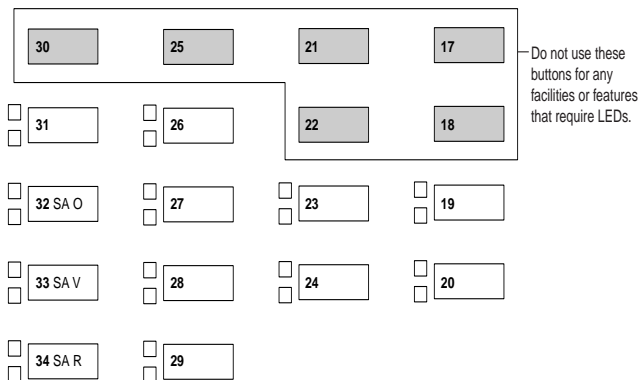

Figure G-14. MLS-12/12D, TransTalk, or Business Cordless 905 Telephone (Hybrid/PBX Mode)

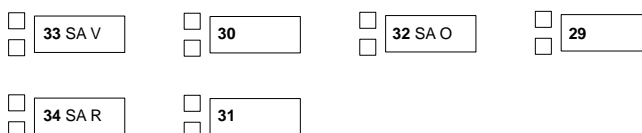

Figure G-15. MLS-6 Telephone (Hybrid/PBX Mode)

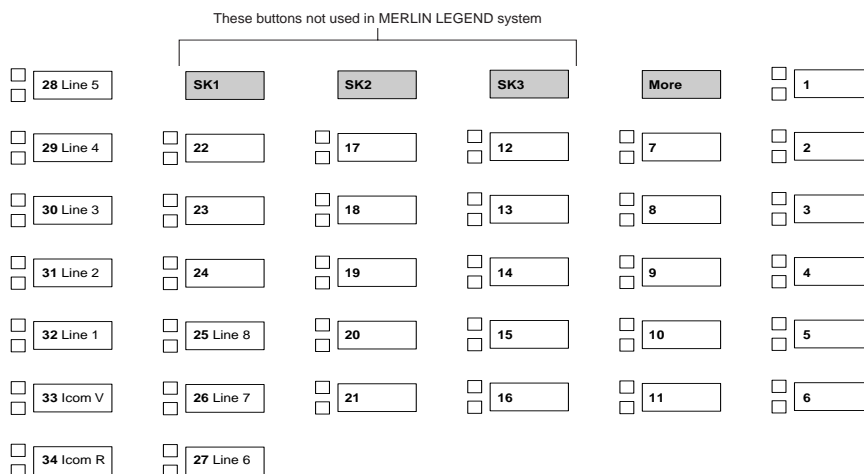

Figure G-16. ETR-34D Telephone (Key Mode)

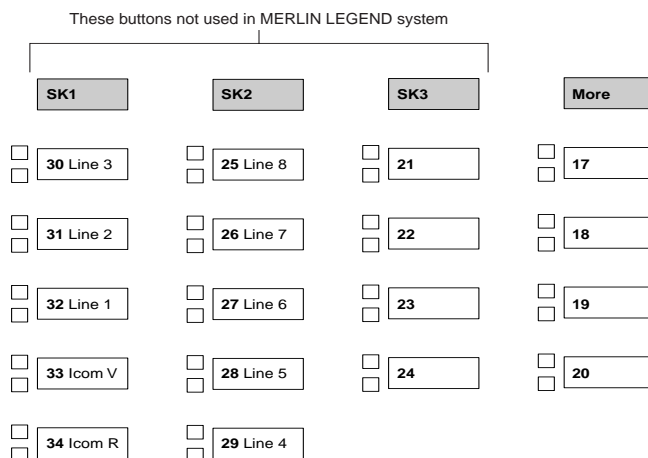

Figure G-17. ETR-18/18D Telephone (Key Mode)

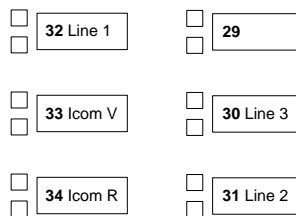

Figure G-18. ETR-6 Telephone (Key Mode)

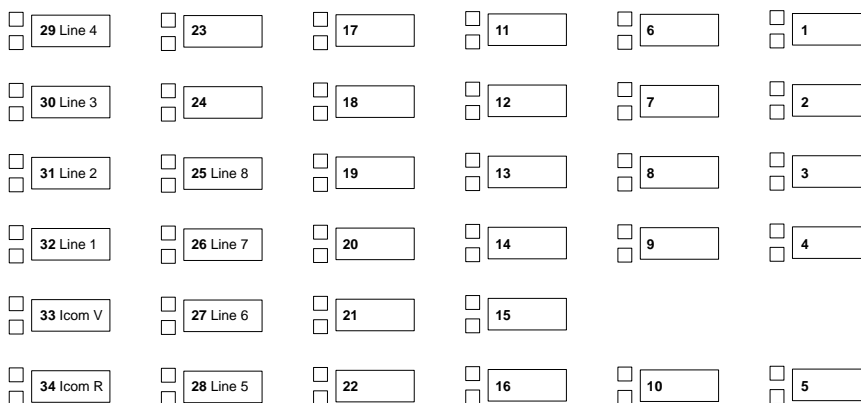

Figure G-19. MLS-34D Telephone (Key Mode)

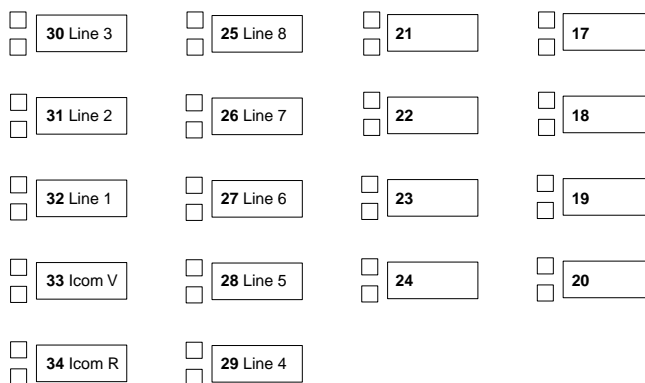

Figure G-20. MLS-18D Telephone (Key Mode)

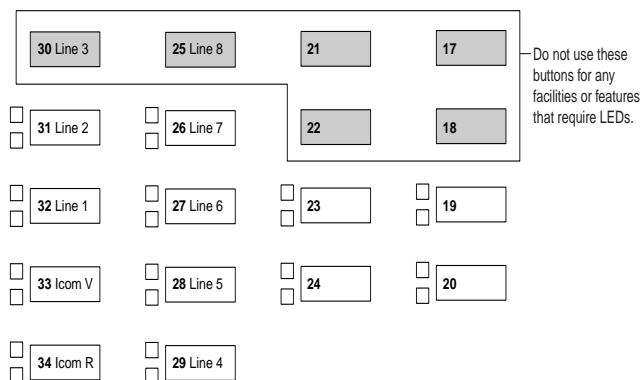

Figure G-21. MLS-12/12D, TransTalk, or Business Cordless 905 Telephone (Key Mode)

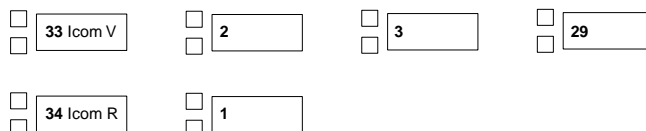

Figure G-22. MLS-6 Telephone (Key Mode)

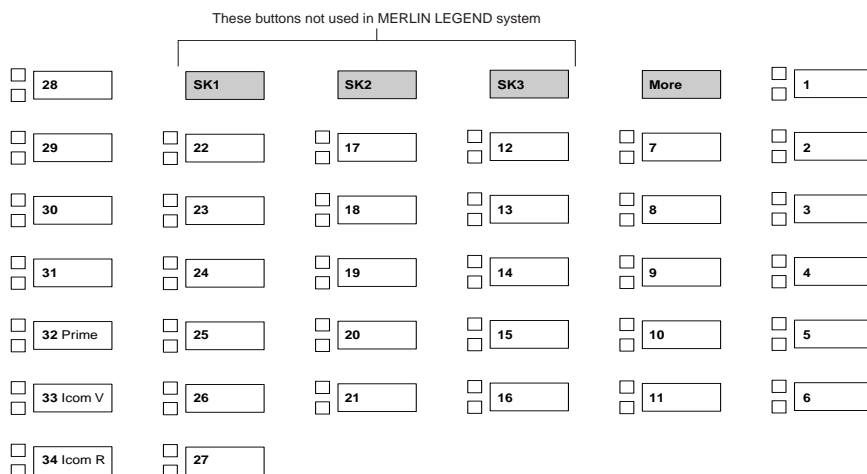

Figure G-23. ETR-34D Telephone (Behind Switch Mode)

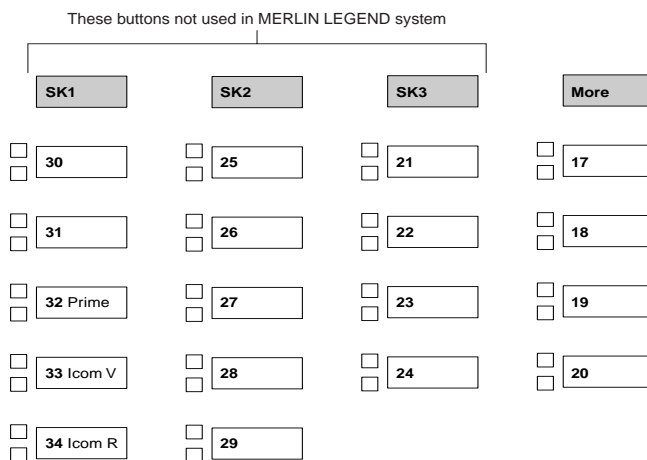

Figure G-24. ETR-18/18D Telephone (Behind Switch Mode)

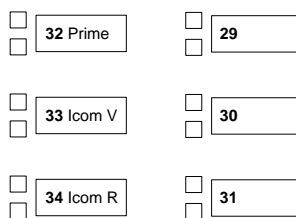

Figure G-25. ETR-6 Telephone (Behind Switch Mode)

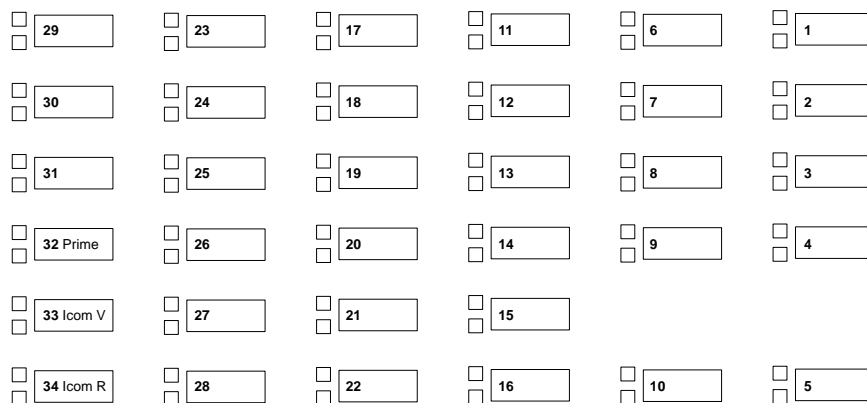

Figure G-26. MLS-34D Telephone (Behind Switch Mode)

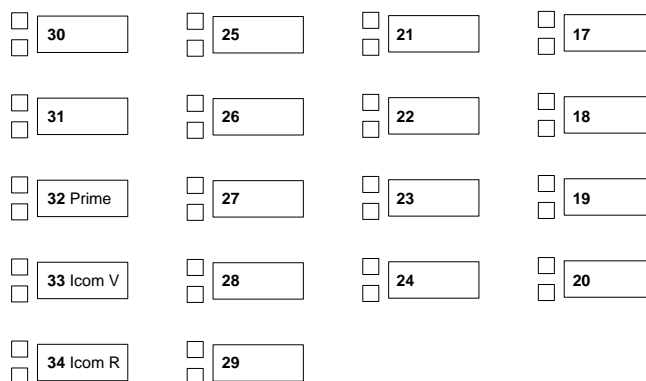

Figure G-27. MLS-18D Telephone (Behind Switch Mode)

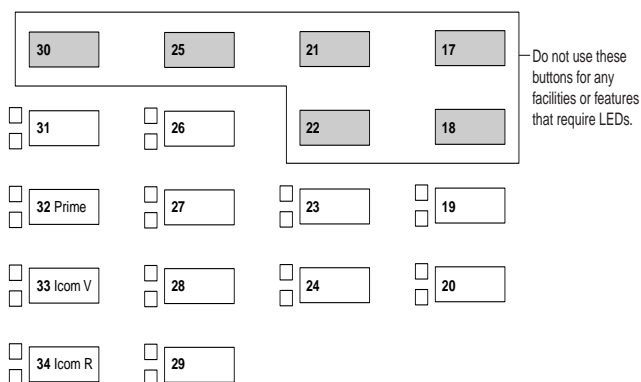

Figure G-28. MLS-12/12D, TransTalk, or Business Cordless 905 Telephone (Behind Switch Mode)

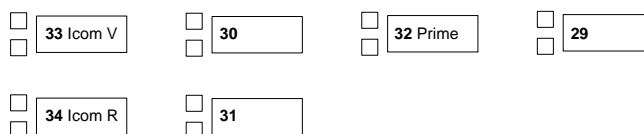

Figure G-29. MLS-6 Telephone (Behind Switch Mode)

Programming Special Characters



This appendix provides the special characters used in dialing sequences for numbers dialed automatically, such as on Auto Dial buttons. The characters allowed depend on the type of telephone.

Single-Line Telephones

Some dialing sequences need special characters. For example, the user presses and releases either the Recall or Flash button or the switchhook to insert a Pause character in a dialing sequence after a dial-out code to allow the system to seize an outside line/trunk before dialing the number.

Table H-1. Special Characters for Single-Line Telephones

Press...	Means...
Recall, Flash, or switchhook ¹	Pause. Inserts a 1.5-second pause in the dialing sequence. Multiple consecutive pauses are allowed.
#	End of Dialing. Used to signal the end of the dialing sequence or to separate one group of dialed digits from another, such as an account code from a telephone number.

¹ On single-line telephones with positive or timed disconnect (such as the 2500YMGL), the Recall or Flash button, instead of the switchhook, must be used.

Analog Multiline Telephones

Some dialing sequences need special characters—for example, the user presses Hold to insert a Pause character after the dial-out code in a dialing sequence to allow the system to seize an outside line before dialing the number. A Pause character can also be used to separate a telephone number from an extension number.

Table H-2. Special Characters for Analog Multiline Telephones

Press...	See ¹ ...	Means...
Drop ²	s	Stop. Inserts a Stop within a sequence of automatically dialed numbers—for example, an outside Auto Dial button may be programmed with a password, then a Stop, then a telephone number. To use Auto Dial with a Stop in the sequence, the user presses the button to dial the password, listens for the dialing and connection, and presses the button again to dial the number.
Hold	p	Pause. Inserts a 1.5-second pause in the dialing sequence. Multiple consecutive pauses are allowed.
Conference ²	f	Flash. Sends a switchhook flash. Must be the first entry in the dialing sequence.
##	#	End of Dialing for Auto Dial buttons. Used at the end of a dialing sequence to indicate that the user has finished dialing or to separate one group of dialed digits from another.
#	#	End of Dialing. Used at the end of a dialing sequence to indicate that the user has finished dialing or to separate one group of dialed digits from another.

1 Display telephones only.

2 Not available on MLC-5, MDC 9000, and MDW 9000 cordless and cordless/wireless telephones.

MLX-10 and MLX-5 Non-display Telephones

Some dialing sequences need special characters—for example, the user presses Hold to insert a Pause character after the dial-out code in a dialing sequence to allow the system to seize an outside line before dialing the number. A Pause character can also be used to separate a telephone number from an extension number.

Table H-3. Special Characters for MLX-10 and MLX-5 Non-display Telephones

Press...	Means...
Drop	Stop. Halts the dialing sequence to allow for system response.
Hold	Pause. Inserts a 1.5-second pause in the dialing sequence. Multiple consecutive pauses are allowed.
Conf	Flash. Sends a switchhook flash. Must be the first entry in the dialing sequence.
#	End of Dialing for extension programming only. Used at the end of a dialing sequence to indicate that the user has finished dialing or to separate one group of dialed digits from another.
##	End of Dialing. Used to signal the end of the dialing sequence or to separate one group of dialed digits from another.

MLX Display Telephones

Some dialing sequences need special characters—for example, the user presses Hold to insert a Pause character in a dialing sequence after a dial-out code to allow the system to seize an outside line before dialing the number. A Pause character can also be used to separate a telephone number from an extension number.

Table H-4. Special Characters for MLX Display Telephones

Press...	See...	Means...
Drop	s	Stop. Halts the dialing sequence to allow for system response.
Hold	p	Pause. Inserts a 1.5-second pause in the dialing sequence. Multiple consecutive pauses are allowed.
Conf	f	Flash. Sends a switchhook flash. Must be the first entry in the dialing sequence.
#	#	End of Dialing for extension programming only. Used at the end of a dialing sequence to indicate that the user has finished dialing or to separate one group of dialed digits from another.
##	#	End of Dialing. Used to signal the end of the dialing sequence or to separate one group of dialed digits from another.

ETR and MLS Non-display Telephones

Some dialing sequences need special characters—for example, the user presses Hold to insert a Pause character after the dial-out code in a dialing sequence to allow the system to seize an outside line before dialing the number. A Pause character can also be used to separate a telephone number from an extension number.

Table H-5. Special Characters for ETR and MLS Non-display Telephones

Press...	Means...
Drop ¹	Stop. Halts the dialing sequence to allow for system response.
Hold	Pause. Inserts a 1.5-second pause in the dialing sequence. Multiple consecutive pauses are allowed.
Conf	Flash. Sends a switchhook flash. Must be the first entry in the dialing sequence.
#	End of Dialing for extension programming only. Used at the end of a dialing sequence to indicate that the user has finished dialing or to separate one group of dialed digits from another.
##	End of Dialing. Used to signal the end of the dialing sequence or to separate one group of dialed digits from another.

¹ The Drop button must be programmed on ETR and MLS telephones.

ETR and MLS Display Telephones

Some dialing sequences need special characters—for example, the user presses Hold to insert a Pause character in a dialing sequence after a dial-out code to allow the system to seize an outside line before dialing the number. A Pause character can also be used to separate a telephone number from an extension number.

Table H-6. Special Characters for ETR and MLS Display Telephones

Press...	See...	Means...
Drop ¹	s	Stop. Halts the dialing sequence to allow for system response.
Hold	p	Pause. Inserts a 1.5-second pause in the dialing sequence. Multiple consecutive pauses are allowed.
Conf	f	Flash. Sends a switchhook flash. Must be the first entry in the dialing sequence.
#	#	End of Dialing for extension programming only. Used at the end of a dialing sequence to indicate that the user has finished dialing or to separate one group of dialed digits from another.
##	#	End of Dialing. Used to signal the end of the dialing sequence or to separate one group of dialed digits from another.

¹ The Drop button must be programmed on ETR and MLS telephones.

Applications



This appendix provides an *overview* of the applications that you can connect to the system or that were available in the past. For complete information about the use of any application discussed here, refer to the documentation for that product.

The system supports the following applications for enhanced call-handling and system management capabilities:

- [PassageWay Direct Connection Solution](#) (see [“PassageWay Direct Connection Solution” on page I-5](#)).
- Stand-alone voice messaging applications (see [“Voice Messaging Systems” on page I-6](#)).
- Stand-alone call accounting and management applications (see [“Call Accounting System” on page I-17](#) and [“Call Accounting Terminal” on page I-20](#)).



NOTE:

Call Management System (CMS) is no longer available for sale. However, a newer application, the MERLIN LEGEND Enhanced Service Center, provides similar capabilities. See [“MERLIN LEGEND Enhanced Service Center” on page I-16](#) for more information.

- Stand-alone telephone facilities and call-response management application for Windows (Release 4.2 and later systems only, see [“MERLIN LEGEND Reporter” on page I-23](#)).
- Stand-alone system management application: WinSPM and System Programming and Maintenance (SPM) for DOS (see [“System Programming and Maintenance” on page I-29](#)).

- Integrated applications:
 - Messaging 2000
 - Automated Attendant
 - Voice/Fax Mail
 - Intuity (see [page I-31](#))
 - AUDIX Voice Messaging
 - CAS
 - Fax Messaging
 - Internet Messaging
 - Message Manager
 - Inter Exchange Server
- Intuity CONVERSANT (see [page I-32](#)).
- Videoconferencing (see [page I-34](#)).
- Data communications device—ISDN Terminal Adapter

Organization of Descriptions

The following sections provide a brief description of each application, service, or system. Most descriptions include the subheadings below. When a subheading does not pertain to a given application, it does not appear.

- **Mode Differences.** Lists any differences or limitations of the application in Key, Hybrid/PBX, or Behind Switch modes of operation.
- **Considerations and Constraints.** Discusses restrictions, capacities, and other information that you should consider before installing or using the application.
- **Feature Interactions.** Provides information about system and telephone features that affect how the application works and notes any features that do not work with the application.
- **System Programming.** Provides an outline of the system programming required to set up the application.
- **Platform Requirements.** Lists the hardware and software required to connect the application to the system.

Also see *System Planning* for planning instructions, *System Programming* for complete system programming instructions, and the documentation provided with the application for connection diagrams and installation instructions.

System Support for Applications

[Table I-1](#) summarizes the system's capacity to support each application and identifies the modes of operation in which you can use the application.

Table I-1. Application Capacities and Modes of Operation

Application	Capacity	Key	Hybrid/ PBX	Behind Switch
PassageWay Direct Connection Solution	200 (MLX only)	✓	✓	✓
MERLIN Mail VMS R3 ¹ Number of mailboxes	1 (2, 4, or 6 jacks) ² 100	✓	✓	
MERLIN LEGEND Mail VMS Number of mailboxes	1 (2, 4, or 6 jacks) ² 100	✓	✓	
MERLIN LEGEND Reporter	1		✓	
Messaging 2000 Number of mailboxes	1000	✓	✓	
Lucent Technologies Attendant ¹	4 ²	✓	✓	
CAS Plus V3/CAS for Windows	1	✓	✓	✓
CAT	1	✓	3	✓
CMS ¹ Number of lines/trunks (each)	2 28	✓	✓	
Number of agents (each)	28			
Number of external alerts (each)	4			
SPM (stand-alone UNIX or DOS)	1	✓	✓	✓
WinSPM	1	✓	✓	✓
IS II ¹ AUDIX Voice Power	1 1	✓ ✓	✓ ✓	
Number of mailboxes	300			
Automated Attendant	1	✓	✓	
IS CAS	1	✓	✓	
SPM	1	✓	✓	
IS III ¹ AUDIX Voice Power	1 1	✓ ✓	✓ ✓	
Number of mailboxes	300			
Automated Attendant				
CAS IS III	1	✓	✓	
SPM	1	✓	✓	
Fax Attendant	1	✓	✓	

Table I-1. Application Capacities and Modes of Operation — Continued

Application	Capacity	Key	Hybrid/ PBX	Behind Switch
Intuity	1	✓	✓	
AUDIX	1	✓	✓	
Number of mailboxes	300			
Fax Messaging	1	✓	✓	
ICAS	1	✓	✓	
SPM	1	✓	✓	
MERLIN LEGEND Enhanced Service Center		✓	✓	✓
Number of active agents	25			
Videoconferencing			✓	
Intuity CONVERSANT	1	✓	✓	

1 These applications are no longer available for purchase.

2 These attendant applications are mutually exclusive. MERLIN LEGEND Mail includes a jack in addition to those listed; it is used for the application's modem. Although MERLIN Mail and MERLIN LEGEND Mail can support up to 100 mailboxes; 60 are recommended.

Supported Printers

The following table shows the printers that are supported with the optional applications discussed in this chapter. For many applications, a comparable printer can be used, rather than the specific product listed below.

Table I-2. Applications Printers

Printer	Document No.	Description
Lucent Technologies CAS Printer	582-421-105	9-pin dot matrix printer that provides choice of print quality and speed. Uses parallel connection to the computer.
Lucent Technologies Applications Printer	582-421-106	9-pin dot matrix printer that provides choice of print quality and speed. Has wide carriage that accommodates pin-feed paper up to 14 7/8 in. (37.8 cm) wide. Uses parallel connection to the computer.
Call Accounting Terminal (CAT) Printer	582-421-100	9-pin dot matrix printer that provides choice of print quality and speed. Uses serial connection to the computer.

PassageWay Direct Connection Solution

IMPORTANT:

This section is intended solely as an overview of the application. For comprehensive information about the use of the application, see the documentation for the product.



NOTE:

This entry describes PassageWay Direct Connection Solution Release 2. This version must be used with MERLIN LEGEND Communications System Release 3.0 and later. PassageWay Direct Connection Solution Release 1.0 can be used with MERLIN LEGEND Communications Systems Release 2.1.

PassageWay Direct Connection Solution is a collection of software applications and a hardware adapter. It provides an API (applications programming interface) link between a PC with Windows 3.1 or later and the MERLIN LEGEND Communications System through an MLX-28D, MLX-20L, MLX-16DP, or MLX-10DP telephone.

PassageWay Direct Connection Solution includes these applications:

- **Call.** A cardfile application that enables you to maintain information such as names, addresses, and telephone numbers. You specify the information that you want to store. With Call, you can place a call directly from the PC and keep a log of all outgoing calls.
- **Set.** A telephone programming application that enables you to program telephone features for your telephone from your PC. You can also create and save multiple-button programming files for your telephone and can exchange these files with other Set users.
- **Log Viewer.** An application that enables you to view the entries stored in the PassageWay Direct Connection Solution call log. The call log stores a record of every call you make using Call.
- **Connect.** Management software that provides both the basis for other PassageWay Direct Connection Solution software applications and the diagnostic features to troubleshoot these applications. Auto dialing capabilities using the Hayes-compatible command set are also provided.
- **Buzz.** You can manage incoming calls (answer, hold, or drop) and view the calling party number (Caller ID) for each incoming call at your telephone.

Considerations and Constraints

If there are problems connecting PassageWay Direct Connection Solution to a communications port, see the PassageWay Direct Connection Solution manual for information on PC serial ports.

In Release 6.0 and later systems, if you are using PassageWay Direct Connect Solution, see the *Network Reference* for complete details.

Feature Interactions

Idle Line Preference Your MLX telephone should have Idle Line Preference activated. With Idle Line Preference activated, the system automatically selects a line for outgoing calls when you go off hook.

The system manager should set Automatic Line Selection on your telephone so that your Idle Line Preference is on an ICOM button (in Key or Behind Switch mode) or an SA button (in Hybrid/PBX mode). Ensuring that Automatic Line Selection is set to an ICOM or an SA button means you can make both inside and outside calls via Lucent Technologies Call. (You make outside calls on an ICOM or SA button by dialing 9.)

Voice Messaging Systems

IMPORTANT:

This section is intended solely as an overview of the applications. For comprehensive information about the use of the applications, see the documentation for the products.



SECURITY ALERT:

Your voice messaging system permits callers to leave verbal messages for system users or gain access to the backup position in an emergency as well as create and distribute voice messages among system users.

The voice messaging system, through proper programming, can help you reduce the risk of unauthorized persons gaining access to the network. However, telephone numbers and authorization codes can be compromised when overheard in a public location or are lost either through theft of a wallet or purse containing access information or through carelessness (writing codes on a piece of paper and improperly discarding them). Additionally, hackers may use a computer to dial an access code and then publish the information to other hackers. Substantial charges can accumulate quickly. It is your responsibility to take appropriate steps to

implement the features properly, evaluate and program the various restriction levels, protect and carefully distribute access codes.

Under applicable tariffs, you are responsible for payment of toll charges. Lucent Technologies cannot be responsible for such charges and will not make any allowance or give any credit resulting from unauthorized access.

To reduce the risk of unauthorized access through your voice messaging system, please observe the following procedures:

- *Employees who have voice mailboxes should be required to use passwords to protect their mailboxes.*
- *The administrator should remove any unneeded voice mailboxes from the system immediately.*
- *MERLIN LEGEND Mail and Intuity AUDIX have the ability to limit transfers to subscribers only. You are strongly urged to limit transfers in this manner.*
- *Monitor SMDR reports or Call Accounting System reports for outgoing calls that might be originated by voice messaging ports.*

A voice messaging system (VMS) provides call-answering services and may provide voice mail services. Each of the following VMS applications connects to an enhanced T/R port, called a *voice messaging interface (VMI) port*:

- MERLIN Mail Voice Messaging System (no longer available)
- MERLIN LEGEND Mail Voice Messaging System (supplies its own ports with its own module)
- Messaging 2000
- MERLIN LEGEND Enhanced Service Center
- Lucent Technologies Attendant (no longer available)
- AUDIX Voice Power (no longer available)
- Intuity AUDIX



SECURITY ALERT:

Beginning with Release 2.1, an 012 (T/R) or 016 (T/R) port that is programmed as a generic VMI port can transfer an outside call to an outside number. Previously, only VMI ports programmed as integrated VMI ports could do a trunk-to-trunk transfer. A single-line telephone connected to an integrated VMI port can complete trunk-to-trunk transfers. In Release 3.1 and later systems, the default setting disables trunk-to-trunk transfers from these ports.

Calling restrictions (for example, Disallowed Lists, Toll Restriction, Facility Restriction Levels) should be programmed, as appropriate, to minimize toll fraud abuse, especially if a single-line telephone is connected to an integrated VMI port. Refer to this guide for additional information on programming calling restrictions.

Beginning in Release 6.1, a MERLIN LEGEND System without a VMS can share the VMS on another MERLIN LEGEND System Release 6.1, provided that the systems are in Hybrid/PBX mode and are connected directly by PRI tandem trunks or analog/digital tie trunks. This sharing of the VMS is called "Centralized Voice Messaging" and is supported for the following voice messaging systems:

- MERLIN LEGEND Mail
- Messaging 2000
- Intuity AUDIX
- IS III AUDIX Voice Power (no longer available)

A VMS requires touch-tone receivers (TTRs); the number it requires depends on the number of VMI ports. See ["Touch-Tone or Rotary Signaling" on page 716](#).

Voice Messaging Interface (VMI) Port Capabilities

VMI ports use switchhook flashes for Hold, Transfer, Conference, and Drop in the same way single-line telephones do. VMI ports also have the ability to perform transfer redirection, to respond to far-end disconnect, and, in the case of integrated VMI ports only, to send call information and mark a port in or out of service. The following sections describe these capabilities. Beginning with Release 2.1, both integrated and generic VMI ports can perform trunk-to-trunk transfer.



NOTE:

An 016 (T/R) module can ring all 16 ports simultaneously. On an 012 (T/R) or MERLIN LEGEND Mail module, only four ports can ring simultaneously (sufficient for the 6-port configuration of the MERLIN LEGEND Mail module). If you are using an attendant or voice messaging system that requires eight of the 012 (T/R) jacks on a single module, you should not use the remaining jacks on the module. If the application uses fewer than 8 jacks, you may use the remaining jacks for T/R devices such as single-line telephones.

Transfer Redirect

If unanswered by the end of the transfer redirect time interval (0–9 rings), a call transferred from a VMI port alerts at the VMS transfer redirect extension, rather than returning to the VMI port that originated the transfer. For example, you might program Extension 15 as a VMI port for a Lucent Technologies Attendant and set the transfer redirect time interval to four rings. When a call comes in on Extension 15, the caller listens to a recording and dials a request for Extension 24. The call rings at Extension 24 four times without being answered. The system redirects the call to Extension 10, the system operator; it does not redirect the call back to Extension 15.



NOTE:

Beginning in Release 6.1, a call transferred to a non-local extension has a transfer redirect time interval set at 32 seconds, instead of a programmable number of rings.

On an unsupervised transfer (described in [“Automated Attendant Service” on page I-10](#)), when the transfer destination is busy or is an invalid extension, the transfer redirect is immediate (no time interval). If the system cannot alert the transfer redirect extension (all buttons are in use), the VMS keeps trying to alert the transfer redirect extension every 20 seconds until the alert is delivered or the caller hangs up.

Far-End Disconnect

When the system detects a far-end disconnect signal on a line/trunk where a VMI extension is receiving a call, the system sends the disconnect signal to the VMI extension, whether or not that extension is the only party left on the call. If another party is still on the call, the VMS decides whether to continue or disconnect the party. (The far-end disconnect signal occurs only if you program the VMI port for Reliable Disconnect.) Loop-start lines must be programmed for Reliable Disconnect.

Ports In/Out of Service

When a group call to a VMI extension is not answered within 30 seconds, the call either is sent to another available VMI extension in the calling group or is queued back to wait for an available extension in the calling group.

For an integrated VMI extension, the control unit sends messages to inform the VMS that the extension is out of service. Both the VMS and the calling group software mark the unavailable port as out of service. If all VMI extensions go out of service, the system generates a hardware error report.

Every 10 minutes, the system tests each out-of-service VMI extension. If the extension responds to the test, the VMS and the calling group software mark it as *in service*. For an integrated VMI extension, the control unit informs the VMS by sending extension-in-service messages.

MERLIN LEGEND Mail

IMPORTANT:

This section is intended solely as an overview of the application. For comprehensive information about the use of the application, see the documentation for the product.

The MERLIN LEGEND Mail Voice Messaging System (VMS) is a stand-alone application that provides the following integrated call-handling services:

- Automated Attendant Service
- Call Answer Service
- Voice Mail Service

The MERLIN LEGEND Mail VMS supplies the same functionality as MERLIN Mail VMS Release 3.0. However, it is packaged as a single, integrated module that plugs into the backplane of the MERLIN LEGEND Communications System control unit. The module resembles an 012 (T/R) module; it replaces the hardware required to support MERLIN Mail Release 3.0. The standard configuration includes two VMI ports, expandable to a total of 6 ports. In addition, the MERLIN LEGEND Mail VMS includes an internal Remote Maintenance Device (RMD) for answering remote maintenance calls, a serial port for connecting a PC to the module, and a detachable disk drive for storing messages.

Automated Attendant Service

Automated Attendant Service consists of one or more menus, providing callers with a number of options that allow them to quickly access an extension, a department, or information by pressing a single dialpad button. In MERLIN LEGEND Mail, there can be up to three Automated Attendants.

This service provides several major benefits, both to the callers and to the company:

- Different greetings, menus, and announcements can be recorded to play during the day and night.

For example, during the day you may want to tell callers to stay on the line for assistance by an operator. At night, when there may be no operator, you may want to tell callers to stay on the line to leave a message in the Automated Attendant General Mailbox.

- Different greetings, menus, and announcements can be recorded to play for different incoming lines.

For example, you may want to answer calls using one corporate name on one set of telephone numbers and answer calls using another name on a different set of telephone numbers.

- Calls are routed efficiently to the correct party.
- Incoming fax calls from machines that produce industry-standard fax (CNG) tones are recognized and automatically routed to the fax extension.
- Using the Automated Attendant Touch-Tone Gate feature, callers on rotary telephones or needing assistance are either automatically transferred to the system operator or Automated Attendant General Mailbox or disconnected, based on your company's preference.
- If callers do not know the extension needed, they can either access a directory of subscribers or be transferred automatically to an operator.
- Announcements of frequently requested information—such as directions or business hours—can be included as menu options, freeing an employee's time for other tasks.
- Callers can be given the choice of two languages in which to hear prompts. These languages may be American English and Canadian French or American English and Latin-American Spanish.
- You can set up the system to answer calls immediately or after a delay. If the system is set for delayed call handling, calls unanswered by the system operator are answered by an Automated Attendant after a specified number of rings.

Call Answer Service

The system's Call Answer Service allows callers to leave messages or to transfer to another extension when the extension called is busy or does not answer. When a message is left, Call Answer Service deposits the message in the subscriber's voice mailbox, then lights the message-waiting indicator on the subscriber's telephone. If the subscriber has Outcalling turned on, the system also places a call to up to five specified Outcalling numbers.

Bulletin Board mailboxes can be created to contain timely information, such as current teaching assignments from teachers or professors.

Guest mailboxes can be created for users who do not have their own extensions, such as temporary workers, contract workers, and consultants. They can receive messages from subscribers and outside callers, even if they do not have an actual extension in the system.

In addition to acting as an answering machine, Call Answer enables callers to perform any of the following actions:

- Press 0 for the subscriber's personal operator or the system operator.
- Transfer to another extension by dialing *T (or *8) before or after leaving a message.
- Review and edit messages before depositing them in the voice mailbox.

Voice Mail Service

Voice Mail Service lets subscribers do the following:

- Listen to messages from nonsubscribers and other subscribers.
- Record their own personal greetings and names.
- Forward a received message to one or more subscribers, with additional comments, if desired.
- Assign their own passwords, which they can change to ensure that messages are kept confidential.
- Create a message and send it to one or more subscribers.
- Choose an extension to be a personal operator that receives calls when a caller dials 0 after reaching the subscriber's mailbox.
- Designate up to five telephone numbers and/or pager/beepers that are notified when a new message arrives in the subscriber's mailbox.

Mode Differences

The system must operate in Key or Hybrid/PBX mode. You cannot connect MERLIN LEGEND Mail to a system operating in Behind Switch mode.

Considerations and Constraints

The MERLIN LEGEND Mail VMS is available in 2-port, 4-port, and 6-port configurations. The 2-port and 4-port configurations have 6 hours of message storage capacity, and the 6-port configuration has 10 hours of message storage capacity.

The size of a subscriber's mailbox—that is, the total amount of storage for all the messages it can hold—is variable. Available options are 5, 10, or 15 minutes; 5-, 10-, or 60-minute *total* storage is available for mailboxes.

Callers with rotary telephones whose calls are answered by the Automated Attendant Touch-Tone Gate cannot use the features of the MERLIN LEGEND Mail VMS. The application should be set up to direct these calls to the system operator during business hours.

Each Automated Attendant answers calls immediately (immediate call handling) or after a delay (delayed call handling).

You program the VMS with a touch-tone telephone. To support remote diagnostics, the MERLIN LEGEND Mail VMS is equipped with a 9-pin RS-232 serial port and a 1,200-baud internal remote maintenance device.

You should assign Disallowed Lists to the VMI ports that connect to MERLIN LEGEND Mail voice messaging systems. Restrict or toll-restrict the VMI ports and then assign Allowed Lists as necessary. This prevents toll calls from being dialed through the VMS and permits the application to call out only to the area codes or numbers you specify. If Automatic Route Selection is being used, apply the appropriate Facility Restriction Levels. See the documentation that comes with the product for more details.

You cannot use MERLIN LEGEND Mail VMS with Lucent Technologies Attendant.

Feature Interactions

Centralized Voice Messaging

Centralized Voice Messaging can be used with MERLIN LEGEND Mail.

Coverage

Use system programming to assign all extensions that need coverage to a coverage group. The system does not do this automatically. It assigns the VMS ports to a calling group and designates the VMS as the coverage receiver for the coverage group.

Subscribers can program their telephones so that only outside calls are sent to coverage.

In Release 2.0 and later, when subscribers activate Coverage VMS Off for their telephones, normally covered outside calls are not covered. No special programming is needed on MERLIN LEGEND Mail to activate this feature.

Group Calling

Use system programming to assign the MERLIN LEGEND Mail VMI ports to the same calling group.

With integrated VMI ports, mode codes identify coverage calls that overflow from one calling group to another calling group. As a result, the overflow calling group's number appears in the Called Party field of the mode code.

Leave Message

If the target telephone does not have display capabilities, the Leave Message feature sends mode codes to the MERLIN LEGEND Mail VMS to deposit a message.

In Release 2.0 and later, when the MERLIN LEGEND Mail VMS sends a Leave Message notification to an extension, the system identifies the VMS calling group as the sender of the message. As a result, when a subscriber uses the Return Call feature, the call goes to any available VMS port, not just to the port that generated the message. This reduces the chance of getting a busy port.

Night Service

Each MERLIN LEGEND Mail VMS Automated Attendant can work with the Night Service feature to provide specialized after-hours service. An Automated Attendant can answer calls on lines it does not handle during business hours. A special night announcement can greet after-hours callers.

Privacy

Privacy is automatic for all VMI ports.

Ring Options

If lines set for answering by an Automated Attendant appear on telephones other than the system operator console or backup extension, program them for No Ring.

SMDR

In Release 4.2 and later systems, if an automated attendant or voice response unit transfers an outside call to an Auto Logout or Auto Logout calling group and the Talk Time option is enabled, a call record is created in the same way that it is for other incoming calls to this type of group.

Transfer

If a call received on a line/trunk is transferred to a VMI port, the direct inside access mode code is sent. The call is treated as a transferred call, and the caller hears the greeting assigned for callers within the system.

You can program any calling group, calling group member, or extension as a VMS transfer redirect extension. If the extension is a QCC, the VMS forwards the transfer redirect call to the QCC as a returning call and places it in the QCC queue.

If a transferred caller gets no answer and returns to the system operator, the operator has no indication of the origin of the call.

Required Voice Messaging Interface (VMI) Ports

The number of required VMI ports depends on the number of incoming lines/trunks, the number of subscribers programmed for Automated Attendant service, and the number of busy-hour calls. [Table I-3](#) lists these requirements.

Table I-3. Ports Required for MERLIN LEGEND Mail Voice Messaging Systems

No. of VMI Ports Required	Incoming Lines/Trunks	No. of Subscribers or Busy-Hour Calls
2	1 to 6	1 to 20
4	7 to 18	21 to 60
6	19 and up	61 and up

Messaging 2000

Messaging 2000 is a voice messaging system that consists of a stand-alone PC containing ports for voice and fax mail. The system offers flexibility for the small- and mid-sized business, ranging from 4 to 16 voice-processing ports and 2 to 4 fax-processing ports. A total storage capacity of 60 hours is provided.

The voice messaging capabilities include:

- Automated Attendant
- Call handling
- Voice mail
- Fax mail
- Windows-based graphic user interface of a user's voice mail (optional)

Messaging 2000 requires the following components:

- Messaging 2000 standard system, consisting of a PC with a CD-rom drive, monitor, keyboard, mouse, and one 4-port voice-processing circuit board
- MERLIN LEGEND Communications System of Release 5.0 or later
- 016 (T/R) or 012 (T/R) module

Up to three additional circuit boards with voice-processing ports or fax-processing ports may be added to the Messaging 2000 system. Each voice-processing circuit board contains four ports, and each fax-processing circuit board contains two ports.

The voice and fax ports on the Messaging 2000 system connect to ports on 016 (T/R) and 012 (T/R) modules.

Automated Attendant

The Automated Attendant feature of Messaging 2000 allows customers to answer all calls or only those calls the live operator cannot take (such as after-hours calls).

Voice Mail

The Messaging 2000 provides up to 1000 mailboxes. Each mailbox can have up to 1000 messages.

Fax Mail

Faxes can be received by the Messaging 2000 system and sent out to any fax machine. Users can obtain stored faxes from any location with just a telephone and a fax machine.

MERLIN LEGEND Enhanced Service Center

Typically used in a customer service environment, the MERLIN LEGEND Enhanced Service Center (ESC) provides the automatic answering, distribution, and placing in queue of customer calls. The unit itself is a mini-tower PC and comes in 12-port and 18-port configurations.

The components needed to operate the ESC include:

- MERLIN LEGEND Enhanced Service Center package (12 or 18 ports)
 - Includes CONVERSANT MAP 5P software
 - Includes PassageWay Direct Connect connector
- MERLIN LEGEND Communications System of Release 5.0 or later
- A minimum of 8 TTRs; two 016 (T/R) modules are recommended for the 18-port ESC, and one 016 (T/R) module and one 400 GS/LS module are recommended for the 12-port ESC
- Dedicated MLX-28D telephone
- Windows 3.1 or Windows 95 for an optional ESC remote terminal monitor
- Optional wallboard

How the Enhanced Service Center Works

When a call comes into the customer service group, the ESC answers the call. The software searches for the available agent who has been waiting the longest time and sends the call to that agent. If no agent is available, the call is placed in queue and an announcement is played.

While a call is in queue, it uses one of the ports on the ESC. Once the call goes to an available agent, the port is freed.

Multiple announcements can be played. For example, the first announcement may tell the caller the approximate wait time and then give the caller a variety of options, including leaving a voice message or transferring to another extension. If the caller chooses to wait in the queue, subsequent announcements can provide information, promote products or services, or simply play music.

Release 2.0 of the Enhanced Service Center supports collected digits. The ESC can prompt the caller to enter an account number or some form of identifying digits. When the communications system is connected to a LAN server and the agents have the proper CTI link application in place, account information in the form of a screen pop can be provided along with the call.

The Enhanced Service Center allows up to four supervisors to monitor the activity of agents. Supervisors can make real-time changes to agents and queues.

The ESC provides real-time reports on the system's monitor, as well as on-demand reports that show agent information similar to a Call Management System report.

Optional wallboards can be connected to the ESC. These wallboards can display information such as the number of customers in queue, the number of available agents, and the average wait time for a call.

Call Accounting System

IMPORTANT:

This section is intended solely as an overview of the application. For comprehensive information about the use of the application, see the documentation for the product.

A Call Accounting System (CAS) is a software application for businesses that need to manage telephone usage and control costs by tracking, sorting, and recovering telephone charges. CAS provides a menu-driven user interface and online help.

The versions of CAS are:

- **CAS Plus V3.** This version, for general business use, is a stand-alone application that runs on a Lucent Technologies-approved DOS PC.
- **CAS for Windows.** This version takes advantage of the easy-to-use graphical user interface of Microsoft Windows. It is also a stand-alone application that runs on a Lucent Technologies-approved DOS PC. It allows a single CAS system to be used for both local and remote business sites.

Both versions allow businesses to calculate the costs of calls using the rates charged by long-distance carriers in one of 11 major metropolitan areas. In addition, you can customize CAS for Windows and CAS Plus V3 by programming additional rate tables.

Both versions provide the following services and features:

- **Call Record Processing.** This feature collects, stores, and produces records of calls, calculating costs using the selected rate table. You can program the system to process all calls or only calls that exceed a specified cost threshold. It can also add a service charge to calls before billing them to clients, departments, or projects.
- **Report Generation.** This feature organizes and prints call record information in the following formats:
 - **System Management.** The system manager can customize and maintain CAS activities by editing tables, setting up reports, and updating call rate information.
 - **Directory Lookup and Message Center.** Callers can look up anyone in the organization by name or extension, leave a message, and print or display messages.
- **HackerTracker System for CAS Plus V3.** Telephone systems with auto attendant, voice mail, or remote access lines are common targets for toll theft. HackerTracker is designed to help detect fraudulent use of the system by detecting abnormal calling activity and tracking authorization code usage.

CAS Plus V3



NOTE:

If your organization has PRI, BRI, or ICLID (loop-start with Caller ID service) lines/trunks, the system manager or programmer must create a customized facility name in the telephone system configuration in order to

distinguish among the three types of calls. If this is not programmed, all three types of calls are costed and reported as ANI/ANIAB calls.

Follow these steps to implement Caller ID information and CAS Plus V3 on Release 3.0 and later MERLIN LEGEND Communications Systems:

1. Program the Release 3.0 and later options, SMDR format for ISDN and SMDR call report for In/Out collection.
2. Install a new PBX/KTS interface, MERLIN LEGEND Communications System ISDN interface for the CAS Plus V3. To complete this task, you must have the PBX/KTS interface disk.
3. If necessary, update facility tables for the new ICLID line numbers under Telephone System Configuration in CAS. If your company has ISDN facilities, see the note that precedes these steps.
4. Program the dialed-digit processing (DDP) in CAS Plus V3 to identify the Caller ID calls that are completed (ANI) and those that are abandoned (ANIAB). Program the DDP records based upon how you want the calls to be displayed on CAS reports.
5. If your system is using MERLIN LEGEND Reporter, make sure that the SMDR Talk Time option is disabled.
6. Run a report to verify that Caller ID information is being processed and reported in CAS according to your needs and requirements.

Considerations and Constraints

You can connect only one CAS device to the system.

The system does not provide Station Message Detail Recording (SMDR) for calls within the system.

The number of calls about which CAS can store information depends on the amount of available disk space. In its largest configuration, CAS records data for up to 5,000 extensions and 15,000 account codes.

MERLIN LEGEND Reporter and Call Accounting System (CAS) should not be active on the system at the same time. Use MERLIN LEGEND Reporter when you primarily need to assess facilities and agent performance. CAS is used for costing purposes.

Feature Interactions

Account Code Entry	CAS uses the account codes, entered by users before or during calls, to provide reports by account code.
SMDR	CAS collects call information from the SMDR output of the system. To collect Caller ID or ANI information, program SMDR to ISDN format.

Call Accounting Terminal

IMPORTANT:

This section is intended solely as an overview of the application. For comprehensive information about the use of the application, see the documentation for the product.

A Call Accounting Terminal (CAT) is a dedicated terminal and printer designed to track, sort, and print reports on telephone charges. See Figures [I-1](#) and [I-2](#).

Three versions of CAT are available:

- **CAT Basic.** This version is an entry-level system for small businesses.
- **CAT Plus.** This version is for larger businesses and includes a two-line display.
- **CAT Plus/Hospitality.** This version, for hotels and health care facilities, also includes a two-line display.

You can set up a CAT to calculate the cost of calls using toll rates or by-the-minute charges. The CAT can apply service charges and discounts to calls made to local and long-distance numbers and to directory assistance. It can also identify calls to specified area codes (such as 900) for special treatment.

You customize CAT with current local and long-distance rates for your company's location. As rates change or a new area code or exchange is added, you can update the rate information by exchanging a chip inside the terminal. When you add a new telephone line or account code to the system, the CAT automatically adds the information to its memory the first time the new line or code is used.

CAT provides a variety of reports that it can print on a regular schedule or automatically when call information reaches 90 percent of the terminal's storage capacity. The available reports include the following, depending on the version of CAT that you have:

- A variety of summary and detail reports. For example, CAT can print reports on all extensions or rooms, a single extension or room, account codes, time of day, duration, and line/trunk facility.
- Management analyses organize call information by time of day, cost and duration of calls, area codes and exchanges called, and line/trunk facilities.

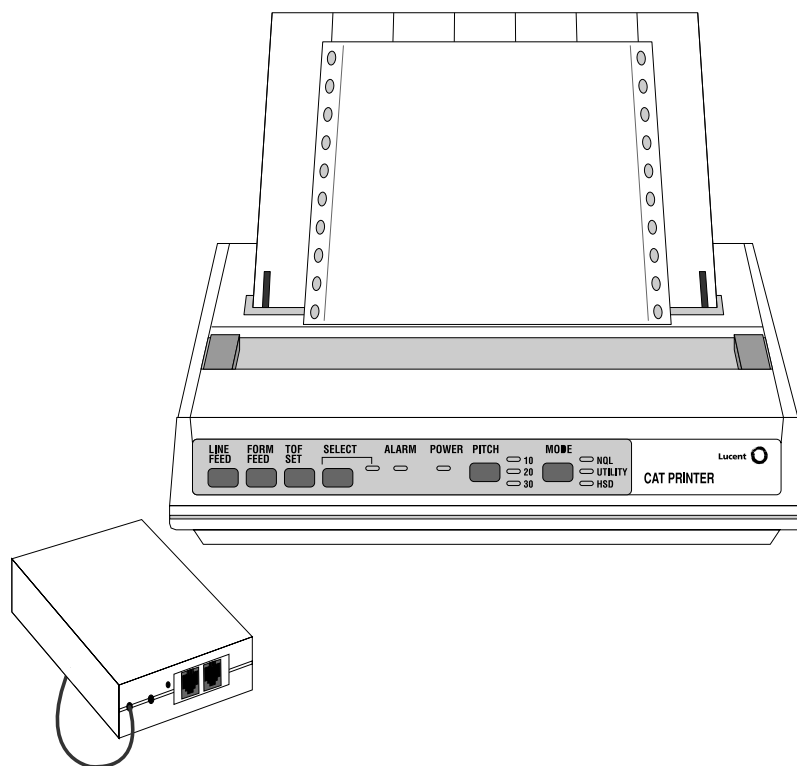

Figure I-1. Call Accounting Terminal Basic

CAT can receive and process ANI information as well as Caller ID information provided by the incoming line identification from SMDR. The system gets such information from the AT&T Megacom 800 service, MCI or central office (DMS-100) PRI services (Release 4.2 and later systems only), or local telephone company loop-start line/trunk Caller ID services and puts it into the SMDR.

CAT Plus features an LCD display.



NOTE:

The availability of caller identification information may be limited by local-serving (caller's) jurisdiction, availability, or telephone company equipment.

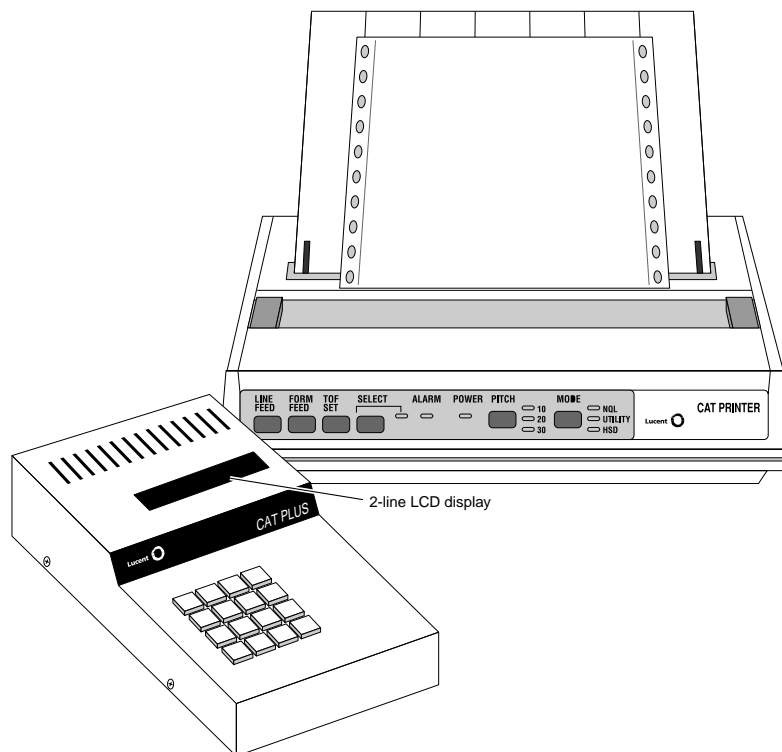

Figure I-2. Call Accounting Terminal Plus

Considerations and Constraints

You can connect only one CAT to the system.

CAT Basic can store information about as many as 1,200 calls for 100 extensions and 49 lines.

CAT Plus/Business can store information about as many as 6,500 calls made from up to 200 telephones that share up to 49 lines. When 90 percent of this capacity is reached and 5,850 of these calls have been processed, reports are printed and memory is cleared. Any calls that come in during this process are held until reports are printed again.

System Programming

Set SMDR options as follows:

- Select Basic or ISDN call report format. Select ISDN if you want ANI or Caller ID information reported.
- Specify the minimum call length to be recorded (10 seconds is recommended).
- Specify whether information is to be recorded for both incoming and outgoing calls or for only outgoing calls.

Feature Interactions

Account Code Entry CAT uses the 9-digit account codes that callers enter before or during calls to associate calls with accounts and individuals; these codes appear on CAT reports.

SMDR CAT collects call information from the SMDR output of the system.

MERLIN LEGEND Reporter

IMPORTANT:

This section is intended solely as an overview of the application. For comprehensive information about the use of the application, see the documentation for the product.

Available for Hybrid/PBX mode in Release 4.2 and later systems, MERLIN LEGEND Reporter helps system managers and calling group supervisors assess

the effectiveness of facilities and calling groups in responding to customer or client needs. It offers these broad benefits:

- **Monitoring of Facilities Volume Usage.** Traffic reports help in the analysis of peak-hour facilities usage and availability of calling group agents to respond to customer calls. The reports help determine whether availability issues can be resolved through staffing or additional facilities.
- **Customer Response Assessments.** Calling group managers can determine whether customers are hanging up rather than waiting for an available agent, how long they waited, and (with caller identification services) their telephone numbers so that agents can return their calls.
- **Monitoring Proper Facilities Usage.** Some facilities may be overutilized while others are ignored. MERLIN LEGEND Reporter helps managers pinpoint problems with the setup of pools or with users' understanding of which lines they should access for specific purposes.

MERLIN LEGEND Reporter includes the following major features:

- **Call Collection.** MERLIN LEGEND Reporter collects call records from the MERLIN LEGEND Communications System's SMDR (Station Message Detail Recording) feature. It uses one of the three following methods:



NOTE:

For more information about this system feature, see [“Station Message Detail Recording \(SMDR\)” on page 655](#).

- Direct connection to the SMDR jack on the control unit
 - File transfer from another application that collects the call information from the SMDR jack
 - A Pollable Storage Unit (PSU) that connects to the control unit and passes record information to MERLIN LEGEND Reporter through a modem or direct connection
- **Call Processing.** MERLIN LEGEND Reporter processes call record details and stores them in a database. With caller identification services, the application can automatically and immediately print out the incoming telephone numbers of callers who abandoned their calls while waiting for an agent, allowing a rapid return call from the organization. In addition, the application can mask certain outgoing telephone numbers to ensure privacy where needed (for example, on an executive's private line).
 - **Reports.** MERLIN LEGEND Reporter produces an extensive library of reports to help in analyzing facilities and calling groups. You can set up reports to run automatically at preset intervals or on demand. Some reports are tabular only, while others allow the manager to see a chart as well. User-customizable reports are organized into the following categories:

- **Organization.** Detailed call records according to user-specified criteria, summary statistics on specified types of calls, cost center summaries by organization, and summary trends reports are available.
 - **Account Code.** Callers can input codes to identify the subject of a call, the client account number, or other information. Summary and detail call reports are organized by account code.
 - **Selection.** Providing summary and detail information according to very specific criteria, these reports include the duration of calls and how long agents spent actually talking to customers. They allow a manager to pinpoint details or summarize trends, particularly in problem areas.
 - **Traffic.** Primarily covering incoming calls, you can select reports by date, time of day, extension, calling areas where calls originated, and talk and queue (wait) time. Facility reports describe the lines in each facility and report busy-hour incoming and outgoing volume, durations, and performance against user-defined service goals.
- **Archives.** The application maintains data from the previous accounting period. You may move it to a backup storage medium and restore it when you need historic reports.
 - **Remote Access.** Optionally, you can install remote access software and a modem to allow remote assistance from the Lucent Technologies customer helpline.
 - **Multi-Site Network.** MERLIN LEGEND Reporter can work in a network configuration where one central site receives SMDR information from multiple sites and multiple MERLIN LEGEND Communications System control units for central processing and reporting.

Mode Differences

The system must operate in Hybrid/PBX mode. MERLIN LEGEND Reporter does not work with systems in Key or Behind Switch mode.

Considerations and Constraints

MERLIN LEGEND Reporter does not work in a system where another application accesses the SMDR jack on the control unit. Such applications include all configurations of Call Accounting System (CAS) and Call Accounting Terminal (CAT).

MERLIN LEGEND Reporter and Call Accounting System (CAS) should not be active on the system at the same time. Use MERLIN LEGEND Reporter when you primarily need to assess facilities and agent performance. CAS is used for costing purposes.

System reports take precedence over the SMDR information generated for MERLIN LEGEND Reporter. In order to print system reports using the SMDR jack on the control unit, the MERLIN LEGEND Reporter serial connection to the port must be disconnected. MERLIN LEGEND Reporter information is queued while system reports are generated. For smoother operation, use System Programming and Maintenance (SPM) software to print system reports from a printer connected to a PC running SPM. For more information about SPM, see [“System Programming and Maintenance” on page I-29](#).

MERLIN LEGEND Reporter does not report inside calls.

You must program a calling group as Auto Login or Auto Logout in order for its call records and facilities usage to be analyzed using MERLIN LEGEND Reporter. Make sure that the SMDR Talk Time option is enabled.

The application does not report talk times for calls answered by a delay announcement device, calling group overflow receiver, or QCC queue overflow receiver.

Feature Interactions

Account Code Entry	If SMDR is set to record outgoing calls only, account codes cannot be reported on incoming calls. If a remote access barrier code is entered for an incoming call and then an account code is entered, the account code only (not the barrier code ID) is recorded.
Authorization Code	If an account code is not entered, the call record contains the authorization code used to obtain calling privileges. If an account code is entered at any time during a call, the account code is stored in the record.
Auto Dial	All calls made to an outside number using Auto Dial are recorded.
Automatic Route Selection	Outgoing call reports for systems with Automatic Route Selection (ARS) show all the digits dialed by the user, including any digits absorbed by the system and the facility used to make the call. The records do not include the ARS dial-out code or any digits added by ARS.
Callback and Call Waiting	SMDR begins measuring the duration of callback calls when the line/trunk is seized and the system begins dialing the call. Call-waiting calls are measured as soon as the call is answered.
Caller ID	Calling party numbers (if available) for incoming calls (including remote access calls) that are received on a facility with Caller ID are recorded only if the SMDR report is set for ISDN format.
Camp-On	If an incoming call is camped on but is not picked up by the other extension, the extension of the user that activated Camp-On is shown in reports. If an incoming call is camped on and picked up by the destination extension, the destination extension is shown in the report.

Conference	<p>When a conference call includes inside and outside participants, records are generated only for outside participants. When a call is dropped from a conference call, it is considered a completed call.</p>
Coverage	<p>When a calling group is programmed as a Group Coverage receiver, calls are reported following the same rules that apply to other incoming Auto Logout or Auto Logout calling group calls, even if a call is transferred from an operator to a Group Coverage sender before being directed to the calling group.</p>
Forward and Follow Me	<p>When an outside call is forwarded to an outside telephone number, MERLIN LEGEND Reporter captures the incoming call in one record; another record shows the call made to the destination telephone number, with the forwarding telephone as the originator.</p> <p>A user presses # to complete the Remote Call Forwarding number to which incoming calls should be forwarded. The report includes the # with the number for calls forwarded to the number.</p>
Group Calling	<p>In Release 6.1 and earlier systems, calls to calling groups are associated with the first extension to handle the call. If the call is answered by the calling group delay announcement device and the caller hangs up, the extension for the delay announcement device is recorded on the record. Timing for an incoming call to an Auto Login or Auto Logout calling group (assuming that the Talk Time option is enabled) begins when a call arrives at the system. If the caller hangs up while listening to a delay announcement, the call is associated with the extension of the delay announcement device.</p> <p>In Release 7.0 and later systems, when a call is abandoned while in queue at an Auto Login/Logout calling group, the calling group's extension is logged into the SMDR record regardless if it was the first or later extension that handled the call. Similarly, when a call is abandoned while ringing at a calling group member's extension, that extension is logged into the SMDR record regardless if it was the first or later extension that handled the call.</p> <p>Incoming calls that go to an overflow receiver or to an extension not in the calling group are reported as such.</p>
Last Number Dial	<p>All calls made to outside numbers using Last Number Dial are recorded.</p>
Multi-Function Module	<p>A Multi-Function Module (MFM) is treated as an MLX telephone on reports.</p> <p>The system waits until the end of dialing before sending a connect message to the MFM. Any digits dialed after the connect message is received are not recorded.</p>
Paging	<p>Paging calls are not reported.</p>

Park	If an incoming call is parked but is not picked up by the other extension, the extension of the user who activated Park is recorded. If an incoming call is parked and picked up by the destination extension, the destination extension is recorded.
Personal Lines	If a personal line is assigned to an Auto Login or Auto Logout calling group and is shared by extensions that do not belong to that group, the report marks call records answered by a non-group extension.
Pickup	The extension of the person answering the call and using Pickup is shown on the report.
Pools	For outgoing calls made by using a pool, the line/trunk selected by the system is reported.
Power Failure Transfer	During a commercial power failure, all calls are disconnected and no records are generated for calls made using a Power Failure Transfer telephone.
Recall/Timed Flash	If a multiline telephone user presses the Recall button to get a new dial tone, timing is stopped for the previous call and timing begins for a new call.
Remote Access	<p>If a remote access barrier code is entered for an incoming call and then an account code is entered, only the account code (not the barrier code ID) appears on the report.</p> <p>If the caller uses Remote Access to dial out on a line or trunk, the extension information is blank on the first record and a second record is generated for the outgoing call.</p>
Saved Number Dial	All calls made to outside numbers using Saved Number Dial are recorded.
SMDR	<p>MERLIN LEGEND Reporter collects call information from the SMDR output of the system. To print system reports without interrupting the collection of SMDR information, use System Programming and Maintenance (SPM) software to print reports from a PC's printer, not from the SMDR port.</p> <p>For use with MERLIN LEGEND Reporter, the optional SMDR TALK field should be enabled using system programming.</p>
Speed Dial	When Personal Speed Dial or System Speed Dial is used to dial an outgoing call, the actual digits dialed by the system appear on the report. When a marked System Speed Dial number is used, however, the System Speed Dial code prints rather than the digits dialed.
System Access/ Intercom Buttons	When a call is made on a Shared SA button, the SMDR report records the extension number that the call was made from, not the principal extension number.

Transfer The number of the extension that hangs up on an incoming outside call is reported, regardless of how many times the call is transferred. For outgoing outside calls, the number of the extension that dialed the call is shown, even if the call is later transferred to another extension.

Voice Messaging Systems In Release 4.2 and later systems, if an automated attendant or voice response unit transfers an outside call to an Auto Logout or Auto Logout calling group, a call record is created in the same way that it is for other incoming calls to this type of group.

System Programming and Maintenance

IMPORTANT:

This section is intended solely as an overview of the application. For comprehensive information about the use of the application, see the documentation for the product.

System Programming and Maintenance (SPM) software lets you program and maintain the system. It performs the same functions as an MLX-20L telephone set up as a system programming console, providing a display that emulates the console display. SPM also has other features, such as the abilities to back up and restore system programming and to print reports.

Three versions of SPM are available:

- **WinSPM.** For Release 6.0 and later systems, WinSPM provides a graphical user interface (GUI) for those tasks commonly performed by the system manager. Included in WinSPM are pictorial representations of system components (such as modules and their vintages). WinSPM also provides an SPM DOS Emulator mode that allows basic SPM programming of all releases of the MERLIN LEGEND System. Also supported in Release 6.1 and later systems is SPM programming for options not included in the GUI. WinSPM is supported in Windows 95, Windows NT, and Windows 98.
- **SPM.** This stand-alone version runs on a Lucent Technologies-approved DOS PC. Version 4.25, for Release 4.1 and later systems, runs as a DOS application under Windows 95.
- **SPM UNIX.** This version runs under the UNIX system. This version is used for Integrated Solution III existing installations only (IS III is no longer available). UNIX-SPM cannot coexist with Release 5.0 or later Intuity applications.

You can connect a PC with DOS-based SPM directly to the control unit or you can access the system remotely in one of the following ways:

- The system programmer dials the system directly. You can set up a password to prevent unauthorized access.
- The system programmer dials the system operator and asks to be transferred to the system's built-in modem (dial code *10).

You can use SPM UNIX only through a direct local connection.

You can program SPM DOS to operate in English, French, or Spanish. Independently of the overall language setting, you can select one of these languages for the console-simulation window during the current session. WinSPM is available only in English.

See *System Programming* for complete information and requirements for SPM DOS. See the documentation that comes with the product for complete information about WinSPM.

Considerations and Constraints

When you upgrade to a new system release, you must upgrade the system software; typically you must upgrade SPM as well. For more information, see *System Programming*.

Unless the system is being backed up or restored, a remote system programming connection takes priority over a local user. If the local user is programming when a remote user connects to the system, the system sends a warning message to the local user and disconnects that user.

The PC used for system programming connects to the lower RS-232 jack on the processor module in the control unit. This connection runs at 1.2 or 2.4 kbps with autobaud switching.

You can print system programming reports and/or save them on the PC's hard or floppy disk drive. At the same time, the report is displayed on the screen together with prompts for browsing.

You should not print system programming reports when the system is handling more than 100 calls per hour.

You can use a printer connected to the system programming PC to print system reports. Alternatively, you can send reports to a printer connected to the SMDR port on the control unit [for more information about SMDR, see ["Station Message Detail Recording \(SMDR\)" on page 655](#)]. SMDR information may be lost,

however, while system programming reports are being printed through the SMDR port.

Intuity

IMPORTANT:

This section is intended solely as an overview of the applications available for the Intuity platform. For comprehensive information about the use of the applications, see the documentation for the products.

Intuity is Lucent Technologies' messaging solution. It provides a single, integrated interface to any of the following applications (your package may not include all of these):

- **AUDIX Voice Messaging.** Allows the recording and exchanging of voice messages, including stored voice prompts to help users create, store, retrieve, answer, send, or forward voice mail. It also answers calls for people who are busy or unavailable.
- **Fax Messaging.** Allows Intuity AUDIX subscribers to handle faxes using voice mail capabilities. Users can send, receive, annotate, forward, broadcast, and otherwise handle a fax message just as they do a voice message. Voice, fax, and voice/fax messages are received in the same mailbox. Callers and subscribers can access voice and fax capabilities with a single call.
- **Inter Exchange Server.** A network server that acts as a hub. Each site in the network is connected to the Inter Exchange Server, rather than having to be connected to each other. When the Inter Exchange Server is updated, all the systems in the network are automatically updated.
- **Call Accounting System.** Intuity Call Accounting System collects and processes call records from the communications system, generating reports about facilities, extension, and traffic. The system is designed for costing purposes.
- **Message Manager.** Allows Intuity AUDIX subscribers to use their PCs to monitor and control AUDIX messages. In addition, if Intuity Fax Messaging is included in the system, subscribers can display and print faxes received in their mailboxes.

Intuity CONVERSANT

IMPORTANT:

This section is intended solely as an overview of the application. For comprehensive information about the use of the application, see the documentation for the product.

Intuity CONVERSANT is a voice response system that enables a user to run integrated voice response (IVR) applications. Intuity CONVERSANT can automatically answer and route calls and execute telephone transactions. It is particularly useful for order-taking, for example.

You can configure the Intuity CONVERSANT software in one of two ways:

- As an application development environment in which all the tools to create an application are available.
- As a platform to run applications that are already developed.

Intuity CONVERSANT consists of the hardware and software that support transaction processing, data retrieval, and data entry using a touch-tone telephone connected to a public telephone network. When a telephone connection is made to Intuity CONVERSANT, the application running on Intuity CONVERSANT prompts the caller with a synthesized voice in an application-dependent dialogue. The caller enters the appropriate responses by using the touch-tone keys on the telephone. This interaction continues until the caller ends the call.

You can develop applications that allow calls to be transferred to an attendant telephone during some part of the dialogue. Calls also can be transferred automatically to an attendant telephone if the application determines that an attendant is required. Intuity CONVERSANT also supports scripts that allow callers to record and play back information.

Intuity CONVERSANT offers the following capabilities:

- Customized inbound call management or call routing
- Functions that are performed by choosing options in windows displayed on the screen
- Multiple script configuration possibilities that allow for different paths within the same script for handling calls during normal business hours, after hours, and on holidays
- Simple prompt-recording using a telephone
- Optional seasonal greetings to be played during set time intervals

- Interaction of applications with voice mailboxes, with the ability to leave and retrieve messages, execute voice mail scripts, or get subscriber information
- Creation of tables and retrieval and updating of data using database tables
- Logging and displaying error messages
- Management reports and a system monitor for monitoring daily and ongoing system progress

Considerations and Constraints

Intuity CONVERSANT supports a maximum of 24 channels of analog ports, or up to 6 IVP4 boards. In a coresident environment, such as Intuity CONVERSANT and Intuity AUDIX Voice Power, the system supports a maximum of 16 channels. The number of channels assigned to AUDIX Voice Power can *never* exceed 12.

TransTalk 9000 Digital Wireless System

The TransTalk 9000 Digital Wireless System enables you to use a wireless multiline telephone up to 900 feet from a radio module connected to the control unit. The TransTalk system consists of a carrier assembly, radio modules, charging cradles, and multiline pocket telephones. Each pocket telephone requires two radio modules, and each radio module must connect to an extension port on a 412 LS-ID-ETR or 016 ETR module (Release 7.0 and later systems).

The TransTalk system is available in a single-zone and a dual-zone model. The single-zone system provides a range up to 500 feet; the dual-zone system provides a range up to 900 feet.

The pocket telephone contains a 1x16 alphanumeric display, which shows internal calling party information and the external called number. If Caller ID is available, the Caller ID information appears on the pocket telephone's display.

The pocket telephone has up to 10 line buttons and two intercom buttons.

The carrier assembly holds up to six radio modules. Up to three carrier assemblies are supported in Key systems; up to five carrier assemblies are supported in PBX systems. Consequently, up to 18 users can be connected in a single zone in a Key system. Up to 30 users can be connected in a single zone in a PBX system.

Business Cordless 905 Telephone

Like the TransTalk 9000 system, the Business Cordless 905 telephone is a wireless multiline telephone that connects to a radio base connected to an enhanced tip/ring port on a 412 LS-ID-ETR or 016 ETR module (Release 7.0 and later systems). The Business Cordless 905 consists of the following:

- Multibutton handset with display
- Radio base and charging unit
- Power supply for radio base
- Plastic belt clip
- Battery
- 7-foot mounting cord

The Business Cordless 905 telephone can operate up to 125 feet from the radio base and has up to three line buttons and two intercom buttons. In addition, the telephone has a two-line display, which can show Caller ID information when available.

Videoconferencing



NOTE:

Through its support of high-speed digital facilities, the system allows you to use several types of advanced data communications applications, including videoconferencing and rapid data transfer. For more information about digital facilities and adjuncts, see the following topics:

- [“Basic Rate Interface \(BRI\)” on page 99](#)
- [“CTI \(Computer Telephony Integration\) Link” on page 208](#)
- [“Digital Data Calls” on page 223](#)
- [“Primary Rate Interface \(PRI\) and T1” on page 509](#)
- [“ISDN Terminal Adapter” on page I-41](#)

The system supports two types of videoconferencing systems:

- **Desktop Videoconferencing Workstation.** This type of data workstation typically consists of a PC or LAN workstation with one or more videoconferencing circuit boards installed; the video system is equipped with an ISDN-BRI interface. A microphone, software, and a video camera are also included. This type of video workstation does not require separate data communications equipment.

- **Group Videoconferencing Workstations.** Group videoconferencing equipment is usually more expensive than desktop equipment and provides more capabilities. Such stand-alone systems include a built-in monitor and are installed in conference rooms or on roll-about units. There are two types of group videoconferencing workstations:
 - **ISDN Group Videoconferencing Workstations.** ISDN group videoconferencing systems do not require separate data communications equipment and are equipped with an ISDN-BRI interface.
 - **V.35 Group Videoconferencing Workstation.** This type of data workstation usually consists of a roll-about or built-in videoconferencing system as its data terminal equipment. The data communications equipment consists of two ISDN terminal adapters and sometimes two EIA 232/V.35 converters. The converters are not needed when the equipment includes interfaces other than V.35, such as V.24. Sometimes an inverse multiplexor (IMUX) is connected instead of the two terminal adapters.



NOTE:

For complete information about videoconferencing, see the *Data/Video Reference*. In this guide, ["Digital Data Calls" on page 223](#) includes details about how the system functions with 2B data.

Videoconferencing requires PRI, BRI, or T1 Switched 56 digital services for communications at 56 or 64 kbps (kilobits per second) per channel or B-channel. Many videoconferencing systems require two channels, for speeds of 112 or 128 kbps.

Basic video system components include the following:

- Camera
- Microphone
- Video codec circuitry that digitizes and compresses audio and video signals
- Cables
- Software

Additional data communication equipment may be built-in or required as separate components.

Group and desktop videoconferencing systems differ primarily in the capabilities and sophistication of the equipment and software that they include. The type of *interface*, not whether they are designed for groups or individuals, differentiates their use with the communications system.

Making and receiving voice calls are not supported on telephones included with videoconferencing systems.

Group Videoconferencing

Group videoconferencing enables groups of people in different geographical locations to meet face to face. Conferees can exchange information, documents, ideas, and data while employing a variety of visual aids. Visual aids can include interactive writing and drawing, prepared text and graphic materials, and prerecorded audio and video material. Improved technology, superior camera optics, and digital audio signals result in video pictures that are equal to commercial broadcast quality.

Users start videoconferences from an easy-to-use control console and conduct the conference as easily as they operate a telephone. No special technical expertise is required.

Group video systems are often integrated in a mobile roll-about console that can be wheeled easily into a conference room or executive office prior to a scheduled videoconference call. Alternatively, the components can be built into a videoconference room.

Older group videoconferencing systems use V.35 interfaces, requiring two ISDN terminal adapters or an inverse multiplexor (IMUX); these components are sometimes included with the systems. Newer group videoconferencing systems use ISDN/BRI interfaces and include data communications equipment.

Desktop Videoconferencing

Desktop videoconferencing allows video calls, data transfer, and screen-sharing between two PCs equipped with compatible hardware and software. Most systems provide extensive menu- and mouse-driven interfaces with options for call control. Desktop videoconferencing systems use ISDN/BRI interfaces.

With stand-alone configuration, only the desktop video system is attached to the MLX port. The desktop video system always has full access to two B-channels in its connection to the MERLIN LEGEND Communications System. Therefore, it always has the capability to make and receive 2B data video calls.

Mode Differences

Key Mode

In Key mode, a video workstation can be set up for inside video only, outside video only, or both inside and outside video. To place and receive calls in this mode, a video workstation uses personal lines or intercom lines programmed for the MLX adjunct extension.

Hybrid/PBX Mode

As in Key mode, a video workstation in Hybrid/PBX mode can be set up for inside video-only, outside video-only, or both inside and outside video operation.

Considerations and Constraints

Generally, video workstations should have exclusive use of their own lines and dedicated pools (Hybrid/PBX mode only). Because they require two lines for optimal performance, sharing lines is often not practical. Pools should be assigned only lines that provide like services (for video systems, T1 data-only, or PRI and BRI voice and data). ARS should also be programmed so that extensions access pools with the proper grouped facilities (T1 or analog voice only, T1 data only, or PRI/BRI voice and data). ARS default local and toll tables should be programmed to route calls according to their type: voice only, data only, or both voice and data. For more information, see [“Automatic Route Selection” on page 77](#), [“Basic Rate Interface \(BRI\)” on page 99](#), and [“Primary Rate Interface \(PRI\) and T1” on page 509](#).

Feature Interactions

Features that redirect the destination of a call (for example, Coverage features and Forwarding) are not often practical for extensions used by videoconferencing systems. For example, if a video system is a coverage sender, a receiving video system can be assigned only one Cover button for the sender. Therefore, it cannot receive both calls of a 2B video call.

Data hunt groups are not practical where 2B data is required, because two calls must arrive at the destination video system, and data hunt groups distribute the two calls that make up a 2B data call to two different data hunt group members.

The following list details specific feature interactions. For additional information, see the *Data/Video Reference*

Account Code Entry	Account Code Entry can be entered for calls made by video systems that support the use of # for feature codes. The account code must be entered before the telephone number.
Authorization Code	Authorization codes can be used by video systems that support the use of # for feature codes.
Auto Dial	A video system that supports the use of entering # for feature codes can use Auto Dial in the same fashion.
Automatic Route Selection	Video calls can be made using ARS. To make calls using ARS, video systems simply dial the ARS dial-out code (usually 9) followed by the telephone number. The calls <i>must</i> be routed through ARS pools that have only PRI, NI-1 BRI, and/or Switched 56 T1 data lines. To make a 2B data call, the user must access two separate lines.
Barge-In	Video calls cannot be barged into.

Call Waiting	Call waiting does not work with video calls. The call appears to wait but does not return to the extension when it becomes available. This feature should be disabled at video system extensions.
Callback	<p>Video systems can be programmed for Callback. When either a pooled line becomes available or the busy video system is idle, the queued call is made, one B-channel at a time. When the second B-channel becomes available, it is added to the call if the video system supports this capability. Off-hook Callback must be used.</p> <p>Automatic Callback should be disabled for videoconferencing extensions.</p>
Camp-On	Video calls cannot be camped on.
Conference	Conference does not function with video calls.
Coverage	<p>2B data video calls require both B-channels at a video workstation.</p> <p>Individual Coverage is not recommended for 2B data calls. Because a coverage receiver can have only one Cover button for each coverage sender, covered 2B data calls are received only as 1B data calls at the coverage receiver. The second call also continues to ring at the coverage sender.</p> <p>Coverage is not recommended for video extensions.</p>
Directories	Videoconferencing systems cannot make use of Extension, Personal, or System Directories.
Do Not Disturb	Do Not Disturb can be activated by video systems that have the ability to dial strings and feature codes beginning with #.
Forward and Follow Me	<p>Forward can be activated by video systems that have the ability to dial strings and feature codes beginning with #. 2B data calls are forwarded as two 1B data calls.</p> <p>Remote Call Forwarding is not available at video system extensions.</p>
Group Calling	When receiving calls through a calling group or data hunt group, video systems can connect only using 1B data connections and only if the video application supports 1B data. A calling group dispenses only one call to each calling group member.
Hold	<p>Video calls cannot be put on hold.</p> <p>2B data video calls require both B-channels at a video workstation.</p>
Last Number Dial	Last Number Dial can be activated by video systems that can dial strings and feature codes beginning with #.
Messaging	Messaging features are not available for video extensions.
Multi-Function Module	An MFM cannot be used with a digital communications device or videoconferencing system.

Night Service	If a videoconferencing system is a member of the Night Service group, voice calls to Night Service group do not ring at these extensions. Video calls <i>do</i> ring, and 2B data calls can be established. However, if there are two or more 2B data extensions in the system assigned to Night Service groups, 2B data calls can be answered at the wrong extension during Night Service.
Notify	Signaling can be activated by video systems that have the ability to dial strings and feature codes beginning with #.
Paging	Videoconferencing systems can be assigned to a paging group. However, they should not be: they are not alerted if there is a call to a paging group, and they cannot make group pages.
Park	Video calls cannot be parked.
Personal Lines	Personal lines can be assigned to videoconferencing systems. It is best for these extensions to have exclusive use of their own personal lines; if they do not, the system manager should ensure that enough idle lines are available, particularly when a video system is receiving 2B data calls. Otherwise, the video system may receive only 1B data while another extension is using a second personal line.
Pickup	Pickup is not recommended at video system extensions.
Pools	If a videoconferencing system is programmed to have a single Pool button, two calls to that pool result in a 1B data call. However, if two separate pools are assigned to a videoconferencing system extension, then a 2B data call can be established. If a system includes two or more video systems sharing the same pools, incoming 2B data calls can be misrouted.
Privacy	Privacy is activated automatically for video calls.
Reminder Service	Videoconferencing systems cannot receive reminder calls.
Remote Access	Video calls cannot be made into lines programmed for remote access.
Ringng Options	Personalized Ringing and ringing options have no effect on calls to a videoconferencing system.
Speed Dial	Speed Dial codes can be used only on digital video systems that have the ability to dial feature codes or number strings beginning with #.
Tandem Switching	In Release 6.0 and later systems (Hybrid/PBX mode), when tandem PRI trunks connect networked systems, these systems can perform data transfers at speeds up to 128 kbps (2B data). Tandem T1-emulated tie trunks programmed for data can perform data transfers at speeds up to 112 kbps (2B data).
Transfer	2B data video calls require both B-channels at a video workstation.

ISDN Terminal Adapter

IMPORTANT:

This section is intended solely as an overview. For comprehensive information about the use of the terminal adapter, see the documentation for the specific product.



NOTE:

Through its support of high-speed digital facilities, the system allows you to use several types of advanced data communications applications, including Group IV fax, videoconferencing, and rapid data transfer. For more information about digital facilities and adjuncts, see the following topics:

- [“Basic Rate Interface \(BRI\)” on page 99](#)
- [“CTI \(Computer Telephony Integration\) Link” on page 208](#)
- [“Digital Data Calls” on page 223](#)
- [“Primary Rate Interface \(PRI\) and T1” on page 509](#)
- [“Videoconferencing” on page I-34](#)

An ISDN terminal adapter, also referred to as a *digital modem*, allows users to perform high-speed data transfer internally through the MERLIN LEGEND Communications System and over ISDN or T1 Switched 56 lines, at 64 kbps or 56 kbps.



NOTE:

For the most complete information about using terminal adapters with the system, see the *Data/Video Reference*. In this guide, [“Digital Data Calls” on page 223](#) includes details about how the system functions with digital communications devices.

The ISDN terminal adapter can support data calls over Primary Rate Interface B-channels (at 64 kbps), Basic Rate Interface B-channels (at 64 kbps), and T1 Switched 56 lines (at 56 kbps).

Glossary



NOTE:

The use of italics in this glossary denotes a cross-reference to other glossary entries or the expanded name for an acronym.

Numerics

- 2B Data** Digital information carried by two *B-channels* for better performance and quality; the *bit rate* is twice that of one B-channel used alone.
- 7500B Data Module** See [ISDN 7500B Data Module](#).

A

- Account Code** Code used to associate incoming and outgoing calls with corresponding accounts, employees, projects, and clients.
- ACCUNET** AT&T's switched digital service for 56-kbps, 64-kbps restricted, and 64-kbps clear circuit-switched data calls.
- Address** Coded representation of the destination of data or of the data's originating terminal, such as the dialed extension number assigned to the data terminal. Multiple terminals on one communications line each must have a unique address.
- ADDS** *Automated Document Delivery System*. Computer-based application that stores documents in a database and automatically faxes them on request.
- Adjunct** Optional equipment used with the communications system, such as an alerting device or *modem* that connects to a multiline telephone or to an extension jack.
- ALS** *Automatic Line Selection*. Programmed order in which the system makes outside lines available to a user.
- Ambiguous Numbering** Numbering of extension ranges, remote access codes, or other system components that causes conflicts in network operations. These numbers can be unique and still be ambiguous. For example, Extension 441 is different from Extension 4410; for *UDP routing* purposes, however, the two numbers are ambiguous and a call intended for Extension 4410 would be misrouted, on the first three digits sent, to Extension 441. See also [Unambiguous Numbering](#).

AMI	<p><i>Alternate Mark Inversion.</i> Line coding format in which a binary one is represented by a positive or negative pulse, a binary zero is represented by no line signal, and subsequent binary ones must alternate in polarity; otherwise, a <i>bipolar violation</i> occurs. AMI is used in the <i>DS1</i> interface.</p>
Analog Data Station	See Modem Data Station .
Analog Multiline Telephone	Also known as the MERLIN multiline telephone, this telephone transmits and receives analog signals and has a number of line buttons.
Analog Transmission	Mode of transmission in which information is represented in continuously variable physical quantities, such as amplitude, frequency, phase, or resistance. See also Digital Transmission .
ANI	<i>Automatic Number Identification.</i> Process of automatically identifying a caller's billing number and transmitting that number from the caller's local central office to another point on or off the public network.
Application	Software and/or hardware that adds functional capabilities to the system. For example, MERLIN Identifier is an application that provides caller identification information (if available in the local area or jurisdiction).
ARS	<i>Automatic Route Selection.</i> System feature that routes calls on outside facilities according to the number dialed and line/trunk availability. To initiate ARS, the user dials a <i>dial-out code</i> , also called an "ARS access code."
ASCAP	<i>American Society of Composers, Artists, and Producers.</i>
Ascend Pipeline 25PX/75PX	ISDN-BRI bridge/router that enables high-speed Internet access over a digital facility. It makes outgoing calls only.
ASN	<i>AT&T Switched Network.</i> AT&T telecommunications services provided through an Integrated Digital Services Network Primary Rate Interface (ISDN-PRI) trunk, <i>ACCUNET</i> switched digital service, <i>MEGACOM</i> , <i>MEGACOM 800</i> , Software Defined Network (<i>SDN</i>), <i>Multiquest</i> , and Shared Access for Switch Services (<i>SASS</i>).
Asynchronous Data Transmission	Method of transmitting a short bitstream of digital data, such as printable characters represented by a 7- or 8-bit ASCII code. Each string of data bits is preceded by a start bit and followed by a stop bit, thus permitting data to be transmitted at irregular intervals. See also Synchronous Data Transmission .
AT&T Attendant	Application with equipment that connects to one or more <i>tip/ring</i> extension jacks and automatically answers incoming calls with a recorded announcement; directs calls in response to touch tones.

AT&T Switched Network	See ASN .
AUDIX Voice Power	Voice-processing application, part of <i>IS II/III</i> , that provides Automated Attendant, Call Answer, Information Service, Message Drop, Voice Mail, and, optionally, <i>Fax Attendant System</i> for use with the system.
Automated Attendant	<i>IS II/III</i> , <i>MERLIN LEGEND Mail</i> , and <i>Lucent Technologies Attendant</i> application that automatically answers incoming calls with a recorded announcement and directs callers to a department, an extension, or the system operator.
Automated Document Delivery System	See ADDS .
Automatic Immediate Cycling	Process that occurs in a <i>private network</i> when all available routes for a call specify systems with matching <i>switch identifiers</i> . The call is routed from the originating system to the destination system and back to the originating system in a continuous loop. <i>Switch identifier</i> labeling systems must be unique across a network.
Automatic Line Selection	See ALS .
Automatic Number Identification	See ANI .
Automatic Ringdown Tie-Trunk	See Automatic-Start Tie Trunk .
Automatic Route Selection	See ARS .
Automatic-Start Tie Trunk	<i>Tie trunk</i> on which incoming calls are routed to an operator or other designated destination without a start signal, as soon as the trunk is seized; the destination is specified during programming. Also called "Automatic Ringdown" or "Auto-In" Tie Trunk.
Auxiliary Power Unit	Device that provides additional power to the system.

B

B8ZS	<i>Bipolar 8 Zero Substitution</i> . Line-coding format that encodes a string of eight zeros in a unique binary sequence to detect bipolar violations.
Backup	Procedure for saving a copy of system programming onto a floppy disk or <i>memory card</i> . See also Restore .

Bandwidth	Difference, expressed in hertz, between the highest and lowest frequencies in a range that determines channel capacity.
Barrier Code	Password used to limit access to the <i>Remote Access</i> feature of the system. In a <i>private network</i> , it is especially important that barrier codes be required for all types of remote access.
Basic Carrier	Hardware that holds and connects the <i>processor module</i> , <i>power supply module</i> , and up to five other modules in the system. See also Expansion Carrier .
Baud Rate	Strictly speaking, a measurement of transmission speed equal to the number of signal level changes per second. In practice, often used synonymously with <i>bit rate</i> and <i>bps</i> .
B-Channel	<i>Bearer-Channel</i> . 64- or 56-kbps channel that carries a variety of digital information streams, such as voice at 64 kbps, data at up to 64 kbps, wideband voice encoded at 64 kbps, and voice at less than 64 kbps, alone or combined.
Basic Rate Interface	See BRI .
Bearer-Channel	See B-Channel .
Behind Switch Mode	One of three modes of system operation in which the control unit is connected to (behind) another telephone switching system, such as <i>Centrex</i> or <i>DEFINITY</i> , which provides features and services to telephone users. See also Hybrid/PBX Mode and Key Mode .
Binary Code	Electrical representation of quantities or symbols expressed in the base-2 number system, which includes zeros and ones.
Bipolar 8 Zero Substitution	See B8ZS .
Bipolar Signal	Digital signal in which pulses (ones) alternate between positive and negative. See also AMI , B8ZS , and Bipolar Violation .
Bipolar Violation	Condition occurring when two positive or two negative pulses are received in succession. See also AMI and B8ZS .
BIS	<i>Built-In Speakerphone</i> . Part of the model name of some analog multiline telephones.
Bit	<i>Binary Digit</i> . One unit of information in binary notation; it can have one of two values—zero or one.
Bit Rate	Speed at which bits are transmitted, usually expressed in <i>bps</i> . Also called “data rate.”

Blocking	Condition in which end-to-end connections cannot be made on calls because of a full load on all possible services and facilities. See also Glare .
BMI	<i>Broadcast Music Incorporated.</i>
Board	Module—for example, 100D or 408 MLX GS/LS—that allows you to connect lines/trunks and extensions to the communications system.
Board Assignment	System Programming and Maintenance (SPM) procedure for assigning line/trunk and extension modules to slots on the control unit.
Board Renumbering	System programming procedure for renumbering boards that have already been assigned to specific slots on the control unit.
bps	<i>Bits per second.</i>
BRI	<i>Basic Rate Interface.</i> Standard protocol for accessing Integrated Service Digital Network (ISDN) services.
Broadband	Transmission path having a bandwidth greater than a voice-grade channel.
BTMI	<i>Basic Telephone Modem Interface.</i>
Bus	Multiconductor electrical path used to transfer information over a common connection from any of several sources to any of several destinations.
Button	Key on the face of a telephone that is used to access a line, activate a feature, or enter a code on a communications system.
Byte	Sequence of <i>bits</i> (usually eight) processed together. Also called "octet."

C

Call Accounting System	See CAS .
Call Accounting Terminal	See CAT .
Caller ID	Service provided by some local telephone companies (if local regulations allow) that supplies the calling party telephone number. In Release 3.0 and later, an 800 GS/LS-ID module on the system can capture this information and display it on the screens of MLX telephones. In Release 7.0 and later, an 800 GS/LS-ID, 408 GS/LS-ID-MLX, or 412 LS-ID-ETR module can capture both the number and name of the calling party and display them on the screens of MLX, ETR, and MLS telephones. See also ANI .

Calling Group	Team of individuals who answer the same types of calls.
Call Management System	See CMS .
Calling Party Name on Caller ID	This central office service allows a subscriber to view the name of the calling party on an MLX, ETR, or MLS display telephone.
Calling Party Number on Caller ID	This central office service allows a subscriber to view the number of the calling party on an MLX, ETR, or MLS display telephone.
CAS	<i>Call Accounting System</i> . DOS- or UNIX System-based application that monitors and manages telecommunications costs.
CAT	<i>Call Accounting Terminal</i> . Stand-alone unit with a built-in microprocessor and data buffer that provides simple call accounting at a low cost.
CCITT	<i>International Telegraph and Telephone Consultative Committee</i> .
CCS	<i>Common-Channel Signaling</i> . Signaling in which one channel of a group of channels carries signaling information for each of the remaining channels, permitting each of the remaining channels to be used to nearly full capacity. In the system's 100D module, channel 24 can be designated as the signaling channel for channels 1–23.
Centralized Telephone Programming	Programming of features on individual telephones; performed at a central location by the system manager. See also System Programming and Extension Programming .
Centralized Voice Messaging	Sharing of a voice messaging system by two or more directly connected MERLIN LEGEND Systems in a <i>private network</i> . Available beginning in Release 6.1.
Central Office	See CO .
Centrex	Set of system features to which a user can subscribe on telephone trunks from the local telephone company.
Channel	Telecommunications transmission path for voice and/or data.
Channel Service Unit	See CSU .
Checksum	Sum of ones in a sequence of ones and zeros, used to detect or correct errors in data transmission.
Circuit-Switched Data Call	Data call made through an exclusively established and maintained connection between <i>data stations</i> .
Class of Restriction	See COR .

Clear Data Channel	Clear data channels (also called unrestricted data channels) allow the transmission of occurrences of more than seven contiguous zero bits. If a clear data channel is requested and only restricted channels are available, the call will be rejected. See also Restricted Data Channel .
Clock Synchronization	When digital signals are transmitted over a communications link, the receiving end must be synchronized with the transmitting end to receive the digital signals without errors using clock synchronization. A system synchronizes itself by extracting a timing signal from an incoming digital stream. All the digital facilities in a network operate from a single common clock—preferably a port connected to a digital <i>PSTN</i> facility on a <i>hub system</i> or a system that connects two network systems. In this case, all digital facilities specify a loop clock source. One system in a network may be specified as a local clock source when no functioning digital facility in the network is connected to the <i>PSTN</i> . All other digital facilities then use this clock and specify their clock sources as loop. Primary, secondary, and tertiary clock sources are specified to allow backup synchronization in the event that the primary source is out of service.
CMS	<i>Call Management System</i> . DOS-based application that simulates the actions of a system operator by answering and distributing calls. Also produces reports for call analysis.
CO	<i>Central Office</i> . Location of telephone switching equipment that provides local telephone service and access to toll facilities for long-distance calling.
Coaxial Cable	Cable consisting of one conductor, usually a small copper tube or wire within, and insulated from, another conductor of larger diameter—usually copper tubing or copper braid.
Codec	<i>Coder-Decoder</i> . Device used to convert analog signals—such as speech, music, or television—to digital form for transmission over a digital medium and back to the original analog form.
Collected Digits	Digits that a caller dials in response to an integrated voice response application's menus (also called <i>prompted digits</i>); collected digits may be used to initiate a <i>screen pop</i> at a system extension. See also CTI Link .
Combination Configuration	<i>Private network</i> arrangement that combines characteristics of <i>Virtual Private Network (VPN)</i> , a <i>series configuration</i> , and a <i>star configuration</i> .
Common Channel Signaling	See CCS .

Communications System	Software-controlled processor complex that interprets dialing pulses, tones, and/or keyboard characters and makes the proper interconnections—both inside and outside. Consists of a computer, software, a storage device, and carriers with special hardware to perform the actual connections. Provides voice and/or data communications services, including access to public and private networks, for telephones and other equipment. Also referred to in this guide as “system,” short for MERLIN LEGEND Communications System.
Control Unit	<i>Processor module, power supply module, other modules, carriers, and housing of the system.</i>
Console	Telephone and <i>adjuncts</i> (if any) at an operator or system programmer extension.
CONVERSANT	Entry-level voice response application that automatically answers and routes calls and executes telephone transactions.
Conversion Resource	See Modem Pool .
Coordinating System Manager	In a <i>private network</i> that includes more than two systems, the system manager who acts as a clearinghouse for any changes made on local systems that affect the network, assuring that all system managers work together and that local system changes do not have undesirable effects on the network as a whole.
COR	<i>Class of Restriction.</i> Various types of restrictions that can be assigned to <i>remote access</i> trunks or barrier codes. These restrictions consist of calling restrictions, <i>ARS Facility Restriction Levels (FRLs)</i> , Allowed Lists, Disallowed Lists, and Automatic Callback queuing.
Coverage	Set of system features that can determine how an extension’s calls are covered when the person at the extension is busy or not available.
CRC	<i>Cyclic Redundancy Check.</i> Error-detection code used on <i>DS1</i> facilities with the extended superframe format (<i>ESF</i>).
CSU	<i>Channel Service Unit.</i> Equipment used on customer premises to provide <i>DS1</i> facility terminations and signaling compatibility.
CTI Link	<i>Computer Telephony Integration.</i> Hardware/software feature that is part of the PassageWay Telephony Services application. It allows the use of Lucent Technologies-certified software applications on a <i>LAN</i> running Novell NetWare software in a <i>Hybrid/PBX mode</i> system. These applications may provide special features for client control of such calling activities as power dialing. See also Screen Pop .

Cyclic Redundancy Check See [CRC](#).

D

D4 Framing Format *Framing format* consisting of a sequence of individual frames of 24 eight-bit slots and one signal bit (193 bits) in a 12-frame superframe. See also [ESF](#).

Data-Channel See [D-Channel](#).

Data Communications Equipment See [DCE](#).

Data Module Type of *ISDN terminal adapter* that acts as the *DCE* at a *data workstation* that communicates over high-speed *digital* facilities.

Data Rate See [bps](#).

Data Station Special type of extension where data communications take place; includes *DTE* and *DCE*; sometimes a telephone is also part of a data station.

Data Terminal Input/output device (often a personal computer) that can be connected to the control unit via an interface.

Data Terminal Equipment See [DTE](#) and [Data Terminal](#).

Data Workstation Special type of extension where data communications take place; includes *DTE* and *DCE*; sometimes a telephone is also part of a data workstation.

DCE *Data Communications Equipment*. Equipment, such as *modems* or *ISDN terminal adapters*, used to establish, maintain, and terminate a connection between the system and data terminal equipment (*DTE*)—such as printers, personal computers, host computers, or network workstations.

DCP *Digital Communications Protocol*. AT&T proprietary protocol to transmit digitized voice and data over the same communications link.

D-Channel *Data-Channel*. 16- or 64-kbps channel that carries signaling information or data on a *PRI* or *BRI*.

Dedicated Feature Buttons The imprinted feature buttons on a telephone: Conf or Conference, Drop, Feature, HFAI (Hands-Free Answer on Intercom), Hold, Message, Mute or Microphone, Recall, Speakerphone or Spkrphone, and Transfer.

Delay-Start Tie Trunk	<i>Tie trunk or tandem tie trunk</i> on which the originating end of the tie trunk transmits an off-hook signal to the receiving end and waits for the receiving end to send an off-hook signal followed by an on-hook signal. Also called “dial-repeating tie trunk.”
Desktop Videoconferencing System	System application that allows face-to-face, simultaneous video and voice communications between individuals and requires high-speed data transmission facilities. See also Group Videoconferencing System .
DFT	<i>Direct Facility Termination</i> . See Personal Line .
DHG	<i>Data Hunt Group</i> . Group of analog or digital <i>data stations</i> that share a common access code. Calls are connected in a round-robin fashion to the first available data station in the group.
Dial Access	See Feature Code .
Dialed Number Identification Service	See DNIS .
Dial-Out Code	Digit (usually a 9) or digits dialed by telephone users to get an outside line.
Dial Plan	Numbering scheme for system extensions, lines, and trunks.
Dial-Repeating Tie Trunk	<i>Tie trunk</i> on which the originating end of the tie trunk transmits an off-hook signal to the receiving end and waits for the receiving end to send an off-hook signal followed by an on-hook signal. Also called “dial-repeating tie trunk.”
DID	<i>Direct Inward Dial</i> . Service that transmits from the telephone company central office and routes incoming calls directly to the called extension, <i>calling group</i> , or outgoing line/trunk <i>pool</i> , bypassing the system operator.
DID Trunk	Incoming trunk that receives dialed digits from the local exchange, allowing the system to connect directly to an extension without assistance from the system operator.
Digital	Representation of information in discrete elements—such as off and on or zero and one. See also Analog Transmission .
Digital Communications Protocol	See DCP .
Digital Data Station	See ISDN Terminal Adapter Data Station .
Digital Signal 0	See DS0 .
Digital Signal 1	See DS1 .

Digital Subscriber Line	See DSL .
Digital Transmission	Mode of transmission in which the information to be transmitted is first converted to digital form and then transmitted as a serial stream of pulses. See also Analog Transmission .
DIP Switch	<i>Dual In-line Package</i> . Switch on a 400EM module used to select the signaling format for tie-line transmission. Also used on other equipment for setting hardware options.
Direct Facility Termination	<i>DFT</i> . See Personal Line .
Direct Inward Dial	See DID .
Direct-Line Console	See DLC .
Direct Station Selector	See DSS .
Display Buttons	Buttons on an MLX display telephone used to access the telephone's display.
DLC	<i>Direct-Line Console</i> . Telephone used by a system operator to answer outside calls (not directed to an individual or a group) and inside calls, to transfer calls, to make outside calls for users with outward calling restrictions, to set up conference calls, and to monitor system operation.
DNIS	<i>Dialed Number Identification Service</i> . Service provided by AT&T and MCI to route incoming 800 or 900 calls according to customer-selected parameters, such as area code, state, or time of call.
Door Answering Unit	Device connected to a <i>tip/ring</i> jack and used at an unattended extension or front desk.
DOS	<i>Disk Operating System</i> .
Drop-and-Insert Equipment	Device that can be installed between systems connected by <i>tandem PRI trunks</i> or T1-Emulated <i>tandem tie trunks</i> to allow fractional use of the facility—that is, use of fewer than 23 of the PRI <i>B-channels</i> or fewer than 24 of the T1 <i>channels</i> . In a PRI facility, the equipment must never drop Channel 24, the <i>D-channel</i> . All channels must still be programmed and all count towards the system maximum of 80 lines.
DS0	<i>Digital Signal 0</i> . Single 64-kbps voice or data channel.
DS1	<i>Digital Signal 1</i> . Bit-oriented signaling interface that multiplexes twenty-four 64-kbps channels into a single 1.544-mbps stream.

DSL	<i>Digital Subscriber Line.</i> Digital Subscriber Line provides full-duplex service on a single twisted metallic pair (2-wire) at a rate sufficient to support ISDN Basic Rate Access.
DSS	<i>Direct Station Selector.</i> 60-button <i>adjunct</i> that enhances the call-handling capabilities of an MLX-20L or MLX-28D telephone used as an operator console.
DTE	<i>Data Terminal Equipment.</i> Equipment that makes the endpoints in a connection over a data connection—for example, a data terminal, personal computer, host computer, or printer.
DTMF signaling	<i>Dual-Tone Multifrequency Signaling.</i> Touch-tone signaling from telephones using the voice transmission path. DTMF signaling provides 12 distinct signals, each representing a dialed digit or character, and each composed of two voiceband frequencies.

E

E&M Signaling	Trunk supervisory signaling, used between two communications systems, in which signaling information is transferred through two-state voltage conditions (on the Ear and Mouth leads) for analog applications and through two <i>bits</i> for digital applications. See also Tie Trunk .
EIA	<i>Electronic Industries Association.</i>
EIA-232-D	Physical interface, specified by the <i>EIA</i> , that transmits and receives asynchronous data at speeds of up to 19.2-kbps over cable distances of 50 feet (15 meters).
Electronic Switching System	See ESS .
Endpoint	Final destination in the path of an electrical or telecommunications signal.
Enhanced Service Center	Application that sends calls to available agents in a calling group. The Enhanced Service Center places calls in queue, plays announcements, tracks agent activity and availability, and provides real-time reports.
ESF	<i>Extended Superframe Format.</i> <i>PRI</i> framing format consisting of individual frames of 24 eight-bit slots and one signal bit (193 bits) in a 24-frame extended superframe.
ESS	<i>Electronic Switching System.</i> Class of central office (<i>CO</i>) switching systems developed by Lucent Technologies in which the control functions are performed principally by electronic data processors operating under the direction of a stored program.
ETR Telephone	Enhanced tip/ring telephones (Series 4) supported in MERLIN LEGEND Release 7.0 and later.

Expansion Carrier	Carrier added to the control unit when the basic carrier cannot house all of the required modules. Houses a power supply module and up to six additional modules.
ExpressRoute 1000	Data communications device that allows connection between an RS-232 <i>DTE</i> device and the control unit, using MLX extension jacks on an MLX module.
Extended Superframe Format	See ESF .
Extension	<i>Endpoint</i> on the internal side of the communications system. An extension can be a telephone with or without an adjunct. Also called "station." See also Data Workstation .
Extension Jack	An analog, digital, or <i>tip/ring</i> physical interface on a module in the control unit for connecting a telephone or other device to the system. Also called "station jack."
Extension Programming	Programming performed at an extension to customize telephones for personal needs; users can program features on buttons, set the telephone ringing pattern, and so on. See also Centralized Telephone Programming and System Programming .

F

Facility	Equipment (often a <i>line/trunk</i>) constituting a telecommunications path between the system and the telephone company central office (CO).
Facility Restriction Level	See FRL .
Factory Setting	Default state of a device or feature when an optional setting is not programmed by the user or system manager.
Fax	<i>Facsimile</i> . Scanning and transmission of a graphic image over a telecommunications facility, or the resulting reproduced image, or the machine that does the scanning and transmitting.
Fax Attendant System	Fax-handling and processing application available with <i>AUDIX Voice Power</i> .
FCC	<i>Federal Communications Commission</i> .
Feature	Function or service provided by the system.
Feature Code	Code entered on a dialpad to activate a feature.
Feature Module	Prior to Release 3.0, circuit pack inserted into the <i>processor module</i> , used to provide system features and replaced when the system is upgraded.

Feature Screen	Display screen on MLX display telephones; provides quick access to commonly used features.
Ferrite Core	Attachment to the AC power cord and ground wire of the carrier power supply for compliance with FCC, part 15 requirements.
Flash ROM	Beginning with Release 3.0, type of read-only memory provided on the <i>processor module</i> , used to supply system features.
Foil Shield	Copper foil sheet (for power units), used to prevent excessive noise on the module.
Forced Idle	Condition of the system during certain programming or maintenance procedures; system prevents initiation of new calls.
Foreign Exchange	See FX .
Fractional-T1	A digital transmission facility consisting of at least one, and fewer than 24, <i>DS0</i> channels using robbed-bit signaling, and connecting a <i>PBX</i> and a <i>central office</i> or toll office.
Frame	One of several segments of an analog or digital signal that has a repetitive characteristic. For example, a <i>DS1</i> frame consists of a framing <i>bit</i> and 24 bytes, which equals 193 bits.
Framing Format	Pattern of <i>frames</i> used in transmissions.
Frequency Generator	See Ring Generator .
FRL	<i>Facility Restriction Level</i> . Calling restriction type that restricts calls to certain specified <i>ARS</i> and <i>UDP</i> routes.
FX	<i>Foreign Exchange</i> . <i>Central office</i> other than the one that is providing local access to the public telephone network.

G

General Purpose Adapter	See GPA .
Glare	Condition that occurs when a user tries to call out on a <i>loop-start line</i> at the same time that another call arrives on the same line.
GPA	<i>General Purpose Adapter</i> . Device that connects an analog multiline telephone to optional equipment, such as an answering machine or a fax machine.
Ground-Start Trunk	Trunk on which the communications system, after verifying that the trunk is idle (no ground on tip lead), transmits a request for service (puts ground on ring lead) to the telephone company <i>central office</i> .

Group IV (G4) Fax Machine	Fax unit, offering 400 by 100 dots per inch (DPI) in fine mode, that can operate at any speed for communication with a Group III (G3) fax machine or another Group IV (G4) fax machine.
Group Videoconferencing System	System application that allows face-to-face, simultaneous video and voice communications between groups and requires high-speed data transmission facilities. See also Desktop Videoconferencing System .

H

Hands-Free Answer on Intercom	See HFAI .
Hands-Free Unit	See HFU .
Headset	Lightweight earpiece and microphone used for hands-free telephone operation.
HFAI	<i>Hands-Free Answer on Intercom</i> . Feature that allows a user to answer a voice-announced call.
HFU	<i>Hands-Free Unit</i> . Unit for analog multiline telephones that allows users to make and receive calls on the speakerphone without using the handset.
Home Screen	Display normally shown on an MLX display telephone; shows time, date, and call information, as well as when some features are in use.
Host	Telephone company or other switch providing features and services to the system users, usually when the system is operating in <i>Behind Switch mode</i> .
Hub System	In a <i>private network</i> that is arranged in a <i>star configuration</i> , the communications system through which all calls across the network pass.
Hybrid/PBX Mode	One of three modes of system operation in which the system uses line/trunk <i>pools</i> and <i>ARS</i> in addition to <i>personal lines</i> . Provides a single interface (SA buttons) to users for both internal and external calling. See also Behind Switch Mode and Key Mode .

I

ICLID	<i>Incoming Call Line Identification</i> . See Caller ID .
ICOM Buttons	<i>Intercom Buttons</i> . Telephone buttons that provide access to inside system lines for calling other extensions or receiving calls from them.

Immediate-Start Tie Trunk	<i>Tie trunk</i> on which no start signal is necessary; dialing can begin immediately after the trunk is seized.
In-Band Signaling	See Robbed-Bit Signaling .
Inside Dial Tone	Tone users hear when they are off-hook on an SA or ICOM button.
Inspect Screen	Display screen on an MLX display telephone that allows the user to preview incoming calls and view a list of the features programmed on line buttons.
Integrated Administration	Capability of <i>IS III</i> that simplifies the programming of common information for the system, <i>AUDIX Voice Power</i> , and, if it is also installed, <i>Fax Attendant System</i> .
Integrated Services Digital Network	See ISDN .
Integrated Solution II/III	See IS II/III .
Integrated Voice Power Automated Attendant	<i>IS II</i> application that automatically answers incoming calls with a recorded announcement and directs callers to a department, an extension, or the system operator.
Intercom Buttons	See ICOM Buttons .
Interface	Hardware and/or software that links systems, programs, or devices.
Intersystem Calls	In a <i>private network</i> , calls between a local extension and a <i>local</i> or <i>non-local dial plan</i> extension.
Intuity	Set of integrated applications that provides voice mail, fax messaging, Automated Attendant, call accounting, and system programming.
Intuity CONVERSANT	Voice response application that automatically answers and routes calls and executes telephone transactions.
I/O Device	<i>Input/Output Device</i> . Equipment that can be attached to a computer internally or externally for managing a computer system's input and output of information.
IROB Protector	<i>In-Range Out-of-Building protector</i> . Surge-protection device for off-premises telephones at a location within 1000 feet (305 meters) of cable distance from the control unit.
IS II/III	<i>Integrated Solution II or Integrated Solution III</i> . Set of UNIX System-based applications that augments and provides additional services using the system. IS II and III are no longer available.

ISDN	<i>Integrated Services Digital Network.</i> Public or private network that provides end-to-end digital connectivity for all services to which users have access by a limited set of standard multipurpose user and <i>network interfaces</i> ; provides digital circuit-switched or packet-switched connections within the network and to other networks for national and international digital connectivity.
ISDN 7500B Data Module	Data communications device that allows connection between an RS-232 <i>DTE</i> device and the control unit by MLX extension jacks on an MLX module.
ISDN Terminal Adapter	<i>Integrated Services Digital Network Terminal Adapter.</i> A device that connects the communications system with <i>data terminal equipment (DTE)</i> .
ISDN Terminal Adapter Data Station	Type of data station that includes an ISDN terminal adapter as its DCE. It may also include an MLX telephone for simultaneous voice and data (ISDN terminal adapter data-only station). These data stations connect to MLX extension jack modules for digital transmission of data over a DS1 facility.

J

Jack	Physical connection point to the system for a telephone, line/trunk, or other device. Also called "port."
-------------	---

K

kbps	<i>kilobits per second.</i>
Key Mode	One of three modes of system operation, in which the system uses personal lines on line buttons for outside calls, with a separate interface (<i>ICOM buttons</i>) for inside calling. See also Behind Switch Mode and Hybrid/PBX Mode .

L

LAN	<i>Local Area Network.</i> Arrangement of interconnected personal computers or terminals, which sometimes access a host computer, and sometimes sharing resources such as files and printers.
LDN	<i>Listed Directory Number.</i>
LED	<i>Light-Emitting Diode.</i> Semiconductor device that produces light when voltage is applied; light on a telephone.
Line	Connection between extensions within the communications system; often, however, used synonymously with <i>trunk</i> .

Line and Trunk Assignment	Assignment of lines and trunks connected to the system control unit to specific buttons on each telephone.
Line Coding	Pattern that data assumes as it is transmitted over a communications channel.
Line Compensation	Adjustment for the amount of cable loss in decibels (dB), based on the length of cable between a 100D module and a channel service unit (CSU) or other far-end connection point.
Line/Trunk	Refers to inside system lines and outside lines/trunks in general terms. See also Line and Trunk .
Line/Trunk Jack	Physical interface on a module in the control unit for connecting an outside line/trunk to the communications system. Also called "trunk jack."
Line/Trunk and Extension Module	Module on which the jacks for connecting central office lines/trunks and/or the jacks for connecting the extensions are located.
Local Dial Plan	In a system that is part of a <i>private network</i> , list of extension ranges that the local system refers to in order to route local <i>intersystem calls via UDP</i> .
Local Extension	In a system that is part of a <i>private network</i> , extension that is listed in the system's <i>local dial plan</i> .
Local Host Computer Access	Method for connecting an extension jack to an on-site computer for data-only calls through a <i>modem</i> or <i>ISDN terminal adapter</i> .
Local Loop	The two-way connection between a customer's premises and the <i>central office</i> .
Local User	In a <i>private network</i> , person whose extension is connected to the local control unit.
Logical ID	Unique numeric identifier for each <i>extension</i> and <i>line/trunk jack</i> in the system control unit.
Loop-Start Line	Line on which a closure between the tip and ring leads is used to originate or answer a call. High-voltage 20-Hz AC ringing current from the <i>central office</i> signals an incoming call.
Lucent Technologies Attendant	Application with equipment that connects to one or more <i>tip/ring</i> (T/R) extension jacks and automatically answers incoming calls with a recorded announcement; directs calls in response to touch tones. This application is no longer available.

M

Magic On Hold	Lucent Technologies Music-On-Hold enhancement that promotes a company's products or services.
----------------------	---

mbps	<i>megabits per second.</i>
Megacom	AT&T tariffed digital <i>WATS</i> offering for outward calling.
Megacom 800	AT&T tariffed digital 800 offering for inward calling.
Memory Card	Storage medium, similar in function to a floppy disk, that allows information to be added to, or obtained from, the communications system through the PCMCIA interface slot on the processor module.
MERLIN Identifier	<i>Adjunct</i> that allows users to receive, store, and use information provided by Caller ID.
MERLIN LEGEND Mail	Voice-messaging system that provides Automated Attendant, call answering, and voice-mail services. It is housed in its own module.
MERLIN Mail	Voice-messaging system that provides Automated Attendant, call answering, and voice-mail services. No longer available.
Messaging 2000	Voice-messaging system housed in a PC that connects to <i>tip/ring</i> ports on the system's modules. Messaging 2000 provides voice mail, Automated Attendant, call answering, and fax messaging services.
MFM	<i>Multi-Function Module.</i> Adapter that has a <i>tip/ring</i> mode for answering machines, modems, fax machines, and <i>tip/ring</i> alerts, and an <i>SAA</i> mode for -48 VDC alerts. It is installed inside an MLX telephone and is used to connect optional equipment to the telephone. The optional equipment and the telephone operate simultaneously and independently.
MLS Telephone	An enhanced <i>tip/ring</i> (Series 3) telephone supported in MERLIN LEGEND Release 7.0 and later. No longer available.
MLX Telephone	Multiline button telephone that transmits and receives digital signals.
Mode Codes	Streams of touch-tone codes used by voice messaging applications to communicate with the system's control unit.
Modem	Device that converts digital data signals to analog signals for transmission over a telephone line, and analog signals received on a telephone line to digital signals.
Modem Data Station	Type of data station that includes a modem as its DCE. It may also include an MLX telephone for simultaneous voice and data (MLX voice and modem data station), an analog multiline telephone (analog voice and modem data station), or a single-line telephone for dialing only (modem data-only station). These data stations connect respectively to MLX, analog, or <i>tip/ring</i> extension jack modules. They provide analog transmission of data.

Modem Pool	Pair, or group of pairs, of <i>modems</i> and data modules with interconnected RS-232 interfaces that converts digital signals to analog, or analog signals to digital, thereby allowing users with <i>ISDN terminal adapter data stations</i> to communicate with users who have analog <i>modem data stations</i> .
Module	Circuit pack in the control unit that provides the physical jacks for connecting telephones and/or outside lines/trunks to the communications system. In the name of a module, the first digit indicates the number of <i>line/trunk jacks</i> it contains; the last digit indicates the number of <i>extension jacks</i> it contains. If no letters appear after the number, a line/trunk module provides <i>loop-start lines</i> or an extension jack module provides analog or <i>tip/ring jacks</i> . For example, a 408 GS/LS-MLX module contains four line/trunk jacks and eight digital (MLX) extension jacks, and provides either <i>loop-start (LS)</i> or <i>ground-start (GS) trunks</i> .
Monitored Extension	Extension for which one or more CTI applications is receiving call information. The CTI application does not have to be directly attached to the equipment at the extension in order to monitor calls. The call information may appear on the PC screen of another extension that has been programmed to receive it. See also CTI Link and Unmonitored Extension .
Multi-Function Module	See MFM .
Multiline Telephone	Analog or digital (MLX) telephone that provides multiple line buttons for making or receiving calls or programming features.
Multiplexing	Division of a transmission channel into two or more independent channels—either by splitting the frequency band into a number of narrower bands or by dividing the channel into successive time slots.
Music-On-Hold	Customer-provided music source or Magic On Hold connected to the system through a <i>loop-start jack</i> .

N

Network	Configuration of communications devices and software connected for information interchange.
Network Interface	Hardware, software, or both that links two systems in an interconnected group of systems—for example, between the local telephone company and a PBX.

NI-1 BRI	<i>National Integrated Services Digital Network 1 Basic Rate Interface.</i> Type of digital facility that carries the equivalent of three lines. Two are called <i>B-channels</i> and provide voice and data communications services. A third <i>D-channel</i> controls signaling and maintains operations on the B-channels.
Non-Local Dial Plan	In a system that is part of a <i>private network</i> , list of extension ranges that the local system references in order to route non-local <i>intersystem calls via UDP</i> .
Non-Local Extension	In a system that is part of a <i>private network</i> , extension that is in the <i>non-local dial plan</i> .
Non-Local User	In a <i>private network</i> , user who is connected to another system in the network and not to the local system.
Non-Satellite System	In a <i>private network, communications system</i> that is directly connected to and located more than 200 miles from the local system.

O

Off-Hook	Telephone is said to be off-hook when the user has lifted the handset, pressed the Speakerphone button to turn on the speakerphone, or used a headset to connect to the communications system or the telephone network.
Off-Premises Telephone	See OPT .
Ones Density	Requirement for channelized <i>DS1</i> service to the public network that prohibits eight consecutive zeros in a digital data stream.
On-Hook	Telephone is said to be on-hook when the handset is hung up, the speakerphone is turned off, and the user is not using a headset to connect to the communications system or the telephone network.
OPT	<i>Off-Premises Telephone. Single-line telephone</i> or other <i>tip/ring</i> device connected to the system via a 008 OPT module in the control unit. Appears as an inside extension to the system, but may be physically located away from the system.
OPX	<i>Off-Premises Extension.</i>
Out-of-Band Signaling	Signaling that uses the same path as voice-frequency transmission and in which the signaling is outside the band used for voice frequencies.

P

Parity	Addition of a <i>bit</i> to a bit string so that the total number of ones is odd or even; used to detect and correct transmission errors.
PassageWay Direct Connection Solution	Set of software applications that provides an interface between a personal computer and an MLX telephone.
PBX	<i>Private Branch Exchange</i> . Local electronic telephone switch that serves local stations (for example, extensions within a business) and provides them with access to the public network.
PC	<i>Personal Computer</i> .
PCMCIA Memory Card	<i>Personal Computer Memory Card International Association Memory Card</i> . See Memory Card .
Peripheral System	In a <i>private network</i> , system that does not connect to more than one other system, sometimes called an “end node.”
Personal Line	<i>Central office</i> line/trunk that terminates directly at one or more extensions. In <i>Hybrid/PBX mode</i> , a personal line cannot be part of a line/trunk <i>pool</i> . Also called “DFT” (Direct Facility Termination).
PFT	<i>Power Failure Transfer</i> . Feature that provides continuity of telephone service during a commercial power failure by switching some of the system’s line/trunk connections to telephones connected to specially designated extension jacks.
Phantom Extension	Extension that is not actually plugged into the system, but is used, for example, as a calling group member covered by a <i>voice messaging system</i> .
Pool	In <i>Hybrid/PBX mode</i> , a group of outside lines/trunks that users can access with a Pool button or by dialing an access code on an SA <i>button</i> . Also used by the ARS feature when choosing the least expensive route for a call.
Point-to-Point Facility	In a <i>private network</i> , a line/trunk that passes through the PSTN without using the switching capabilities of the PSTN.
Port	See Jack . Also, refers to <i>extension</i> or <i>line/trunk jacks</i> before these are numbered according to the <i>dial plan</i> during programming. The lowest jack on a module is always Port 1.
Power Failure Transfer	See PFT .
Power Supply Module	Device that directs electricity to modules and telephones on the system. One power supply module is needed for each carrier, and an <i>auxiliary power unit</i> is added, if needed.

PRI	<p><i>Primary Rate Interface.</i> Standard interface that specifies the protocol used between two or more communications systems. As used in North America, it provides twenty-three 64-kbps <i>B-channels</i> for voice and/or data and one 16-kbps <i>D-channel</i>, which carries multiplexed signaling information for the other 23 channels.</p>
Primary System Operator Position	<p>First <i>jack</i> on the first MLX or analog multiline extension module in the control unit—that is, the extension jack with the lowest logical ID in the system.</p>
Prime Line	<p>Individual extension number assigned to a telephone in a system operating in <i>Behind Switch mode</i>. Each telephone user has his or her own prime line and is automatically connected to that line when he or she lifts the handset.</p>
Priority Call Queuing	<p>System function that prioritizes calling groups, thereby allowing certain incoming calls to be answered before others. Available in Release 7.0 and later systems.</p>
Private Communications Network	<p>See Private Network.</p>
Private Network	<p>Interconnected group of <i>communications systems</i>, which may consist of MERLIN LEGEND Communications Systems, DEFINITY Enterprise Communications Servers (ECS), and/or DEFINITY ProLogix Solutions.</p>
Private Network Trunks	<p>Facilities that connect <i>communications systems</i> in a <i>private network</i>. See also Tandem Tie Trunk and Tandem PRI Trunk.</p>
Processor Module	<p>Module in the second slot of the control unit (Slot 0, to the right of the <i>power supply module</i>). Includes the software and memory that runs the system.</p>
Programming Port Reassignment	<p>Reassignment of the system programming jack position to any of the first five extension jacks on the first MLX module in the control unit.</p>
Protocol	<p>Set of conventions governing the format and timing of message exchanges between devices, such as an MLX telephone and the control unit.</p>
PSTN	<p><i>Public Switched Telephone Network.</i> Network that is commonly accessible for local or long-distance calling. Also called “public network” or “public switched network.”</p>
PSTN Trunk	<p>In a <i>private network</i>, facility that connects a networked system to the <i>public switched telephone network</i>.</p>
Public switched Telephone Network	<p>See PSTN.</p>

Q

QCC *Queued Call Console.* MLX-20L telephone used by a system operator in *Hybrid/PBX mode* only. Used to answer outside calls (directed to a system operator position) and inside calls, to direct inside and outside calls to an extension or to an outside telephone number, to serve as a message center, to make outside calls for users with outward calling restrictions, to set up conference calls, and to monitor system operation.

R

RAM *Random-Access Memory.* Computer memory in which an individual *byte* or range of bytes can be addressed and read or changed without affecting other parts of memory.

Read-Only Memory See [ROM](#).

Remote Access System feature that allows an outside caller to gain access to the system, almost as if at a system extension. In a *private network*, remote access settings are used to control calls routed via *ARS* or *UDP* routing across the network.

Restore Procedure whereby saved and archived system programming is reinstated on the system, from a floppy disk or *memory card*. See also [Backup](#).

Restricted Data Channel Channels that do not allow the transmission of occurrences of more than seven contiguous zero bits. See also [Unrestricted Data Channels](#).

Ring Generator Circuit pack added to the power supply that generates a high-voltage, 20–30 Hz signal to ring a telephone.

Rotary Dial Enable Through centralized programming, T/R ports (including the T/R ports on the new ETR modules) can be programmed to accept rotary-dial and touch-tone digits or just touch-tone digits. Available in Release 7.0 and later systems.

Riser Cable Cable that runs between floors in a multi-story building and connects wiring closets.

RS-232 Physical interface, specified by the Electronics Industries Association (EIA), that transmits and receives asynchronous data at distances of up to 50 feet (15 meters).

Robbed-Bit Signaling Signaling in which the least significant *bit* of every sixth *frame* per channel is used for signaling in that channel.

ROM *Read-Only Memory.* Computer memory that can be read, but cannot be changed.

S

SAA	<i>Supplemental Alert Adapter.</i> Device that permits alerting equipment to be connected to an analog multiline telephone <i>jack</i> so that people working in noisy or remote areas of a building can be alerted to incoming calls.
SA buttons	Telephone buttons that provide access to both inside and outside calls.
Satellite System	In a <i>private network</i> , a <i>communications system</i> that is directly connected to, and located within 200 miles of the local system.
Screen Pop	Refers to a computer-telephony software application that takes caller information (for example, the calling party number provided by Caller ID service), queries a database, and displays a screen with information about the caller onto a user's PC screen. Screen pop requires that an identifying number or code be available to identify the calling party. See also CTI Link .
SDN	<i>Software Defined Network.</i> AT&T private networking service created by specialized software within the public network.
Series Configuration	<i>Private network</i> arrangement whereby either two or four or more communications systems are connected in a line, with no particular system acting as the <i>hub system</i> . See also Star Configuration .
Service Observing	Feature available in Release 6.1 and later systems that allows one extension to listen in on (observe) calls that arrive at another extension.
SID	<i>Station (Extension) Identification.</i>
Signaling	Sending of information between devices to set up, maintain, or cease a connection, such as a telephone call.
Simplex Signaling	Transmission of signals in one direction only, across a telecommunications channel.
Single-Line Telephone	Industry-standard touch-tone or rotary dial telephone that handles one call at a time. It is connected to the system via an <i>extension jack</i> on an 012 (T/R), 016 (T/R), or 008 OPT module; or, in Release 7.0 and later systems, via a <i>port</i> on a 412 LS-ID-ETR or 016 ETR module programmed for <i>tip/ring</i> operation.
Slot	Position in a carrier for a module; numbered from 0.
SMDR	<i>Station Message Detail Recording.</i> Feature that captures usage information on incoming and outgoing calls.
SMDR Printer	Printer used to produce <i>SMDR</i> reports. Connected to the system via an RS-232 <i>jack</i> on the <i>processor module</i> .

Software Defined Network	See SDN .
Special Character	Pause, Stop, or End-of-Dialing signal in a programmed dialing sequence, such as a speed dial number.
SPM	<i>System Programming and Maintenance</i> . DOS-, UNIX-, or Windows-based application for programming the system.
Square Key	Configuration in <i>Key mode</i> operation in which all outside lines appear on all telephones.
Star Configuration	<i>Private network</i> arrangement whereby either three or more communications systems are connected with one system acting as the <i>hub system</i> . See also Series Configuration .
Station	See Extension .
Station Jack	See Extension Jack .
Station Message Detail Recording	See SMDR .
Supplemental Alert Adapter	See SAA .
Switch	See Communications System .
Switched 56 Service	DS1 Switched 56 service is an end-to-end digital, 56-kbps, full-duplex, synchronous, circuit-switched service offering. The service is offered by network service providers and by some Local Exchange Carriers (LECs) as circuit-switched, 56-kbps service. T1-emulated <i>tandem tie trunks</i> in a <i>private network</i> can be programmed for data.
Switchhook Flash	Momentary (320 ms to 1 sec) on-hook signal used as a control; may be directed to the control unit or to a <i>host</i> switch outside the system. Also called "Recall" or "timed flash."
Switch Identifier	Number assigned to a <i>tandem trunk</i> in a <i>private network</i> . It identifies the system connected to the far end of the trunk. A switch identifier is based on the type of system and its distance from the system where the identifier is assigned. See also Satellite System and Non-Satellite System .
Synchronous Data Transmission	Method of transmitting a continuous digital data stream in which the transmission of each binary <i>bit</i> is synchronized with a master clock. See also Asynchronous Data Transmission .
System Acceptance Test	Test of all trunks, telephones, data terminals, and features after installation to ensure that they are working correctly.
System Access Buttons	See SA buttons .
System Date and Time	Date and time that appear on MLX display telephones and <i>SMDR</i> reports.

System Programming Programming of system functions and features that affect most users, performed from an MLX-20L telephone or a computer using *SPM*. See also [Extension Programming](#) and [Centralized Telephone Programming](#).

System Programming and Maintenance See [SPM](#).

System Renumbering Procedure used to change the numbers assigned to telephones, *adjuncts*, *calling groups*, paging groups, park zones, *Remote Access*, and lines/trunks.

T

T1 Type of digital transmission facility that, in North America, transmits at the *DS1* rate of 1.544 mbps.

T1-Emulated Data A T1 *tie trunk* programmed for S56DATA for use by data calls at speeds up to 56 kbps. These trunks may be used for tandem and non-tandem operation.

T1-Emulated Voice A T1 *tie trunk* programmed for Tie-PBX or Tie-Toll for use by voice calls.

T1 Switched 56 Service *T1* digital data transmission over the *public network* or over a *private network* at 56 kbps. See [Switched 56 Service](#).

Tandem Switching Capability of *private network* communications systems that allows them to direct outside calls from one facility to another, rather than just to an extension. Calls may be sent, for example, from a *PSTN* facility to a *tandem trunk*, or vice versa.

Tandem Trunk Private outside facility (as opposed to an inside system line) that connects two communications systems in a *private network* and can carry calls to another outside facility through *tandem switching*. The trunk is not connected to the *PSTN*.

Tandem Tie Trunk *Tandem trunk* that is an analog *delay-start tie trunk*, providing a single line/trunk per facility and allowing *analog transmission* of voice and low-speed data; or a T1 facility offering 24 channels on emulated tie trunks and programmed for voice or data.

Tandem PRI Trunk *Tandem Primary Rate Interface Trunk*. *Private network trunk*.

TAPI *Telephony Application Programming Interface*. Application programming interface that allows computer telephony applications to be used. TAPI is not yet supported by the MERLIN LEGEND Communications System. See also [TSAPI](#) and [CTI Link](#).

Telephone Power Supply Unit	Equipment that provides power to an individual telephone.
Terminal Adapter	See ISDN Terminal Adapter .
Tie Trunk	Private trunk directly connecting two telephone switches.
Timed Flash	See Switchhook Flash .
Tip/Ring	Contacts and associated conductors of a <i>single-line telephone</i> plug or jack.
Touch-Tone Receiver	See TTR .
T/R	See Tip/Ring .
Trunk	Telecommunications path between the communications system and the telephone company <i>central office</i> or another switch. Often used synonymously with <i>line</i> .
Trunk Jack	See Line/Trunk Jack .
Trunk Pool	See Pool .
TSAPI	<i>Telephony Services Application Programming Interface</i> . Application programming interface that allows computer telephony applications to be used. TSAPI is supported by the MERLIN LEGEND Communications System, Release 5.0 and later. See also TAPI and CTI Link .
TTR	<i>Touch-Tone Receiver</i> . Device used to decode <i>DTMF</i> touch-tones dialed from <i>single-line</i> or <i>Remote Access</i> telephones.

U

UDP	<i>Uniform Dial Plan</i> . Composed of the <i>local dial plan</i> and <i>non-local dial plan</i> . A dial plan that allows a caller at any <i>extension</i> in a <i>private network</i> to dial the same number of digits to reach any other extension in the private network, even if the originating extension is physically connected to one communications system and the terminating extension is physically connected to a different communications system.
Unambiguous Numbering	Practice of numbering of extension ranges, remote access codes, or other system components to avoid routing conflicts in network or local calling. For example, Extension 441 is unique when compared to Extension 4410; however, this is ambiguous, because the system routes as soon as it matches the digits sent for a call with the digits in a <i>local dial plan</i> or in a <i>non-local dial plan</i> extension range. When a caller dials 4410, therefore, the system routes the call to Extension 441 without considering the last dialed digit.
Uniform Dial Plan	See UDP .

Uninterruptible Power Supply	See UPS .
Unit Load	Measure of the power load drain of a module, telephone, or <i>adjunct</i> .
Unmonitored Extension	<i>Extension</i> for which no CTI application is receiving call information. See also CTI Link and Monitored Extension .
Unrestricted Data Channels	Also called <i>Clear Data Channels</i> . Allow the transmission of occurrences of more than seven contiguous zero bits. If an unrestricted data channel is requested and only restricted channels are available, the call will be rejected. See also Restricted Data Channel .
UPS	<i>Uninterruptible Power Supply</i> . Device that connects to the system to provide 117 VAC to the equipment when the commercial power source fails.

V

VAC	<i>Alternating Current Voltage</i> .
VDC	<i>Direct Current Voltage</i> .
VMI	<i>Voice Messaging Interface</i> . Enhanced <i>tip/ring</i> port.
Videoconferencing System	System application that allows face-to-face meetings, with voice and video, between individuals or groups. This application requires high-speed data transmission facilities. See also Desktop Videoconferencing System and Group Videoconferencing System .
Virtual Private Network	See VPN .
VPN	<i>Virtual Private Network</i> . Type of <i>private network</i> that uses the switching capabilities of the <i>PSTN</i> , rather than <i>tandem switching</i> , to direct calls between connected communications systems. A VPN may constitute a part of a private network.
Voice Announce	System feature that allows users to receive voice announcements on their telephones. In Release 7.0 and later systems, the VA On Idle Only option (only for MLX telephones) allows voice announcement calls to go through only when the telephone is idle.
Voice-Band Channel	Transmission channel, generally in the 300–3400-Hz frequency band.
Voice Mail	Application that allows users to send messages to other system extensions, to forward messages received with comments, and to reply to messages.
Voice Messaging Interface	See VMI .

W

WATS

Wide Area Telecommunications Service. Service that allows calls to certain areas for a flat-rate charge based on expected usage.

Wink-Start Tie Trunk

Tie trunk on which the originating end transmits an off-hook signal and waits for the remote end to send back a signal (a wink) that it is ready for transmission.

Index

Numerics

- 008 OPT module, [lii](#)
 - 008 OPT modules, [721](#)
 - 012 module, [lii](#)
 - 012 T/R modules
 - touch-tone receivers (TTRs), [721](#)
 - 016 T/R modules
 - touch-tone receivers (TTRs), [721](#)
 - 1 + 7 Tables, [80](#)
 - 2B data, [223](#)
 - 2-digit numbering plan, [687](#) to [689](#)
 - 2-digit numbering plan, see also System Renumbering
 - 3-digit numbering plan, [689](#) to [691](#)
 - 3-digit numbering plan, see also System Renumbering
 - 400 GS/LS modules, [721](#)
 - 408 GS/LS-MLX module, [iv](#)
 - 412 LS-ID-ETR module
 - Power-failure transfer, [507](#)
 - 5ESS, [iv](#), [102](#)
 - 6-Digit Tables, [80](#)
 - 800 DID modules, [721](#)
 - 800 GS/LS-ID modules, [721](#)
 - 800 LS-ID module, [xlvii](#)
-

A

- Abbreviated Ring, see Ringing Options
- Account Code Entry/Forced Account Code Entry, [30](#) to [36](#), [717](#)
- Account Code Entry/Forced Account Code Entry, feature interactions
 - Authorization Code, [34](#), [53](#)
 - Auto Dial, [34](#), [65](#)
 - Automatic Line Selection, [34](#), [74](#)
 - Automatic Route Selection (ARS), [34](#), [90](#)
 - Basic Rate Interface (BRI), [108](#)
 - Callback, [34](#), [119](#)
 - Conference, [34](#), [163](#)
 - Coverage, [34](#), [199](#)
 - digital data calls, [34](#), [227](#)
 - Directories, [34](#), [268](#)
 - Display, [35](#), [283](#)
 - Forward and Follow Me, [35](#), [341](#)
 - HotLine, [35](#), [406](#)
 - Paging, [476](#)
 - personal lines, [35](#), [487](#)
 - Pools, [35](#), [504](#)
 - Primary Rate Interface (PRI) and T1, [35](#), [549](#)
 - Queued Call Console (QCC), [582](#)
 - Remote Access, [35](#), [613](#)
 - Speed Dial, [35](#), [653](#)
 - Station Message Detail Recording (SMDR), [35](#), [667](#)
 - Transfer, [36](#), [733](#)
 - UDP features, [36](#), [749](#)

Administration, see Programming

Alarm, [37](#) to [39](#)

Alarm Clock, [40](#) to [41](#)

Alarm Clock, feature interactions

Display, [284](#)

language choice, [41](#), [422](#)

Alarm, feature interactions

Automatic Maintenance Busy, [38](#), [76](#)

Computer Telephony Integration (CTI) link, [38](#), [220](#)

Direct-Line Console, [38](#)

Direct-Line Console (DLC), [235](#)

Inspect, [38](#), [411](#)

Night Service, [39](#), [466](#)

personal lines, [39](#), [487](#)

Pools, [39](#), [504](#)

Queued Call Console (QCC), [582](#)

UDP features, [39](#), [749](#)

Allowed Lists, see Allowed/Disallowed Lists

Allowed/Disallowed Lists, [42](#) to [48](#)

Allowed/Disallowed Lists, feature interactions

Auto Dial, [46](#), [65](#)

Automatic Route Selection (ARS), [46](#), [91](#)

calling restrictions, [46](#), [137](#)

Conference, [46](#), [163](#)

Direct-Line Console (DLC), [235](#)

Directories, [47](#), [268](#)

Extension Status, [321](#)

Forward and Follow Me, [47](#), [341](#)

Hold, [400](#)

HotLine, [47](#), [406](#)

Night Service, [47](#)

personal lines, [47](#), [488](#)

Queued Call Console (QCC), [582](#)

Recall/Timed Flash, [47](#), [594](#)

Remote Access, [47](#), [613](#)

Speed Dial, [48](#), [653](#)

tandem switching, [48](#), [709](#)

Toll Type, [48](#), [715](#)

ALS, see Automatic Line Selection and Ringing/Idle Line Preference

Analog Multiline Telephones

Account Code Entry, [33](#)

Analog multiline telephones

Display information, [282](#)

Area code tables, [80](#)

Area code tables, see also Automatic Route Selection (ARS)

ARS, see Automatic Route Selection (ARS)

Attendant Barge-In, see Barge-In

Attendant console—Switched Loop, see Queued Call Console (QCC)

Attendant DSS, see Direct Station Selector (DSS)

Attendant Message Waiting, see Messaging

AUDIX Voice Power, [liv](#), [153](#), [319](#), [372](#), [696](#), [717](#) to [721](#)

Authorization Code, [49](#) to [55](#), [717](#)

Authorization Code, feature interactions

Account Code Entry/Forced Account Code Entry, [34](#), [53](#)

Automatic Route Selection (ARS), [53](#), [91](#)

Centrex operation, [156](#)

Conference, [54](#), [163](#)

digital data calls, [54](#), [227](#)

Display, [284](#)

Forward and Follow Me, [54](#), [342](#)

Authorization Code, feature interactions, (continued)

- Headset options, [54](#), [393](#)
- Hold, [54](#), [400](#)
- Last Number Dial, [54](#), [425](#)
- Night Service, [54](#), [466](#)
- Park, [55](#), [482](#)
- Queued Call Console (QCC), [582](#)
- Remote Access, [55](#), [614](#)
- Saved Number Dial, [55](#), [628](#)
- Speed Dial, [55](#), [653](#)
- Station Message Detail Recording (SMDR), [55](#), [667](#)
- System Renumbering, [55](#), [696](#)
- Transfer, [55](#), [733](#)

Authorization Codes, [xlviii](#)

Auto Answer All, [56](#) to [58](#)

Auto Answer All, feature interactions

- Auto Answer Intercom, [57](#), [60](#)
- Auto Dial, [57](#), [65](#)
- Coverage, [58](#), [199](#)
- Forward and Follow Me, [58](#), [342](#)
- Group Calling, [58](#), [380](#)
- Queued Call Console (QCC), [582](#)
- Ringing Options, [58](#), [623](#)
- System Access/Intercom buttons, [58](#), [679](#)
- Voice Announce, [58](#)

Auto Answer Intercom, [59](#) to [61](#)

Auto Answer Intercom, feature interactions

- Auto Answer All, [57](#), [60](#)
- Coverage, [60](#), [199](#)
- Queued Call Console (QCC), [582](#)
- System Access/Intercom buttons, [60](#), [679](#)
- UDP features, [61](#), [749](#)

Auto Dial, [62](#) to [68](#)

- across a private network, [63](#)

Auto Dial button, [I](#)

Auto Dial, feature interactions

- Account Code Entry/Forced Account Code Entry, [34](#), [65](#)
- Allowed/Disallowed Lists, [46](#), [65](#)
- Auto Answer All, [57](#), [65](#)
- Automatic Route Selection (ARS), [65](#), [91](#)
- calling restrictions, [137](#)
- Conference, [65](#), [163](#)
- digital data calls, [65](#), [227](#)
- Direct-Line Console (DLC), [235](#)
- Display, [66](#), [284](#)
- Do Not Disturb, [66](#), [313](#)
- Forward and Follow Me, [66](#), [342](#)
- Group Calling, [66](#), [380](#)
- Headset options, [66](#), [393](#)
- Hold, [66](#), [400](#)
- Last Number Dial, [66](#), [425](#)
- Microphone Disable, [66](#), [445](#)
- Paging, [66](#), [476](#)
- Park, [66](#), [482](#)
- personal lines, [66](#), [488](#)
- Pools, [67](#), [505](#)
- Queued Call Console (QCC), [582](#)
- Recall/Timed Flash, [67](#), [594](#)
- Saved Number Dial, [67](#), [628](#)
- Signal/Notify, [67](#), [639](#), [647](#)

- Auto Dial, feature interactions, (continued)
 - Station Message Detail Recording (SMDR), [67](#), [667](#)
 - System Access/Intercom buttons, [68](#)
 - Transfer, [68](#), [733](#)
 - UDP features, [68](#), [749](#)
- Auto intercom, see Auto Answer Intercom
- Auto Login/Logout, see Group Calling
- Automatic Callback, [117](#)
- Automatic Callback, see also Callback
- Automatic Completion, see Transfer
- Automatic Hold or Release, see Queued Call Console (QCC)
- Automatic Line Selection and Ringing/Idle Line Preference, [69](#) to [74](#)
- Automatic Line Selection, feature interactions
 - Account Code Entry/Forced Account Code Entry, [34](#), [74](#)
 - Coverage, [74](#), [199](#)
 - Headset options, [74](#), [393](#)
 - Multi-Function Module (MFM), [74](#), [451](#)
 - Queued Call Console (QCC), [582](#)
 - Ringling Options, [74](#), [623](#)
 - System Access/Intercom buttons, [74](#), [679](#)
 - Transfer, [74](#), [733](#)
- Automatic Maintenance Busy, [75](#) to [76](#)
- Automatic Maintenance Busy, feature interactions
 - Alarm, [38](#), [76](#)
 - Automatic Route Selection (ARS), [76](#), [91](#)
 - Pools, [76](#), [505](#)
- Automatic Route Selection (ARS), [77](#) to ??
 - access code, [744](#)
- Automatic Route Selection (ARS), feature interactions
 - Account Code Entry/Forced Account Code Entry, [34](#), [90](#)
 - Allowed/Disallowed Lists, [46](#), [91](#)
 - Authorization Code, [53](#), [91](#)
 - Auto Dial, [65](#), [91](#)
 - Automatic Maintenance Busy, [76](#), [91](#)
 - Callback, [91](#), [119](#)
 - calling restrictions, [91](#), [137](#)
 - digital data calls, [91](#), [227](#)
 - Direct Station Selector (DSS), [91](#), [253](#)
 - Directories, [91](#), [268](#)
 - Display, [92](#), [285](#)
 - Forward and Follow Me, [92](#), [342](#)
 - HotLine, [92](#), [406](#)
 - Night Service, [92](#), [466](#)
 - Pools, [92](#), [505](#)
 - Primary Rate Interface (PRI) and T1, [92](#), [549](#)
 - Recall/Timed Flash, [92](#), [595](#)
 - Remote Access, [93](#), [614](#)
 - Saved Number Dial, [93](#), [628](#)
 - Speed Dial, [93](#), [653](#)
 - Station Message Detail Recording (SMDR), [93](#), [667](#)
 - System Access/Intercom buttons, [93](#), [680](#)
 - System Renumbering, [93](#), [696](#)
 - tandem switching, [93](#), [709](#)
 - Toll Type, [94](#), [715](#)
- Automatic Route Selection (ARS), see also Facility Restriction Levels (FRLs)
- Autoqueuing, see Callback

B

- Barge-In, [95](#) to [98](#)
- Barge-In, feature interactions
 - Basic Rate Interface (BRI), [96](#), [108](#)
 - Callback, [96](#), [119](#)
 - Conference, [96](#), [164](#)
 - Coverage, [96](#), [200](#)
 - digital data calls, [96](#), [227](#)
 - Direct Station Selector (DSS), [97](#), [253](#)
 - Display, [97](#), [285](#)
 - Do Not Disturb, [97](#), [313](#)
 - Forward and Follow Me, [97](#), [342](#)
 - Group Calling, [97](#), [380](#)
 - Headset options, [97](#), [393](#)
 - HotLine, [97](#), [406](#)
 - Messaging, [97](#), [441](#)
 - Paging, [97](#), [476](#)
 - Primary Rate Interface (PRI) and T1, [550](#)
 - Privacy, [98](#), [555](#)
 - Queued Call Console (QCC), [582](#)
 - Recall/Timed Flash, [98](#), [595](#)
 - UDP features, [98](#), [749](#)
- Barrier codes, [xlviii](#), [610](#) to [612](#)
- Barrier codes, see also Remote Access
- Basic Rate Interface (BRI), [99](#) to [109](#)
- Basic Rate Interface (BRI), feature interactions
 - Account Code Entry/Forced Account Code Entry, [108](#)
 - Barge-In, [96](#), [108](#)
 - Call Waiting, [108](#), [113](#)
 - Conference, [108](#), [164](#)
 - Hold, [108](#), [400](#)
 - Recall/Timed Flash, [108](#), [595](#)
 - Remote Access, [109](#)
 - Station Message Detail Recording (SMDR), [109](#), [668](#)
 - Transfer, [109](#), [733](#)
- Behind Switch mode, see Centrex operation, Recall/Timed Flash
- BRI, see Basic Rate Interface (BRI)
- Bridging, see Personal lines, System Access/Intercom buttons
- Business Cordless 905 Telephone, [I-34](#)
- Button diagrams, see Appendix G

C

- Call Accounting System (CAS), [152](#), [153](#), [613](#), [655](#), [656](#)
- Call Accounting System (CAS), see also Appendix I
- Call Accounting Terminal (CAT), [152](#), [656](#)
- Call Accounting Terminal (CAT), see also Appendix I
- Call completion, see Transfer
- Call Coverage, see Coverage
- Call Forward, see Forward and Follow Me
- Call Management System (CMS), [153](#), [232](#), [233](#), [236](#), [240](#), [317](#) to [321](#), [375](#), [376](#), [450](#), [548](#)
- Call Park, see Park
- Call Pickup, see Pickup
- Call records, see Station Message Detail Recording (SMDR)

Call Waiting, [110](#) to [115](#)

Call Waiting, feature interactions

Basic Rate Interface (BRI), [108](#), [113](#)

Callback, [113](#), [120](#)

Camp-On, [113](#), [142](#)

Conference, [113](#), [164](#)

Coverage, [113](#), [200](#)

digital data calls, [113](#), [227](#)

Direct-Line Console (DLC), [236](#)

Display, [114](#), [288](#)

Forward and Follow Me, [114](#), [343](#)

Group Calling, [114](#), [381](#)

Hold, [114](#), [400](#)

HotLine, [114](#), [406](#)

Paging, [114](#), [476](#)

personal lines, [114](#), [488](#)

Pickup, [114](#), [497](#)

Primary Rate Interface (PRI) and T1, [114](#), [550](#)

Recall/Timed Flash, [115](#), [595](#)

Reminder service, [115](#), [601](#)

Station Message Detail Recording (SMDR), [115](#), [668](#)

System Access/Intercom buttons, [115](#), [680](#)

Transfer, [115](#), [734](#)

Callback

Automatic, [117](#)

description, [116](#) to [124](#)

Selective, [117](#)

Callback, feature interactions

Account Code Entry/Forced Account Code Entry, [34](#), [119](#)

Automatic Route Selection (ARS), [91](#), [119](#)

Barge-In, [96](#), [119](#)

Call Waiting, [113](#), [120](#)

calling restrictions, [120](#), [137](#)

Conference, [120](#), [164](#)

Coverage, [120](#), [200](#)

digital data calls, [120](#), [227](#)

Display, [120](#), [286](#)

Do Not Disturb, [121](#), [313](#)

Extension Status, [121](#), [321](#)

Forward and Follow Me, [121](#), [342](#)

Group Calling, [122](#), [380](#)

Headset options, [122](#), [393](#)

Hold, [122](#), [400](#)

HotLine, [122](#), [406](#)

Line Request, [122](#), [428](#)

Multi-Function Module (MFM), [122](#), [451](#)

Music On Hold, [122](#), [457](#)

Paging, [122](#), [476](#)

Park, [122](#), [482](#)

personal lines, [122](#), [488](#)

Pickup, [122](#), [497](#)

Pools, [123](#), [505](#)

Primary Rate Interface (PRI) and T1, [123](#), [550](#)

Queued Call Console (QCC), [582](#)

Recall/Timed Flash, [123](#), [595](#)

Reminder service, [123](#), [601](#)

Remote Access, [123](#), [614](#)

Speed Dial, [123](#), [653](#)

Station Message Detail Recording (SMDR), [123](#), [668](#)

System Access/Intercom buttons, [123](#), [680](#)

- Callback, feature interactions, (continued)
 - tandem switching, [709](#)
 - Transfer, [124](#), [733](#)
 - UDP features, [124](#), [750](#)
- Call-by-Call Service Selection, [537](#) to [541](#)
- Call-by-Call Services Table, see Primary Rate Interface (PRI) and T1
- Called Party Number (CdPN), [102](#), [515](#)
- Caller ID, [125](#) to [131](#)
 - across a private network, [131](#)
- Caller ID toggle button, [125](#)
- Caller ID, feature interactions
 - Centrex operation, [156](#)
 - Conference, [129](#), [164](#)
 - Coverage, [129](#), [200](#)
 - Display, [129](#), [290](#), [304](#)
 - Do Not Disturb, [129](#), [313](#)
 - Forward and Follow Me, [129](#), [343](#)
 - Group Calling, [130](#), [381](#)
 - Headset options, [130](#), [393](#)
 - Night Service, [130](#), [466](#)
 - personal lines, [130](#), [488](#)
 - Pools, [130](#), [505](#)
 - Remote Access, [130](#), [614](#)
 - Ringing Options, [130](#), [623](#)
 - Station Message Detail Recording (SMDR), [130](#), [668](#)
 - System Access/Intercom buttons, [131](#), [680](#)
 - Transfer, [131](#), [733](#)
 - UDP features, [131](#), [750](#)
- Calling group
 - non-local member, [354](#)
- Calling Group Priority, [360](#)
- Calling group supervisor, [358](#) to [360](#)
- Calling group, see Group Calling
- Calling Party Number
 - BRI lines vs. Caller ID, [103](#)
- Calling Party Number (CPN), [103](#), [515](#)
- Calling restrictions, [132](#) to [139](#), [376](#)
- Calling restrictions, feature interactions
 - Allowed/Disallowed Lists, [46](#), [137](#)
 - Auto Dial, [137](#)
 - Automatic Route Selection (ARS), [91](#), [137](#)
 - Callback, [120](#), [137](#)
 - Centrex operation, [137](#), [156](#)
 - Conference, [138](#), [164](#)
 - Coverage, [138](#), [200](#)
 - Direct-Line Console (DLC), [235](#)
 - Directories, [138](#), [268](#)
 - Display, [138](#), [287](#)
 - Extension Status, [138](#), [321](#)
 - Forward and Follow Me, [138](#), [341](#)
 - HotLine, [138](#), [406](#)
 - Night Service, [138](#), [466](#)
 - personal lines, [139](#), [488](#)
 - Pools, [139](#), [505](#)
 - Primary Rate Interface (PRI) and T1, [139](#), [550](#)
 - Queued Call Console (QCC), [582](#)
 - Recall/Timed Flash, [47](#), [139](#), [594](#)
 - Speed Dial, [139](#), [653](#)
 - System Access/Intercom buttons, [139](#), [680](#)
 - UDP features, [139](#), [750](#)

Calls-in-Queue Alarm, see Group Calling, Queued Call Console (QCC)

Camp-On, [140](#) to [143](#)

Camp-On, feature interactions

Call Waiting, [113](#), [142](#)

Coverage, [142](#), [200](#)

digital data calls, [142](#), [228](#)

Direct Station Selector (DSS), [142](#), [253](#)

Direct-Line Console (DLC), [236](#)

Display, [142](#), [288](#)

Do Not Disturb, [142](#), [313](#)

Forward and Follow Me, [143](#), [343](#)

Group Calling, [143](#), [381](#)

Line Request, [143](#), [428](#)

Music On Hold, [143](#), [457](#)

Paging, [143](#), [476](#)

Primary Rate Interface (PRI) and T1, [550](#)

Queued Call Console (QCC), [583](#)

Station Message Detail Recording (SMDR), [143](#), [668](#)

System Access/Intercom buttons, [143](#)

Transfer, [143](#), [734](#)

UDP features, [143](#), [750](#)

Canadian Department of Communications (DOC), see Appendix A

CAS for Windows, see Call Accounting System (CAS), Appendix I

CAT, see Call Accounting Terminal (CAT), Appendix I

Centralized telephone programming, [564](#)

Centralized telephone programming, see also Programming

Centralized Voice Messaging, [144](#), [C-2](#)

interaction with Coverage, [200](#)

interaction with Direct Voice Mail, [262](#)

interaction with Group Calling, [381](#)

interaction with Leave Word Calling, [441](#)

interaction with Night Service, [466](#)

Centrex operation

description, [145](#) to [157](#)

full, [146](#) to [147](#)

limited, [148](#)

Centrex Operation, feature interactions

Authorization Code, [54](#)

Centrex operation, feature interactions

Authorization Code, [156](#)

Caller ID, [156](#)

calling restrictions, [137](#), [156](#)

Conference, [156](#), [165](#)

Forward and Follow Me, [156](#)

Group Calling, [156](#)

Recall/Timed Flash, [156](#)

Speed Dial, [157](#)

Station Message Detail Recording (SMDR), [157](#)

Transfer, [157](#)

Centrex Transfer via Remote Call Forwarding, [149](#) to [151](#), [329](#) to [331](#)

Channel service unit (CSU), [525](#) to [526](#)

Class of Restriction, see Remote Access

Clock switching, [104](#)

Clock synchronization, [103](#) to [104](#)

CMS, see Call Management System (CMS)

Collected digits, [213](#)

Computer Telephony Integration (CTI) link, [208](#) to [222](#)

Computer Telephony Integration (CTI) link, feature interactions

- Alarm, [38](#), [220](#)
- Conference, [165](#), [220](#)
- Coverage, [200](#), [220](#)
- digital data calls, [220](#), [228](#)
- Direct-Line Console (DLC), [236](#)
- Directories, [221](#), [268](#)
- Forward and Follow Me, [221](#), [344](#)
- Group Calling, [221](#), [382](#)
- Hold, [221](#), [400](#)
- personal lines, [221](#), [489](#)
- Pools, [221](#), [505](#)
- Queued Call Console (QCC), [584](#)
- System Access/Intercom buttons, [222](#), [681](#)
- System Renumbering, [222](#), [696](#)
- Transfer, [222](#), [734](#)
- UDP features, [222](#), [751](#)

Computer Telephony Integration (CTI) link, feature interactionstandem switching, [710](#)

Computer telephony integration, see Computer Telephony Integration (CTI) link

Conference, [158](#) to [169](#)

- in Behind Switch mode, [146](#)

Conference, feature interactions

- Account Code Entry/Forced Account Code Entry, [34](#), [163](#)
- Allowed/Disallowed Lists, [46](#), [163](#)
- Authorization Code, [54](#), [163](#)
- Auto Dial, [65](#), [163](#)
- Barge-In, [96](#), [164](#)
- Basic Rate Interface (BRI), [108](#), [164](#)
- Call Waiting, [113](#), [164](#)
- Callback, [120](#), [164](#)
- Caller ID, [129](#), [164](#)
- calling restrictions, [138](#), [164](#)
- Centrex operation, [156](#), [165](#)

Computer Telephony Integration (CTI) link, [165](#), [220](#)

- Coverage, [165](#), [200](#)
- digital data calls, [165](#), [228](#)
- Directories, [165](#), [268](#)
- Display, [166](#), [289](#)
- Fax Extension, [166](#), [324](#)
- Forward and Follow Me, [166](#), [343](#)
- Group Calling, [166](#), [381](#)
- Headset options, [166](#), [393](#)
- Hold, [167](#), [400](#)
- HotLine, [167](#), [406](#)
- Inspect, [167](#), [411](#)
- Multi-Function Module (MFM), [167](#), [452](#)
- Music On Hold, [167](#), [457](#)
- Paging, [167](#), [476](#)
- Park, [167](#), [482](#)
- Pickup, [168](#), [497](#)
- Primary Rate Interface (PRI) and T1, [550](#)
- Queued Call Console (QCC), [583](#)
- Recall/Timed Flash, [168](#), [595](#)
- Remote Access, [168](#), [614](#)
- Signal/Notify, [169](#), [639](#), [647](#)
- Speed Dial, [169](#), [653](#)
- Station Message Detail Recording (SMDR), [169](#), [668](#)
- System Access/Intercom buttons, [169](#), [680](#)
- Transfer, [169](#), [734](#)
- UDP features, [750](#)

- Consultation, see Transfer, Conference
- Control unit
 - cover, [li](#)
- CONVERSANT, [717](#)
- CONVERSANT, see also Appendix I
- Coverage, [liv](#), [170](#) to [207](#)
 - across a private network, [C-2](#)
 - to a QCC across a private network, [177](#)
- Coverage delay options, [174](#) to [176](#)
- Coverage VMS, [liv](#)
- Coverage, feature interactions
 - Account Code Entry/Forced Account Code Entry, [34](#), [199](#)
 - Auto Answer All, [58](#), [199](#)
 - Auto Answer Intercom, [60](#), [199](#)
 - Automatic Line Selection, [74](#), [199](#)
 - Barge-In, [96](#), [200](#)
 - Call Waiting, [113](#), [200](#)
 - Callback, [120](#), [200](#)
 - Caller ID, [129](#), [200](#)
 - calling restrictions, [138](#), [200](#)
 - Camp-On, [142](#), [200](#)
 - Computer Telephony Integration (CTI) link, [200](#), [220](#)
 - Conference, [165](#), [200](#)
 - digital data calls, [201](#), [228](#)
 - Direct Station Selector (DSS), [201](#), [253](#)
 - Direct Voice Mail, [201](#), [262](#)
 - Direct-Line Console (DLC), [236](#)
 - Display, [201](#), [290](#)
 - Do Not Disturb, [202](#), [313](#)
 - Forward and Follow Me, [202](#), [343](#)
 - Group Calling, [203](#), [381](#)
 - Hold, [204](#), [400](#)
 - HotLine, [204](#), [406](#)
 - Multi-Function Module (MFM), [204](#), [452](#)
 - Night Service, [204](#), [462](#) to [463](#), [466](#)
 - Park, [204](#), [482](#)
 - personal lines, [205](#), [488](#)
 - Pickup, [205](#), [498](#)
 - Pools, [205](#), [505](#)
 - Primary Rate Interface (PRI) and T1, [550](#)
 - Queued Call Console (QCC), [583](#)
 - Recall/Timed Flash, [205](#), [595](#)
 - Reminder service, [205](#), [601](#)
 - Ringing Options, [206](#), [623](#)
 - Station Message Detail Recording (SMDR), [206](#), [668](#)
 - System Access/Intercom buttons, [207](#), [680](#)
 - Transfer, [207](#), [734](#)
 - UDP features, [207](#), [751](#)
 - Voice Announce to Busy, [207](#), [760](#)
- CSU, see Channel service unit (CSU)
- CTI Link
 - operator positions, [216](#)
 - Platform Requirements, [209](#)
- CTI link, see Computer Telephony Integration (CTI) ink
- Customer support, see Appendix A

D

- Data Privacy, see Privacy
- Data transmission, see Digital data calls
- Date and time, [291](#)
- DEFINITY Enterprise Communications Server (ECS) and DEFINITY ProLogix Solutions
 - non-local Uniform Dial Plan (UDP), [745](#)
- Delay Announcement, see Group Calling
- Delay Ring, see Ringing Options
- DFT (Direct Facility Termination), see Personal lines
- Dial 0 Table, [81](#)
- Dial by name, see Directories
- Dial Plan Routing Table, see Primary Rate Interface (PRI) and T1
- Dial plan, see System Renumbering
- Dial Tone, see Inside Dial Tone
- Digit absorption, [705](#)
- Digital Announcer Unit, [lii](#)
- Digital data calls, [223](#) to [230](#)
- Digital data calls, feature interactions
 - Account Code Entry/Forced Account Code Entry, [34](#), [227](#)
 - Authorization Code, [54](#), [227](#)
 - Auto Dial, [65](#), [227](#)
 - Automatic Route Selection (ARS), [91](#), [227](#)
 - Barge-In, [96](#), [227](#)
 - Call Waiting, [113](#), [227](#)
 - Callback, [120](#), [227](#)
 - Camp-On, [142](#), [228](#)
 - Computer Telephony Integration (CTI) link, [220](#), [228](#)
 - Conference, [165](#), [228](#)
 - Coverage, [201](#), [228](#)
 - Directories, [228](#), [269](#)
 - Do Not Disturb, [228](#), [313](#)
 - Forward and Follow Me, [228](#), [344](#)
 - Group Calling, [228](#), [382](#)
 - Hold, [228](#)
 - Last Number Dial, [229](#), [425](#)
 - Messaging, [229](#), [441](#)
 - Multi-Function Module (MFM), [229](#), [452](#)
 - Night Service, [229](#), [466](#)
 - Paging, [229](#), [476](#)
 - Park, [229](#), [482](#)
 - personal lines, [229](#), [489](#)
 - Pickup, [229](#), [498](#)
 - Pools, [229](#), [505](#)
 - Privacy, [230](#), [555](#)
 - Reminder service, [230](#), [601](#)
 - Remote Access, [230](#), [614](#)
 - Ringing Options, [230](#), [623](#)
 - Signal/Notify, [230](#), [647](#)
 - Speed Dial, [230](#), [653](#)
 - System Access/Intercom buttons, [230](#), [681](#)
 - tandem switching, [230](#), [710](#)
 - Transfer, [230](#), [735](#)
 - Voice Announce to Busy, [230](#), [760](#)
- Digital Signal 1 (DS1), see Primary Rate Interface (PRI) and T1
- Digital Subscriber Line (DSL), [101](#)
- Digits in Extension, see System Renumbering

- Direct Department Calling, see Group Calling
- Direct facility termination (DFT), see Personal lines
- Direct Group Calling, see Group Calling
- Direct Inward Dial (DID) trunks, [lv](#)
- Direct Inward System Access (DISA), see Remote Access
- Direct Station Selector (DSS), [l](#), [240 to 259](#), [560 to 561](#), [694 to 695](#)
- Direct Station Selector (DSS), feature interactions
 - Automatic Route Selection (ARS), [91](#), [253](#)
 - Barge-In, [97](#), [253](#)
 - Camp-On, [142](#), [253](#)
 - Coverage, [201](#), [253](#)
 - Direct Voice Mail, [254](#), [262](#)
 - Display, [254](#), [291](#)
 - Do Not Disturb, [254](#), [313](#)
 - Extension Status, [254](#), [321](#)
 - Forward and Follow Me, [254](#), [344](#)
 - Group Calling, [254](#), [382](#)
 - Hold, [255](#), [401](#)
 - Inspect, [256](#), [412](#)
 - Last Number Dial, [256](#), [425](#)
 - Messaging, [256](#), [441](#)
 - Paging, [256](#), [476](#)
 - Park, [257](#), [482](#)
 - Pickup, [257](#), [498](#)
 - Saved Number Dial, [258](#), [628](#)
 - Signal/Notify, [258](#), [647](#)
 - System Renumbering, [258](#), [696](#)
 - Transfer, [259](#), [735](#)
 - UDP features, [259](#)
- Direct Station Selector, feature interactions
 - Headset options, [393](#)
- Direct Voice Mail, [260 to 262](#)
- Direct Voice Mail, feature interactions
 - Coverage, [201](#), [262](#)
 - Direct Station Selector (DSS), [254](#), [262](#)
 - Forward and Follow Me, [262](#), [345](#)
 - Headset options, [262](#), [393](#)
 - Queued Call Console (QCC), [584](#)
 - Transfer, [262](#), [735](#)
 - UDP features, [752](#)
- Direct-Line Console (DLC), [231 to 239](#)
- Direct-Line Console (DLC), feature interactions
 - Alarm, [235](#)
 - Allowed/Disallowed Lists, [235](#)
 - Auto Dial, [235](#)
 - Call Waiting, [236](#)
 - calling restrictions, [235](#)
 - Camp-On, [236](#)
 - Computer Telephony Integration (CTI) link, [236](#)
 - Coverage, [236](#)
 - Directories, [236](#)
 - Do Not Disturb, [236](#)
 - Extension Status, [236](#)
 - Forward and Follow Me, [237](#)
 - Group Calling, [237](#)
 - Hold, [237](#)
 - Messaging, [237](#)
 - Multi-Function Module (MFM), [237](#)
 - Night Service, [238](#)
 - Paging, [238](#)

Direct-Line Console (DLC), feature interactions, (continued)

- Park, [238](#)
- personal lines, [238](#)
- Pickup, [238](#)
- Pools, [238](#)
- Reminder service, [238](#)
- Remote Access, [238](#)
- Speed Dial, [239](#)
- System Access/Intercom buttons, [239](#)
- Transfer, [239](#)
- UDP features, [239](#)

Direct-Line Console, feature interactions

- Allowed/Disallowed Lists, [46](#)
- Auto Dial, [65](#)
- Call Waiting, [114](#)
- Camp-On, [142](#)
- Coverage, [201](#)

Directories

- description, [263](#) to [270](#)
- Extension, [265](#)
- Personal, [265](#) to [266](#)
- security, [267](#)
- System, [264](#) to [265](#)

Directories, feature interactions

- Account Code Entry/Forced Account Code Entry, [34](#), [268](#)
- Allowed/Disallowed Lists, [47](#), [268](#)
- Automatic Route Selection (ARS), [91](#), [268](#)
- calling restrictions, [138](#), [268](#)
- Computer Telephony Integration (CTI) link, [221](#), [268](#)
- Conference, [165](#), [268](#)
- digital data calls, [228](#), [269](#)
- Direct-Line Console (DLC), [236](#)
- Display, [269](#), [291](#)
- Drop, [269](#)
- Hold, [269](#), [401](#)
- Labeling, [269](#), [416](#)
- Last Number Dial, [269](#), [425](#)
- Messaging, [269](#), [441](#)
- personal lines, [269](#), [489](#)
- Pools, [269](#), [505](#)
- Queued Call Console (QCC), [584](#)
- Recall/Timed Flash, [269](#), [595](#)
- Saved Number Dial, [269](#), [628](#)
- Second Dial Tone Timer, [269](#), [631](#)
- Speed Dial, [270](#), [653](#)
- UDP features, [270](#), [752](#)

Directory Number (DN), [101](#)

DISA, see Remote Access

Disallowed List, Default, [45](#)

Disallowed Lists, see Allowed/Disallowed Lists

Display, [271](#) to [310](#)

Display, feature interactions

- Account Code Entry/Forced Account Code Entry, [35](#), [283](#)
- Alarm Clock, [284](#)
- Authorization Code, [284](#)
- Auto Dial, [66](#), [284](#)
- Automatic Route Selection (ARS), [92](#), [285](#)
- Barge-In, [97](#), [285](#)
- Call Waiting, [114](#), [288](#)
- Callback, [120](#), [286](#)

Display, feature interactions, (continued)

- Caller ID, [129](#), [290](#), [304](#)
- calling restrictions, [138](#), [287](#)
- Camp-On, [142](#), [288](#)
- Conference, [166](#)
- Coverage, [201](#), [290](#)
- Date and time, [291](#)
- Direct Station Selector (DSS), [254](#), [291](#)
- Directories, [269](#), [291](#)
- Do Not Disturb, [292](#), [314](#)
- Extension Status, [293](#)
- Fax Extension, [293](#), [324](#)
- Forward, [289](#)
- Forward and Follow Me, [294](#), [345](#)
- Group Calling, [295](#), [383](#)
- Hold, [296](#), [401](#)
- Inspect, [297](#), [410](#) to [412](#)
- Last Number Dial, [297](#), [425](#)
- Messaging, [298](#), [441](#)
- Night Service, [299](#), [467](#)
- Paging, [300](#), [476](#)
- Park, [300](#), [482](#)
- Pickup, [301](#), [498](#)
- Pools, [302](#), [505](#)
- Primary Rate Interface (PRI) and T1, [290](#), [304](#)
- Privacy, [302](#), [555](#)
- Queued Call Console (QCC), [585](#)
- Recall/Timed Flash, [302](#), [596](#)
- Reminder service, [303](#)
- Remote Access, [304](#), [614](#)
- Saved Number Dial, [305](#), [629](#)
- System Access/Intercom buttons, [305](#), [681](#)
- System Speed Dial, [305](#)
- Timer, [306](#)
- Transfer, [306](#), [735](#)
- UDP features, [752](#)

Distinctive Ringing, see Ringing Options

DMS-100 services, [102](#)

Do Not Disturb, [liv](#), [311](#) to [315](#)

Do Not Disturb, feature interactions

- Auto Dial, [66](#), [313](#)
- Barge-In, [97](#), [313](#)
- Callback, [121](#), [313](#)
- Caller ID, [129](#), [313](#)
- Camp-On, [142](#), [313](#)
- Coverage, [202](#), [313](#)
- digital data calls, [228](#), [313](#)
- Direct Station Selector (DSS), [254](#), [313](#)
- Direct-Line Console (DLC), [236](#)
- Display, [292](#), [314](#)
- Extension Status, [321](#)
- Forward and Follow Me, [314](#), [345](#)
- Group Calling, [314](#), [383](#)
- Headset options, [314](#), [393](#)
- Labeling, [314](#), [416](#)
- Messaging, [314](#), [442](#)
- Multi-Function Module (MFM), [315](#), [452](#)
- Paging, [315](#), [477](#)
- Queued Call Console (QCC), [585](#)
- Reminder service, [315](#), [601](#)

Do Not Disturb, feature interactions, (continued)
 Signal/Notify, [315](#), [641](#), [647](#)
 System Access/Intercom buttons, [315](#), [681](#)
 Transfer, [315](#), [736](#)
 Voice Announce to Busy, [315](#), [760](#)
DOC, Canada, see Appendix A
DPT, see Pools
Drop
 in Behind Switch mode, [146](#)
Drop button
 Centrex operation, [156](#), [165](#)
Drop, feature interactions
 Directories, [269](#)
 Inspect, [412](#)
 Speed Dial, [653](#)
Drop, see also Conference
Drop-and-insert equipment, [528](#)
DS1, see Primary Rate Interface (PRI) and T1
DSS
 non-local extensions, [239](#)
DSS, see Direct Station Selector (DSS)

E

Enhanced Service Center, [I-4](#)
Enhanced Service Center, see MERLIN LEGEND Enhanced Service Center., [I-16](#)
ETR Drop button, [151](#)
ETR telephone display, [272](#)
ETR telephones
 Account Code Entry, [33](#)
 Display information, [281](#)
EWSD, [102](#)
Executive Barge-in, see Barge-In
Extended call completion, see Queued Call Console (QCC)
Extension Directory, [265](#)
Extension Directory, see also Directories
Extension language, [419](#)
Extension Pickup, see Pickup
Extension programming, [564](#)
Extension programming, see also Programming, Appendix D
Extension Status, [317](#) to [321](#)
Extension Status, feature interactions
 Allowed/Disallowed Lists, [321](#)
 Callback, [121](#), [321](#)
 calling restrictions, [138](#), [321](#)
 Direct Station Selector (DSS), [254](#), [321](#)
 Direct-Line Console (DLC), [236](#)
 Display, [293](#)
 Do Not Disturb, [321](#)
 Group Calling, [321](#), [383](#)
 HotLine, [321](#), [406](#)
 Queued Call Console (QCC), [585](#)

F

- Facility Restriction Levels (FRLs), [80](#), [88](#) to [89](#), [134](#) to [135](#)
 - extensions, [706](#)
- Facility Restriction Levels (FRLs), see also Automatic Route Selection (ARS)
- Fax Extension, [322](#) to [324](#)
- Fax Extension, feature interactions
 - Conference, [166](#), [324](#)
 - Display, [293](#), [324](#)
 - Group Calling, [324](#), [383](#)
 - Hold, [324](#), [401](#)
 - Messaging, [324](#), [442](#)
 - Multi-Function Module (MFM), [324](#), [452](#)
 - Ringing Options, [324](#), [624](#)
 - Transfer, [324](#), [736](#)
- Fax message waiting, see Messaging
- FCC (Federal Communications Commission), see Appendix A
- FCC registration
 - PF registration number, [lvii](#)
- Feature feedback, see Display
- Features, list, see Appendix C
- Features, using, see entries by name, Appendix D
- Federal Communications Commission (FCC), see Appendix A
- Ferrite cores, [lii](#)
- Flash ROM, [xlvi](#)
- Flexible numbering, see System Renumbering
- Follow Me, see Forward and Follow Me
- Forced Account Code Entry, [li](#)
- Forced Account Code Entry, see Account Code Entry/Forced Account Code Entry
- Forward and Follow Me, [326](#) to [349](#)
- Forward and Follow Me, feature interactions
 - Account Code Entry/Forced Account Code Entry, [35](#), [341](#)
 - Allowed/Disallowed Lists, [47](#), [341](#)
 - Authorization Code, [54](#), [342](#)
 - Auto Answer All, [58](#), [342](#)
 - Auto Dial, [66](#), [342](#)
 - Automatic Route Selection (ARS), [92](#), [342](#)
 - Barge-In, [97](#), [342](#)
 - Call Waiting, [114](#), [343](#)
 - Callback, [121](#), [342](#)
 - Caller ID, [129](#), [343](#)
 - calling restrictions, [138](#), [341](#)
 - Camp-On, [143](#), [343](#)
 - Centrex operation, [156](#)
 - Computer Telephony Integration (CTI) link, [221](#), [344](#)
 - Conference, [166](#), [343](#)
 - Coverage, [202](#), [343](#)
 - digital data calls, [228](#), [344](#)
 - Direct Station Selector (DSS), [254](#), [344](#)
 - Direct Voice Mail, [262](#), [345](#)
 - Direct-Line Console (DLC), [237](#)
 - Display, [294](#), [345](#)
 - Do Not Disturb, [314](#), [345](#)
 - Group Calling, [346](#), [383](#)
 - HotLine, [346](#), [406](#)
 - Multi-Function Module (MFM), [346](#), [452](#)
 - Music On Hold, [346](#)

Forward and Follow Me, feature interactions, (continued)

- Night Service, [347](#), [467](#)
- Paging, [347](#), [477](#)
- Park, [347](#), [482](#)
- personal lines, [347](#), [489](#)
- Pickup, [347](#), [498](#)
- Pools, [347](#), [505](#)
- Primary Rate Interface (PRI) and T1, [347](#), [550](#)
- Queued Call Console (QCC), [585](#)
- Recall/Timed Flash, [347](#), [596](#)
- Remote Access, [347](#), [614](#)
- Ringin Options, [348](#), [624](#)
- Station Message Detail Recording (SMDR), [348](#), [668](#)
- System Access/Intercom buttons, [349](#), [681](#)
- Transfer, [349](#), [736](#)
- UDP features, [349](#), [752](#)
- Voice Announce, [349](#)

fractional T1, [520](#), [748](#)

FTS2000, [lv](#)

Full Centrex, [146](#) to [147](#)

G

General Pickup, see Pickup

General Purpose Adapter (GPA), [53](#), [56](#)

Group assignment, see Night Service

Group Call Pickup, see Pickup

Group Calling

- Calls-In-Queue Alarm Threshold, [367](#) to [368](#)

- delay announcement, [364](#) to [366](#)

- description, [350](#) to [387](#)

- Home calling group, [355](#)

- message-waiting receiver, [367](#)

- non-local member, [354](#)

- overflow receivers, [370](#) to [372](#)

- overflow threshold, [369](#)

- Priority queuing, [355](#), [360](#)

- reports about, [658](#) to [665](#)

- supervisor position, [358](#) to [360](#)

- Support calling group, [355](#)

Group calling

- prompt-based overflow, [366](#), [370](#)

- queue control, [356](#) to [358](#)

Group Calling, feature interactions

- Auto Answer All, [58](#), [380](#)

- Auto Dial, [66](#), [380](#)

- Barge-In, [97](#), [380](#)

- Call Waiting, [114](#), [381](#)

- Callback, [122](#), [380](#)

- Caller ID, [130](#), [381](#)

- Camp-On, [143](#), [381](#)

- Centrex operation, [156](#)

- Computer Telephony Integration (CTI) link, [221](#), [382](#)

- Conference, [166](#), [381](#)

- Coverage, [203](#), [381](#)

- digital data calls, [228](#), [382](#)

- Direct Station Selector (DSS), [254](#), [382](#)

Group Calling, feature interactions, (continued)

- Direct-Line Console (DLC), [237](#)
 - Display, [295](#), [383](#)
 - Do Not Disturb, [314](#), [383](#)
 - Extension Status, [321](#), [383](#)
 - Fax Extension, [324](#), [383](#)
 - Forward and Follow Me, [346](#), [383](#)
 - Hold, [383](#), [401](#)
 - HotLine, [383](#), [407](#)
 - Inspect, [383](#), [412](#)
 - Labeling, [383](#), [416](#)
 - Messaging, [384](#), [442](#)
 - Multi-Function Module (MFM), [384](#), [452](#)
 - Music On Hold, [384](#), [457](#)
 - Night Service, [384](#), [467](#)
 - Park, [384](#), [483](#)
 - personal lines, [384](#), [489](#)
 - Pickup, [384](#), [498](#)
 - Pools, [385](#), [506](#)
 - Primary Rate Interface (PRI) and T1, [385](#), [550](#)
 - Queued Call Console (QCC), [585](#)
 - Recall/Timed Flash, [385](#), [596](#)
 - Remote Access, [385](#), [615](#)
 - Ringing Options, [385](#), [624](#)
 - Signal/Notify, [385](#), [641](#), [647](#)
 - Station Message Detail Recording (SMDR), [386](#), [669](#)
 - System Access/Intercom buttons, [386](#), [681](#)
 - System Renumbering, [386](#), [697](#)
 - Transfer, [387](#), [736](#)
 - UDP features, [387](#), [753](#)
- Group Coverage, [177](#) to [178](#), [181](#) to [188](#)
- Group Coverage, see also Coverage
- Group IV (G4) fax, [100](#), [518](#), [520](#)
- Group Paging, see Paging
- Group Pickup, see Pickup
-

H

- HackerTracker, [lii](#)
- Handset Mute, see Headset options
- Hands-Free Answer on Intercom (HFAI), feature interactions
 - Microphone Disable, [445](#)
 - Primary Rate Interface (PRI) and T1, [60](#), [550](#)
 - Queued Call Console (QCC), [586](#)
 - UDP features, [753](#)
- Hands-Free Answer on Intercom (HFAI), see also Auto Answer Intercom
- Hands-Free Unit, see Auto Answer Intercom
- Headset
 - Auto Answer, [390](#) to [391](#)
 - Hang Up, [388](#) to [389](#)
 - Status, [389](#) to [390](#)
- Headset options, [388](#) to [394](#)
- Headset options, feature interactions
 - Authorization Code, [54](#), [393](#)
 - Auto Dial, [66](#), [393](#)
 - Automatic Line Selection, [74](#), [393](#)
 - Barge-In, [97](#), [393](#)

Headset options, feature interactions, (continued)

- Callback, [122](#), [393](#)
- Caller ID, [130](#), [393](#)
- Conference, [166](#), [393](#)
- Direct Voice Mail, [262](#), [393](#)
- Do Not Disturb, [314](#), [393](#)
- Hold, [393](#), [401](#)
- Paging, [393](#), [477](#)
- Park, [394](#), [483](#)
- Privacy, [394](#), [555](#)
- Queued Call Console (QCC), [586](#)
- Ringling Options, [394](#), [624](#)
- Ringling/Idle Line Preference, [394](#)
- Transfer, [394](#), [736](#)

Headset/Handset Mute, [391](#)

Helpline, Lucent Technologies, [lx](#)

Helpline, Lucent Technologies, see Appendix A

HFAI, see Hands-Free Answer on Intercom (HFAI), Auto Answer Intercom

Hold

- description, [395](#) to [403](#)
- Disconnect Interval setting, [396](#)
- DLC Operator Automatic setting, [396](#)
- one-touch, [727](#)
- Operator Timer setting, [396](#)
- QCC Release setting, [397](#)
- QCC Return setting, [397](#)

Hold Return, see Queued Call Console (QCC)

Hold, feature interactions

- Allowed/Disallowed Lists, [400](#)
- Authorization Code, [54](#), [400](#)
- Auto Dial, [66](#), [400](#)
- Basic Rate Interface (BRI), [108](#), [400](#)
- Call Waiting, [114](#), [400](#)
- Callback, [122](#), [400](#)
- Computer Telephony Integration (CTI) link, [221](#), [400](#)
- Conference, [167](#), [400](#)
- Coverage, [204](#), [400](#)
- digital data calls, [228](#), [401](#)
- Direct Station Selector (DSS), [255](#), [401](#)
- Direct-Line Console (DLC), [237](#)
- Directories, [269](#), [401](#)
- Display, [296](#), [401](#)
- Fax Extension, [324](#), [401](#)
- Group Calling, [383](#), [401](#)
- Headset options, [393](#), [401](#)
- HotLine, [401](#), [407](#)
- Inspect, [401](#), [412](#)
- Multi-Function Module (MFM), [401](#), [452](#)
- Paging, [401](#), [477](#)
- Park, [401](#), [483](#)
- personal lines, [402](#), [490](#)
- Pickup, [402](#)
- Primary Rate Interface (PRI) and T1, [550](#)
- Privacy, [402](#), [555](#)
- Queued Call Console (QCC), [586](#)
- Recall/Timed Flash, [402](#), [596](#)
- Speed Dial, [402](#), [653](#)
- System Access/Intercom buttons, [402](#), [681](#)
- Transfer, [403](#), [736](#)

Home calling group, [360](#)

Hotel mode, see Extension Status
HotLine, [404](#) to [407](#)
HotLine, feature interactions
 Account Code Entry/Forced Account Code Entry, [35](#), [406](#)
 Allowed/Disallowed Lists, [47](#), [406](#)
 Automatic Route Selection (ARS), [92](#), [406](#)
 Barge-In, [97](#), [406](#)
 Call Waiting, [114](#), [406](#)
 Callback, [122](#), [406](#)
 calling restrictions, [138](#), [406](#)
 Conference, [167](#), [406](#)
 Coverage, [204](#), [406](#)
 Extension Status, [321](#), [406](#)
 Forward and Follow Me, [346](#), [406](#)
 Group Calling, [383](#), [407](#)
 Hold, [401](#), [407](#)
 Last Number Dial, [407](#), [425](#)
 Multi-Function Module (MFM), [452](#)
 Night Service, [407](#), [467](#)
 Park, [407](#), [477](#), [483](#)
 Pickup, [407](#), [498](#)
 Pools, [407](#), [506](#)
 Privacy, [407](#), [555](#)
 Recall/Timed Flash, [407](#), [596](#), [624](#)
 Speed Dial, [407](#), [654](#)
 Transfer, [407](#), [737](#)
 UDP features, [407](#), [753](#)
Hunt groups, see Group Calling
Hunt type, see Group Calling

I

ICLID, see Caller ID
ICOM buttons, [676](#) to [677](#)
ICOM buttons, see also System Access/Intercom buttons
Idle Line Preference, see Automatic Line Selection and Ringing/Idle Line Preference
Immediate ring, see Ringing Options
In, [366](#)
Incoming Call Line Identification (ICLID), [xlviii](#)
Incoming Call Line Identification (ICLID), see Caller ID
Individual Coverage, [173](#) to [176](#), [181](#) to [188](#)
Individual Coverage, see also Coverage
Individual Pickup, see Pickup
Inside Auto Dial, [62](#)
Inside Auto Dial, see also Auto Dial
Inside Dial Tone, [408](#) to [409](#)
Inspect, [410](#) to [412](#)
Inspect, feature interactions
 Alarm, [38](#), [411](#)
 Conference, [167](#), [411](#)
 Direct Station Selector (DSS), [256](#), [412](#)
 Display, [297](#), [410](#) to [412](#)
 Drop, [412](#)
 Group Calling, [412](#)
 Hold, [401](#), [412](#)
 Last Number Dial, [412](#), [425](#)
 Paging, [412](#), [477](#)

Inspect, feature interactions, (continued)
 Queued Call Console (QCC), [586](#)
 Saved Number Dial, [412](#), [629](#)
 Transfer, [412](#), [737](#)
Integrated Solution II (IS II), [152](#), [561](#)
Integrated Solution III (IS III), [152](#), [561](#), [656](#), [696](#)
Integrated Voice Power, [372](#), [717](#)
Interexchange (IXC) calls, [705](#)
Intuity, [717](#), [I-4](#), [GL-16](#)
Intuity, see also Appendix I
ISDN Ordering Code (IOC), [101](#)
ISDN Terminal Adapter, [I-41](#)
ISDN/BRI interface, see Basic Rate Interface (BRI)
ISDN/PRI interface, see Primary Rate Interface (PRI) and T1

L

Labeling, [413](#) to [417](#)
Labeling, feature interactions
 Directories, [269](#), [416](#)
 Do Not Disturb, [314](#), [416](#)
 Group Calling, [383](#), [416](#)
 Messaging, [417](#), [442](#)
 Speed Dial, [654](#)
 UDP features, [417](#), [753](#)
Language
 selection, [lvj](#)
Language choice, [418](#) to [422](#)
Language choice, feature interactions
 Alarm Clock, [41](#), [422](#)
 Reminder service, [422](#), [601](#)
Last Number Dial, [423](#) to [426](#)
Last Number Dial, feature interactions
 Authorization Code, [54](#), [425](#)
 Auto Dial, [66](#), [425](#)
 digital data calls, [229](#), [425](#)
 Direct Station Selector (DSS), [256](#), [425](#)
 Directories, [269](#), [425](#)
 Display, [297](#), [425](#)
 HotLine, [407](#), [425](#)
 Inspect, [412](#), [425](#)
 Microphone Disable, [426](#), [445](#)
 Queued Call Console (QCC), [586](#)
 Recall/Timed Flash, [426](#), [596](#)
 Speed Dial, [426](#), [654](#)
 Station Message Detail Recording (SMDR), [426](#), [670](#)
 System Access/Intercom buttons, [426](#), [682](#)
 Transfer, [426](#), [737](#)
Last Number Redial, see Last Number Dial
Leave Message, [lvj](#)
Leave Message, see Messaging
Leave Word Calling, see Messaging
Limited Centrex, [148](#)
Line Pickup, see Pickup
Line Request, [427](#) to [428](#)

Line Request, feature interactions

- Callback, [122](#), [428](#)
- Camp-On, [143](#), [428](#)
- Park, [428](#), [483](#)
- Pools, [428](#), [506](#)
- Queued Call Console (QCC), [586](#)
- System Access/Intercom buttons, [428](#), [682](#)
- Transfer, [428](#), [737](#)

Line/trunk pool button access, see Pools

Lines/trunks

- Basic Rate Interface (BRI), [99](#) to [109](#)
- Primary Rate Interface (PRI) and T1, [509](#) to [552](#)
- Remote Access, [43](#), [607](#) to [609](#)
- routing calls, [77](#) to ??

Local and Toll tables, Default, see Automatic Route Selection (ARS)

Local Exchange Tables, [80](#)

Logical IDs, [695](#)

Loop-Start Identification (LS-ID) Delay option, [126](#)

Loop-Start Identification (LS-ID) Delay option, see also Caller ID

Loudspeaker Paging, [li](#), [473](#)

Loudspeaker Paging, see also Paging

LS-ID Delay option, see Loop-Start Identification (LS-ID) Delay option

Lucent Technologies

- Attendant, [372](#), [717](#)
- Fax Attendant, [717](#)

M

Magic-on-Hold, [liii](#)

Maintenance

- enhancements, [lvi](#)

Maintenance Alarm, see Alarm

Maintenance Busy, see Automatic Maintenance Busy

Manual signaling, see Signal/Notify

MERLIN Identifier, [liii](#)

MERLIN II System Display Console, see Direct-Line Console (DLC), Direct Station Selector (DSS)

MERLIN LEGEND Enhanced Service Center, [l-16](#)

MERLIN LEGEND MAIL, [319](#), [372](#)

MERLIN LEGEND Mail, [153](#)

- touch-tone receivers (TTRs), [721](#)

MERLIN LEGEND MAIL module, [721](#)

MERLIN LEGEND MAIL, see also Appendix I

MERLIN LEGEND Reporter, [656](#)

MERLIN LEGEND Reporter, see also Appendix I

MERLIN MAIL, [153](#), [319](#), [372](#), [717](#)

Message Center operation, see Queued Call Console (QCC)

Message-waiting receivers, [436](#)

Message-waiting receivers, see also Group Calling, Messaging

Messaging, [429](#) to [443](#)

Messaging 2000, [l-2](#)

Messaging, feature interactions

- Barge-In, [97](#), [441](#)
- digital data calls, [229](#), [441](#)
- Direct Station Selector (DSS), [256](#), [441](#)
- Direct-Line Console (DLC), [237](#)
- Directories, [269](#), [441](#)
- Display, [298](#), [441](#)

Messaging, feature interactions, (continued)

- Do Not Disturb, [314](#), [442](#)
- Fax Extension, [324](#), [442](#)
- Group Calling, [384](#), [442](#)
- Labeling, [417](#), [442](#)
- Multi-Function Module (MFM), [442](#), [452](#)
- Queued Call Console (QCC), [586](#)
- Signal/Notify, [443](#), [647](#)
- System Access/Intercom buttons, [443](#), [682](#)
- Transfer, [443](#), [737](#)
- UDP features, [443](#), [753](#)

MFM, see Multi-Function Module (MFM)

Microphone Disable, [444](#) to [445](#)

Microphone Disable, feature interactions

- Auto Dial, [66](#), [445](#)
- Hands-Free Answer on Intercom (HFAI), [445](#)
- Last Number Dial, [426](#), [445](#)
- Paging, [445](#), [477](#)
- Queued Call Console (QCC), [586](#)
- Saved Number Dial, [445](#), [629](#)
- Transfer, [445](#), [737](#)
- Voice Announce to Busy, [445](#), [760](#)

Missed Reminder, see Reminder service

MLS telephone display, [272](#)

MLS telephones

- Account Code Entry, [33](#)
- Display information, [282](#)

MLX Telephones

- Account Code Entry, [32](#)

MLX-10DP telephone, [lii](#)

MLX-20L telephone, [559](#) to [561](#)

Modem

- processor, [xlvi](#)

Modes of operation, see Appendix C

Modules

- supplying touch-tone receivers (TTRs), [721](#)

Multi-Function Module (MFM), [446](#) to [453](#)

Multi-Function Module (MFM), feature interactions

- Automatic Line Selection, [74](#), [451](#)
- Callback, [122](#), [451](#)
- Conference, [167](#), [452](#)
- Coverage, [204](#), [452](#)
- digital data calls, [229](#), [452](#)
- Direct-Line Console (DLC), [237](#)
- Do Not Disturb, [315](#), [452](#)
- Fax Extension, [324](#), [452](#)
- Forward and Follow Me, [346](#), [452](#)
- Group Calling, [384](#), [452](#)
- Hold, [401](#), [452](#)
- HotLine, [452](#)
- Messaging, [442](#), [452](#)
- Night Service, [452](#), [467](#)
- Paging, [452](#), [477](#)
- Park, [452](#), [483](#)
- personal lines, [452](#), [490](#)
- Privacy, [452](#), [555](#)
- Queued Call Console (QCC), [586](#)
- Recall/Timed Flash, [453](#), [596](#)
- Ringing Options, [453](#), [624](#)
- Signal/Notify, [453](#), [642](#), [647](#)

Multi-Function Module (MFM), feature interactions, (continued)

Station Message Detail Recording (SMDR), [453](#), [670](#)

System Access/Intercom buttons, [453](#), [682](#)

Transfer, [453](#), [737](#)

Voice Announce to Busy, [453](#), [760](#)

Multiline Hunt Group, [101](#) to [102](#)

Music On Hold, [454](#) to [457](#)

Music On Hold, feature interactions

Callback, [122](#), [457](#)

Camp-On, [143](#), [457](#)

Conference, [167](#), [457](#)

Forward and Follow Me, [346](#)

Group Calling, [384](#), [457](#)

Night Service, [457](#), [467](#)

Park, [457](#), [483](#)

personal lines, [457](#), [490](#)

Pools, [457](#), [506](#)

Primary Rate Interface (PRI) and T1, [550](#)

Remote Access, [457](#), [615](#)

Transfer, [457](#), [737](#)

UDP features, [457](#), [754](#)

Mute, Headset/Handset, see Headset options

Mute, see Microphone Disable

N

N11 table, see Automatic Route Selection (ARS)

Next Message, see Messaging

Night Service, [liv](#), [135](#) to [136](#), [458](#) to [468](#)

Night Service, feature interactions

Alarm, [39](#), [466](#)

Allowed/Disallowed Lists, [47](#)

Authorization Code, [54](#), [466](#)

Automatic Route Selection (ARS), [92](#), [466](#)

Caller ID, [130](#), [466](#)

calling restrictions, [138](#), [466](#)

Coverage, [204](#), [462](#) to [463](#), [466](#)

digital data calls, [229](#), [466](#)

Direct-Line Console (DLC), [238](#)

Display, [299](#), [467](#)

Forward and Follow Me, [347](#), [467](#)

Group Calling, [384](#), [467](#)

HotLine, [407](#), [467](#)

Multi-Function Module (MFM), [452](#), [467](#)

Music On Hold, [457](#), [467](#)

Paging, [467](#), [477](#)

personal lines, [467](#), [490](#)

Pickup, [468](#), [498](#)

Primary Rate Interface (PRI) and T1, [468](#), [551](#)

Queued Call Console (QCC), [586](#)

Recall/Timed Flash, [596](#)

Remote Access, [468](#), [615](#)

Ringling Options, [468](#), [624](#)

System Access/Intercom buttons, [468](#), [682](#)

tandem switching, [710](#)

UDP features, [468](#), [754](#)

No Ring option, see Ringling Options

Non-local dial plan
 call handling, [746](#) to [747](#)
 extension ranges, [743](#) to [746](#)
 Transfer, [748](#)
 UDP routing, [747](#)
Non-local Uniform Dial Plan (UDP)
 Facility Restriction Levels (FRLs), [706](#)
Notify, see Signal/Notify
Novell NetWare, [208](#), [210](#)
Numbering plan, see System Renumbering

O

Off-Premises Range Extender (OPRE), [liii](#)
On- or off-hook queuing, see Callback
One-Touch Hold, see Transfer
One-Touch Transfer, see Transfer
Operator Automatic Hold, see Hold
Operator Hold Timer, see Hold
Other digits, [705](#)
Outside Auto Dial, [62](#), [63](#)
Outside Auto Dial, see also Auto Dial
Outward restriction, see Calling restrictions, Night Service

P

PagePac Plus, [liii](#)
Paging, [470](#) to [478](#)
Paging groups, [471](#) to [472](#)
Paging, feature interactions
 Account Code Entry/Forced Account Code Entry, [476](#)
 Auto Dial, [66](#), [476](#)
 Barge-In, [97](#), [476](#)
 Call Waiting, [114](#), [476](#)
 Callback, [122](#), [476](#)
 Camp-On, [143](#), [476](#)
 Conference, [167](#), [476](#)
 digital data calls, [229](#), [476](#)
 Direct Station Selector (DSS), [256](#), [476](#)
 Direct-Line Console (DLC), [238](#)
 Display, [300](#), [476](#)
 Do Not Disturb, [315](#), [477](#)
 Forward and Follow Me, [347](#), [477](#)
 Headset options, [393](#), [477](#)
 Hold, [401](#), [477](#)
 Inspect, [412](#), [477](#)
 Microphone Disable, [445](#), [477](#)
 Multi-Function Module (MFM), [452](#), [477](#)
 Night Service, [467](#), [477](#)
 personal lines, [477](#), [490](#)
 Pickup, [477](#), [498](#)
 Pools, [477](#), [506](#)
 Primary Rate Interface (PRI) and T1, [477](#), [551](#)
 Queued Call Console (QCC), [587](#)
 Remote Access, [477](#), [615](#)

Paging, feature interactions, (continued)

- Station Message Detail Recording (SMDR), [477](#), [670](#)
- System Access/Intercom buttons, [477](#), [682](#)
- System Renumbering, [477](#)
- Transfer, [478](#), [738](#)
- UDP features, [478](#), [754](#)
- Voice Announce to Busy, [478](#), [760](#)

Park, [479](#) to [483](#)

Park, feature interactions

- Authorization Code, [55](#), [482](#)
- Auto Dial, [66](#), [482](#)
- Callback, [122](#), [482](#)
- Conference, [167](#), [482](#)
- Coverage, [204](#), [482](#)
- digital data calls, [229](#), [482](#)
- Direct Station Selector (DSS), [257](#), [482](#)
- Direct-Line Console (DLC), [238](#)
- Display, [300](#), [482](#)
- Forward and Follow Me, [347](#), [482](#)
- Group Calling, [384](#), [483](#)
- Headset options, [394](#), [483](#)
- Hold, [401](#), [483](#)
- HotLine, [407](#), [477](#), [483](#)
- Line Request, [428](#), [483](#)
- Multi-Function Module (MFM), [452](#), [483](#)
- Music On Hold, [457](#), [483](#)
- Pickup, [483](#), [498](#)
- Queued Call Console (QCC), [587](#)
- Recall/Timed Flash, [483](#), [596](#)
- Station Message Detail Recording (SMDR), [483](#), [670](#)
- System Access/Intercom buttons, [483](#), [682](#)
- System Renumbering, [483](#)
- Transfer, [483](#), [738](#)
- UDP features, [754](#)

PassageWay Direct Connection Solution, see Appendix I

PassageWay Solution, [liii](#)

PassageWay Telephony Services, see CTI link

PCMCIA Memory Card, [xlvii](#)

Personal Directory, [li](#), [265](#) to [266](#)

Personal Directory, see also Directories

Personal lines, [484](#) to [492](#)

Personal Lines, feature interactions

- Display, [300](#)

Personal lines, feature interactions

- Account Code Entry/Forced Account Code Entry, [35](#), [487](#)
- Alarm, [39](#), [487](#)
- Allowed/Disallowed Lists, [47](#), [488](#)
- Auto Dial, [66](#), [488](#)
- Call Waiting, [114](#), [488](#)
- Callback, [122](#), [488](#)
- Caller ID, [130](#), [488](#)
- calling restrictions, [139](#), [488](#)
- Computer Telephony Integration (CTI) link, [221](#), [489](#)
- Coverage, [205](#), [488](#)
- digital data calls, [229](#), [489](#)
- Direct-Line Console (DLC), [238](#)
- Directories, [269](#), [489](#)
- Forward and Follow Me, [347](#), [489](#)
- Group Calling, [384](#), [489](#)
- Hold, [402](#), [490](#)

Personal lines, feature interactions, (continued)

- Multi-Function Module (MFM), [452](#), [490](#)
- Music On Hold, [457](#), [490](#)
- Night Service, [467](#), [490](#)
- Paging, [477](#), [490](#)
- Pickup, [491](#), [499](#)
- Pools, [491](#), [506](#)
- Primary Rate Interface (PRI) and T1, [491](#), [551](#)
- Privacy, [491](#), [555](#)
- Queued Call Console (QCC), [587](#)
- Recall/Timed Flash, [491](#), [596](#)
- System Access/Intercom buttons, [491](#), [682](#)
- tandem switching, [491](#), [710](#)
- Transfer, [492](#), [738](#)
- UDP features, [754](#)

Personal Speed Dial, [649](#) to [650](#)

Personal Speed Dial, see also Speed Dial

Personalized Ring, see Ringing Options

Pickup, [493](#) to [499](#)

Pickup, feature interactions

- Call Waiting, [114](#), [497](#)
- Callback, [122](#), [497](#)
- Conference, [168](#), [497](#)
- Coverage, [205](#), [498](#)
- digital data calls, [229](#), [498](#)
- Direct Station Selector (DSS), [257](#), [498](#)
- Direct-Line Console (DLC), [238](#)
- Display, [301](#), [498](#)
- Forward and Follow Me, [347](#), [498](#)
- Group Calling, [384](#), [498](#)
- Hold, [402](#)
- HotLine, [407](#), [498](#)
- Night Service, [468](#), [498](#)
- Paging, [477](#), [498](#)
- Park, [483](#), [498](#)
- personal lines, [491](#), [499](#)
- Queued Call Console (QCC), [587](#)
- Station Message Detail Recording (SMDR), [499](#), [670](#)
- System Access/Intercom buttons, [499](#), [683](#)
- Transfer, [499](#), [738](#)
- UDP features, [499](#), [754](#)

Planning forms, see Appendix B

Pool dial-out code restriction, [134](#)

Pool dial-out code restriction, see also Calling restrictions

Pool routing, see Automatic Route Selection (ARS)

Pool, feature interactions

- Direct Station Selector (DSS), [257](#)

Pools, [500](#) to [710](#)

Pools, feature interactions

- Account Code Entry/Forced Account Code Entry, [35](#), [504](#)
- Alarm, [39](#), [504](#)
- Auto Dial, [67](#), [505](#)
- Automatic Maintenance Busy, [76](#), [505](#)
- Automatic Route Selection (ARS), [92](#), [505](#)
- Callback, [123](#), [505](#)
- Caller ID, [130](#), [505](#)
- calling restrictions, [139](#), [505](#)
- Computer Telephony Integration (CTI) link, [221](#), [505](#)
- Coverage, [205](#), [505](#)
- digital data calls, [229](#), [505](#)

Pools, feature interactions, (continued)

- Direct-Line Console (DLC), [238](#)
- Directories, [269](#), [505](#)
- Display, [302](#), [505](#)
- Forward and Follow Me, [347](#), [505](#)
- Group Calling, [385](#), [506](#)
- HotLine, [407](#), [506](#)
- Line Request, [428](#), [506](#)
- Music On Hold, [457](#), [506](#)
- Paging, [477](#), [506](#)
- personal lines, [491](#), [506](#)
- Primary Rate Interface (PRI) and T1, [506](#), [551](#)
- Queued Call Console (QCC), [588](#)
- Recall/Timed Flash, [506](#), [596](#)
- Speed Dial, [506](#), [654](#)
- Station Message Detail Recording (SMDR), [506](#), [670](#)
- System Renumbering, [506](#)
- tandem switching, [710](#)
- UDP features, [506](#), [754](#)

Position Busy Backup, see Queued Call Console (QCC)

Posted Messages, [437](#)

Posted Messages, see also Messaging

Power Failure Transfer, [507](#) to [508](#)

Power Failure Transfer, feature interactions, [508](#), [670](#)

Power supply

- ferrite cores, [lii](#)

PRI, see Primary Rate Interface (PRI) and T1

Primary Coverage, see Coverage

Primary Rate Interface (PRI), [lv](#)

- DEFINITY and, [lii](#)

Primary Rate Interface (PRI) and T1

- benefits, [517](#) to [518](#), [520](#) to [521](#)

- call processing, [532](#) to [542](#)

- capacity, [516](#)

- description, [509](#) to [552](#)

- emulation of analog lines/trunks, [520](#)

- features, [518](#) to [519](#), [521](#)

- lines, [515](#) to [516](#)

- network services supported, [522](#) to [523](#)

- programming options, [521](#) to [532](#), [542](#) to [547](#)

- switches supported, [514](#)

- tandem switching, [527](#) to [529](#)

Primary Rate Interface (PRI) and T1, feature interactions

- Account Code Entry/Forced Account Code Entry, [35](#), [549](#)

- Automatic Route Selection (ARS), [92](#), [549](#)

- Barge-In, [550](#)

- Call Waiting, [114](#), [550](#)

- Callback, [123](#), [550](#)

- calling restrictions, [139](#), [550](#)

- Camp-On, [550](#)

- Conference, [550](#)

- Coverage, [550](#)

- Display, [290](#), [304](#)

- Forward and Follow Me, [347](#), [550](#)

- Group Calling, [385](#), [550](#)

- Hands-Free Answer on Intercom (HFAI), [60](#), [550](#)

- Hold, [550](#)

- Music On Hold, [550](#)

- Night Service, [468](#), [551](#)

- Paging, [477](#), [551](#)

Primary Rate Interface (PRI) and T1, feature interactions, (continued)

- personal lines, [491](#), [551](#)
- Pools, [506](#), [551](#)
- Remote Access, [551](#), [615](#)
- Ringing Options, [551](#)
- Station Message Detail Recording (SMDR), [551](#), [670](#)
- System Access/Intercom buttons, [551](#), [683](#)
- tandem switching, [552](#), [711](#)
- Transfer, [552](#), [738](#)

Prime lines, see Centrex operation

Printer, see Station Message Detail Recording (SMDR)

Priority Queuing Considerations, [377](#)

Privacy, [553](#) to [556](#)

Privacy, feature interactions

- Barge-In, [98](#), [555](#)
- digital data calls, [230](#), [555](#)
- Display, [302](#), [555](#)
- Headset options, [394](#), [555](#)
- Hold, [402](#), [555](#)
- HotLine, [407](#), [555](#)
- Multi-Function Module (MFM), [452](#), [555](#)
- personal lines, [491](#), [555](#)
- Queued Call Console (QCC), [588](#)
- Recall/Timed Flash, [555](#), [596](#)
- Signal/Notify, [556](#), [643](#), [647](#)
- System Access/Intercom buttons, [556](#), [683](#)

Programming

- buttons, see Appendix D, Appendix G
- centralized telephone, [564](#)
- console, [559](#) to [561](#)
- description, [557](#) to [564](#)
- enhancements, [lvii](#)
- extension, [564](#)
- security risk, [557](#) to [558](#)
- special characters, see Appendix H
- system, [559](#) to [563](#)
- System Programming and Maintenance (SPM) software, [561](#) to [563](#)
- system, see also Appendix E
- telephones, see Appendix D, Appendix G, Appendix H

Programming, see also Integrated Administration and Appendix D

Prompted digits, see Collected digits

Q

Queued Call Console (QCC)

- assigning lines, [573](#) to [574](#)
- backup position, [578](#)
- buttons, [571](#) to [573](#)
- description, [565](#) to [589](#)
- features, [570](#) to [573](#)
- messaging, [577](#) to [578](#)
- operation, [568](#) to [570](#)
- operator availability, [568](#) to [569](#)
- options, programmed, [573](#) to [580](#)
- types of calls, [574](#) to [576](#)

Queued Call Console (QCC), feature interactions

- Account Code Entry/Forced Account Code Entry, [582](#)
- Alarm, [582](#)
- Allowed/Disallowed Lists, [582](#)
- Authorization Codes, [582](#)
- Auto Answer All, [582](#)
- Auto Answer Intercom, [582](#)
- Auto Dial, [582](#)
- Automatic Line Selection, [582](#)
- Barge-In, [582](#)
- Callback, [582](#)
- calling restrictions, [582](#)
- Camp-On, [583](#)
- Computer Telephony Integration (CTI) link, [584](#)
- Conference, [583](#)
- Coverage, [583](#)
- Direct Voice Mail, [584](#)
- Directories, [584](#)
- Display, [585](#)
- Do Not Disturb, [585](#)
- Extension Status, [585](#)
- Forward and Follow Me, [585](#)
- Group Calling, [585](#)
- Hands-Free Answer on Intercom (HFAI), [586](#)
- Headset options, [586](#)
- Hold, [586](#)
- Inspect, [586](#)
- Last Number Dial, [586](#)
- Line Request, [586](#)
- Messaging, [586](#)
- Microphone Disable, [586](#)
- Multi-Function Module (MFM), [586](#)
- Night Service, [586](#)
- Paging, [587](#)
- Park, [587](#)
- personal lines, [587](#)
- Pickup, [587](#)
- Pools, [588](#)
- Privacy, [588](#)
- Recall/Timed Flash, [588](#)
- Reminder service, [588](#)
- Remote Access, [588](#)
- Ringing Options, [588](#)
- Saved Number Dial, [588](#)
- Signal/Notify, [589](#)
- Speed Dial, [589](#)
- Station Message Detail Recording (SMDR), [589](#)
- System Access/Intercom buttons, [589](#)
- System Renumbering, [589](#)
- Transfer, [589](#)
- Voice Announce to Busy, [589](#)

Queued Call Console, feature interactions

- Direct Station Selector (DSS), [257](#)

Queued Call Consoles

- Account Code Entry, [32](#)

R

- Recall/Timed Flash, [590](#) to [597](#)
- Recall/Timed Flash, feature interactions
 - Allowed/Disallowed Lists, [47](#), [594](#)
 - Auto Dial, [67](#), [594](#)
 - Automatic Route Selection (ARS), [92](#), [595](#)
 - Barge-In, [98](#), [595](#)
 - Basic Rate Interface (BRI), [108](#), [595](#)
 - Call Waiting, [115](#), [595](#)
 - Callback, [123](#), [595](#)
 - calling restrictions, [47](#), [139](#), [594](#)
 - Centrex operation, [156](#)
 - Conference, [168](#), [595](#)
 - Coverage, [205](#), [595](#)
 - Directories, [269](#), [595](#)
 - Display, [302](#), [596](#)
 - Forward and Follow Me, [347](#), [596](#)
 - Group Calling, [385](#), [596](#)
 - Hold, [402](#), [596](#)
 - HotLine, [407](#), [596](#), [624](#)
 - Last Number Dial, [426](#), [596](#)
 - Multi-Function Module (MFM), [453](#), [596](#)
 - Night Service, [596](#)
 - Park, [483](#), [596](#)
 - personal lines, [491](#), [596](#)
 - Pools, [506](#), [596](#)
 - Privacy, [555](#), [596](#)
 - Queued Call Console (QCC), [588](#)
 - Reminder service, [596](#), [601](#)
 - Saved Number Dial, [596](#), [629](#)
 - Speed Dial, [596](#), [654](#)
 - Station Message Detail Recording (SMDR), [596](#), [671](#)
 - System Access/Intercom buttons, [597](#), [683](#)
 - Transfer, [597](#), [738](#)
- Release 4.1 and later systems, [171](#) to [188](#), [327](#), [458](#) to [463](#), [619](#) to [620](#)
- Release 4.2 and later systems, [518](#), [523](#) to [524](#), [530](#), [665](#)
- Release 5.0 and later systems, [351](#) to [382](#), [404](#) to [407](#), [456](#), [652](#)
- Release 6.0 and later systems, [146](#), [308](#), [326](#), [329](#) to [331](#), [351](#), [356](#) to [358](#), [369](#) to [370](#), [711](#), [D-7](#), [D-16](#), [D-23](#)
- Reminder service, [598](#) to [601](#)
- Reminder service, feature interactions
 - Call Waiting, [115](#), [601](#)
 - Callback, [123](#), [601](#)
 - Coverage, [205](#), [601](#)
 - digital data calls, [230](#), [601](#)
 - Direct-Line Console (DLC), [238](#)
 - Display, [303](#)
 - Do Not Disturb, [315](#), [601](#)
 - language choice, [422](#), [601](#)
 - Queued Call Console (QCC), [588](#)
 - Recall/Timed Flash, [596](#), [601](#)
 - Ringing Options, [601](#), [625](#)
 - System Access/Intercom buttons, [601](#), [683](#)
 - UDP features, [601](#), [755](#)

- Remote Access, [xlviii](#)
 - barrier codes, [610](#) to [612](#)
 - calling restrictions, [135](#)
 - description, [602](#) to [616](#)
 - lines/trunks, [607](#) to [609](#)
 - renumbering, [695](#)
 - security risks, [603](#) to [605](#)
 - touch-tone or rotary signaling, [717](#)
 - using, [609](#) to [610](#)
- Remote Access, feature interactions
 - Account Code Entry/Forced Account Code Entry, [35](#), [613](#)
 - Allowed/Disallowed Lists, [47](#), [613](#)
 - Authorization Code, [55](#), [614](#)
 - Automatic Route Selection (ARS), [93](#), [614](#)
 - Basic Rate Interface (BRI), [109](#)
 - Callback, [123](#), [614](#)
 - Caller ID, [130](#), [614](#)
 - Conference, [168](#), [614](#)
 - digital data calls, [230](#), [614](#)
 - Direct-Line Console (DLC), [238](#)
 - Display, [304](#), [614](#)
 - Forward and Follow Me, [347](#), [614](#)
 - Group Calling, [385](#), [615](#)
 - Music On Hold, [457](#), [615](#)
 - Night Service, [468](#), [615](#)
 - Paging, [477](#), [615](#)
 - Primary Rate Interface (PRI) and T1, [551](#), [615](#)
 - Queued Call Console (QCC), [588](#)
 - Station Message Detail Recording (SMDR), [616](#), [671](#)
 - System Renumbering, [616](#)
 - tandem switching, [616](#), [711](#)
- Remote Call Forwarding, see Forward and Follow Me
- Reports
 - calling groups, [658](#) to [665](#)
 - language, [420](#)
 - sample, see Appendix F
- Reports, see also Station Message Detail Recording (SMDR)
- Restrictions, see Calling restrictions
- Retrieve Message, see Messaging
- Return Call, see Messaging
- Return Ring Interval, see Queued Call Console (QCC)
- Ring timing options, [619](#) to [620](#)
- Ring timing options, see also Ringing Options
- Ringback (Transfer Audible), see Transfer
- Ringing Options, [618](#) to [625](#)
- Ringing Options, feature interactions
 - Auto Answer All, [58](#), [623](#)
 - Automatic Line Selection, [74](#), [623](#)
 - Caller ID, [130](#), [623](#)
 - Coverage, [206](#), [623](#)
 - digital data calls, [230](#), [623](#)
 - Fax Extension, [324](#), [624](#)
 - Forward and Follow Me, [348](#), [624](#)
 - Group Calling, [385](#), [624](#)
 - Headset options, [394](#), [624](#)
 - Multi-Function Module (MFM), [453](#), [624](#)
 - Night Service, [468](#), [624](#)
 - Primary Rate Interface (PRI) and T1, [551](#)
 - Queued Call Console (QCC), [588](#)

Ringling Options, feature interactions, (continued)

Reminder service, [601](#), [625](#)

System Access/Intercom buttons, [683](#)

Transfer, [625](#), [738](#)

Ringling/Idle Line Preference, feature interactions

Headset options, [394](#)

System Renumbering, [697](#)

Ringling/Idle Line Preference, see also Automatic Line Selection and Ringling/Idle Line Preference

Rotary Dial Enable, [717](#)

rotary signaling, [717](#)

Rotary signaling, see Touch-tone or rotary signaling

Routing by dial plan, [534](#) to [536](#), [544](#)

Routing outside calls

from system with limited PSTN facilities, [704](#)

restrictions, [707](#)

S

S56, see Primary Rate Interface (PRI) and T1

SA buttons, [674](#) to [676](#)

SA buttons, see also System Access/Intercom buttons

Satellite system, [702](#)

Saved Number Dial, [626](#) to [629](#)

Saved Number Dial, feature interactions

Authorization Code, [55](#), [628](#)

Auto Dial, [67](#), [628](#)

Automatic Route Selection (ARS), [93](#), [628](#)

Direct Station Selector (DSS), [258](#), [628](#)

Directories, [269](#), [628](#)

Display, [305](#), [629](#)

Inspect, [412](#), [629](#)

Microphone Disable, [445](#), [629](#)

Queued Call Console (QCC), [588](#)

Recall/Timed Flash, [596](#), [629](#)

Speed Dial, [629](#), [654](#)

Station Message Detail Recording (SMDR), [629](#), [671](#)

System Access/Intercom buttons, [629](#), [683](#)

Transfer, [629](#), [738](#)

Screens, see Display

Scroll, see Messaging

Second dial tone, [44](#)

Second Dial Tone Timer, [630](#) to [631](#)

Second Dial Tone Timer, feature interactions

Directories, [269](#), [631](#)

Speed Dial, [631](#), [654](#)

Secondary Coverage, see Coverage

Security

calling restrictions, [376](#)

Conference, [160](#)

Default Disallowed List, [45](#)

digital facilities, [518](#), [520](#) to [521](#)

Directories, [267](#)

Remote Access risks, [603](#) to [605](#)

remote programming, [557](#) to [558](#)

Second Dial Tone Timer, [630](#) to [631](#)

voice messaging interface (VMI) ports, [45](#), [83](#), [134](#)

Security, see also Appendix A

- Selective Callback, [117](#)
- Selective Callback, see also Callback
- Selective Coverage, [178](#) to [179](#)
- Send All Calls, see Do Not Disturb
- Send Ring, see Ringing Options
- Send/Remove Message, see Messaging
- Service Observing, [632](#) to [644](#), [D-12](#)
 - Ending a session, [635](#)
- Service Observing, feature interactions
 - Direct Station Selector (DSS), [258](#)
- Service Profile (SP), [103](#)
- Service Profile Identifier (SPID), [103](#)
- Set Up Space numbering plan, [691](#) to [692](#)
- Set Up Space numbering plan, see also System Renumbering
- Shared SA buttons, [675](#) to [676](#)
- Shared SA buttons, see also System Access/Intercom buttons
- Shared System Access (SSA), [xlviii](#)
- Shared System Access, see System Access/Intercom buttons
- Signal/Notify, [645](#) to [647](#)
- Signal/Notify, feature interactions
 - Auto Dial, [67](#), [639](#), [647](#)
 - Conference, [169](#), [639](#), [647](#)
 - digital data calls, [230](#), [647](#)
 - Direct Station Selector (DSS), [258](#), [647](#)
 - Do Not Disturb, [315](#), [641](#), [647](#)
 - Group Calling, [385](#), [641](#), [647](#)
 - Messaging, [443](#), [647](#)
 - Multi-Function Module (MFM), [453](#), [642](#), [647](#)
 - Privacy, [556](#), [643](#), [647](#)
 - Queued Call Console (QCC), [589](#)
 - Transfer, [644](#), [647](#), [739](#)
 - UDP features, [644](#), [647](#), [755](#)
- Signaling, see Signal/Notify, Touch-tone or rotary signaling
- Single-Line Telephones
 - Account Code Entry, [33](#)
- SMDR, see Station Message Detail Recording (SMDR)
- Speakerphone paging, [471](#)
- Speakerphone paging, see also Paging
- Special characters, see Appendix H
- Special Number Table, [81](#)
- Special Numbers Pattern, see Automatic Route Selection (ARS)
- Special Services Selection Table, see Primary Rate Interface (PRI) and T1
- Speed Dial
 - description, [648](#) to [654](#)
 - Personal, [649](#) to [650](#)
 - System, [648](#) to [649](#)
- Speed Dial, feature interactions
 - Account Code Entry/Forced Account Code Entry, [35](#), [653](#)
 - Allowed/Disallowed Lists, [48](#), [653](#)
 - Authorization Code, [55](#), [653](#)
 - Automatic Route Selection (ARS), [93](#), [653](#)
 - Callback, [123](#), [653](#)
 - calling restrictions, [139](#), [653](#)
 - Centrex operation, [157](#)
 - Conference, [169](#), [653](#)
 - digital data calls, [230](#), [653](#)
 - Direct-Line Console (DLC), [239](#)
 - Directories, [270](#), [653](#)
 - Drop, [653](#)
 - Hold, [402](#), [653](#)

Speed Dial, feature interactions, (continued)

- HotLine, [407](#), [654](#)
- Labeling, [654](#)
- Last Number Dial, [426](#), [654](#)
- Pools, [506](#), [654](#)
- Queued Call Console (QCC), [589](#)
- Recall/Timed Flash, [596](#), [654](#)
- Saved Number Dial, [629](#), [654](#)
- Second Dial Tone Timer, [631](#), [654](#)
- Station Message Detail Recording (SMDR), [654](#), [671](#)
- Transfer, [654](#), [739](#)
- UDP features, [654](#), [755](#)

SPM, see Programming, System Programming and Maintenance (SPM) software

Star codes, [44](#) to [45](#), [82](#), [267](#)

Station Conference, see Conference

Station lines, see System Access/Intercom buttons

Station Message Detail Recording (SMDR), [655](#) to [672](#)

Station Message Detail Recording (SMDR), feature interactions

- Account Code Entry/Forced Account Code Entry, [35](#), [667](#)
- Authorization Code, [55](#), [667](#)
- Auto Dial, [67](#), [667](#)
- Automatic Route Selection (ARS), [93](#), [667](#)
- Basic Rate Interface (BRI), [109](#), [668](#)
- Call Waiting, [115](#), [668](#)
- Callback, [123](#), [668](#)
- Caller ID, [130](#), [668](#)
- Camp-On, [143](#), [668](#)
- Centrex operation, [157](#)
- Conference, [169](#), [668](#)
- Coverage, [206](#), [668](#)
- Forward and Follow Me, [348](#), [668](#)
- Group Calling, [386](#), [669](#)
- Last Number Dial, [426](#), [670](#)
- Multi-Function Module (MFM), [453](#), [670](#)
- Paging, [477](#), [670](#)
- Park, [483](#), [670](#)
- Pickup, [499](#), [670](#)
- Pools, [506](#), [670](#)
- Power Failure Transfer, [508](#), [670](#)
- Primary Rate Interface (PRI) and T1, [551](#), [670](#)
- Queued Call Console (QCC), [589](#)
- Recall/Timed Flash, [596](#), [671](#)
- Remote Access, [616](#), [671](#)
- Saved Number Dial, [629](#), [671](#)
- Speed Dial, [654](#), [671](#)
- System Access/Intercom buttons, [671](#), [684](#)
- Transfer, [671](#), [739](#)
- UDP features, [672](#), [755](#)

Station programming, see Programming

Supplemental Alert Adapter (SAA), [447](#) to [448](#)

Supplemental Alert Adapter (SAA), see also Multi-Function Module (MFM)

Support calling group, [360](#)

Support, see Appendix A

Switched 56, see Primary Rate Interface (PRI) and T1

Switched Loop Console, see Queued Call Console (QCC)

Switchhook, [iv](#)

Switchhook (Flash), see Recall/Timed Flash

- System Access/Intercom buttons
 - description, [673](#) to [684](#)
 - ICOM buttons, [676](#) to [677](#)
 - SA buttons, [674](#) to [676](#)
 - Shared SA buttons, [675](#) to [676](#)
- System Access/Intercom buttons, feature interactions
 - Auto Answer All, [58](#), [679](#)
 - Auto Answer Intercom, [60](#), [679](#)
 - Auto Dial, [68](#)
 - Automatic Line Selection, [74](#), [679](#)
 - Automatic Route Selection (ARS), [93](#), [680](#)
 - Call Waiting, [115](#), [680](#)
 - Callback, [123](#), [680](#)
 - Caller ID, [131](#), [680](#)
 - calling restrictions, [139](#), [680](#)
 - Camp-On, [143](#)
 - Computer Telephony Integration (CTI) link, [222](#), [681](#)
 - Conference, [169](#), [680](#)
 - Coverage, [207](#), [680](#)
 - digital data calls, [230](#), [681](#)
 - Direct-Line Console (DLC), [239](#)
 - Display, [305](#), [681](#)
 - Do Not Disturb, [315](#), [681](#)
 - Forward and Follow Me, [349](#), [681](#)
 - Group Calling, [386](#), [681](#)
 - Hold, [402](#), [681](#)
 - Last Number Dial, [426](#), [682](#)
 - Line Request, [428](#), [682](#)
 - Messaging, [443](#), [682](#)
 - Multi-Function Module (MFM), [453](#), [682](#)
 - Night Service, [468](#), [682](#)
 - Paging, [477](#), [682](#)
 - Park, [483](#), [682](#)
 - personal lines, [491](#), [682](#)
 - Pickup, [499](#), [683](#)
 - Primary Rate Interface (PRI) and T1, [551](#), [683](#)
 - Privacy, [556](#), [683](#)
 - Queued Call Console (QCC), [589](#)
 - Recall/Timed Flash, [597](#), [683](#)
 - Reminder service, [601](#), [683](#)
 - Ringing Options, [683](#)
 - Saved Number Dial, [629](#), [683](#)
 - Station Message Detail Recording (SMDR), [671](#), [684](#)
 - Transfer, [684](#), [739](#)
- System Directory, [264](#) to [265](#)
- System Directory, see also Directories
- System features, list, see Appendix C
- System language, [419](#)
- System Numbering, see System Renumbering
- System planning forms, see Appendix B
- System Programming and Maintenance (SPM) software, [lvii](#), [420](#) to [421](#), [561](#) to [563](#)
 - international release, [lii](#)
- System programming hierarchy, see Appendix E
- System programming, see Programming, Appendix E
- System Renumbering, [685](#) to [697](#), [743](#)
- System Renumbering, feature interactions
 - Authorization Code, [55](#), [696](#)
 - Automatic Route Selection (ARS), [93](#), [696](#)
 - Computer Telephony Integration (CTI) link, [222](#), [696](#)
 - Direct Station Selector (DSS), [258](#), [696](#)

System Renumbering, feature interactions, (continued)

- Group Calling, [386](#), [697](#)
- Paging, [477](#)
- Park, [483](#)
- Pools, [506](#)
- Queued Call Console (QCC), [589](#)
- Remote Access, [616](#)
- Ringing/Idle Line Preference, [697](#)
- UDP features, [697](#), [755](#)

System reports, see Appendix F

System Speed Dial, [648](#) to [649](#)

System Speed Dial, see also Speed Dial

T

T1 interface (DS1), see Primary Rate Interface (PRI) and T1

Tandem switching, [699](#) to [711](#)

Primary Rate Interface (PRI) and T1, [527](#) to [529](#)

Tandem switching, feature interactions

- Allowed/Disallowed Lists, [48](#), [709](#)
- Automatic Route Selection (ARS), [93](#), [709](#)
- Callback, [709](#)
- Computer Telephony Integration (CTI) link, [710](#)
- digital data calls, [230](#), [710](#)
- Night Service, [710](#)
- personal lines, [491](#), [710](#)
- Pools, [710](#)
- Primary Rate Interface (PRI) and T1, [552](#), [711](#)
- Remote Access, [616](#), [711](#)
- Voice messaging interface (VMI) ports, [711](#)

TAPI, [GL-27](#)

Technical support, see Appendix A

Telephone programming, see Appendix D, Appendix G, Appendix H

Telephones

- buttons, see Appendix G
- contrast on display, [276](#)
- display, [271](#) to ??, [310](#) to ??
- programming, see Appendix D, Appendix G, Appendix H
- single-line, [liii](#)

Terminal Equipment Identifier (TEI) option, [532](#)

Timed flash, see Recall/Timed Flash

Timer, [712](#) to [713](#)

Timer, feature interactions, [306](#)

Tip/ring (T/R) interface, see Multi-Function Module (MFM)

Toll Restriction, see Calling restrictions

Toll Type, [714](#) to [715](#)

Toll Type, feature interactions

- Allowed/Disallowed Lists, [48](#), [715](#)
- Automatic Route Selection (ARS), [94](#), [715](#)

Touch-tone or rotary signaling, [716](#) to [722](#)

Touch-tone receivers (TTRs), [366](#), [370](#), [717](#) to [722](#)

- 008 OPT modules, [721](#)
- 400 GS/LS modules, [721](#)
- 800 DID modules, [721](#)
- 800 LS-ID modules, [721](#)
- calculating system requirements, [720](#) to [721](#)
- required by voice mail/auto attendant, [719](#)

Touch-tone receivers (TTRs), see also Touch-tone or rotary signaling and Appendix I

Transfer

- description, [723](#) to [756](#)
- one-touch, [726](#) to [727](#)
- options, [725](#) to [728](#)
- return time, [725](#) to [726](#)
- transfer returns across a private network, [725](#)

Transfer Audible, [454](#) to [456](#)

Transfer, feature interactions

- Account Code Entry/Forced Account Code Entry, [36](#), [733](#)
- Authorization Code, [55](#), [733](#)
- Auto Dial, [68](#), [733](#)
- Automatic Line Selection, [74](#), [733](#)
- Basic Rate Interface (BRI), [109](#), [733](#)
- Call Waiting, [115](#), [734](#)
- Callback, [124](#), [733](#)
- Caller ID, [131](#), [733](#)
- Camp-On, [143](#), [734](#)
- Centrex operation, [157](#)
- Computer Telephony Integration (CTI) link, [222](#), [734](#)
- Conference, [169](#), [734](#)
- Coverage, [207](#), [734](#)
- digital data calls, [230](#), [735](#)
- Direct Station Selector (DSS), [258](#), [735](#)
- Direct Voice Mail, [262](#), [735](#)
- Direct-Line Console (DLC), [239](#)
- Display, [306](#), [735](#)
- Do Not Disturb, [315](#), [736](#)
- Fax Extension, [324](#), [736](#)
- Forward and Follow Me, [349](#), [736](#)
- Group Calling, [387](#), [736](#)
- Headset options, [394](#), [736](#)
- Hold, [403](#), [736](#)
- HotLine, [407](#), [737](#)
- Inspect, [412](#), [737](#)
- Last Number Dial, [426](#), [737](#)
- Line Request, [428](#), [737](#)
- Messaging, [443](#), [737](#)
- Microphone Disable, [445](#), [737](#)
- Multi-Function Module (MFM), [453](#), [737](#)
- Music On Hold, [457](#), [737](#)
- Paging, [478](#), [738](#)
- Park, [483](#), [738](#)
- personal lines, [492](#), [738](#)
- Pickup, [499](#), [738](#)
- Primary Rate Interface (PRI) and T1, [552](#), [738](#)
- Queued Call Console (QCC), [589](#)
- Recall/Timed Flash, [597](#), [738](#)
- Ringling Options, [625](#), [738](#)
- Saved Number Dial, [629](#), [738](#)
- Signal/Notify, [644](#), [647](#), [739](#)
- Speed Dial, [654](#), [739](#)
- Station Message Detail Recording (SMDR), [671](#), [739](#)
- System Access/Intercom buttons, [684](#), [739](#)
- UDP features, [740](#), [755](#)

TransTalk 9000 Digital Wireless System, [I-33](#)

Troubleshooting

- misrouting of intersystem calls, [745](#)

Trunk Pools, see Pools

Trunk-to-trunk transfer, see also Transfer

TSAPI, [GL-28](#)

- TTRs
- requirements for primary delay announcement devices, [720](#)
 - requirements for secondary delay announcement devices, [720](#)
 - requirements for voice messaging systems, [719](#)
 - system requirements, [719](#)
- TTRs, see Touch-tone receivers (TTRs)
-

U

- UDC/DDC, see Group Calling
- UDP features, [741](#) to ??, [756](#) to ??
- UDP features, feature interactions
- Account Code Entry/Forced Account Code Entry, [36](#), [749](#)
 - Alarm, [39](#), [749](#)
 - Auto Answer Intercom, [61](#), [749](#)
 - Auto Dial, [68](#), [749](#)
 - Barge-In, [98](#), [749](#)
 - Callback, [124](#), [750](#)
 - Caller ID, [131](#), [750](#)
 - calling restrictions, [139](#), [750](#)
 - Camp-On, [143](#), [750](#)
 - Computer Telephony Integration (CTI) link, [222](#), [751](#)
 - Conference, [169](#), [750](#)
 - Coverage, [207](#), [751](#)
 - Direct Station Selector (DSS), [259](#)
 - Direct Voice Mail, [752](#)
 - Direct-Line Console (DLC), [239](#)
 - Directories, [270](#), [752](#)
 - Display, [752](#)
 - Forward and Follow Me, [349](#), [752](#)
 - Group Calling, [387](#), [753](#)
 - Hands-Free Answer on Intercom (HFAI), [753](#)
 - HotLine, [407](#), [753](#)
 - Labeling, [417](#), [753](#)
 - Messaging, [443](#), [753](#)
 - Music On Hold, [457](#), [754](#)
 - Night Service, [468](#), [754](#)
 - Paging, [478](#), [754](#)
 - Park, [754](#)
 - personal lines, [754](#)
 - Pickup, [499](#), [754](#)
 - Pools, [506](#), [754](#)
 - Reminder service, [601](#), [755](#)
 - Signal/Notify, [644](#), [647](#), [755](#)
 - Speed Dial, [654](#), [755](#)
 - Station Message Detail Recording (SMDR), [672](#), [755](#)
 - System Renumbering, [697](#), [755](#)
 - Transfer, [740](#), [755](#)
- UDP routing, [747](#)
- Uniform Dial Plan (UDP) features, see UDP features

V

Videoconferencing, see Digital data calls, Appendix I

VMI (voice messaging interface) ports, see Voice messaging interface (VMI) ports

Voice Announce, [757](#) to [760](#)

Voice announce, [471](#)

Voice announce disable, see Voice Announce to Busy

Voice Announce on Idle Only, [758](#)

Voice Announce to Busy, feature interactions

 Coverage, [760](#)

 digital data calls, [760](#)

 Do Not Disturb, [760](#)

 Microphone Disable, [760](#)

 Multi-Function Module (MFM), [453](#), [760](#)

 Paging, [760](#)

Voice Announce, feature interactions

 Auto Answer All, [58](#)

 Coverage, [207](#)

 digital data calls, [230](#)

 Do Not Disturb, [315](#)

 Forward and Follow Me, [349](#)

 Microphone Disable, [445](#)

 Paging, [478](#)

 Queued Call Console (QCC), [589](#)

Voice announce, see also Shared Access/Intercom buttons, Paging

Voice mail systems, see Voice messaging systems, Integrated Administration, Appendix I

Voice mail/auto attendant

 touch-tone receivers (TTRs) required, [719](#)

Voice messaging interface (VMI) ports, [45](#), [83](#), [134](#), [135](#), [372](#), [443](#)

Voice messaging interface (VMI) ports, feature interactions

 tandem switching, [711](#)

Voice messaging systems, [190](#) to [195](#), [409](#)

Voice messaging systems, see also Appendix I

W

Windows NT 4.0 Server, [210](#)

WinSPM, [561](#), [I-29](#)

 language, [420](#)