

Lucent Technologies
Bell Labs Innovations



MERLIN LEGEND®
Communications System
Release 7.0

System Planning

555-670-112
Comcode 108370289
Issue 1
April 1999

Copyright © 1999, Lucent Technologies

All Rights Reserved

Printed in USA

555-670-112

Comcode 108370289

Issue 1

April 1999

Notice

Every effort has been made to ensure that the information in this guide is complete and accurate at the time of printing. Information, however, is subject to change. See Appendix A, "Customer Support Information," in *System Programming* for important information.

Your Responsibility for Your System's Security

Toll fraud is the unauthorized use of your telecommunications system by an unauthorized party—for example, persons other than your company's employees, agents, subcontractors, or persons working on your company's behalf. Note that there may be a risk of toll fraud associated with your telecommunications system, and, if toll fraud occurs, it can result in substantial additional charges for your telecommunications services.

You and your system manager are responsible for the security of your system, such as programming and configuring your equipment to prevent unauthorized use. The system manager is also responsible for reading all installation, instruction, and system administration documents provided with this product in order to fully understand the features that can introduce risk of toll fraud and the steps that can be taken to reduce that risk. Lucent Technologies does not warrant that this product is immune from or will prevent unauthorized use of common-carrier telecommunication services or facilities accessed through or connected to it. Lucent Technologies will not be responsible for any charges that result from such unauthorized use. For important information regarding your system and toll fraud, see Appendix A, "Customer Support Information," in *System Programming*.

Federal Communications Commission Statement

This equipment has been tested and found to comply with the limits for a Class A digital device, pursuant to Part 15 of the FCC Rules. These limits are designed to provide reasonable protection against harmful interference when the equipment is operated in a commercial environment. This equipment generates, uses, and can radiate radio frequency energy and, if not installed and used in accordance with the instruction manual, may cause harmful interference to radio communications. Operation of this equipment in a residential area is likely to cause harmful interference, in which case the user will be required to correct the interference at their own expense. For further FCC information, see Appendix A, "Customer Support Information," in *System Programming*.

Canadian Department of Communications (DOC) Interference Information

This digital apparatus does not exceed the Class A limits for radio noise emissions set out in the radio interference regulations of the Canadian Department of Communications.

Le Présent Appareil Numérique n'émet pas de bruits radioélectriques dépassant les limites applicables aux appareils numériques de la classe A prescrites dans le règlement sur le brouillage radioélectrique édicté par le ministère des Communications du Canada.

Year 2000 Compliance

The MERLIN LEGEND Communications System is certified to be Year 2000 compliant. Additional information on this certification, and other issues regarding Year 2000 compliance, is available online at <http://www.lucent.com/enterprise/sig/yr2000>.

Trademarks

5ESS, AUDIX, CONVERSANT, CentreVu, DEFINITY, Magic On Hold, MERLIN, MERLIN LEGEND, MERLIN Mail, PARTNER, PassageWay, MLX-10, MLX-10D, MLX-10DP, MLX-16DP, MLX-20L, MLX-28D, MLS-6, MLS-12, MLS-12D, MLS-18D, MLS-34D, SYSTIMAX, TransTalk, and Voice Power are registered trademarks and 4ESS, Intuity, Lucent Technologies, and Prologix are trademarks of Lucent Technologies in the US and other countries.

Acculink, ACCUNET, MEGACOM, MultiQuest, MLX-5, MLX-5D, and NetPROTECT are registered trademarks of AT&T.

Microsoft, Windows, Windows NT, and MS-DOS are registered trademarks of Microsoft Corporation.

ProComm and ProComm Plus are registered trademarks of DataStorm Technologies, Inc.

Supra, Supra NC, StarSet, and Mirage are registered trademarks of Plantronics, Inc.

UNIX is a registered trademark of UNIX System Laboratories, Inc.

PagePac is a registered trademark and Powermate and Zonemate are trademarks of DRACON, a division of Harris Corporation.

Okidata is a registered trademark of Okidata Corporation.

Pipeline is a trademark of Ascend Communications, Inc.

Intel and Pentium are registered trademarks of Intel Corporation.

Apple and Macintosh are registered trademarks of Apple Computer, Inc.

IBM is a registered trademark of International Business Machines, Inc.

Novell and NetWare are registered trademarks of Novell Corporation.

CLASS is a servicemark of Bellcore.

Ordering Information

Call: BCS Publications Center
Voice 1-800-457-1235 International Voice 317-322-6791
Fax 1-800-457-1764 International Fax 317-322-6699

Write: BCS Publications Center
2855 North Franklin Road
Indianapolis, IN 46219-1385

Order: Document No. 555-670-112
Comcode: 108370289
Issue 1, April 1999

For more information about Lucent Technologies documents, refer to the section entitled "Related Documents" in "About This Guide" in *System Programming*.

Support Telephone Number

In the continental US, Lucent Technologies provides a toll-free customer helpline 24 hours a day. Call the Lucent Technologies Helpline at **1-800-628-2888** or your Lucent Technologies authorized dealer if you need assistance when installing, programming, or using your system. Outside the continental US, contact your local Lucent Technologies authorized representative.

Network Engineering Group

For assistance in designing a private network, call the Network Engineering Group at **1-888-297-4700**.

Lucent Technologies Corporate Security

Whether or not immediate support is required, all toll fraud incidents involving Lucent Technologies products or services *should be reported* to Lucent Technologies Corporate Security at **1-800-821-8235**. In addition to recording the incident, Lucent Technologies Corporate Security is available for consultation on security issues, investigation support, referral to law enforcement agencies, and educational programs.

Lucent Technologies Fraud Intervention

If you *suspect you are being victimized* by toll fraud and you need technical support or assistance, call BCS National Service Assistance Center at **1-800-628-2888**.

Warranty

Lucent Technologies provides a limited warranty on this product. Refer to "Limited Warranty and Limitation of Liability" in Appendix A, "Customer Support Information," of *System Programming*.

Contents

[New Features and Enhancements](#) [xxi](#)

- [Release 7.0 Enhancements](#)
[\(April 1999\)](#) [xxi](#)
 - [MLS and Enhanced Tip/Ring \(ETR\) Telephone Support](#) [xxi](#)
 - [Expanded Digital Endpoint Connectivity](#) [xxii](#)
 - [Voice Announce on Idle Only Option on MLX Telephones](#) [xxii](#)
 - [Priority Call Queuing](#) [xxiii](#)
 - [Calling Party Name on Caller ID](#) [xxiii](#)
 - [MLX Headset Operation](#) [xxiv](#)
 - [Touch-Tone or Rotary Signaling](#) [xxiv](#)
 - [Abandoned Call Information Reported to MERLIN LEGEND Reporter](#) [xxiv](#)
-

[Prior Releases: Features and Enhancements](#) [xxv](#)

- [Release 6.1 Enhancements](#)
[\(August 1998\)](#) [xxv](#)
 - [Private Networking](#) [xxv](#)
 - [Service Observing](#) [xxviii](#)
 - [WinSPM](#) [xxviii](#)
 - [Windows NT Driver](#) [xxviii](#)
- [Release 6.0 Enhancements](#)
[\(February 1998\)](#) [xxix](#)
 - [Private Networks](#) [xxix](#)
 - [Group Calling Enhancements](#) [xxx](#)
 - [Centrex Transfer via Remote Call Forwarding](#) [xxxii](#)
 - [Authorization Codes and Remote Call Forwarding](#) [xxxii](#)
- [Release 5.0 Enhancements](#)
[\(June 1997\)](#) [xxxiii](#)
 - [Computer Telephony Integration \(CTI\)](#) [xxxiii](#)
 - [HotLine Feature](#) [xxxv](#)
 - [Group Calling Enhancements](#) [xxxvi](#)
 - [MLX-5 and MLX-5D Telephones](#) [xxxvii](#)

■ Release 4.2 Enhancements (June 1997)	xxxviii
Additional Network Switch and Services Options for ISDN Primary Rate Interface (PRI)	xxxviii
Improvements to Station Message Detail Recording (SMDR) and Support for MERLIN LEGEND Reporter Application	xxxix
MERLIN LEGEND Reporter	xl
Maintenance Enhancements	xl
■ Release 4.1 Enhancements (June 1997)	xl
Coverage Timers Programmed for Individual Extensions	xli
Night Service with Coverage Control	xli
Night Service Group Line Assignment	xli
Forward on Busy	xlii
Maintenance Testing for BRI Facilities that Are Part of Multiline Hunt Groups (MLHG)	xlii
■ Release 4.0 Enhancements (March 1996)	xliii
Support for Up to 200 Extensions	xliii
Support for National ISDN BRI Service	xliii
New Control Unit Modules	xliii
Support for 2B Data Applications	xliv
Support for T1 Switched 56 Digital Data Transmission	xliv
Forwarding Delay Option	xliv
Voice Announce on Queued Call Console	xliv
Time-Based Option for Overflow on Calling Group	xlv
Single-Line Telephone Enhancements	xlv
Seven-Digit Password for SPM	xlv
■ Release 3.1 Enhancements (March 1996)	xlv
Call Restriction Checking for Star Codes	xlv
Trunk-to-Trunk Transfer Set for Each Extension	xlv
Programmable Second Dial Tone Timer	xlv
Security Enhancements	xlv
■ Release 3.0 Enhancements (August 1994)	xlviii

Equipment	xlviii
Installation, Upgrade Administration, and Maintenance	xlix
User Features	xlix
Additional Application Packages, Adjuncts, and Adapter Enhancements	li
■ Release 2.1 Enhancements (August 1994)	lii
Operational	lii
Installation and Hardware	liii
Equipment and Operations	liv
Additional Application Packages, Telephones, Adjuncts, and Adapter	liv
■ Release 2.0 Enhancements (October 1992)	lv
Programming	lv
Operational	lvi
Fax Attendant System™	lvii
408 GS/LS-MLX Module	lvii
Primary Rate Interface (PRI)	lvii
Maintenance	lviii
■ Release 1.1 Enhancements (October 1992)	lviii
Language Selection	lviii
Programming and Maintenance	lix
Operational	lix
SPM	lix
Equipment	lix
PF Registration	lix

[About This Guide](#) [lxi](#)

■ Intended Audience	lxi
■ How to Use This Guide	lxi
■ Terms and Conventions Used	lxii
Typographical Conventions	lxiv
Product Safety Advisories	lxiv
■ Security	lxiv
■ Related Documents	lxv
■ How to Comment on This Guide	lxvii

<u>1</u>	<u>Before You Begin</u>	<u>1-1</u>
	■ <u>Reviewing System Components</u>	<u>1-1</u>
	■ <u>Confirming the Location of the Control Unit</u>	<u>1-2</u>
	<u>Grounding Requirements</u>	<u>1-4</u>
	<u>Electrical Noise/Radio-Frequency Interference</u>	<u>1-5</u>
	■ <u>Requirements for Supporting CTI Applications</u>	<u>1-6</u>
	<u>Environmental Specifications</u>	<u>1-9</u>
	■ <u>Obtaining Telephone Company Information</u>	<u>1-10</u>
	■ <u>Obtaining User Information</u>	<u>1-10</u>
	■ <u>Obtaining a Floor Plan</u>	<u>1-12</u>
<hr/>		
<u>2</u>	<u>Control Unit Configuration</u>	<u>2-1</u>
	■ <u>Planning Module Placement</u>	<u>2-1</u>
	<u>Capacity for Lines/Trunks</u>	<u>2-2</u>
	<u>Capacity for Extensions</u>	<u>2-2</u>
	<u>Control Unit Diagram—Module Placement</u>	<u>2-4</u>
	■ <u>Recording System Operating Conditions</u>	<u>2-7</u>
	<u>Programming Equipment</u>	<u>2-8</u>
	<u>System Mode</u>	<u>2-9</u>
	<u>Language Selection</u>	<u>2-10</u>
	<u>Automatic Maintenance Busy</u>	<u>2-10</u>
	<u>Set System Date</u>	<u>2-11</u>
	<u>Backup</u>	<u>2-11</u>
	<u>System Consoles</u>	<u>2-12</u>
	<u>Second Dial Tone Timer</u>	<u>2-12</u>
	<u>Applications</u>	<u>2-12</u>
	■ <u>Numbering the System</u>	<u>2-13</u>
	<u>Identifying Extension Jacks</u>	<u>2-14</u>
	<u>System Renumbering</u>	<u>2-36</u>
	<u>Updating Planning Information</u>	<u>2-40</u>
<hr/>		
<u>3</u>	<u>Lines/Trunks</u>	<u>3-1</u>
	■ <u>Overview</u>	<u>3-1</u>
	■ <u>Identifying Line/Trunk Jacks</u>	<u>3-2</u>
	<u>Module Types and Line/Trunk Jack Types</u>	<u>3-2</u>

<u>Incoming Line/Trunk Type</u>	3-7
<u>Jacks for Auxiliary Equipment</u>	3-9
<u>Function Information</u>	3-10
■ <u>Selecting Line/Trunk Options</u>	3-11
<u>Loop-Start Reliable Disconnect</u>	3-12
<u>Outmode Signaling</u>	3-13
<u>Toll Type Prefix Required</u>	3-14
<u>Hold Disconnect Interval</u>	3-14
<u>QCC Operator to Receive Calls</u> (Hybrid/PBX Mode Only)	3-15
<u>QCC Queue Priority Level (Hybrid/PBX Mode Only)</u>	3-15
<u>Pools (Hybrid/PBX Mode Only)</u>	3-16
<u>Remote Access</u>	3-17
<u>DS1 Connectivity (100D Module)</u>	3-23
<u>Tie Trunks</u>	3-40
<u>DID Trunks (Hybrid/PBX Mode Only)</u>	3-44
<u>NI-1 BRI Connectivity</u>	3-46
■ <u>Assigning Lines/Trunks</u>	3-52
■ <u>Assigning Telephone Buttons</u>	3-53
<u>Telephones in Hybrid/PBX Mode</u>	3-54
<u>Telephones in Key and Behind Switch Mode</u>	3-61
<u>Direct-Line Consoles</u>	3-72

<u>4</u>	<u>Features</u>	<u>4-1</u>
■	<u>Telephone and Extension Features</u>	<u>4-2</u>
	<u>Queued Call Console (Hybrid/PBX Mode Only)</u>	<u>4-3</u>
	<u>Pool Dial-Out Code Restriction</u> (Hybrid/PBX Mode Only)	<u>4-4</u>
	<u>Calling Restrictions</u>	<u>4-4</u>
	<u>Forced Account Code Entry</u>	<u>4-5</u>
	<u>Microphone Operation</u>	<u>4-6</u>
	<u>Remote Call Forwarding</u>	<u>4-6</u>
	<u>Fax Message-Waiting Receiver</u>	<u>4-7</u>
	<u>Trunk-to-Trunk Transfer</u>	<u>4-8</u>
	<u>HotLine</u>	<u>4-9</u>
	<u>Extension Copy</u>	<u>4-9</u>
	<u>Cover Ring Delay</u>	<u>4-13</u>

Service Observing	4-14
■ Operator Features	4-16
Direct-Line Console	4-16
Queued Call Console (Hybrid/PBX Mode Only)	4-17
Direct Station Selector	4-23
■ Group-Assigned Features	4-24
Call Pickup Groups	4-25
Group Paging	4-25
Coverage	4-26
Group Calling	4-30
■ System Features	4-40
Transfer Options	4-41
Camp-On Return Time	4-42
Call Park Return Time	4-43
Automatic Callback	4-43
Extension Status	4-43
Station Message Detail Recording (SMDR)	4-44
Inside Dial Tone	4-46
Reminder Service Cancel	4-46
Calls to Unassigned Extensions	4-47
Recall Timer	4-48
Interdigit Timers	4-49
Rotary	4-49
Allowed Lists	4-49
Disallowed Lists	4-51
Call Restriction Summary	4-52
Night Service	4-53
Labeling	4-56
Automatic Route Selection (Hybrid/PBX Mode Only)	4-59

5	Data Communications	5-1
■	Overview	5-1
■	Terminology	5-2
■	About Data and Video Communications	5-4
	Connectivity	5-4
	Data Stations	5-5
	Modem Data Stations	5-6

	Modem Data-Only	5-8
	MLX Voice and Modem Data	5-8
	Other Supported Data Terminals	5-13
	Other Resource Groups	5-13
	Video Systems	5-14
■	Planning Overview	5-16
■	Assigning Extension Jacks	5-19
	Guidelines for Digital Extension Jacks	5-20
	Modem Data-Only Stations	5-21
	ISDN Terminal Adapter Data-Only Stations	5-22
	Local Host Computer Data Stations	5-22
	LAN Workstations	5-23
	Video Systems	5-24
■	Assigning Lines/Trunks to Data and Video Stations	5-25
	Assigning Line Buttons in Hybrid/PBX Mode	5-29
	Assigning Pools and Lines/Trunks (Hybrid/PBX Mode Only)	5-31
	Assigning Line Buttons in Key Mode	5-32
■	Assigning Features to Data Stations	5-33
	Pool Dial-Out Code (Hybrid/PBX Mode Only)	5-35
	Calling Restrictions	5-35
	Forced Account Code Entry	5-36
	ARS Facility Restriction Level (Hybrid/PBX Mode Only)	5-36
	System Speed Dial Codes	5-37
■	Creating Data Hunt Groups	5-37
	Guidelines	5-38
■	Digital Data/Video Stations	5-39

6	Modifications	6-1
■	Preparation	6-1
■	Adding to the System	6-2

7	Upgrading	7-1
■	Upgrading to Release 7.0	7-2
	Upgrade Procedure	7-3
■	Release 7.0 Forms	7-5

<u>A</u>	<u>Customer Support Information</u>	<u>A-1</u>
	■ <u>Support Telephone Number</u>	<u>A-1</u>
	■ <u>Federal Communications Commission (FCC) Electromagnetic Interference Information</u>	<u>A-1</u>
	■ <u>Canadian Department of Communications (DOC) Interference Information</u>	<u>A-2</u>
	■ <u>FCC Notification and Repair Information</u>	<u>A-2</u>
	■ <u>Installation and Operational Procedures</u>	<u>A-4</u>
	■ <u>DOC Notification and Repair Information</u>	<u>A-5</u>
	■ <u>Renseignements sur la Notification du Ministère des Communications du Canada et la Réparation</u>	<u>A-6</u>
	■ <u>Security of Your System: Preventing Toll Fraud</u>	<u>A-9</u>
	■ <u>Toll Fraud Prevention</u>	<u>A-10</u>
	<u>Physical Security, Social Engineering, and General Security Measures</u>	<u>A-11</u>
	<u>Security Risks Associated with Transferring through Voice Messaging Systems</u>	<u>A-12</u>
	<u>Security Risks Associated with the Automated Attendant Feature of Voice Messaging Systems</u>	<u>A-14</u>
	<u>Security Risks Associated with the Remote Access Feature</u>	<u>A-15</u>
	■ <u>Other Security Hints</u>	<u>A-16</u>
	<u>Educating Users</u>	<u>A-16</u>
	<u>Educating Operators</u>	<u>A-17</u>
	<u>Detecting Toll Fraud</u>	<u>A-17</u>
	<u>Establishing a Policy</u>	<u>A-18</u>
	<u>Choosing Passwords</u>	<u>A-19</u>
	<u>Physical Security</u>	<u>A-19</u>
	<u>Limiting Outcalling</u>	<u>A-19</u>
	■ <u>Limited Warranty and Limitation of Liability</u>	<u>A-20</u>
	<u>Limitation of Liability</u>	<u>A-21</u>
	■ <u>Remote Administration and Maintenance</u>	<u>A-21</u>

<u>B</u>	<u>System Forms</u>	<u>B-1</u>
-----------------	----------------------------	-------------------

<u>C</u>	<u>Data Forms</u>	<u>C-1</u>
-----------------	--------------------------	-------------------

Figures

1 Before You Begin

1-1	System Configuration for Support of CTI Applications	1-7
1-2	Sample Floor Plan	1-14

2 Control Unit Configuration

2-1	Sample Control Unit Diagram	2-7
2-2	Extension Numbers for 2-Digit Numbering Plan	2-37
2-3	Extension Numbers for 3-Digit Numbering Plan	2-37
2-4	Extension Numbers for Set Up Space Numbering Plan	2-38

3 Lines/Trunks

3-1	Partially Completed System Form 2c	3-9
3-2	Factory-Set Assignment, MLX Telephones (Hybrid/PBX Mode)	3-54
3-3	Factory-Set Assignment, Analog Multiline Telephones (Hybrid/PBX Mode)	3-55
3-4	ETR-34D Telephone (Hybrid/PBX Mode)	3-56
3-5	ETR-18/18D Telephone (Hybrid/PBX Mode)	3-56
3-6	ETR-6 Telephone (Hybrid/PBX Mode)	3-57
3-7	MLS-34D Telephone (Hybrid/PBX Mode)	3-57
3-8	MLS-18D Telephone (Hybrid/PBX Mode)	3-57
3-9	MLS-12/12D, TransTalk, or Business Cordless 905 Telephone (Hybrid/PBX Mode)	3-58
3-10	MLS-6 Telephone (Hybrid/PBX Mode)	3-58

3-11	Factory-Set Assignment, MLX Telephones (Key and Behind Switch Modes)	3-62
3-12	Factory-Set Assignment, Analog Multiline Telephones (Key and Behind Switch Modes)	3-63
3-13	ETR-34D Telephone (Key Mode)	3-64
3-14	ETR-18/18D Telephone (Key Mode)	3-64
3-15	ETR-6 Telephone (Key Mode)	3-65
3-16	MLS-34D Telephone (Key Mode)	3-65
3-17	MLS-18D Telephone (Key Mode)	3-65
3-18	MLS-12/12D, TransTalk, or Business Cordless 905 Telephone (Key Mode)	3-66
3-19	MLS-6 Telephone (Key Mode)	3-66
3-20	ETR-34D Telephone (Behind Switch Mode)	3-66
3-21	ETR-18/18D Telephone (Behind Switch Mode)	3-67
3-22	ETR-6 Telephone (Behind Switch Mode)	3-67
3-23	MLS-34D Telephone (Behind Switch Mode)	3-68
3-24	MLS-18D Telephone (Behind Switch Mode)	3-68
3-25	MLS-12/12D Telephone (Behind Switch Mode)	3-69
3-26	MLS-6 Telephone (Behind Switch Mode)	3-69
3-27	MLX Direct-Line Console	3-73
3-28	Analog Direct-Line Console	3-74

4 Features

4-1	Completed ARS Worksheet—Automatic Route Selection Tables	4-62
4-2	Example 1: Form 3f, 6-Digit Table	4-65
4-3	Example 2: Form 3f, Area Code Table	4-66
4-4	Subpattern Example	4-68
4-5	Other Digits Example	4-69
4-6	Digit Absorption Example	4-70

5 Data Communications

5-1	Analog Voice and Modem Data	5-7
5-2	Modem Data-Only	5-8
5-3	MLX Voice and Modem Data	5-9
5-4	MLX Voice and ISDN Terminal Adapter Data	5-10
5-5	ISDN Terminal Adapter Data-Only	5-11
5-6	Personal and Group Video Connections	5-16

Tables

1 Before You Begin

1-1	Environmental Requirements	1-2
1-2	Control Unit Space Requirements	1-4
1-3	Employee Communications Survey: Description of Questions	1-11

2 Control Unit Configuration

2-1	Power Supplies and MLX, ETR, and MLS Telephones	2-6
2-2	Application Ports	2-15
2-3	Modules with Touch-Tone Receivers	2-19
2-4	Touch-Tone Receivers Required by Voice Messaging Systems	2-19
2-5	System Requirements for Touch-Tone Receivers	2-20
2-6	TTRs Required for Primary Delay Announcement Devices	2-21
2-7	TTRs Required for Secondary Delay Announcement Devices	2-21
2-8	Maximum Number of Operator Positions	2-24
2-9	Application Ports	2-33

3 Lines/Trunks

3-1	Line/Trunk Jack Types	3-3
3-2	Codes for Line/Trunk Jacks	3-6
3-3	Line Compensation Settings	3-27

3-4	Line Compensation Settings	3-33
3-5	NI-1 BRI Timers	3-51

4 Features

4-1	Features that Can Be Copied	4-10
-----	-----------------------------	------

5 Data Communications

5-1	Data Station Configurations	5-12
5-2	Data Forms	5-17
5-3	System Forms	5-18
5-4	Extension Jack Types	5-20

6 Modifications

6-1	Adding New Trunks	6-5
6-2	Adding Auxiliary Equipment	6-5
6-3	Adding New Extensions	6-6

7 Upgrading

7-1	Planning Forms	7-5
-----	----------------	-----

F Unit Load Calculation

F-1	Power Supplies and MLX, ETR, and MLS Telephones	F-2
-----	---	-----

IMPORTANT SAFETY INSTRUCTIONS



The exclamation point in an equilateral triangle is intended to alert the user to the presence of important operating and maintenance (servicing) instructions in the literature accompanying the product.

To reduce the risk of fire, electrical shock, and injury to persons, follow these basic safety precautions when installing telephone equipment:

- Read and understand all instructions.
- Follow all warnings and instructions marked on or packed with the product.
- Never install telephone wiring during a lightning storm.
- Never install a telephone jack in a wet location unless the jack is specifically designed for wet locations.
- Never touch uninsulated telephone wires or terminals unless the telephone wiring has been disconnected at the network interface.
- Use caution when installing or modifying telephone lines.
- Use only Lucent Technologies-manufactured MERLIN LEGEND Communications System circuit modules, carrier assemblies, and power units in the MERLIN LEGEND Communications System control unit.
- Use only Lucent Technologies-recommended/approved MERLIN LEGEND Communications System accessories.
- If equipment connected to the analog extension modules [008 (ATL), 408 (LS-ATL), and 408 GS/LS], the MLX telephone modules (008 MLX, 408 GS/LS-MLX, 408 GS/LS-ID-MLX, and 016 MLX), or the ETR telephone modules (412 LS-ID-ETR and 016 ETR) is to be used for in-range out-of-building (IROB) applications, IROB protectors are required.
- Do not install this product near water—for example, in a wet basement location.
- Do not overload wall outlets, as this can result in the risk of fire or electrical shock.
- The MERLIN LEGEND Communications System is equipped with a 3-wire grounding-type plug with a third (grounding) pin. This plug will fit only into a grounding-type power outlet. This is a safety feature. If you are unable to insert the plug into the outlet, contact an electrician to replace the obsolete outlet. Do not defeat the safety purpose of the grounding plug.
- The MERLIN LEGEND Communications System requires a supplementary ground.
- Do not attach the power supply cord to building surfaces. Do not allow anything to rest on the power cord. Do not locate this product where the cord will be abused by persons walking on it.

- Slots and openings in the module housings are provided for ventilation. To protect this equipment from overheating, do not block these openings.
- Never push objects of any kind into this product through module openings or expansion slots, as they may touch dangerous voltage points or short out parts, which could result in a risk of fire or electrical shock. Never spill liquid of any kind on this product.
- Unplug the product from the wall outlet before cleaning. Use a damp cloth for cleaning. Do not use cleaners or aerosol cleaners.
- Auxiliary equipment includes answering machines, alerts, modems, and fax machines. To connect one of these devices, you must first have a Multi-Function Module (MFM).
- Do not operate telephones if chemical gas leakage is suspected in the area. Use telephones located in some other safe area to report the trouble.



WARNING:

- For your personal safety, DO NOT install an MFM yourself.
- ONLY an authorized technician or dealer representative shall install, set options, or repair an MFM.
- To eliminate the risk of personal injury due to electrical shock, DO NOT attempt to install or remove an MFM from your MLX telephone. Opening or removing the module cover of your telephone may expose you to dangerous voltages.

SAVE THESE INSTRUCTIONS

New Features and Enhancements

Release 7.0 Enhancements (April 1999)

Release 7.0 includes all Release 6.1 functionality, plus the enhancements listed below. For a description of features and enhancements in prior releases, see “Prior Releases: Features and Enhancements” in *System Programming*.

MLS and Enhanced Tip/Ring (ETR) Telephone Support

One of the most important new capabilities of MERLIN LEGEND Release 7.0 is its support for MLS and ETR telephones, allowing existing customers with either telephones the ability to migrate to a MERLIN LEGEND Communications System. The MLS telephones include the MLS-6[®], MLS-12[®], MLS-12D[®], MLS-18D[®], and MLS-34D[®]. The ETR telephones include the ETR-6, ETR-18, ETR-18D, and ETR-34D. The Business Cordless 905 telephone and the TransTalk™ 9000 Digital Wireless System are also supported.

The MLS, ETR, and Business Cordless 905 telephones, as well as the TransTalk 9000 Digital Wireless System, require ETR station ports. To provide support for these telephones and for the TransTalk 9000 system, two new modules have been designed:

- **412 LS-ID-ETR Module.** The 412 LS-ID-ETR module provides 4 LS trunks with Caller ID and 2 touch tone receivers (TTRs) plus 12 ETR station ports, including 4 with Tip/Ring (T/R) functionality. On the 412 LS-ID-ETR module, the first 8 ports are ETR ports only—these ports do not have T/R functionality. The remaining 4 ports (ports 9 through 12) can be programmed to support either T/R or ETR, but not both simultaneously. This module does not have a separate PFT port. In the event of a power

failure, port 12 becomes the PFT port for line 1. If the port is programmed for ETR operation, a single-line telephone must be plugged into the port for operation during power failure.

If caller identification is subscribed to from the local telephone company, the 412 LS-ID-ETR module displays the telephone number of incoming callers (from supported areas) on ETR and MLS display telephones. In addition, a button on the ETR and MLS telephone can be programmed to toggle between displaying caller name or caller number.

- **016 ETR Module.** The 016 ETR module provides 16 ETR station ports, including 6 with T/R functionality and 4 TTRs. On the 016 ETR module, the first 10 ports are ETR ports only—these ports do not have T/R functionality. The remaining 6 ports (ports 11 through 16) can be programmed to support either T/R or ETR, but not both simultaneously.

Expanded Digital Endpoint Connectivity

Release 7.0 increases the maximum number of digital telephones supported from 127 to 200 by introducing a new 016 MLX module. In addition, each of the 200 ports can support an MFM adjunct which increases the current 255 station endpoints to 400.

- **016 MLX Module.** Each 016 MLX module provides 16 digital station ports and has an additional 32K of dual port RAM.
- **Processor Module.** The 016 MLX module can only be utilized with the CKE4 or later processor module with upgrade to R7.0 software. The CKE4 processor module provides the lead to access the additional 32K of RAM on the 016 MLX module.

Voice Announce on Idle Only Option on MLX Telephones

Prior to Release 7.0, no options were available for disabling intercom voice announcements at an MLX telephone when busy. In Release 7.0, a new option—Voice Announce on IDLE ONLY—is available with the existing Voice Announce feature. This new option allows a user to receive intercom voice announcements only when they are not active on another call.

Priority Call Queuing

Priority call queuing provides the ability to:

- Place some callers ahead of others who are waiting for the same agent group.
- Give key clients priority over others.
- Automatically increase the number of agents answering calls during busy times, while continuing to offer callers the choice to leave a message instead of waiting.
- Keep costs down by handling toll free calls (calls arriving on 800 and 888 lines) before processing calls on local lines.

Priority call queuing is accomplished in Release 7.0 by allowing you to define a supportive relationship between calling groups. Calls that arrive in one calling group can be processed by another calling group when no one from the first calling group is available to answer the call. Through system programming, a calling group can be assigned a priority level between 1 (highest priority) and 32 (lowest priority) and then designated as a support group for another group.

Calling Party Name on Caller ID

Release 7.0 continues to support Calling Party Number and adds a new functionality for Calling Party Name. By programming a button on the telephone or with a feature code through centralized programming, users are able to toggle between displaying the caller's telephone number or the caller's name. In order to use this feature, users must subscribe to caller identification from their local exchange carrier (LEC).

Calling Party Name can be 15 characters in length for MLX telephones as well as for ETR and MLS telephones. Calling Party Name is not recorded on SMDR reports. In addition, neither Calling Party Name nor Calling Party Number are displayed on analog multiline telephones.

This feature requires loop-start (LS) trunks. The existing LS-ID delay feature must be programmed for each line, as well. This prevents Calling Party Number and Name information from being lost when a call is answered too quickly.

Release 7.0 software also supports the Caller ID capability of the 408 GS/LS-ID-MLX module. Although previously orderable, the Caller ID capability of this module could not be used until Release 7.0 software became available.

MLX Headset Operation

Headset operation in Release 7.0 has been enhanced so that MLX headset operation more closely mimics the handset operation in the following ways:

- When a person is on a call using a headset and the headset auto-answer is turned on, the user hears a short ring when another call is coming in. In previous releases, this ring was not provided.
- When a person receives a voice-announced call and handles the call by using a headset and turning off the speakerphone, the associated LEDs (the DSS button and the inside Auto Dial button) for that extension at other telephones are lit. In previous releases, the LEDs for that extension did not light at the other telephones.
- When a reliable disconnect occurs on a headset-handled call, the associated LEDs (the DSS button and the inside Auto Dial button) for that extension at other telephones are turned off. In previous releases, the LEDs for that extension remained lit at the other telephones unless the user pressed the Headset Hangup button.

Touch-Tone or Rotary Signaling

Beginning in Release 7.0, you can program tip/ring ports to use rotary signaling. You can program any tip/ring port on an individual basis (including ports on the 412 LS-ID-ETR and 016 ETR modules that are programmed for tip/ring operation). The factory setting is that rotary signaling is disabled.

Whenever the system receives a rotary digit on a port, it determines if the port is programmed as rotary-enabled. If the port is rotary-enabled, the system processes the digit. If the port is not rotary-enabled, the digit is rejected. Touch-tone digits are always accepted by the port, regardless if it is rotary-enabled or not.

Abandoned Call Information Reported to MERLIN LEGEND Reporter

For abandoned calls, you are now able to identify the queue or the agent where the call was abandoned. The MERLIN LEGEND Release 7.0 software has been modified so that either of the following occurs:

- If the caller hangs up while the call is in queue, the Auto Login/Logout Group ID is entered into the Station Message Detail Recording (SMDR) record.
- If the caller hangs up while the call is ringing at a group member's extension, that group member's extension number is entered into the SMDR record.

Prior Releases: Features and Enhancements

Release 6.1 Enhancements (August 1998)

Release 6.1 includes all Release 6.0 functionality plus the enhancements listed below.

Private Networking

Release 6.1 enhances the functioning of the networked MERLIN LEGEND Communications System in a number of ways:

- Centralized Voice Messaging
- Group Calling Enhancements
- Transfer Redirect
- Direct Station Selector
- Call Forwarding
- SMDR
- Decrease in Call Set-Up Time
- PRI Switch Type Test

Centralized Voice Messaging

One or more MERLIN LEGEND Systems (Release 6.1 or later) can share the voice messaging system (VMS) of another MERLIN LEGEND System, provided the systems are directly connected to the system with the VMS. In this configuration, the system containing the VMS is known as the *hub*. This sharing of the VMS is called *Centralized Voice Messaging*. Centralized Voice Messaging

includes the functions of voice mail, Automated Attendant, and fax messaging. See the *Network Reference* for detailed information about Centralized Voice Messaging.

Centralized Voice Messaging offers the following benefits:

- Private-networked MERLIN LEGEND Systems do not need a local VMS. Having systems use a centralized VMS instead of separate VMSs is more economical.
- Users who travel between sites can dial the same digits anywhere in the private network to access the voice messaging system. For example, a salesperson headquartered in Cincinnati can dial the same four digits at the company's Los Angeles office to retrieve voice messages.
- Productivity is enhanced because messages can be forwarded and broadcast to all personnel within the private network.
- Calling groups on networked systems can send overflow coverage to a shared VMS, so that an incoming caller can leave a message instead of waiting in a queue.
- The VMS can light the Message Waiting lights on multiple MERLIN LEGEND Systems in a private network. This greater efficiency saves time because a user only has to look at his or her telephone to determine if he or she has a message.

Group Calling Enhancements

A calling group can have a *single* non-local member that is defined by the Uniform Dial Plan and exists on another MERLIN LEGEND Communications System connected by a tandem trunk to the local system. If a calling group contains a non-local member, the non-local member must be the *only* member in the calling group. See the *Network Reference* for details.

A calling group containing a single non-local member can be used for the same purposes as a calling group containing local extensions, including:

- **Night Service.** Night Service coverage can be provided across a private network to a centralized Automated Attendant, a non-local calling group, a QCC queue, a DLC, or any individual extension on the remote system, such as a night bell.
- **Group Coverage.** Group Coverage can be provided across a private network to a VMS, a non-local calling group, a QCC queue, a DLC, or any individual extension on the remote system.
- **Calling Group Overflow Coverage.** Calling group overflow coverage can be provided by a centralized VMS, a non-local calling group, a QCC queue, a DLC, or any individual extension on the remote system.
- **Calls Directed to Another System.** Lines connected to remote systems can be answered by any extension programmed to answer the call, such as a centralized Automated Attendant or a system operator (QCC or DLC).

Transfer Redirect

When an Automated Attendant transfers a call to a non-local extension, the transferring MERLIN LEGEND System monitors the call to ensure that it is answered. If the non-local extension is not available, or the call is not answered within the transfer redirect timeout period (fixed at 32 seconds), the call stops ringing at the non-local destination and is redirected to the extension on the same system as the Automated Attendant that is programmed to receive redirected calls. This redirect extension can be a QCC queue, a calling group, or an individual extension.

Direct Station Selector

Now users can press a Direct Station Selector (DSS) button for a non-local extension to make or transfer calls to that extension. No busy indication, however, is displayed by the DSS for non-local extensions.

Call Forwarding

The Forward feature now can be used to send calls to non-local extensions across the private network.

SMDR

In addition to SMDR options for non-network calls placed to and from the local system, system managers now can program SMDR to log incoming and outgoing UDP calls, or they can choose to log no UDP calls. The factory setting is to record all UDP calls.

Customers who use a call accounting system may not want to fill the database with calls coming and going across the private network. These customers may choose not to log UDP calls.

Decrease in Call Setup Time

The setup time for a call across a private network has been reduced by programming the number of UDP digits expected.

PRI Switch Type Test

A new maintenance test, the PRI Switch Type Test, has been created to allow Lucent Technologies technicians or authorized dealers to automatically determine if each end of the PRI tandem trunks has been programmed correctly. The test works for directly connected MERLIN LEGEND Systems, not for DEFINITY® systems.

For a PRI tandem trunk to operate correctly between two MERLIN LEGEND Systems, one system must have the PRI Switch Type set to Network, and the other system must have the PRI Switch Type set to PBX. If both ends of the PRI

tandem trunk are programmed the same, problems occur in the communications between the two systems.

Service Observing

Service Observing allows one extension to listen in on (observe) a call at another extension. A typical application of this feature is that of a Customer Service supervisor observing how a Customer Service representative handles calls.

The Service Observing group can listen to anywhere from one extension to all extensions in the system, including other Service Observers. Up to 16 Service Observing groups can be programmed. The Service Observer and the observed extension must be on the same system.

The observer activates Service Observing either by pressing a Service Observing button and then dialing an extension number, or by pressing a DSS or Auto Intercom button. The Service Observer must use an MLX telephone to observe an extension; the telephone at the observed extension can be of any type.

A warning tone that alerts the observer, the observed extension, and the caller that Service Observing is occurring can be set to on or off through System Programming. The factory setting is on.

WinSPM

The System Programming and Maintenance (SPM) software is now available in a Windows format called WinSPM. For R6.1 and later systems, WinSPM provides a graphical user interface (GUI) for those tasks most commonly performed by the system manager. Pictorial representations of system components, such as modules and their vintages and the creation of MLX telephone button labels appear on WinSPM. Supported in Windows 95, Windows NT, and Windows 98, WinSPM is also backwards-compatible with previous DOS versions of SPM and is available on CD-ROM.

Windows NT Driver

The MERLIN LEGEND Windows NT PBX driver is available in R6.1. When coupled with the CentreVU Telephony Services application, the driver provides true server-based Computer Telephony Integration (CTI). The new driver requires a MERLIN LEGEND System of Release 5.0 or later and servers and PCs that support the applications.

Release 6.0 Enhancements (February 1998)

Release 6.0 includes all Release 5.0 functionality, plus the enhancements listed below.

Private Networks

In Hybrid/PBX mode systems only, MERLIN LEGEND Communications Systems can be networked with one another or with DEFINITY Enterprise Communications Server (ECS) and ProLogix™ Communications Systems in private networks. In previous releases, this functionality is available using tie lines, but users handle calls between networked switches as outside calls. In this release, dialing the pool access code is not necessary for a call going from one networked switch to another. Also, delay-start tie trunks or T1 trunks administered as PRI can act as *tandem trunks* to connect networked systems.

Available for Hybrid/PBX mode systems, the private network features of the MERLIN LEGEND Communications System Release 6.0 provide the following advantages for geographically dispersed organizational sites:

- **Intersystem Calling.** In a private network, users on one local system can call extensions on other systems in the network. Release 6.0 can support 2-, 3-, 4-, or 5-digit dial plans. They dial these extensions as inside calls. To implement this function, the system manager programs the extension ranges of remote networked switches to create a non-local dial plan. This programming does not actually affect numbering on the remote system. To correctly set up systems for transparent calling among non-local dial plan extensions, the system manager assigns networking tie and/or PRI tandem trunks to pools. Then he or she programs up to 20 patterns, associated routes, Facility Restriction Levels (FRLs), digit absorption, and digit prepending. This allows ARS-like routing of non-local dial plan calls. In addition, system managers can control whether calling name, calling number, or both are shown at MLX display telephones for incoming calls across PRI tandem trunks.
- **Toll Savings.** Private networked trunks may allow you to realize significant cost savings on long-distance and toll calls by performing tandem switching in the following two ways:
 - Callers on a local system, or individuals dialing in to remote access at a local system, can reach the public switched telephone network (PSTN) via outside trunks connected to other systems in a private network, avoiding toll charges or decreasing the cost of toll calls. No special dialing is required. For example, an organization might have a main office in Boston and a subsidiary office in New Jersey connected by networked private tandem trunks between two systems. A user in the New Jersey office who wishes to make an outside call to the 617 area code (Boston) can do so through a line/trunk connected to the system in Boston. For example, he or she

might dial, 916175551211. The local ARS tables would route this call over the private networked trunks and use the ARS tables of the remote system in Boston to route this call. The system managers at each end of a private network set up ARS and Remote Access features to implement this functionality.

- In addition, local organizations or incoming DID calls use private networked trunks to make intersystem calls between networked systems, which may be geographically distant from one another, also resulting in toll savings.
- **Service Cost Savings.** In addition to toll call savings, there are two ways that organizations can save on service costs incurred from telecommunications providers that provide public switched telephone network access:
 - You order a point to point T1 facility from a service provider, then use system programming to set it up for PRI signalling. As necessary, a service provider can provide amplification on the T1 facility, but does not supply switching services.
 - You can tailor your use of PRI B-channels with drop-and-insert equipment that allows fractional use of B-channels for dedicated data/video communications between systems at speeds greater than 64 kbps per channel or 128 kbps for 2B data, while keeping the remaining B-channels available for PRI voice traffic. The PRI D-channel must remain active.
 - You can tailor use of T1 channels to support both T1-emulated tandem tie service and T1 Switched 56 service for data communications at 56 kbps per channel, allowing 2B data transfers at 112 kbps. You can also use drop-and-insert equipment to provide fractional T1 use.
- **Voice Mail and Auto Attendant.** Networked systems (prior to Release 6.1) should have their own local voice mail and/or auto attendant applications as well as their own external alerts and Music-On-Hold sources. A single Auto Attendant, however, can transfer calls throughout the network. It can answer only those calls that arrive on the PSTN facilities of the system where it is connected.

Although many features are available using tie trunks for network connectivity, PRI tandem trunks provide greatly enhanced features and faster call setup. For this reason, PRI is recommended over tie functionality in private networks.

Group Calling Enhancements

Release 6.0 and later systems include Group Calling features that enhance group calling operations.

Queue Control

The system manager can control the maximum number of calls allowed in the primary calling group queue for calls that arrive on certain facilities often assigned to calling groups. When the number of the calls in queue reaches the programmed maximum, subsequent callers receive a busy signal.

Queue control applies to calls received on the following types of facilities:

- Direct Inward Dialing (DID)
- PRI facilities programmed for dial-plan routing
- All calls transferred from a voice messaging interface (VMI) port
- Dial-in Tie

Queue control also applies to internal calls to a calling group and calls to a calling group through the Queued Call Console (QCC).

Internal calls that dial #0 or #800 and are directed to a calling group administered as Position-Busy Backup are eligible for queue control. Calls that come in on a trunk assigned to the QCC are not eligible for queue control if the call is directed to a calling group designated as Position-Busy Backup.

Remote-access calls to a calling group, coverage calls directed to a calling group, calls directed to a calling group through QCC Position-Busy Backup, and all other outside calls are not eligible for queue control.

Prompt-Based Overflow

System managers can activate the Prompt-Based Overflow option. This option allows callers waiting in queue and listening to a delay announcement to press the # key in order to reach the overflow receiver for the group, which may be the QCC queue or another calling group (including a calling group assigned for a voice mail system).

All three overflow distribution options—based on the number of calls, the time a caller has waited, and according to the caller's prompt—may be used at one time. In this case, time-based and number-of-calls based options take precedence over overflow distribution based on the caller's prompt.

When prompt-based overflow distribution is used, an extra TTR must be provided for each delay announcement device assigned to the associated calling group. The delay announcement informs the caller of the # key option to exit the queue and leave rather than waiting for an agent. If no TTR is available when a calling group call arrives, the call is not sent to a delay announcement extension.

Centrex Transfer via Remote Call Forwarding

Centrex Transfer via Remote Call Forwarding can be used in all system modes of operation to send outside calls to a remote telephone number or another Centrex station. In this context, the term *outside calls* refers to calls from outside the communications system, which may originate at extensions in the Centrex system that are not connected to the local MERLIN LEGEND Communications System.

An outside call that uses this feature is defined as a call that arrives on an analog Centrex loop-start line at the MERLIN LEGEND Communications System. It may arrive directly or be transferred without consultation or without transfer supervision (in the case of an automated attendant). The forwarding call to the outside number is made on the same line/trunk on which the call arrived, conserving system facilities. The following considerations and rules apply:

- Only outside Centrex calls are forwarded using this feature.
- The system must be equipped with analog loop-start Centrex lines and *all* loop-start lines in the system must be Centrex facilities. Loop-start lines do not have to provide reliable disconnect for use by the Centrex Transfer via the Remote Call Forwarding feature.
- To transfer calls outside the Centrex system, the organization must subscribe to a Centrex trunk-to-trunk transfer feature.

Activating Centrex Transfer via Remote Call Forwarding is just like activating regular Remote Call Forwarding and requires that Remote Call Forwarding be enabled for the extension. However, the user dials * instead of a dial-out code, and a Pause character may be required after the *. The Centrex service provider determines whether the Pause is needed.

Pause cannot be originated from a single-line telephone or a remote access user. A multiline telephone user in the local system must enter an authorization code to activate the feature.

A remote access user may activate the feature without using an authorization code. Barrier code requirements, however, do apply.

Authorization Codes and Remote Call Forwarding

In Release 6.0 and later Key or Hybrid/PBX mode systems, forwarding features (including Centrex Transfer via Remote Call Forwarding, but excluding Follow Me) can be activated or deactivated at a multiline telephone by entering the authorization code for the extension from which calls are to be forwarded. The user enters the authorization code, then activates or deactivates the forwarding feature in the normal fashion. This is especially useful for a single-line telephone user who must include a Pause character in a Centrex Transfer via Remote Call Forwarding dialing sequence, because the character cannot be dialed at a single-line telephone. It is also useful when activating Call Forwarding or Remote Call

Forwarding at phantom stations or via remote access (for example, from another switch in the network). No other features can be used by entering an authorization code in this fashion.

Release 5.0 Enhancements **(June 1997)**

Release 5.0 includes all Release 4.2 functionality, plus the enhancements listed below.

Computer Telephony Integration (CTI)

Beginning with Release 5.0, a PassageWay[®] Telephony Services CTI link from the MERLIN LEGEND Communications System to a LAN server running Novell[®] NetWare[®] software allows Lucent Technologies-certified telephony applications to control and monitor MLX and analog multiline telephone (BIS only) operations. The physical connection for the CTI link is an MLX port on a 008 MLX or 408 MLX module on the MERLIN LEGEND Communications System control unit and an ISDN link interface card plugged into the customer's server. The feature is available for Hybrid/PBX mode systems only.



NOTES:

- The NetWare server software version must be 3.12, 4.1, or 4.11.

- The 008 MLX and 408 MLX modules must have a firmware vintage other than 29. If the module has firmware 29, programming a CTI link on the module is prevented. An earlier or later vintage firmware is supported.

Basic Call Control

A CTI link application on a user's computer can assume basic call control of the user's analog multiline or MLX telephone's SA buttons. Basic call control includes:

- Answering calls arriving on an SA button.
- Making calls from an SA button.
- Hanging up calls.
- Holding and retrieving a call on hold at the user's extension.



NOTE:

Transfer and three-way conference, when handled through a CTI link application, provide the original caller's calling number information or other information to the transfer receiver or new conference participant, if the user has screen-pop capability.

Screen Pop

Screen pop occurs when the calling number, called number, or other user-defined identifier (such as an account code that a voice-response unit prompts the caller to dial) is used to display a screen associated with the far-end party. For example, Caller ID services can be used to support screen pop on a system that includes a CTI link; using the calling party number as a database key code, information about a caller automatically appears on the user's computer screen when the call arrives at the extension. Depending on the application, screen pop may be available for calls that arrive on line buttons other than SA buttons and/or calls that are answered manually at the telephone rather than by the application.

Screen pop can occur on incoming calls from the following sources:

- Calling group distribution.
- ISDN PRI Routing by Dial Plan.
- An extension on the MERLIN LEGEND Communications System.
- Remote access.



NOTE:

In the case of remote access calls, the only information that the application can collect about the caller is the remote telephone number.

- A transfer of a call that was answered by a voice response unit.
- A transfer, redirection, or conference of a call that was answered at a Direct-Line Console (DLC) or at a Queued Call Console (QCC).



NOTES:

- DLCs may use CTI applications. If they do, they perform the same way as other extensions. A DLC assigned to use a CTI link application is a monitored DLC. When a DLC is used as a regular operator console and is not using a CTI link extension, it is non-monitored.
- Calls to a QCC or a DLC not using a CTI application do not initiate screen pop at the operator position. However, when an operator directs a call to an extension using a CTI application, caller information does initiate screen pop. If the DLC is non-monitored, screen pops can occur after the DLC releases the call.
- Calls transferred from Cover buttons on non-monitored DLCs do not initiate screen pop at the destination extension.

HotLine Feature

The Release 5.0 HotLine feature is designed for retail sales, catalogue sales, and other types of businesses and organizations, and is available in all three modes of system operation. It allows a system manager to program a single-line telephone extension connected to an 008 OPT, 012, or 016 module as a HotLine. When a user lifts the handset at the HotLine extension, the telephone automatically dials the inside extension or outside telephone number programmed as the first Personal Speed Dial number (code #01) for the extension. The system does not permit calls to be transferred, put on hold, or conferenced. (A user can press the telephone's Hold button, if it has one, to put a call on local hold, but the call cannot be redirected in any way. Switchhook flashes are ignored.)

Personal Speed Dial codes can be programmed from the extension prior to HotLine assignment (a system programming function). Alternatively, a Personal Speed Dial code can be programmed from the single-line telephone after HotLine operation is assigned. However, because of security considerations, this is a one-time opportunity. Once the Personal Speed Dial number is programmed, any changes to it or any other extension programming must be performed using centralized telephone programming.

Any type of inside or outside line that is normally available to a single-line telephone can be assigned to a HotLine extension. Generally, the HotLine telephone does not receive calls, and its lines should be set to No Ring.



SECURITY ALERT:

If a HotLine extension accesses a loop-start line, that line should provide reliable disconnect and be programmed for reliable disconnect. Otherwise, a user at the extension may be able to stay on the line after a call is completed and then make a toll call.

Group Calling Enhancements

Release 5.0 and later systems include Group Calling features that enhance group calling operations.

Most Idle Hunt Type

In addition to the Circular (factory setting) and Linear hunt types supported in earlier releases, a third hunt type distributes calling group calls in an order based on which agent has waited the longest since transferring or hanging up on an incoming calling group call. For some applications, this hunt type is more efficient than the circular type because it takes into account the varying duration of calls. The system distributes calls based on when an agent last completed a call, not on when he or she last received one. This hunting method ignores non-calling group calls. For example, if an agent transfers a call that arrived on a line not assigned to the calling group, the calling group member's most-idle status is unaffected.

Delay Announcement Devices

The system manager can designate as many as ten primary delay announcement devices per group, rather than the single device for each group that is available in Release 4.2 and earlier systems. Furthermore, an additional secondary delay announcement device can be specified, for a total of ten primary device extensions and one secondary device extension per group.

A primary delay announcement device operates in the same fashion as a single delay announcement device, playing once, as soon as it is available, for the caller who has waited the longest for a calling group agent and has not heard a primary delay announcement. If a secondary announcement device is used, it can use the factory setting, which plays the announcement once, or it can be set to repeat the announcement after a certain amount of time. The system manager programs the time (0–900 seconds) between announcements. This setting controls both the interval between primary and secondary announcements and the interval between repetitions of the secondary announcement, if it is set to repeat. (See “Calling Group Options” in Chapter 4 of *System Planning* for guidelines on setting the delay.)

The primary and secondary announcement options, when used together, allow an initial message to play for callers, followed by a repeating announcement that, for example, urges callers to stay on the line and wait for a calling group member.

Two or more groups may share an announcement device.

A primary delay announcement device can be programmed as a secondary delay announcement device.

Enhanced Calls-in-Queue Alarm Thresholds

Three Calls-in-Queue Alarm thresholds can be set to more clearly indicate the real-time status of the calls waiting in the queue according to the behavior of programmed Calls-in-Queue Alarm buttons. In earlier releases, only one Calls-in-Queue Alarm Threshold setting is available to activate the LEDs at programmed Calls-in-Queue Alarm buttons for a calling group.

Using all three levels, the system manager sets Threshold 3 to the highest value, Threshold 2 to a middle value, and Threshold 1 to the lowest value. A Calls-in-Queue Alarm button indicates the severity of the alarm conditions in the following ways:

- If the number of waiting calls is less than the value programmed for Threshold 1 or drops below that level, the LED is unlit.
- If the number of waiting calls is greater than or equal to the Threshold 1 value but less than the Threshold 2 value, the LED flashes.
- If the number of waiting calls is greater than or equal to the Threshold 2 value but less than the value for Threshold 3, the LED winks.
- If the number of waiting calls is greater than or equal to the highest value, Threshold 3, the LED lights steadily.



NOTE:

A Direct Station Selector (DSS) button that is used as a Calls-in-Queue Alarm button can only indicate two threshold levels, either by flashing or by lighting steadily. If a calling group must use this type of Calls-in-Queue Alarm button, only two threshold levels should be programmed.

If all three thresholds are set to the same value, the result is one threshold only with LED state either off or on (steady). If two values are the same, then the result is two alarm levels (flash, steady). The factory setting is one call for all three thresholds, with LED states of off and steady.

An external alert signals only when the number of calls in the queue meets or exceeds the programmed Threshold 3 value.

MLX-5 and MLX-5D Telephones

The MLX-5 nondisplay and MLX-5D display telephones are compatible with all system releases. The display telephone includes a 2-line by 24-character display, and both telephones come with five line buttons. In systems prior to Release 5.0, the MLX-5 and MLX-5D telephones are treated as MLX-10 and MLX-10D telephones, respectively. As of Release 5.0, the system recognizes the MLX-5 and MLX-5D telephones as 5-button telephones.

If these telephones are connected to communications system releases prior to 5.0, they are recognized by the communications system as 10-button telephones.

Release 4.2 Enhancements **(June 1997)**

Release 4.2 includes all Release 4.1 functionality, plus the enhancements listed below. There are no hardware changes for Release 4.2.

Additional Network Switch and Services Options **for ISDN Primary Rate Interface (PRI)**

Release 4.2 of the system supports connectivity to MCI[®] or local exchange carrier (LEC) PRI services and to the following central office switch types (in addition to the 4ESS[™] and 5ESS[®] switch types that carry AT&T Switched Network services):

- NORTEL[®] DMS[™]-100 BCS 36 for local exchange carrier services.
- NORTEL DMS-250 generic MCI07, serving the MCI network.
- Digital Switch Corporation DEX600E generic 500-39.30, serving the MCI network.

Beginning with Release 4.2, the following MCI PRI and PRI local exchange carrier (LEC) services (along with AT&T Switched Network services) can be provided to users of the MERLIN LEGEND Communications System:

- MCI Toll Services for DMS-250 or DEX600E switch type:
 - MCI Prism[®] service for domestic outgoing long-distance and international voice calls; for domestic outgoing 56-kbps restricted, 64-kbps unrestricted, and 64-kbps restricted circuit-switched data calls.
 - MCI VNet[®] service for incoming and outgoing domestic and voice calls; for 56-kbps restricted, 64-kbps restricted, and 64-kbps unrestricted circuit-switched data calls.
 - MCI 800 for domestic, toll-free incoming voice calls.
 - MCI 900 service numbers.
- LEC services for DMS-100 switch types:
 - DMS Virtual Private Network service for calls between the MERLIN LEGEND Communications System and another communications system (such as another MERLIN LEGEND Communications System).
 - DMS INWATS (Inward Wide Area Telephone Service) for domestic toll-free incoming voice calls.

- DMS OUTWATS (Outward Wide Area Telephone Service) for domestic outgoing long-distance voice calls.
- DMS FX (foreign exchange) to provide local call rating for calls from the local exchange to the area serviced by the foreign exchange.
- DMS tie trunk service to provide private exchange call rating for calls placed on a dedicated central office facility between the MERLIN LEGEND Communications System and another communications system (such as another MERLIN LEGEND Communications System).

Improvements to Station Message Detail Recording (SMDR) and Support for MERLIN LEGEND Reporter Application

The SMDR feature is enhanced to provide more details about calling group agent activities and to help system managers assess the effectiveness of call centers in terms of both agent performance and the adequacy of facilities to handle inbound calls. These improvements apply to calling groups that are programmed as Auto Login or Auto Logout type. The SMDR and MERLIN LEGEND Reporter features listed are administrable:

- **TALK Field.** For Auto Login and Auto Logout calling groups, the TALK field records the amount of time a calling group agent spends on a call.
- **DUR. (DURATION) Field.** For Auto Login and Auto Logout calling groups, call timing begins when a call arrives at the MERLIN LEGEND Communications System and not after a preset number of seconds. Call timing ends when the call is disconnected; either the caller or the agent hangs up. This allows the system manager to determine how long a caller waited for an agent's attention.
- **Coding of Calls on Reports.** An asterisk (*) appears in the call record when:
 - A call is not answered by an Auto Login or Auto Logout calling group agent and is abandoned while waiting for an agent.
 - The call is answered by someone not a member of an Auto Login or Auto Logout calling group.

An exclamation point (!) signals that an Auto Login or Auto Logout agent handled a call that was answered by someone who was not a member of that Auto Login or Auto Logout with Overflow group. An ampersand (&) in the call record indicates that the group's overflow receiver answered the call.

MERLIN LEGEND Reporter

MERLIN LEGEND Reporter provides basic call accounting system reports for all incoming calls to Auto Login or Auto Logout type calling groups. MERLIN LEGEND Reporter assists in determining the effectiveness of calling group agents, assessing the level of service provided to callers, and ascertaining whether adequate incoming telephone lines and agents are available to handle peak-call load. The SMDR Talk Time option sets up special call records used by MERLIN LEGEND Reporter. The default is off, in which case the Release 4.0 SMDR reports are available. If the option is set to on, the following new reports are provided:

- Organization Detail Report
- Organization Summary and Trends Report
- Selection Detail Report
- Account Code Report
- Traffic Report
- Extension Summary Report
- Data Report
- Talk and Queue Time Distribution Report
- Time of Day Report
- ICLID Call Distribution Report
- Facility Grade-of-Service Report

Maintenance Enhancements

Change to Permanent Error Alarm

Beginning with Release 4.2, the most recent permanent error alarm is not shown on the System Error Log menu screen but is available as an option from that screen. For details, refer to the maintenance section of the technician guide, *Installation, Programming, and Maintenance*.

Enhanced Extension Information Report

Beginning with Release 4.2, the Extension Information Report includes the Extension Status and supervisory mode of each extension.

Release 4.1 Enhancements **(June 1997)**

Release 4.1 includes all Release 4.0 functionality, plus the enhancements listed below. There are no hardware changes in Release 4.1.

Coverage Timers Programmed for Individual Extensions

Beginning with Release 4.1, coverage timers, which control the duration of the delay before calls are sent to each level of coverage, are changed as follows:

- The Group Coverage Ring Delay (1–9 rings) is programmed on individual extensions and replaces the Coverage Delay Interval programmed systemwide in previous releases.
- The Primary Cover Ring Delay (1–6 rings) and Secondary Cover Ring Delay (1–6 rings), programmed on individual extensions, replace the Delay Ring Interval programmed systemwide in previous releases.

These enhancements allow the system manager to customize coverage call delivery to match individual extensions' call-handling requirements.

Night Service with Coverage Control

Beginning with Release 4.1, a system manager can enable the Night Service Coverage Control option to automatically control the status of telephones programmed with Coverage VMS (voice messaging system) Off buttons, according to Night Service status.

When Coverage Control is enabled and the MERLIN LEGEND Communications System is put into Night Service, all programmed Coverage VMS Off buttons are automatically turned off (LED is unlit) and all eligible outside calls are sent to the assigned voice messaging system calling group with normal ringing delay. When Night Service is deactivated during the day, all programmed Coverage VMS Off buttons are automatically turned on (LED is lit) and voice mail coverage is disabled for outside calls.

Users can override the Coverage VMS Off button status at any time by pressing the programmed Coverage VMS Off button to turn the LED on or off.

Night Service Group Line Assignment

Beginning with Release 4.1, a system manager can assign lines to Night Service groups to control handling of after-hours calls received on individual lines. This capability replaces the automatic assignment to Night Service groups of only those lines that ring on the Night Service operator console. An outside line must be assigned to a Night Service group to receive Night Service treatment.

With this enhancement, Night Service can be activated and deactivated on lines that do not appear on operator consoles (for example, personal lines), and lines appearing at operator positions can be excluded from Night Service.

Forward on Busy

Beginning with Release 4.1, the Forward, Follow Me, and Remote Call Forward features are enhanced to remove the requirement that a call be ringing at an extension before it can be forwarded. With the Forward on Busy enhancement, a call to an extension with no available SA or ICOM buttons is forwarded immediately to the programmed destination, preventing the caller from hearing a busy signal from the intended call recipient's extension.

Maintenance Testing for BRI Facilities that Are Part of Multiline Hunt Groups (MLHGs)

Beginning with Release 4.1, the NI-1 BRI (National Integrated Services Digital Network-1 Basic Rate Interface) Provisioning Test Tool is enhanced to include testing for BRI facilities that are part of Multiline Hunt Groups (MLHGs).

The NI-1 BRI Provisioning Test Tool is used by Lucent Technologies maintenance personnel on MERLIN LEGEND Communications Systems that include an 800 NI-BRI module. Technicians use the tool during system installation and maintenance to test the functionality of the BRI lines and to report analyzed results.

Release 4.0 Enhancements **(March 1996)**

Release 4.0 includes all Release 3.1 functionality, plus the enhancements listed below.

Support for Up to 200 Extensions

An expanded dial plan supports up to 200 tip/ring devices.

Support for National ISDN BRI Service

This service (Hybrid/PBX and Key modes) provides an alternative to loop-start and ground-start lines/trunks for voice and digital data connectivity to the central office. Each of the two B-channels (*bearer channels*) on a BRI line can carry one voice and one data call at any given time. The data speeds on a B-channel are up to 28.8 kbps for analog data and up to 64 kbps for digital data, which is necessary for videoconferencing and other high-speed applications. Release 4.0 supports the ISDN Ordering Code (IOC) Package "S" (basic call handling) service configuration and Multiline Hunt service configuration on designated central office switches.

New Control Unit Modules

Release 4.0 supports a new NI-BRI line/trunk module and a higher-capacity tip/ring module.

800 NI-BRI Module

This new module connects NI-BRI trunks to the MERLIN LEGEND System for voice, high-speed data, and video transmission.

016 Tip/Ring Module

This new module supports a 200-extension dial plan by providing 16 ports for tip/ring devices. Applications that use a tip/ring interface can connect to this board. All 16 ports can ring simultaneously. Four touch-tone receivers (TTRs) are included on the module as well. The module's ringing frequency (default 20 Hz) can be changed, through programming, to 25 Hz for those locations that require it.

Downloadable Firmware for the 016 (T/R) and NI-BRI Modules

The Personal Computer Memory Card International Association (PCMCIA) technology, introduced in Release 3.0, continues to support these two modules for installation and upgrade in Release 4.0. A Release 3.0 or later processor is required for PCMCIA technology.

Support for 2B Data Applications

A Lucent Technologies-certified group and desktop video application can use two B-channels to make video/data calls when connected to a single MLX extension jack programmed for 2B data. The 2B data devices must be equipped with ISDN-BRI interfaces. NI-1 BRI, PRI, or T1 Switched 56 facilities support 2B data communications at 112 kbps (using two 56-kbps channels) or 128 kbps (using two 64-kbps B-channels). This feature is available for Hybrid/PBX and Key modes only.

Support for T1 Switched 56 Digital Data Transmission

For Hybrid/PBX and Key mode systems, Release 4.0 expands support of T1 functionality by providing access to digital data over the public switched 56-kbps network, as well as to digital data tie-trunk services. Users who have T1 facilities for voice services can now use them for video or data calls at rates of 56 kbps per channel (112 kbps for video calls using 2B data). The Release 4.0 offering also includes point-to-point connectivity over T1 tie trunks, allowing customers to connect two MERLIN LEGEND Communications Systems or a MERLIN LEGEND Communications System with a Lucent Technologies DEFINITY G1.1 Communications System or DEFINITY Enterprise Communications Server. The two communications systems can be co-located or can be at different sites.

Forwarding Delay Option

Each user can program a Forwarding Delay setting for the Forward, Remote Call Forwarding, or Follow Me features. The forwarding delay is the number of times that a call rings at the forwarding extension before the call is sent to the receiver. The delay period gives the original call recipient time to answer or to screen calls by checking the displayed calling number (if available). The delay can be set from 0 to 9 rings. The factory setting for the forwarding delay is 0 rings (no delay).

Voice Announce on Queued Call Console

The system manager can enable the fifth Call button on a QCC console (Hybrid/PBX mode only) to announce a call on another user's speakerphone (providing the destination telephone has a voice announce-capable SA button available). A QCC cannot receive voice-announced calls; they are received as ringing calls. The factory-set status for the fifth Call button is voice announce disabled.

Time-Based Option for Overflow on Calling Group

Release 4.0 has added a *time* limit for calls in queue in addition to the previous *number of calls* limit. If the Overflow Threshold Time option is set to a valid number between 1 and 900 seconds, calls that remain in the calling group queue for the set time are sent to the overflow receiver. If the overflow threshold time is set to 0, overflow by time is turned off. The factory-set time limit is 0 seconds (off).

Single-Line Telephone Enhancements

The following changes enhance the performance of single-line telephones:

- **Disable Transfer.** Through centralized telephone programming, the system manager can disable transfer by removing all but one SA or ICOM button from the extension.
- **No Transfer Return.** When a handset bounces in its cradle, the system interprets this as a switchhook flash and attempts to transfer a call. When the transfer attempt period expires, the user's telephone rings. Release 4.0 eliminates this unintended ringing by disconnecting the call in situations where a switchhook flash is followed by an on-hook state and a dial tone is present.
- **Forward Disconnect.** All ports on 008 OPT, 012, and 016 modules now send forward disconnect to all devices connected to them when forward disconnect is received from the central office. This enhancement prevents the trunk/line from being kept active when one end disconnects from the call. If an answering machine is connected to the port, it does not record silence, busy tones, or other useless messages. This operation is not programmable.

Seven-Digit Password for SPM

Release 4.0 has increased system security by requiring a 7-digit password for system managers or technicians who use System Programming and Maintenance (SPM) to perform programming or the Trunk Test procedure. This password is for use in addition to a remote access barrier code.

Release 3.1 Enhancements (March 1996)

Release 3.1 includes all Release 3.0 functionality, plus the enhancements listed below.

Call Restriction Checking for Star Codes

Beginning with Release 3.1, a system manager can add star (*) codes to Allowed and Disallowed Lists to help prevent toll fraud. Star codes, typically dialed before an outgoing call, enable telephone users to obtain special services provided by the central office. For example, in many areas, a telephone user can dial *67 before a telephone number to disable central office-supplied caller identification at the receiving party's telephone. You must contract with your telephone service provider to have these codes activated.

When users dial star codes, the system's calling restrictions determine whether the codes are allowed. If they are allowed, the system's calling restrictions are reset, and the remaining digits that the users dial are checked against the calling restrictions.

Trunk-to-Trunk Transfer Set for Each Extension

This enhancement to the Transfer feature enables the system manager to allow or disallow trunk-to-trunk transfer on a per-extension basis. In Release 3.1 and later systems, the default setting for all extensions is restricted.

Programmable Second Dial Tone Timer

The system manager can assign a second dial tone timer to lines/trunks, in order to help prevent toll fraud (for example, when star codes are used). After receiving certain digits dialed by a user, the central office may provide a second dial tone, prompting the user to enter more digits. If this second dial tone is delayed, and the user dials digits before the central office provides the second dial tone, there is a risk of toll fraud or misrouting the call. The second dial tone timer enables the system manager to make sure that the central office is ready to receive more digits from the caller.

Security Enhancements

The sections below outline security measures that are implemented in Release 3.1 and later systems.

Disallowed List Including Numbers Often Associated with Toll Fraud

A factory-set Disallowed List 7 contains default entries, which are numbers frequently associated with toll fraud. By default, Disallowed List 7 is automatically assigned to both generic and integrated voice messaging interface (VMI) ports used by voice messaging systems. The system manager can manually assign this list to other extensions.

Default Pool Dial-Out Code Restriction for All Extensions

The default setting for the pool dial-out code restriction (Hybrid/PBX mode only) is restricted. No extension or remote access user with a barrier code has access to pools until the restriction is removed by the system manager.

Default Outward Restrictions for VMI Ports

Ports assigned for use by voice messaging systems (generic or integrated VMI ports) are now assigned outward restrictions by default. If a voice messaging system must be allowed to call out (for example, to send calls to a user's home office), the system manager must remove these restrictions.



SECURITY ALERT:

Before removing restrictions, it is strongly recommended that you read Appendix A, "Customer Support Information," in System Programming.

Default Facility Restriction Level (FRL) for VMI Ports

The default Automatic Route Selection (ARS) FRL for VMI ports is 0, restricting all outcalling.

Default for the Default Local Table

The default Automatic Route Selection (Hybrid/PBX mode only) FRL has changed to 2 for the Default Local table. System managers can easily change an extension's default FRL of 3 to 2 or lower to restrict calling. No adjustment to the route FRL is required.

New Maintenance Procedure for Testing Outgoing Trunks

Technicians must enter a password in order to perform trunk tests.



SECURITY ALERT:

The enhancements in Release 3.1 help increase the security of the MERLIN LEGEND System. To fully utilize these security enhancements, be sure to read and understand the information in these upgrade notes and in the relevant system guides.

Release 3.0 Enhancements (August 1994)

Release 3.0 includes all Release 2.1 functionality plus the enhancements listed below.

Equipment

New hardware includes a variety of components. Additional details are included elsewhere in this book.

- CPU modifications include:
 - A processor running at 16 MHz with a 32-bit wide data bus.
 - 1.5 MB of non-volatile (battery-backed) RAM.
 - 4.0 MB of Flash ROM.
 - PCMCIA memory card interface.
 - A full-duplex 1200/2400 bps modem.
 - Error/Status code display for maintenance support.
- An 800 GS/LS-ID line/trunk module delivers the calling party's telephone number to the customer premises (MLX display telephones only) if the service is subscribed to by the customer and if it is supported by the caller's telephone company.
- Support for:
 - MDC 9000 (six-line, cordless).
 - MDW 9000 (six-line, cordless, wireless).
 - 8101 (single-line telephone, desk or wall-mount, data/fax jack, selectable positive disconnect).

- 2500YMGL and 2500 MMGL (single-line desk telephones, selectable positive disconnect).
 - Picasso™ Still-Image telephone (for interactive display of still images).
 - Videophone 2500 single-line telephone with interactive video display
- Pre-fabricated and pre-drilled backboard.

Installation, Upgrade Administration, and Maintenance

These are the new MERLIN LEGEND Communications System capabilities:

- SPM (Release 3.18) conversion of translations from Release 1.0, 1.1, 2.0, and 2.1 to 3.0.
- Remote operation at 1200/2400bps.
- Advice and feedback administration screens for new Release 3.0 functionality.
- PCMCIA Memory Card Interface (a Release 3.0 processor board required) allowing:
 - System software installation.
 - System software upgrade.
 - 800 GS/LS-ID port module firmware upgrade.
 - Integrated backup and restore of translations.
 - Automatic and manual options for backup and restore are available on the system. Automatic backup can be scheduled weekly or daily to fit the customer's needs.
- Inter-digit dialing timer values are programmable.
- Inspection of Lines/Trunks displays only those lines and trunks configured on system rather than all 80 facilities.
- Extensions and facilities in Maintenance Busy (both manual and automatic) can be identified by the maintenance monitor.

User Features

Security

The Remote Access feature allows people at remote locations to enter the system by dialing the number of a line or trunk designated for remote access. The system can be programmed to require the remote user to dial a barrier code (a type of password) after reaching the system. In earlier versions, the systemwide barrier

code length is fixed at four digits. Release 3.0 allows a systemwide barrier code length ranging from a minimum of four digits to a maximum of 11 digits, with a factory setting of seven digits. SMDR records are enhanced to provide information for remote access calls. If the remote access call is received on a facility providing Caller ID information (see below), the SMDR report can help trace the call.

Caller ID

Caller information (telephone number) is furnished to MLX display telephones by an 800 GS/LS-ID module using the LS (loop-start) option. This allows customers to screen calls before answering the telephone, as well as providing calling party information for use with various applications. This function is available only when the customer subscribes to caller identification service from the telephone company, if the telephone company supports that service.

Shared System Access (SSA)

A telephone may have up to 27 Shared SA buttons to expand extension coverage.

Authorization Codes

The Authorization Code feature allows you to make calls using your calling privileges when you are dialing from an extension other than your own. When you enter your authorization code (ranging from 2 to 11 characters and unique across the system), the privileges and restrictions assigned to your home extension override the current restrictions at the host extension. This includes toll restriction, outward restriction, Facility Restriction Level (FRL), Allowed Lists, Disallowed Lists, Night Service Exclusion List, and Dial Access to Pools. All other functions on the telephone are those of the local telephone, not the home extension.

Authorization codes can also be used for the purpose of call accounting through the SMDR printout. The SMDR account code field can hold either the authorization code extension number or the authorization code itself.

Direct Voice Mail

If your company has voice mail, this feature allows you to dial a co-worker's voice mailbox directly without ringing that person's extension. Direct Voice Mail is especially useful for transferring calls when a co-worker is not available.

Additional Features

The status of Leave Word Calling (LWC) and Privacy are retained across cold starts.

Caller ID (CLASSSM ICLID and PRI) are available on primary coverage and return from transfer.

Additional Application Packages, Adjuncts, and Adapter Enhancements

PassageWay Direct Connection Solution

PassageWay Direct Connection Solution (Release 2.0) is a computer telephony integrated product that links a desktop Microsoft[®] Windows[®]-based PC to the MERLIN LEGEND Communication System's MLX-10DP, MLX-20L, or MLX-28D telephone. The Windows applications are: AT&T Call (autodial/contact manager), AT&T Buzz (screen-pop applications), AT&T Set (extension programming interface), and Log Viewer (call log application). PassageWay Direct Connection Solution (Release 2.0) is the version supported on MERLIN LEGEND Communications System Release 3.0.

PagePal[™]

PagePal connects several paging systems to the MERLIN LEGEND Communications System. No other system adapter is necessary for loudspeaker paging.

Fax Attendant 2.1.1

Fax Attendant Release 2.1.1, which co-resides with AUDIX Voice Power on the IS III Release 1.2 platform, provides the same functionality as earlier versions, plus the following enhancements:

- **Personal Fax Messaging.** Inbound faxes can be stored until the subscriber asks that they be printed, at any fax machine he or she specifies, on company premises or offsite (when the subscriber retrieves fax messages remotely).
- **Fax Mail.** Allows subscribers to send fax messages, get fax messages, record personal greetings, and program outcalling.
- **Fax Broadcast.** Provides a simple way to send one fax to as many as 1000 fax numbers.

Call Accounting System (CAS) for Windows

This stand-alone version of CAS takes advantage of the easy-to-use graphical environment offered by Microsoft Windows. Through data communications, it also allows one CAS system to serve multiple business sites.

Group Videoconferencing

Group videoconferencing is supported over DS1 (Digital Signal Level 1) facilities with PRI. (Videoconferencing has been available since Release 2.0.)

Release 2.1 Enhancements (August 1994)

Refer to *Release 2.1 Notes* for detailed descriptions of Release 2.1 enhancements. Release 2.1 includes all Release 2.0 functionality plus the enhancements listed below.

Operational

System operational enhancements include the following:

- When a call is forwarded to a multiline telephone that has an Auto Dial or DSS button programmed for the forwarding telephone, the green light next to the Auto Dial or DSS button for the forwarding telephone does not flash.
- People answering calls received on Cover buttons are allowed to generate touch tones if their telephones are not outward- or toll-restricted.
- Calls received on personal lines with Do Not Disturb on go immediately to coverage instead of waiting for the coverage delay interval.
- A call put on hold at a Cover button can be added to a conference by someone who has a personal line for the call.
- A call put on hold at a Cover button can be picked up by any person who has a personal line for the call.
- Calls that have been put on hold at a Cover, SA, Shared SA, or Pool button can be picked up by a person who has a personal line button for the call.
- An inside call on hold at an SA button can be picked up and transferred by any person with a Shared SA button corresponding to the button with the held call.
- Calls that are on hold awaiting transfer can be picked up by any user who has a personal line for the call.
- Beginning with Integrated Solution III Version 1.2, the automatic reconciliation program that was run automatically at 3:00 a.m. is disabled and can be invoked manually from the User Maintenance menu.
- If an extension is programmed for Forced Account Code Entry, account codes do not have to be entered when using a programmed Loudspeaker Paging button. In addition, an SMDR record is not generated for calls made to paging ports.

- When an MLX telephone, other than an MLX-20L, is plugged into an MLX port and the Personal Directory does not contain any entries, the allocation of the Personal Directory resource is released. If there are any entries in the Personal Directory, the Personal Directory allocation and the entries in the Personal Directory are saved in the MLX port.
- SMDR call records for calls made on PRI facilities are more accurate than SMDR call records for calls made on non-PRI facilities. Outgoing calls made on PRI facilities receive “answer supervision.” Consequently, SMDR timing for calls made on PRI facilities begins when the call is answered. Timing for calls made on non-PRI facilities begins when dialing is completed. Therefore, an SMDR call record is not generated when a call made on a PRI facility is not answered at the far end.
- The Call Type field and the Called Number field on the SMDR report are changed for both the Basic and ISDN report formats.
- An 012 port that is programmed as a generic voice messaging interface (VMI) port can transfer an outside call to an outside number.
- In a system where the transfer audible option is programmed for Music-On-Hold and a music source is provided, outside callers who are transferred to a calling group and are waiting in the queue or who are parked or camped-on, hear music while they are waiting. Internal callers never hear music on hold while waiting in the calling group queue or when they are parked, camped-on, or being transferred to another extension.

Installation and Hardware

Installation and hardware enhancements include the following:

- The control unit covers for the MERLIN LEGEND Communications System are the same easy-to-use covers as those for the MERLIN II Communications System.
- A new 012 (tip/ring) module [apparatus code 517G13 (28) or higher letter] contains a built-in ring generator. The maximum ring equivalency number (REN) supported is 2.2, and the module will ring four ports at one time. Bridging of single-line telephones is not supported because of poor transmission quality.
- A new 008 OPT module (labeled “with RING GEN.”) contains a built-in ring generator. It rings four ports at a time.
- Ferrite cores for the power supply modules are shipped from the factory to comply with FCC Part 15 requirements.
- 3129-WTWA (touch tone outdoor telephone equipped with cast aluminum housing and armored handset cord with bell ringers)
- 3129-WRWA (rotary dial outdoor telephone equipped with cast aluminum housing and armored handset cord with bell ringers).

- 3129-WAWA (auto dial outdoor telephone equipped with cast aluminum housing and armored handset cord with bell ringers).
- 3129-WNWA (nondial, automatic ringing on dedicated circuit outdoor telephone equipped with cast aluminum housing and armored handset cord with bell ringers).

Equipment and Operations

Equipment and operations enhancements include the following:

- A new release (Version 2.16) of the System Programming and Maintenance (SPM) software to support international use.
- Support of PRI connection to DEFINITY, Communications Systems
- MLX-10DP telephone, identical to an MLX-10D, except that it provides a jack for access to the PassageWay™ Solution and PassageWay Direct Connection Solution application.

Additional Application Packages, Telephones, Adjuncts, and Adapter

Additional application packages, adjuncts, and adapter enhancements include the following:

- A Digital Announcer Unit, compatible with all call management systems and tip/ring applications currently available for the MERLIN LEGEND Communications System.
- The HackerTracker™ system software enhancement to the Call Accounting System (CAS) detects abnormal calling activity by allowing monitoring of facilities or authorization code usage.

- A new digital Magic On Hold unit is available in three configurations:
 - Basic Prerecorded Package
 - Personalized Package
 - Custom Production Package
- The MERLIN® Identifier application enables people to receive, store, and use information provided by the local telephone company, specifically, the telephone number of a caller in an area where the service is also supported.
- An Off-Premises Range Extender (OPRE) supports off-premises operation with an off-premises extension capability and extended range operation for tip/ring devices as well as variable gain to improve voice transmission levels.
- PagePac® Plus Loudspeaker Paging Systems do not require system adapters. The controller provides eight built-in zones (expandable to 56 zones by using up to three 16-zone expansion units), group zones, talkback, night bell, operator override, tones, door supervision, microphone input, and system access security codes as standard features.
- PassageWay Solution (Release 1.0) software consisting of four applications that run with Microsoft® Windows™ 3.1 or later and provide an interface between an IBM®-compatible personal computer and the MERLIN LEGEND Communications System.
- Four single-line telephones with memory buttons: 710, 715, 725, and 730.
- Four specialty handsets compatible with all MLX telephones and the 3101 series, 3178-NHL, 8102, and 8110 single-line telephones.

Release 2.0 Enhancements **(October 1992)**

Refer to *Release 2.0 Notes* for detailed descriptions of Release 2.0 enhancements. Release 2.0 includes all Release 1.1 functionality plus the enhancements listed below.

Programming

Programming enhancements include the following:

- Extension Copy is a feature that reduces programming time by allowing the use of any extension as a template for programming another extension or block of extensions through centralized telephone programming.
- Integrated Administration provides a single interface through Integrated Solution III (IS III) for programming entries common to the MERLIN LEGEND Communications System and AUDIX™ Voice Power.

- Any SPM Version 2.xx (where xx is replaced by numbers) provides a Convert function for use in upgrading the system from Release 1.0 or 1.1. This function converts a backup file from a Release 1.0 or 1.1 system to Release 2.0 and later format, allowing reuse of existing system programming on the upgraded system.
- Forced idle reductions keep system interruptions at a minimum. In general, the smallest necessary component is forced idle during programming activities. For example, renumbering a single extension idles only one extension. Only a few systemwide programming activities, such as setting the system mode and system renumbering, idle the entire system.

Operational

System operational enhancements include the following:

- Coverage VMS Off is a feature that prevents incoming outside calls from going to voice mail. (All other coverage remains active as programmed.) The feature is programmed extension by extension, either through extension programming or through centralized telephone programming.
- A Night Service group can be programmed to include either extensions or a calling group as members. You should not program both individual extensions and a calling group into the Night Service group, however, because individuals will not have a chance to answer before calling group members do.
- When AUDIX Voice Power sends a Leave Message notification to an extension, the system identifies the voice mail system as the sender of the message. When the voice mail subscriber uses the Return Call feature, the call goes to any available voice mail port, not just to the specific port that generated the message. This reduces the chance of getting a busy port.
- Coverage receivers can call coverage senders and have the call receive coverage treatment. If a receiver calls a sender for whom he or she is covering, and the sender is busy or unavailable, the call proceeds to other points of coverage. It does not come back to the receiver who originated the call.
- Enhancements to display prompts include automatic posting of a Do Not Disturb message (for MLX display telephones or other multiline telephones, a Posted Message button must be programmed for the Do Not Disturb message to be posted automatically) when a user activates the Do Not Disturb feature, and confirmation messages when a user activates Hold, Privacy, Saved Number Dial, and Transfer.
- Direct Inward Dialing (DID) trunk emulation on a T1 facility provides up to 24 DID channels on a single DS1 interface, instead of requiring 24 separate physical trunks.
- A telephone user can send a timed flash (switchhook flash) on a loop-start trunk call on a System Access (SA) button.

Fax Attendant System™

Fax Attendant is an application for sending and receiving fax messages; its interface is similar to the voice mail interface provided by AUDIX Voice Power. Fax Attendant System, which co-resides with AUDIX Voice Power on the IS III platform, provides the following services:

- **Fax Call Coverage.** Receives and holds messages for subscribers whose fax machines are busy or out of paper. This service also allows a subscriber to have a personal fax number without having a fax machine.
- **Fax Mail.** Allows subscribers to create and use fax distribution lists, send and receive fax messages, and record personal greetings for incoming fax calls.
- **Fax Response.** Prompts callers to select and receive faxes from a customer-created menu of choices, using touch-tone responses.

408 GS/LS-MLX Module

The 408 GS/LS-MLX module (Releases 2.0 and later only) combines four line/trunk jacks for ground-start or loop-start trunks and eight extension jacks for MLX telephones on a single module in the control unit.

Primary Rate Interface (PRI)

Primary Rate Interface (PRI) enhancements include the following:

- Connectivity to the 5ESS® Generic 6
- Multiple incoming calls to directory number
- Call-by-Call Service Selection
- Password handling for FTS2000
- Extension ID as Calling Party Number for Automatic Number ID (ANI)

Maintenance

Maintenance enhancements include the following:

- Clear descriptions of module test failures
- Optional printing of hard copy of error logs
- Display that correlates extension numbers with slot/port and logical ID
- Display showing which slots, trunks, and extensions are maintenance busy
- Internal digital switching element (DSE) loopback test for all modules
- B-channel loopback test for MLX modules
- B-channel line or call service states display
- Error log entries for dual-port RAM errors

Release 1.1 Enhancements **(October 1992)**

Refer to *Release 1.1 Notes* for detailed descriptions of Release 1.1 enhancements. Release 1.1 includes all Release 1.0 functionality plus the enhancements described in the following sections.

Language Selection

This selection allows you to program the system for the display of prompts, menus, and messages on MLX display telephones in English, French, or Spanish. You can also program the following options in any of these languages, independently of the system language:

- Individual extensions with MLX telephones
- System Programming and Maintenance (SPM)
- System programming reports
- SMDR report headers

MLX-10D, MLX-20L, and MLX-28D display telephones and MLX-10 nondisplay telephones are available in three separate versions, with factory-set buttons in English, Spanish, or French. (The MLX-10DP is available in the English version only.) In addition, user and operator guides and telephone tray cards are available in all three languages.

Programming and Maintenance

Programming and maintenance enhancements include the following:

- Additional Inspect capability in system programming.
- Editing capability (Backspace selection) in extension programming.
- Improvements to system reports.
- An access log that records the last 20 times maintenance or system programming has been accessed.
- Longer (20-second) gap between ring cycles for programming mode and Forced Idle tone.

Operational

System operational enhancements include the following:

- Automatic selection of an SA button when Conference is invoked (Hybrid/PBX mode).
- Prompting through Conference feature on MLX display telephones.
- Relocation of the More prompt on the MLX-20L display.
- Display of the number saved on a programmed Last Number Dial or Saved Number Dial button when the button is inspected.

SPM

SPM enhancements include operation in English, French, or Spanish, faster backup and restore, and automatic onscreen display of reports as they are created, with a Browse capability for reading the reports.

Equipment

Additional equipment includes the 8102 and 8110 analog telephones, four headsets, two headset amplifiers, and a transparent protective cover for the MLX-10 and MLX-10D telephones. The 8102 and 8110 telephones are also compatible with Release 1.0.

PF Registration

PF registration number AS5USA-65646-PF-E is assigned by the FCC for operating the MERLIN LEGEND Communications System in Hybrid/PBX mode in the United States. (The PF registration is also applicable to Release 1.0 systems.)

Prior Releases: Features and Enhancements
Release 1.1 Enhancements (October 1992)

ix

About This Guide

The MERLIN LEGEND[®] Communications System is an advanced digital switching system that integrates voice and data communications features. Voice features include traditional telephone features, such as Transfer and Hold, and advanced features, such as Group Coverage and Park. Data features allow both voice and data to be transmitted over the same system wiring.

Intended Audience

This guide provides detailed information about system planning. It is intended for use by anyone who works with customers to plan, coordinate, and implement a system, including support personnel, sales representatives, and account executives. It is also intended for technicians who are responsible for system installation, maintenance, and troubleshooting.

How to Use This Guide

This guide has been designed to provide optimal assistance to you in completing the planning forms—for example:

1. Since some chapters and/or sections apply to one or another of the configurations (Key or Behind Switch, Hybrid/PBX, or data communications), these sections are clearly marked—for example, “Hybrid/PBX Only.” Also, you are alerted to proceed to the next appropriate section, or to skip chapters or sections that do not apply to your particular system. Proceed through this guide as appropriate.
2. A list of forms or information that will be needed for particular procedures appears at the beginning of each chapter and section.
3. Where appropriate, examples of completed forms are included so you can confirm what you have done.

Since this guide assumes that you are familiar with the system, detailed information about equipment, features, and programming are not included. Refer to the following documentation for additional information:

- *System Programming* gives procedural instructions for programming system features.
- User and operator guides give procedural instructions for programming and using telephone features.

“[Related Documents](#),” later in this section, provides a complete list of system documentation, together with ordering information.

In the USA only, Lucent Technologies provides a toll-free customer Helpline 24 hours a day. Call the Helpline at 1-800-628-2888 (consultation charges may apply), or contact your Lucent Technologies representative if you need assistance when installing, programming, or using your system.

Outside the USA, if you need assistance when installing, programming, or using your system, contact your Lucent Technologies authorized representative.

Terms and Conventions Used

The terms described here are used in preference to other, equally acceptable terms for describing communications systems.

Lines, Trunks, and Facilities

Facility is a general term that designates a communications path between a telephone system and the telephone company central office. Technically, a *trunk* connects a switch to a switch—for example, the MERLIN LEGEND Communications System to the central office. Technically, a *line* is a loop-start facility or a communications path that does not connect switches—for example, an intercom line or a Centrex line. In actual usage, however, the terms *line* and *trunk* are often applied interchangeably. In this guide, we use *line/trunk* and *lines/trunks* to refer to facilities in general. Specifically, we refer to *digital facilities*. We also use specific terms such as *personal line*, *ground-start trunk*, *Direct Inward Dialing (DID) trunk*, and so on. When you talk to personnel at your local telephone company central office, ask them which terms they use for the specific facilities they connect to your system.

Some older terms have been replaced with newer terms, as follows:

Old Term	New Term
trunk module	line/trunk module
trunk jack	line/trunk jack
station	extension
station jack	extension jack
analog data station	modem data workstation
digital data station	terminal adapter workstation

Old Term	New Term
7500B data station	ISDN terminal adapter data workstation
analog voice and analog data station	analog voice and modem data workstation
digital voice and analog data station	MLX voice and modem data workstation
analog data-only station	modem data-only workstation
digital data-only station	terminal adapter data-only workstation
7500B data-only station	ISDN terminal adapter data-only workstation
digital voice and digital data station	MLX voice and terminal adapter workstation
MLX voice and 7500B data station	MLX voice and ISDN terminal adapter data workstation

Typographical Conventions

Certain type fonts and styles act as visual cues to help you rapidly understand the information presented:

Convention	Example
Italics or bold indicate emphasis.	It is <i>very</i> important that you follow these steps. WARNING: Do not remove modules from the carrier without following proper procedures.
Italics also set off special terms.	The part of the headset that fits over one or both ears is called a <i>headpiece</i> .
Plain constant-width type indicates text that appears on the telephone display or PC screen, as well as characters you dial at the telephone or type at the PC.	Choose <code>Ext Prog</code> from the display screen. To activate Call Waiting, dial <code>*11</code> .

Product Safety Advisories

Throughout these documents, hazardous situations are indicated by an exclamation point inside a triangle and the word *CAUTION* or *WARNING*.



WARNING:

Warning indicates the presence of a hazard that could cause death or severe personal injury if the hazard is not avoided.



CAUTION:

Caution indicates the presence of a hazard that could cause minor personal injury or property damage if the hazard is not avoided.

Security

Certain features of the system can be protected by passwords to prevent unauthorized users from abusing the system. You should assign passwords wherever possible and limit distribution of such passwords to three or fewer people.

Nondisplaying authorization codes and telephone numbers provide another layer of security. For more information, see [Appendix A](#), "[Customer Support Information](#)."

Throughout this guide, toll fraud security hazards are indicated by an exclamation point inside a triangle and the words *SECURITY ALERT*.



SECURITY ALERT:

Security Alert indicates the presence of a toll fraud security hazard. Toll fraud is the unauthorized use of your telecommunications system, or use by an unauthorized party (e.g., persons other than your company's employees, agents, subcontractors, or persons working on your company's behalf). Be sure to read "Your Responsibility for Your System's Security" on the inside front cover of this guide and ["Security of Your System: Preventing Toll Fraud"](#) in [Appendix A](#), ["Customer Support Information."](#)

Related Documents

The documents listed in the following table are part of the MERLIN LEGEND documentation set. Within the continental United States, contact the Lucent Technologies BCS Publications Center by calling 1-800-457-1235.

Document No.	Title
System Documents:	
555-670-100	<i>Customer Documentation Package:</i> Consists of paper versions of the <i>System Manager's Quick Reference</i> , the <i>Feature Reference</i> , and <i>System Programming</i>
555-670-110	<i>Feature Reference</i>
555-670-111	<i>System Programming</i>
555-670-112	<i>System Planning</i>
555-670-113	<i>System Planning Forms</i>
555-670-116	<i>Pocket Reference</i>
555-670-119	<i>System Manager's Quick Reference</i>
555-661-150	<i>Network Reference</i>
555-670-800	<i>Customer Reference CD-ROM:</i> Consists of the <i>System Manager's Quick Reference</i> , the <i>Feature Reference</i> , <i>System Programming</i> , and the <i>Network Reference</i>
Telephone User Support:	
555-660-122	<i>MLX Display Telephone User's Guide</i>
555-630-150	<i>MLX- 5D, MLX-10D and MLX-10DP Display Telephone Tray Cards (5 cards)</i>

Document No.	Title
555-630-152	<i>MLX-28D and MLX-20L Telephone Tray Cards (5 cards)</i>
555-660-124	<i>MLX-5[®] and MLX-10[®] Nondisplay Telephone User's Guide</i>
555-630-151	<i>MLX-5 and MLX-10 Nondisplay Telephone Tray Cards (6 cards)</i>
555-630-155	<i>MLX-16DP Display Telephone Tray Cards (5 cards)</i>
555-660-120	<i>Analog Multiline Telephones User's Guide</i>
555-670-122	<i>MLS and ETR Telephone Tray Cards</i>
555-660-126	<i>Single-Line Telephones User's Guide</i>
555-660-138	<i>MDC and MDW Telephones User's Guide</i>

System Operator Support:

555-660-134	<i>MLX Direct-Line Consoles Operator's Guide</i>
555-660-132	<i>Analog Direct-Line Consoles Operator's Guide</i>
555-660-136	<i>MLX Queued Call Console Operator's Guide</i>

Miscellaneous User Support:

555-661-130	<i>Calling Group Supervisor and Service Observer User Guide</i>
555-650-105	<i>Data and Video Reference</i>

Documentation for Qualified Technicians:

555-670-140ADD	<i>Installation, SPM, Maintenance and Troubleshooting Supplement</i>
----------------	--

Toll Fraud Security:

555-025-600	<i>BCS Products Security Handbook</i>
-------------	---------------------------------------

System Documents:

555-670-100	<p><i>Customer Documentation Package:</i></p> <p>Consists of paper versions of the <i>System Manager's Quick Reference</i>, the <i>Feature Reference</i>, and <i>System Programming</i></p>
-------------	---

How to Comment on This Guide

We welcome your comments, both positive and negative. Please use the feedback form on the next page to let us know how we can continue to serve you. If the feedback form is missing, write directly to:

Documentation Manager
Lucent Technologies
211 Mount Airy Road, Room 2W-330
Basking Ridge, NJ 07920

Before You Begin

1

You should perform several tasks before you begin filling out the planning forms for the system:

- Review the system's hardware, features, and operation as defined at the time of purchase.
- Confirm the location of the control unit.
- Obtain the required information from the local telephone company.
- Obtain information about telephone users and their needs.
- Obtain or develop a floor plan of the customer's site.

Each of these preplanning tasks is described in this chapter.

Reviewing System Components

To tailor the system to the customer's business, you must know the number and types of telephones, outside lines/trunks, and adjuncts that were ordered. You also need to know how the equipment will be used—for example, which type of telephone is assigned to each employee, which consoles operators will be using, and where adjuncts will be located.

Review the list of equipment ordered. If you did not participate in the ordering process, you may want to confer with the customer representative who did. You also may want to conduct a premises check to determine whether any additional equipment is required.

Confirming the Location of the Control Unit

Before installation, a room, closet, or other area must be designated where the system control unit can be mounted on the wall. The area must meet the environmental requirements in [Table 1-1](#).

Table 1-1. Environmental Requirements

Conditions...	Requirements...
Distances	Within 25 cable feet (7.6 m) of the network interface (cannot be installed outdoors) Within 1000 cable feet (304.8 m) of telephones Within 5 cable feet (1.5 m) of a dedicated AC power outlet (one outlet for every carrier)
Heat Dissipation	Fully loaded basic carrier: 500 Btu/hr (35 cal/sec) Fully loaded 2-carrier: 1000 Btu/hr (70 cal/sec) Fully loaded 3-carrier: 1500 Btu/hr (105 cal/sec)
Power	Basic carrier: 117 VAC60 Hz \pm 5% 160 W 5.4 amps 2-carrier: 117 VAC60 Hz \pm 5% 320 W 10.8 amps 3-carrier: 117 VAC60 Hz \pm 5% 480 W 16.2 amps one properly grounded outlet needed for each carrier Additional outlets may be needed if installing printers and PCs.
Temperature	40° through 104°F; 4° through 40°C (optimal temperature 60°F; 16°C)
Humidity	20% through 80% relative humidity
Ventilation	Allow at least 1 inch (2.5 cm) of space on the right and left sides of the control unit and 12 inches (30.5 cm) above and below the control unit to prevent overheating.



CAUTION:

The AC outlet for the control unit should not be switch-controlled. Plugging the control unit into an outlet that can be turned on and off by a switch can cause accidental disconnection of the system.

The AC outlet must be properly grounded by using an AC receptacle for a 3-prong plug.

Do not install the control unit outdoors.

Do not place the control unit near extreme heat (furnaces, heaters, attics, or direct sunlight).

Do not expose the control unit to devices that generate electrical interference (such as arc welders or motors).

Do not expose the control unit to moisture, corrosive gases, dust, chemicals, spray paint, or similar material.

Do not place anything on top of the carriers.

Do not install the control unit under any device that may drip fluid, such as an air conditioner.

In addition, a backboard is needed to mount the system on the wall. One can be made locally from 3/4 inch (1.9-cm) plywood. The dimensions depend on the number of carriers, as shown in [Table 1-2](#). A newly designed, pre-drilled, light-weight plastic backboard may be ordered (COMCODE 847007523). In some areas, fire or electrical codes require a flame-retardant backboard. Check with the appropriate authorities to ensure that the proper material is provided. A template, which shows the layout for mounting equipment, is available (COMCODE 847009206). It comes with safety, electrical, environmental, and space requirements for the communications system.

Table 1-2. Control Unit Space Requirements

Part...	Requirements...
Carrier	
Basic carrier	14 inches wide x 23 inches high x 12 inches deep (35.6 cm. x 58.4 cm. x 30.5 cm.)
Basic carrier + 1 expansion carrier	25 inches wide x 23 inches high x 12 inches deep (63.5 cm. x 58.4 cm. x 30.5 cm.)
Basic carrier + 2 expansion carriers	37 inches wide x 23 inches high x 12 inches deep (94 cm. x 58.4 cm. x 30.5 cm.)
Backboard	
Without Systimax [®]	6 feet wide x 3 feet high x 3/4 inches deep (182.9 cm. by 91.4 cm. x 1.9 cm.)
With Systimax	7 feet wide x 4 feet high x 3/4 inches deep (213.4 cm. x 121.9 cm. x 1.9 cm.)

It is important that the location selected for the control unit meets all of these specifications and that the backboard is in place before installation. If the location has already been selected and changes are needed, arrange for these changes before installation.

Grounding Requirements

Proper grounding of the installation site is essential for correct and safe functioning of the system. Grounding protects the system against:

- Lightning
- Power surges
- Power crosses on outside lines/trunks
- Electrostatic discharge (ESD)

The telephone company is responsible for providing protection of outside lines/trunks at the entrance to the site. The protection should consist of:

- Carbon blocks or gas-discharge tubes connected to an approved ground.
- Adequate bonding of the outside line/trunk protector ground and the power-company ground.



CAUTION:

Improper ground can result in equipment failures and service outages. Verify that the AC power uses an approved ground for its primary ground and that all voltage-limiting devices are attached to an approved ground. Approved grounds are as follows:

- The metal frame of the building.
- A metal water pipe connected to an underground water pipe that is in direct contact with earth.
- An electrode encased by at least 2 inches (5 cm) of concrete and located within and near the bottom of a concrete foundation or footing in direct contact with earth.
- A copper ring that encircles the building and is in direct contact with earth.

For most surge occurrences, the following standard grounding requirements provide adequate lightning and power surge protection:

- Properly wired, grounded, and bonded outside line protectors.
- Properly wired and grounded AC outlet.
- Properly grounded single-point ground bar.
- Properly wired connection between single-point ground and power supply.

Electrical Noise/Radio-Frequency Interference

In most cases, electrical noise is introduced to the system through lines/trunks or telephone cables. However, electromagnetic fields near the control unit may also induce noise in the system. The control unit and cable runs, therefore, should not be placed in areas where a high electromagnetic field strength exists. Radio transmitters (AM and FM), television stations, induction heaters, motors (with commutators) of 1/4 horsepower (200 watts) or greater, and similar equipment are leading causes of interference. Small tools with universal motors do not generally cause a problem when operated on separate power lines. Motors without commutators generally do not cause interference.

Field strengths below 1.0 volt per meter are unlikely to cause interference. Estimate the field strength produced by radio transmitters by dividing the square root of the emitted power (in kilowatts) by the distance from the antenna in kilometers.

This yields the approximate field strength in volts per meter and is relatively accurate for distances greater than about half a wavelength (492 feet, or 150 meters, for a frequency of 1000 Hz).

To comply with FCC Part 15 requirements, each power supply on a newly installed system must have a ferrite core installed around the AC power cord and ground wire. Beginning with Release 2.1 this ferrite core is packaged with the power supply module at the factory. Ferrite cores are also compatible with earlier releases.

Requirements for Supporting CTI Applications

If your site will take advantage of the Computer Telephony Integration (CTI) capabilities of the MERLIN LEGEND Communications System (Release 5.0 or later), each Client Desktop must have one extension associated with a computer that is networked to a Telephony server which, in turn, is connected to the MERLIN LEGEND Communications System through a CTI link. [Figure 1-1 on page 1-7](#) shows the system configuration for support of CTI applications.

Use the following resources and procedures to implement a CTI application.

1. Complete the appropriate MERLIN LEGEND/Telephony Services Preliminary Survey for the application being sold.
 - The Preliminary Survey is available from the Sales and Design Support Center (SDSC) Techni-Fax (1-888-297-4700—select the appropriate prompts), or from IntraWorks at http://www.bcs.lucent.com/tech_info/sdsc/forms.
 - The survey is completed by the Account Executive (AE) and customer.
2. Contact SDSC for CTI presale support.
 - The AE should contact SDSC (1-888-297-4700—select the appropriate prompts to reach the MERLIN LEGEND split) to discuss customer requirements and potential solutions. If the CTI solution is deemed appropriate, then the AE must obtain the appropriate MERLIN LEGEND/Telephony Services Preliminary Survey.
3. Return the completed survey after the sale is made.
 - The AE will coordinate and monitor the relationship between the OEM and the customer.
 - The AE will put the DOSS Order Number on the completed survey.

- For Phonetastic:
 - Fax the completed survey to the Phonetastic™ Outsource Partner Desk (1-801-984-1120, Attention Phonetastic Outsource Coordinator).
 - The OEM will assign an Outsource Partner.
 - The OEM will establish an implementation date with the customer.
 - The OEM Outsource Partner will complete the Statement of Work for the customer.
4. Statement of Work (SOW)
- Defines all duties performed by the OEM Outsource Partner.
 - Defines customer expectations.
 - Defines customer responsibilities.
 - Once the customer and the Outsource Partner have signed the SOW, it will be sent back to the AE to be included in the customer contract package.
5. Implementation Considerations for OEM Outsource Partners
- Application installation requires a six-week interval. Early coordination will be required to enable a smooth implementation.

Incoming/Outgoing
Calls

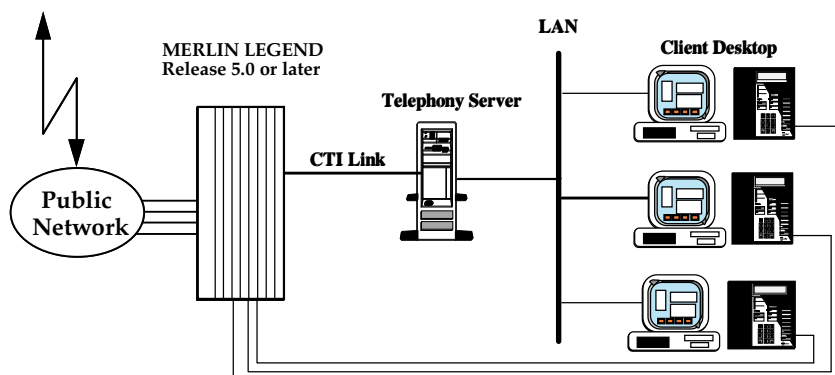

Figure 1-1. System Configuration for Support of CTI Applications

For this configuration you must have the following equipment and software:

- For Novell NetWare® Version 3.12, 4.1, or 4.11:
 - An Intel i386, Intel i486, or Pentium Class computer with at least 16 MB of RAM. Additional memory may be needed if additional applications will be running on the server machine. Refer to the MERLIN LEGEND *Network Manager's Guide* for more information.
 - MERLIN LEGEND PassageWay® Driver Version 1.1 or later installed.
 - Telephony Services for NetWare software, Release 2.2.1 or later installed.
 - An Eicon SCOM ISDN BRI card for the CTI link.
 - A free 8- or 16-bit ISA slot for the ISDN BRI card.
 - 5 MB of disk space on the SYS (system) volume.
 - Either Interrupt 2 or Interrupt 3 available.
- For Microsoft Windows NT® 4.0 Server or Workstation (Windows NT 4.0 Server is recommended):
 - A 486-class or Pentium computer with a CD-ROM and at least 32 megabytes of RAM and 11 megabytes of disk space. Additional memory may be needed if additional applications will be running on the Telephony Server machine.
 - MERLIN LEGEND NT PBX Driver Version 1.0 or later installed.
 - CentreVu® Telephony Services for Windows NT software, Release 3.10 or later.
 - An Eicon DIVA Version 2.01 ISDN BRI card for the CTI link.
 - A free 16-bit ISA slot for the ISDN BRI card.
- System software Release 5.0 or later installed on the MERLIN LEGEND Communications System.
- The MERLIN LEGEND Communications System configured in Hybrid/PBX mode.
- An MLX module with extension ports installed in the MERLIN LEGEND Communications System. This module must have the proper firmware or application vintage:
 - If a "U" appears after the module name in the System Inventory screens, check for the proper Application Vintage:
 - 008-MLX—27 or later
 - 408 GS/LS-MLX—27 or later
 - 408 GS/LS-ID-MLX—27 or later
 - 016 MLX (Release 7.0 or later systems)—12

1 Before You Begin

Requirements for Supporting CTI Applications

1-9

- If no “U” appears after the module name in the System Inventory screens, check for the proper Firmware Vintage:
 - 008-MLX—28 or later, *but not 29*
 - 408 GS/LS-MLX—28 or later, *but not 29*
 - 408 GS/LS-ID-MLX—28 or later, *but not 29*



NOTE:

If you have Version 29, replace the module with an appropriate version or, for a replacement card, call the TSO at: 1-800-628-2888.

- If the MERLIN LEGEND Communications System has only one MLX extension module, you will also need System Programming and Maintenance (SPM) software, Version 5.15 or later, to program your CTI link.
- One extension port on an MLX module is used for the link. Select from ports 2, 3, 4, 6, 7, or 8 on an 008 MLX, 408 GS/LS-MLX, or 408 GS/LS-ID-MLX module. In Release 7.0 and later systems, you can also select ports 2, 3, 4, 6, 7, 8, 10, 11, 12, 14, 15, or 16 on an 016 MLX module. The CTI link port cannot be the potential operator port or the console programming port.
- For a NetWare 3.12 installation, ensure that NWSNUT.NLM, Version 4.11 or later, and TUI.NLM, Version 1.04 or later, is obtained from Novell and installed in the SYS:\SYSTEM directory.



NOTE:

To obtain these NLMs from Novell, access either the Novell web site (<http://www.novell.com>) or the Novell FTP site (<ftp.novell.com>). First download IPXRT4.EXE and follow the directions in the associated readme file. Then, download NWSNUT.NLM and TUI.NLM.

- For a Windows NT installation, the required .DLLs and drivers will be provided on a CD-ROM.

For more information on setting up the system, see the MERLIN LEGEND Communications System *Network Manager's Guide*.

Environmental Specifications

If the Telephony Server platform and the MERLIN LEGEND Communications System are to share an equipment room, the room's environment (temperature, humidity, contaminants, EMI, AC power and grounding) must meet the more demanding set of environmental specifications for the two units. Refer to the specifications for each hardware platform for details.

Obtaining Telephone Company Information

To fill out many of the forms, especially forms involving incoming lines/trunks, you need to obtain information from the local telephone company. Before you speak with the local telephone company, make sure you understand your customer's company requirements regarding the communications system. Some of the information you will need to know includes:

- Which incoming line/trunk connects to each channel on each 100D module, and the order in which the lines/trunks are assigned.
- The Service Profile Identifier (SPID) and Directory Number (DN) associated with each channel on each 800 NI-BRI module.
- Whether the disconnect signals for loop-start lines/trunks are reliable or unreliable, and the length of the Hold disconnect interval.

Information the local telephone company can provide includes:

- Detailed T1 parameters
- Detailed NI-1 BRI parameters
- Number of digits sent on DID trunks
- Any lines/trunks that require a toll-call prefix
- Telephone number for each incoming line/trunk
- Type or types of incoming lines/trunks (loop-start, ground-start, and so on)
- Any lines/trunks that are rotary-dial

Obtaining User Information

The features and calling privileges you assign to each employee's telephone ensure that employees get the most benefit from the system. If you were not involved in the planning and equipment-ordering for the system, you should discuss the system's design with the customer representative who took part.

To determine calling privileges, answer the following questions:

- Does management want to allow both local and toll calls to be made from every telephone?
- If any telephones are restricted, are there any numbers the users should be allowed to call?
- Are there any specific numbers (such as 900) that you want to restrict users from calling?
- Who, if anyone, will be given personal lines?
- Will access to central office lines/trunks (outside lines) be restricted to certain employees?
- Do any departments (such as sales and service) receive frequent special calls that should come to them directly, bypassing a system operator?
- Do any departments or extensions need to screen incoming calls?

You may want to use the Employee Communication Survey Form to determine each employee's telecommunications needs. A copy of this form is in [Appendix B](#) and is included in the forms package. Since a survey form should be completed for each user, make as many copies of the form as you need.

If it is not feasible for each employee to fill out a form, get the information you need from a knowledgeable person in each department, section, or work group. This person should have sufficient information and authority to make decisions about calling features and coverage assignments for others in the department.

Use the information in [Table 1-3](#) to interpret and analyze the results of the Employee Communication Survey. Numbers for items in the Required Information column correspond to question numbers on the survey.

Table 1-3. Employee Communications Survey: Description of Questions

Required Information...	Description...
1. Types of lines/trunks (outside lines) used	Indicates toll-calling habits. In most cases, assigning a button for each line/trunk is not necessary; the use of Automatic Route Selection (Hybrid/PBX mode only) ensures that the preferred line/trunk is selected.
2. Calls covered by someone else (sender)	Suggests that this employee should be assigned as a sender in either an Individual or a Group Coverage arrangement, particularly if calls are covered by someone other than the operator.
3. Shares lines/telephone numbers	Identifies Shared System Access buttons and/or common personal line appearances.

Table 1-3. Employee Communications Survey: Description of Questions — Continued

4. Covers someone else's calls (receiver)	Suggests assignment as a receiver in someone else's Individual or Group Coverage arrangements.
5. Shares incoming calls	Identifies calling group needs.
6. Frequency of use	Identifies heavy and light telephone users. Heavy users may benefit from additional System Access buttons and/or an additional System Access Originate Only button.
7. Data needs	Identifies existing and potential data terminal and personal computer users.
8. Use of account codes	Identifies current account codes used for charge-back of calls if there is a programmed Account Code button on the telephone and if the system includes Call Accounting System (CAS).
9. Frequently dialed numbers	Identifies useful numbers for the System Speed Dial list.
10. Picks up calls	Identifies the need for a Pickup group.
11. View incoming caller information	Identifies which telephone users need call screening capabilities. This service may be part of the local telephone company's services, if available, and must be subscribed to.

Obtaining a Floor Plan

You may want to use a floor plan to make planning more manageable and to ensure that the correct telephone equipment is assigned to each employee. If the customer does not already have a floor plan showing the location of system equipment, you should create one. Use the symbols shown in [Figure 1-2](#) and the following instructions:

1. Use a large sheet of paper and sketch the office layout. The location of office walls and other partitions is important when features are assigned to telephones that must be within hearing range of each other. For example, pickup group members must be able to hear each others' telephones ringing.
2. Indicate the location of each employee's telephone, other locations that will have a telephone (such as a conference room), and the locations of data terminals, PCs, and host computers.
3. Indicate the type of telephone at each location, using an abbreviation that includes the number of programmable buttons. For example, write **MLX-10** at 10-button MLX telephones, **MLX-20L** at 20-button MLX display telephones, **BIS-34** at 34-button analog multiline telephones, and so on.

1 Before You Begin

Obtaining a Floor Plan

1-13

4. Indicate the type of adjunct at each location. For example, write **FAX**, **ana.modem** (analog modem), **headset**, or other type of adjunct beneath the symbol.
5. Indicate any additional equipment, such as a Station Message Detail Recording (SMDR) printer, Call Accounting System device, equipment required for off-site telephones, and so on.
6. Indicate the locations where AC power is available and/or required, for example, for a Multi-Function Module (MFM), a console with two Direct Station Selectors (DSSs), or an Integrated Services Digital Network (ISDN) terminal adapter.

The floor plan does not need to be elaborate or to scale. Keep the floor plan on hand. Refer to it during planning and complete it (by filling in extension numbers) when you get to [“Numbering the System”](#) in [Chapter 2](#).

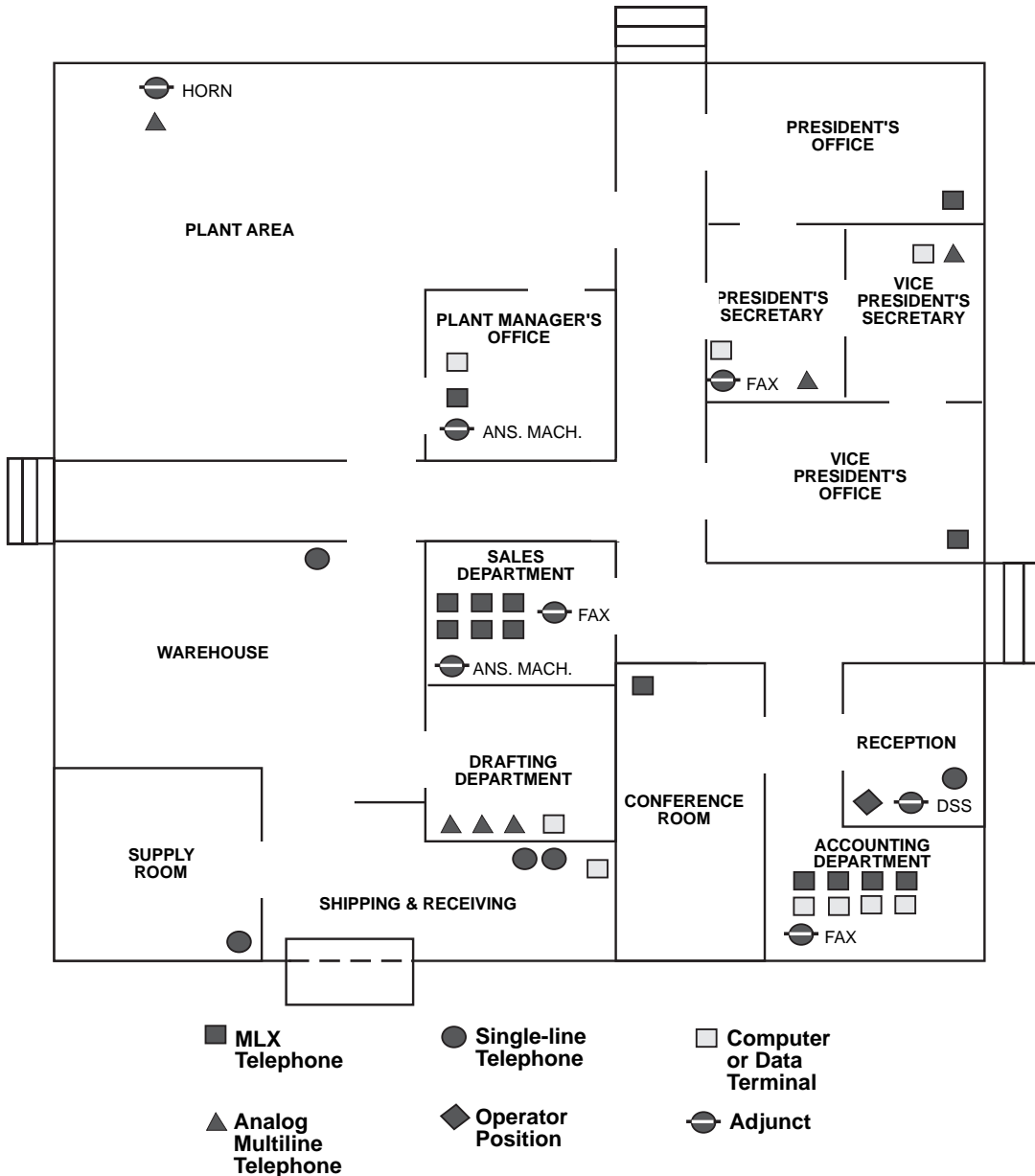

Figure 1-2. Sample Floor Plan

Control Unit Configuration

2

After you have completed the preplanning tasks described in [Chapter 1](#), “[Before You Begin](#),” you can plan the control unit configuration. Planning the control unit configuration consists of the following tasks:

- **Planning Module Placement.** Calculate the system’s line/trunk and extension capacity according to the number of module types; then map out the placement of the modules on the Control Unit Diagram.
- **Recording System Operating Conditions.** Note the system’s type of programming equipment, it’s mode and language choice, and whether the Automatic Maintenance Busy feature is to be enabled or disabled.
- **Numbering the System.** Decide the order in which to connect the telephones and other equipment to the control unit based on the customer’s needs and applications. Determine whether the system-assigned extension numbers are appropriate for the customer’s business or if they need to be renumbered.

This chapter contains instructions for completing each of these tasks.

Planning Module Placement

In addition to the processor module and power supply module, the system supports several types of line/trunk and extension modules. Deciding how to place the modules in the carriers consists of the following tasks:

- Calculating the system’s line/trunk capacity according to module types.
- Calculating the system’s extension capacity according to module types.
- Mapping out module placement on the Control Unit Diagram, according to specific guidelines.

This section contains instructions for each of these tasks.

For information about calculating unit load requirements, see [Appendix F](#), “[Unit Load Calculation](#).”

For detailed information about modules and their specifications (including line/trunk and extension capacity), see the descriptions of hardware components contained in the *Pocket Reference*.

Forms Needed

- Equipment List (if available)
- Form 1, System Planning

Capacity for Lines/Trunks

Line/trunk capacity is the number of lines/trunks that can be connected to the control unit. This section contains instructions for calculating the systems capacity for lines/trunks, according to the system's module types.

Planning Form Instructions

1. In the table in the Line/Trunk Capacity section of Form 1, System Planning, fill in the number of each type of line/trunk module on the appropriate line of the Number of Modules column.
2. Add the column and record the result at the bottom of the column on the System Totals line.
3. For each module type noted, multiply the value in the Number of Modules column by the value in the Trunks Supported by Module column; write the results in the appropriate row under Total Trunks by Module Type.
4. Add the column and record the total line/trunk capacity of the system at the bottom of the column, on the System Totals line.

Capacity for Extensions

Extension capacity is the number of extensions that can be connected to the control unit. In most cases, the number of physical jacks on the modules indicates capacity. Most loop-start and ground-start modules have one or two power-failure transfer (PFT) jacks connected to a single-line telephone in case of a power failure, and not counted in system capacity. Every four line jacks has one associated PFT jack.

One extension number is automatically assigned to each extension jack, whether or not equipment is connected to it, except for the following modules:

- **008 MLX, 016 MLX (Release 7.0 and later systems), 408 GS/LS-MLX, and 408 GS/LS-ID-MLX Modules.** Two extension numbers are assigned to each physical extension jack: the first for an MLX telephone and the second for any equipment connected to the telephone through an MFM, ISDN terminal adapter, or any 2B data desktop video endpoint.
- **008 OPT Module.** The system recognizes this module as an 012 (T/R) module. Therefore, even though the OPT module has only 8 physical jacks, it uses 12 ports of capacity. An extension number is assigned to each of the 8 physical jacks and to each of the four “phantom” jacks.

This section contains instructions for calculating the system’s extension capacity according to the number of certain module types.

Planning Form Instructions

1. In the table under the Extension Capacity section of Form 1, fill in the number of each type of extension module on the appropriate line of the Number of Modules column.
 - Each 100D module is assigned 24 logical IDs, even though the module has only 1 physical trunk jack.
 - Each 800 NI-BRI module is assigned 2 logical IDs per physical trunk jack for a total of 16 logical IDs.
2. Add the column and record the result at the bottom (System Totals line).
3. For each module, multiply the value in the Number of Modules column by the value in the Physical Jacks per Module column and record the results on the appropriate line in the Physical Jacks by Module Type column.
4. Add the column and record the result at the bottom (System Totals).
5. To determine the number of extensions assigned for each module type, multiply the value in the Physical Jacks by Module Type column by the value in the Extensions Assigned column and write the results in the appropriate row in the Total Extensions Assigned column.



NOTE:

Since the system assigns an additional four extensions to each 008 OPT module, you must first calculate the Extensions Assigned by multiplying the number of 008 OPT modules (noted in the Number of Modules column) by 4 and then add this subtotal to the number noted in the Physical Jacks by Module Type column.

6. Add the column and record the result at the bottom (System Totals).

Control Unit Diagram—Module Placement

This section describes how to use the Control Unit Diagram on Form 1 (page 2) to map the placement of the modules according to certain guidelines. [Figure 2-1 on page 2-7](#) provides an example of a Control Unit Diagram for a system with 32 lines/trunks and 52 extensions. In addition, this section describes how to identify each jack on each module with respect to type (line/trunk or extension) and its associated logical ID. Each physical jack on the control unit is numbered sequentially from bottom to top and left to right with logical IDs as follows:

- Extension jacks are numbered from 1 to 200.
- Line/trunk jacks are numbered from 1 to 80.

This sequence of logical IDs is the basis for connecting components to the control unit, as well as for the assignment of extension numbers and line/trunk numbers.

Planning Form Instructions



NOTE:

The Unit Load blocks above the diagram are reserved for equipment changes or maintenance. A Lucent Technologies representative or authorized dealer computes these values manually.

1. On the Control Unit Diagram of Form 1 (page 2), record the type of module to be installed in each slot by writing the module name (for example, 008 MLX) on the slanted lines at the top of each slot. Use the following guidelines:
 - a. Indicate the power supply module in the far left slot of each carrier.
 - b. Indicate the processor module in Slot 00 of the basic carrier.
 - c. Indicate line/trunk and extension modules in any order in Slots 01 through 17, with the following conditions:
 - Group the modules in each carrier from left to right with no empty slots between modules. (The system does not recognize modules in slots that follow an empty slot; slots to the right of the last module can be left empty.)
 - (Hybrid/PBX mode only) If the system includes a Queued Call Console (QCC), the first line/trunk and/or extension module must be a 408 GS/LS-MLX, 408 GS/LS-ID-MLX, 008 MLX module, or 016 MLX (Release 7.0 or later systems).

- (All modes) Current 012 (T/R), 008 OPT, and 016 (T/R) modules have built-in ring generators and are compatible with earlier releases. The 012 (T/R) module [517J13 (28)] has a ring equivalency number (REN) of 2.2 and rings only four ports at a time, although eight jacks can be used for applications. The 016 T/R module (517C34) has a REN of ≥ 4 , can ring 16 ports at a time, and has no restriction on the number of jacks that can be used for applications. The 412 LS-ID-ETR and 016 ETR modules (Release 7.0 and later systems) have a REN of 3 and can ring all tip/ring ports at the same time.
- Group all 800 DID, 100D, 800 NI-BRI, and 400EM modules together according to type; this helps save time in system programming.



NOTES:

- Due to limitations in the 391A, 391A1, and 391A2 power supplies, the number of 800 NI-BRI modules plus 100D modules in a single carrier cannot exceed three. If you have more than three modules, you must install the additional modules in an expansion carrier. This restriction does not apply to the 391C1 or 391A3 power supply.
- The 391C1 power supply has a maximum rating of 96 unit loads; the 391A3 power supply has a maximum rating of 72 unit loads. If your system contains a 391A1 or 391A2 power supply module, and the unit loads for that carrier will exceed 48, a 391C1 or 391A3 power supply should be installed in the system.
- Due to power supply limitations, the maximum number of MLX telephones per carrier can vary, as shown in [Table 2-1](#).

Table 2-1. Power Supplies and MLX, ETR, and MLS Telephones

Power Supply	Maximum No. of MLX, ETR, or MLS Telephones per Carrier
391A1	48
391A2	48
391A3	72
391C1	96

- In Release 6.0 or later, if the switch is part of a private network and a tandem PRI trunk (programmed as Legend-PBX or Legend-NTWK) has some B-channels that would bring the total number of trunks over the system limit of 80, the 100D module for that tandem PRI trunk should be placed in the last slot in the carrier. In this manner, the 100D module will contain the last lines in the system, and any B-channel over the 80 line/trunk limit will be ignored. However, the D-channel will still function even if the 100D module exceeds the line capacity of the system. The number of B-channels must be the same on each networked system. See the *Network Reference* for additional information.
2. For each line/trunk and extension jack of each module, write the type of jack (X = extension; and L/T = line/trunk) and the associated logical ID, keeping in mind the following:
 - Each 100D module is assigned 24 logical IDs, even though the module has only 1 physical trunk jack.
 - Each 800 NI-BRI module is assigned 2 logical IDs per physical trunk jack for a total of 16 logical IDs.
 - The 008 OPT module is assigned 12 logical IDs, even though the module has only 8 physical extension jacks.
 - Power-failure transfer (PFT) jacks are not assigned logical IDs.

 **NOTES:**

- If the system has one or more PFT telephones (maximum: 20), indicate on the Control Unit Diagram the modules that will have PFT telephones connected to their PFT jacks; write PFT in the modules. A PFT telephone can be connected to a PFT jack on a 400 (LS), 400 GS/LS/TTR, 800 (LS), 800 GS/LS, 800 GS/LS-ID, 408 (LS-ATL), 408 GS/LS-ATL, 408 GS/LS-MLX, or 408 GS/LS-ID-MLX module. Touch-tone PFT telephones must be connected to jacks with touch-tone lines/trunks.

2 Control Unit Configuration

Recording System Operating Conditions

The 412 LS-ID-ETR module does not have a separate dedicated PFT jack. In the event of a power failure, however, the topmost (#12) extension jack automatically operates as a tip/ring port. You may then plug in a single-line telephone to the top extension jack.

- You need a ground-start button on a PFT telephone connected to a ground-start trunk.

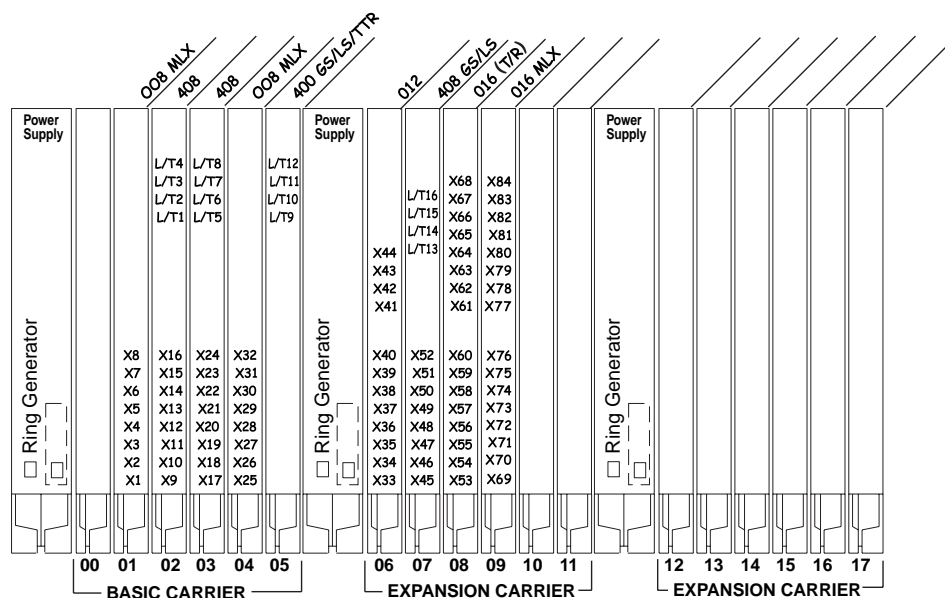

Figure 2-1. Sample Control Unit Diagram

Recording System Operating Conditions

This section contains instructions for recording the following system operating conditions:

- Programming equipment to be used and its extension jack assignment
- Mode of operation
- Language choice
- Enable and disable Automatic Maintenance Busy

2 Control Unit Configuration

Recording System Operating Conditions

2-8

- A reminder to set the system date
- Backup schedule
- Identifying system console extensions
- Second Dial Tone Timer
- Identifying system applications

Forms Needed

Form 1, System Planning

Programming Equipment

Two types of equipment can be used for system programming:

- An MLX-20L telephone identified as a system programming console. The telephone is connected to the first (lowest) extension jack (which is factory-set for system programming) on the first MLX module.
- A personal computer with System Programming and Maintenance (SPM) software. The PC connects to the lowest jack on the processor module.

Planning Form Instructions

1. Under the Programming Equipment heading in the System Operating Conditions section on Form 1 (page 2), do *either* of the following:
 - If the system will use a system programming console, check the System Programming Console box.
 - If the system will use a PC with SPM software, check the PC with SPM Software box.



NOTES:

- In conjunction with the MLX-20L telephone and the PC, a PCMCIA card is required for Release 3.0 and later of the communications system. Check the box labeled PCMCIA Memory Card.
- The first (lowest) extension jack on the first MLX module is factory-set for system programming and as the primary operator position. Since the primary operator position cannot be reassigned, you may want to change the system programming assignment to ensure that future programming sessions do not interfere with the operator's work.

2 Control Unit Configuration

Recording System Operating Conditions

2-9

2. Do *either* of the following:
 - If you checked System Programming Console, proceed to Step 3.
 - If you checked PC with SPM Software, skip to the next section, "[System Mode](#)."
3. To change the factory-set system programming jack, write in the new logical ID using the information from the Control Unit Diagram.

If you want the system programming jack to be different from that of system operators, change the programming assignment to any one of extension jacks 2 through 5 on the first MLX module in the control unit (the lowest jack on the module is extension jack 1). You fill in the extension number of the jack later.

System Mode

The mode of operation determines how outside lines/trunks are provided to users, the types of operator consoles allowed, the features available, and how they work. Each system is registered with the Federal Communications Commission (FCC) to operate as a Private Branch Exchange (PBX), Hybrid, or Key system (factory setting). However, you can program the system to operate in any of the three modes: Hybrid/PBX, Key, or Behind Switch.

Planning Form Instructions

Under the System Mode heading in the System Operating Conditions section of Form 1 (page 2), check *one* of the following:

- If the system will operate in Key mode, check Key. (This is the factory setting.) If need be, this mode can be changed to Hybrid/PBX mode at another time.
- If the system will operate in Hybrid/PBX mode, check Hybrid/PBX.
- If the system will be connected behind a larger system or a Centrex system, check Behind Switch and record the host's dial codes for the Transfer, Conference, and Drop features so users can access these features on the larger system.
- If you check Permanent Key, the switch in the back of the processor module must be placed in the Permanent Key position. The switch cannot be changed without changing the FCC registration of the system.

Language Selection

In Release 1.1 and later versions of the system, language-specific operation is available in English, French, and Spanish. The language selection affects prompts and displays on user telephones, SPM system programming displays, SMDR records, and printed reports.

This feature works as follows:

- The MLX-10D, MLX-20L, and MLX-28D display telephones, and the MLX-10 nondisplay telephones are available in three separate versions, each with the factory-set buttons in the language of choice.
- The system can be programmed to operate in one of the languages, but an individual with an MLX telephone can override the system language by selecting any one of the three languages for his or her own telephone.

This section describes how to record the selected language for the system and, if desired, to set a different language for SMDR and printers.



NOTE:

If you plan to set a different language for an individual telephone, record the language selection on Form 6b as described in [Chapter 4](#), “[Features](#).”

Planning Form Instructions:

Under the Language Selection heading in the System Operating Conditions section of Form 1 (page 2):

1. To select a systemwide language, check *one* of the following: English (the factory setting), French, or Spanish.
2. To set a different language for SMDR, check *one* of the following: English (the factory setting), French, or Spanish.
3. To set a different language for printed reports, check *one* of the following: English (the factory setting), French, or Spanish.

Automatic Maintenance Busy

The factory setting for Automatic Maintenance Busy is Disable, which means that faulty lines/trunks are *not* automatically put in a maintenance-busy state.

In Key and Behind Switch modes, Automatic Maintenance Busy usually remains disabled. If you plan to group lines/trunks into pools in Hybrid/PBX mode, enable Automatic Maintenance Busy to provide optimal system performance.

For a detailed description of this feature (including considerations and feature interactions), see the *Feature Reference*.

Planning Form Instructions

Under the Automatic Maintenance Busy heading in the System Operating Conditions section of Form 1, page 2, do *either* of the following:

- To keep the factory setting (no maintenance-busy state), check Disable.
- To enable Automatic Maintenance Busy, check Enable.

Set System Date

The system date is the month, day, and year, shown on display telephones and SMDR reports. For information on SMDR, see ["System Features"](#) in [Chapter 4](#). Error reports used by authorized technicians for maintenance also show the system date and time.

These sections on the planning form remind you to set the system date when you perform the initial programming for the system.

Planning Form Instructions

Check Yes under the Set System Date heading on Form 1 as a reminder to set the current date.

Backup

Backup makes a copy of the customized system data on a translation memory card. A backup is made after each system upgrade, service technician visit, or major system reconfiguration.



NOTE:

If Automatic Backup is used, the customer must ensure that a valid PCMCIA Translation card is in the processor slot at the time of the backup. Otherwise, the Automatic Backup feature will be canceled and the customer must reset it.

Planning Form Instructions

Check Automatic if weekly or daily backup procedures are planned. Record the day and time in the blank space for weekly backups or the time of day for daily backups.

Check Manual if you plan manual backup procedures.

System Consoles

To make programming easier, use this section to summarize information about the consoles in the system.

Planning Form Instructions

Under the System Consoles heading, check the type or types of consoles:

- For Queued Call Consoles, check the QCC or QCCs box and enter the extension numbers (if known).
- For Direct-Line Consoles, check the DCL or DLCs box and enter the extension numbers (if known).

Second Dial Tone Timer

In some instances, after dialing a star code, the central office responds with a second dial tone as a prompt to enter additional digits. Once a star code is accepted by the communications system, the Second Dial Tone Timer is activated and set to the programmed value. If dialing is attempted before the Second Dial Tone Timer expires, the call is treated as though it had violated calling restrictions and is not completed.



SECURITY ALERT:

If the Second Dial Tone Timer is set to 0 ms and a caller begins dialing additional digits before the second dial tone, system restrictions may be bypassed and a restricted call may be routed. Careful administration of the Second Dial Tone Timer prevents the caller from bypassing call restrictions in this manner.

Marked System Speed Dial entries (entries that do not display) are not affected by the Second Dial Tone Timer setting. If the Central Office does not immediately supply dial tone when a star code is entered and a Marked System Speed Dial entry uses star codes, then the appropriate number of pauses (each 1.5 seconds) must be programmed in the entry following each star code.

Planning Form Instructions

Under the Second Dial Tone Timer heading, enter the desired value. Valid entries are 0–5000 ms, in increments of 200 ms. The factory setting is 0.

Applications

Several call-handling and management applications can be used with the system, including voice mail and messaging; call accounting and reporting; and call management, distribution, and reporting. This section contains instructions for noting those applications that will be used with this system.



CAUTION:

General information about these applications is contained in the Feature Reference. To ensure proper service, however, you must review the documentation provided with the application itself.

Planning Form Instructions

On Form 1 (pages 3 and 4):

1. Check the name of each application that will be connected to the system.
2. For each application name you check, you may want to include pertinent information in the Notes section. For example, you can note the version of the application installed at the customer's site.

Numbering the System

This section describes the assignment of numbers to extensions.



NOTE:

Assigning numbers to calling groups, paging groups, park zones, and remote access is described later in this book.

The process of numbering extensions consists of the following tasks:

- **Identifying Extension Jacks.** Using the placement of modules in the control unit as a guide (see the Control Unit Diagram on Form 1), determine the order in which to connect telephones and other equipment to the control unit. To do this, identify the extension jack types available by module and then match system components (for example, operator positions or telephone types) with the jacks that support them.
- **Renumbering.** If the system-assigned extension numbers are not appropriate for the customer's business, change them. The system offers two automatic numbering plans (2-digit and 3-digit numbers), as well as the option of creating a unique numbering plan with extension numbers of 1 to 4 digits. Each of these three plans allows renumbering of all or selected extensions.
- **Updating Planning Information.** Add information to Form 1 and to the floor plan as appropriate.

This section contains instructions for completing each of these tasks. The *Feature Reference* provides detailed information about system numbering and the three numbering plans.

Forms Needed

- Floor plan
- Equipment List (if available)
- Form 1, System Planning
- Form 2a, System Numbering: Extension Jacks
- Form 2b, System Numbering: Digital Adjuncts

Identifying Extension Jacks

Identifying extension jacks consists of the following tasks:

- Determining which extension jack types are available according to the types of modules in the control unit.
- Matching the telephones and other equipment to the jacks that support them, in the following order:
 - Primary operator position
 - Additional operator positions
 - CTI link port
 - Extension jack pairs (for analog multiline telephones only with Voice Announce to Busy feature and/or voice and data)
 - MLX telephones
 - Analog multiline telephones
 - Tip/ring equipment and applications

Planning Form Instructions

Before you begin, review the floor plan and Equipment List (if available) to identify the equipment and the number of each kind of connection needed, as well as to obtain other information you need to fill in the forms:

- Number, type or types, and user name and/or location of operator consoles
- Number and user name and/or location of analog multiline telephones that will use the Voice Announce to Busy feature or voice and data
- Number of non-operator MLX telephones and user names and/or locations
- Number and user name and/or location of analog multiline telephones
- Number and user name and/or location of tip/ring equipment
- Names of optional applications

Module Types and Extension Jack Types

The module type determines the type of extension jack used. For example, the 016 (T/R) module has 16 tip/ring jacks. [Table 2-2](#) lists the extension jack types and the equipment that can be connected to these jacks.

Table 2-2. Application Ports

Module	Ext. Jack Type	No. of Jacks	Used to Connect...
008 (ATL)	Analog	8	Analog multiline telephones
408 (LS-ATL)		8	TransTalk Wireless telephones (MDC, MDW)
408 GS/LS-ATL		8	Call Management System (CMS) ¹
008 MLX	Digital	8	MLX telephones with or without PassageWay Direct Connect Solution
016 MLX ²		16	CTI link
408 GS/LS-MLX		8	Desktop video endpoints and/or Group Video endpoints
408 GS/LS-ID-MLX			Digital data devices, such as an ISDN terminal adapter

Table 2-2. Application Ports — Continued

Module	Ext. Jack Type	No. of Jacks	Used to Connect...
412 LS-ID-ETR ²	ETR (all 12 ports) or Tip/ring (ports 9-12 only)	12	ETR operation: <ul style="list-style-type: none"> ■ ETR telephones ■ MLS telephones ■ TransTalk Wireless telephones (MDC, MDW) ■ Business Cordless 905
016 ETR ²	ETR (all 16 ports) or Tip/ring (ports 11-16 only)		Tip/ring operation: <ul style="list-style-type: none"> ■ Single-line telephones ■ Delay announcement devices ■ Adjuncts, such as analog modems or fax machines ■ PARTNER Door Phone ■ OPRE ■ Optional applications, such as: <ul style="list-style-type: none"> — Enhanced Service Center — Messaging 2000 — Intuity™ AUDIX VS — MERLIN Mail® Voice Messaging System¹ — AUDIX® Voice Power (IS II or III)¹

Table 2-2. Application Ports — *Continued*

Module	Ext. Jack Type	No. of Jacks	Used to Connect...
012 (T/R) 016 (T/R)	Tip/ring	12 16	Single-line telephones Delay Announcement Devices Adjuncts, such as analog modems or fax machines OPRE Optional applications, such as: <ul style="list-style-type: none"> ■ Enhanced Service Center ■ Messaging 2000 ■ Intuity™ AUDIX VS ■ MERLIN Mail® Voice Messaging System¹ ■ AUDIX® Voice Power (IS II or III)¹
008 OPT		8 ³	Tip/ring equipment in another building or off premises PARTNER Door Phone
MERLIN LEGEND Mail	Analog	0 ⁴	Provides MERLIN LEGEND Mail

1 Can no longer be ordered.

2 Release 7.0 and later systems.

3 The system uses 12 logical IDs for an 008 OPT module, even though only eight will have equipment attached to them. Do not use an 008 OPT module for applications (such as MERLIN LEGEND Mail, Messaging 2000, or Intuity AUDIX VS). Be sure to leave the extra four ports blank on Form 2a.

4 The MERLIN LEGEND Mail module has 7 dedicated internal ports, but assigns 12 total extensions.

Planning Form Instructions

Refer to the completed Control Unit Diagram (Form 1) and [Table 2-2](#) to mark the extension jack types on Form 2a:

1. For each extension module noted in the Control Unit Diagram (beginning with Slot 01), write in the type of module in the Mod. Type column of Form 2a and, after the appropriate logical ID (Log. ID) number, draw a line to indicate the end of that module.

For example, if the first module in the control unit is an 008 MLX module that has eight jacks, write 008 MLX in the Mod. Type column and draw a line after Logical ID 8.



NOTE:

If your list includes an 008 OPT module, draw a line after the twelfth logical ID, but cross off the last four logical IDs, since these jacks cannot be used to physically connect telephone equipment. The extension numbers of these logical IDs can be used, however, for applications requiring phantom extensions.

2. In the Jack Type column of Form 2a, do *one* of the following to indicate the type of each extension jack next to its logical ID:
 - If the jack is analog, check A.
 - If the jack is digital, check D.
 - If the jack is tip/ring, check T.
 - If the jack is enhanced tip/ring, check E.

You are now ready to match the system telephones and other equipment to these available jacks. After calculating touch-tone receivers, as described in the next section, begin matching equipment and jacks with Jack for Primary Operator Position, and proceed through the subsequent sections as appropriate for the system.

Touch-Tone Receivers (TTRs)

Use these guidelines for calculating the system requirements for touch-tone receivers for systems both with and without a voice messaging system (VMS).

The number of TTRs needed in a MERLIN LEGEND System should be calculated before the system is installed so that you can order the modules required to supply the TTRs. However, as the volume of calls increases and more applications are added to the system, TTRs may also need to be added. A system that exhibits one or more of the following symptoms may need more TTRs:

- Single-line telephone users do not get dial tone when they lift the handset to dial out.
- The voice messaging system fails to transfer calls.
- Calls fail to ring or go to coverage prematurely.
- Reorder tone on UDP/ARS calls using tandem tie trunks (private network only).
- Delay in MWL updates via tie trunks when tie trunks are available (private network only).

[Table 2-3](#) lists the modules that supply TTRs to the MERLIN LEGEND Communications System.

Table 2-3. Modules with Touch-Tone Receivers

Module	Number of TTRs
008 OPT	2
012 (T/R)	2
016 (T/R)	4
412 LS-ID-ETR	2
016 ETR	4
400 GS/LS/TTR	4
400 (LS)	4
800 DID	2
800 GS/LS-ID	2
MERLIN LEGEND Mail	2

A voice messaging system (VMS) requires a certain number of TTRs in addition to any system requirements for TTRs. The number of TTRs depends on the number of ports used by the voice messaging system (see [Table 2-4](#)). TTRs are also required in private networks using E&M, T1 tie, and tandem tie trunks.



NOTE:

A VMS *cannot* be directly connected to the 008 OPT module. However, the TTRs supplied by the 008 OPT module can be used by the VMS.

Table 2-4. Touch-Tone Receivers Required by Voice Messaging Systems

Number of VMS Ports	Number of TTRs Required
1	1
2	1
3	2
4	2
6	3
8	4
12 ¹	6
18	8

¹ If a 12-port MERLIN LEGEND Enhanced Service Center is used, 8 TTRs are required.

[Table 2-5](#) estimates the total number of TTRs required in the system, based on call volume and whether the system uses account codes. The call volume per hour in this table includes all calls originating from single-line telephones, calls on tie lines, incoming remote access and Direct Inward Dial (DID) calls.



NOTE:

You must consider the call traffic across a private network when estimating the number of required TTRs. This includes calls on analog tandem tie trunks and T1-emulated tandem tie trunks. In addition, if your private network includes Centralized Voice Messaging, you must consider the call traffic coming across the private network for the voice messaging system and the TTRs required for the updating of Message Waiting lights (Release 6.1 or later systems). For this updating, a TTR is required at the sending end and the receiving end. If the systems in the private network are connected by PRI trunks, no additional TTRs are needed.

Table 2-5. System Requirements for Touch-Tone Receivers

Calls/Hour	TTRs Required...	
	No Account Codes	Account Codes Used
110	2	4
180	4	6
350	4	8
420	6	8
610	6	10
710	8	10

In Release 6.0 and later systems, the use of the Prompt-Based Overflow setting, which allows callers to request overflow coverage while waiting in a calling group queue, requires TTRs for primary and secondary delay announcement devices that present the option to callers.

[Table 2-6](#) shows the TTRs required for primary delay announcement devices when using the Prompt-Based Overflow setting.

Table 2-6. TTRs Required for Primary Delay Announcement Devices

Number of Devices	Number of TTRs Required
1	1
2	2
3	3
4	4
5	4
6	5
7	5
8 or more	6

[Table 2-7](#) shows the TTRs required for secondary delay announcement devices when using the Prompt-Based Overflow setting.

Table 2-7. TTRs Required for Secondary Delay Announcement Devices

Number of Devices	Number of TTRs Required
1	1
2	1
3	1
4	2
5	2
6	2
7	3
8	3
9	3
10 or more	4

To calculate the total number of TTRs that are required by the system, do the following:

1. If the system has a VMS, use [Table 2-4](#) to find the number of TTRs required by the system to support the VMS.
2. Estimate the hourly call volume for all calls originating from single-line telephones, incoming calls (including private network tandem tie trunks) on Remote Access and DID lines, all calls on tie lines, and calls routed to the VMS. Use [Table 2-5](#) to find the system requirements for TTRs based on the estimated hourly call volume, and whether Account Codes are used.



NOTE:

You must consider the call traffic across a private network when estimating the number of required TTRs. This includes calls on analog tandem tie trunks and T1-emulated tandem tie trunks. In addition, if your private network includes Centralized Voice Messaging, you must consider the call traffic coming across the private network for the voice messaging system and the TTRs required for the updating of Message Waiting lights (Release 6.1 or later systems). For this updating, a TTR is required at the sending end and the receiving end. If the systems in the private network are connected by PRI trunks, no additional TTRs are needed.

3. Add the number of TTRs obtained in [Step 1](#) and [Step 2](#). If the Group Calling Prompt-Based Overflow setting (Release 6.0 and later systems) is not being used, go to [Step 6](#).
4. If the Group Calling Prompt-Based Overflow feature is being used, add the number of TTRs needed for the primary delay announcement devices that are assigned to those calling groups. Use [Table 2-6](#) to determine the TTR requirements for the primary delay announcement devices.
5. If applicable, add the number of TTRs needed for the secondary delay announcement devices that are assigned to calling groups using the Prompt-Based Overflow feature. Use [Table 2-7](#) to determine the TTR requirements for the secondary delay announcement devices.



NOTE:

If no announcement is used on a primary or secondary delay announcement device, no TTRs are needed.

6. Use [Table 2-3](#) for information on the number of TTRs provided by each type of module, and to determine the number of TTRs already supplied.
7. Compare the total TTRs needed to the total TTRs already supplied to determine if additional TTRs are required.
8. Add a new module if more TTRs are required.

Jack for Primary Operator Position

The factory setting for the primary operator position is the lowest extension jack on the first MLX or analog multiline telephone module. You cannot change the factory setting for the primary operator position.

The primary operator position uses two types of operator consoles:

- **Direct-Line Console (DLC)**. Can be assigned to either a digital or an analog extension jack.
- **Queued Call Console (QCC)**. Can be assigned only to a digital extension jack, and the MLX-20L is the only telephone that can be used as a QCC.

If the system includes QCCs, the primary operator position must be a QCC.

Planning Form Instructions

Mark jack assignments on Form 2a:

1. Do *either* of the following:
 - If the system uses a system programming console, proceed to Step 2.
 - If the system does not use a system programming console, skip to Step 5.
2. Obtain the logical ID of the extension jack for the system programming console by referring to the System Operating Conditions heading, Form 1 (page 2).
3. Identify the logical ID for the system programming console by writing *SPC* beside the appropriate logical ID in the Log. ID column of Form 2a.
4. Write either the name of the person who will program the system or the location of the system programming console in the Person, Location, or Function column. Then proceed to Step 5.
5. Do *either* of the following:
 - To indicate the primary QCC operator position for a system with one or more QCCs, proceed to Step 6.
 - To indicate the primary DLC operator position for a system with one or more DLCs, skip to Step 7.
6. To indicate the primary QCC operator position:
 - a. Locate the first extension jack showing a D (digital) jack type and write *QCC* beside the preprinted logical ID number.
 - b. Write the name or location of the primary QCC operator in the Person, Location, or Function column.
 - c. On Form 1 (page 2), write the extension of the QCC under System Consoles.

7. To indicate the primary DLC operator position:
 - a. Locate the first extension jack showing a jack type of D (digital) or A (analog) and write DLC beside the preprinted logical ID number.
 - b. Write the name or location of the primary DLC operator in the Person, Location, or Function column.
 - c. On Form 1 (page 2), write the extension of the DLC under System Consoles.

Proceed to the next section, "[Jacks for Additional Operator Positions.](#)"

Jacks for Additional Operator Positions

Use these instructions only if the system has more than one operator position. Otherwise, skip to the next section, "[Extension Jack Pairs for Analog Telephones.](#)"

The maximum number of operator positions is shown in [Table 2-8.](#)

Table 2-8. Maximum Number of Operator Positions

Position	Telephone	Maximum
QCC	MLX-20L	4
DLC	MLX-20L	8
DLC	MLX-28D	8
DLC	Analog multiline telephones	8

Any combination of operator positions can be assigned as long as no more than four are QCCs and the total combined number is no more than eight. For example, a system can have a combination that consists of four QCCs, two MLX DLCs, and two analog DLCs. The Call Management System (CMS) equipment connects to analog extension jacks assigned as DLC positions. You must assign two DLC positions for each CMS (maximum of two) connected to the system on analog multiline modules.

Planning Form Instructions



NOTE:

For each CMS connected to the system, you must assign two analog DLC positions. These two DLCs do *not* need to have the factory setting extension numbers but do need to be on the same module.

2 Control Unit Configuration
Numbering the System

2-25

1. On the Control Unit Diagram on Form 1, determine which extension jacks can be used as operator positions by circling the first and fifth extension jacks on digital or analog modules until you have reached the maximum number of eight positions. For Release 7.0 and later systems, the 016 MLX module has potential operator positions on the first, fifth, ninth, and thirteenth extension jacks.
2. On Form 2a, mark the extension jacks to be used as additional operator positions.
3. Do *either* of the following:
 - If the system has additional QCCs, proceed to Step 4.
 - If the system has additional DLCs, skip to Step 5.
4. For each additional QCC:
 - a. Write QCC next to the preprinted logical ID for each additional QCC position. Be sure to assign QCCs to only the first and fifth extension jacks on each digital module.
 - b. Write the name or location of each additional QCC operator in the Person, Location, or Function column.
 - c. On Form 1 (page 2), write the extension number of each additional QCC in the System Consoles box.
5. For each additional DLC:
 - a. Write DLC next to the preprinted logical ID for each additional DLC position, including DLC positions used for calling group supervisors and for the optional CMSs. Be sure to assign DLCs to only the first and fifth extension jacks on each digital or analog module.
 - b. Write the name or location of each additional DLC operator in the Person, Location, or Function column.
 - c. On Form 1 (page 2), write the extension number of each additional DLC in the System Consoles box.
6. If the system includes any Call Management Systems, write CMS in the Person, Location, or Function column next to the logical ID for the two DLC positions assigned for each CMS.

Proceed to the next section, "[Extension Jack Pairs for Analog Telephones.](#)"

Extension Jack Pairs for Analog Telephones

Use these instructions only if the system has analog multiline telephones. Otherwise, skip to the next section, "[Jacks for MLX Telephones.](#)"

MLX telephones can use the Voice Announce feature or simultaneous voice and data without requiring a second extension jack.

Analog multiline telephones require an additional extension jack to use Voice Announce when the telephone is already busy on a call or to use voice and data. The jacks must be an odd-numbered analog extension jack and the next higher (even-numbered) analog extension jack. The system assigns individual extension numbers to each of the jacks. The extension number associated with the first (odd-numbered) extension jack in the pair is the telephone's extension number. Calls cannot be placed to the extension number associated with the even-numbered extension jack. (For information about renumbering jacks, see "[System Renumbering](#)" later in this chapter.)

You can assign Voice Announce or voice and data to any of the analog multiline telephones in the system, but you cannot assign both to the same telephone.

Planning Form Instructions

On Form 2a, mark the pairs of jacks for analog multiline telephones that are to receive Voice Announce when the telephone is busy or are to receive voice and data:

1. In the Log. ID column, draw a box around the pair of extension jack numbers that you plan to assign to each analog multiline extension with either feature.
2. In the Person, Location, or Function column, next to the first (odd-numbered logical ID) number of each boxed pair, identify the extension by person or location.
3. In the Person, Location, or Function column, next to the second (even-numbered logical ID) number of each boxed pair, do *either* of the following:
 - For the Voice Announce feature, write *voice/voice*.
 - For voice and data, write *voice/data*.

Proceed to the next section, "[Jacks for MLX Telephones](#)."

Jacks for MLX Telephones

Use these instructions only if the system has non-operator MLX telephones, ISDN terminal adapters used to connect a data terminal, or digital data/video stations (such as a videoconferencing station) to assign to digital extension jacks on 008 MLX, 408 GS/LS-MLX, 408 GS/LS-ID-MLX, or 016 MLX (Release 7.0 and later systems) modules. Otherwise, skip to the next section, "[Jacks for Analog Multiline Telephones](#)." To plan connections for digital data equipment, see [Chapter 5](#), "[Data Communications](#)."

The system assigns two extensions, although only one logical ID is assigned to each digital extension jack. For MLX telephones, one extension number is automatically assigned to the MLX telephone physically connected to the digital extension jack. The second extension number is reserved for an adjunct, such as an analog modem or Delay Announcement Device, that can be connected to the

MLX telephone through a Multi-Function Module (MFM). For information about renumbering jacks, see [“System Renumbering”](#) later in this chapter.

The system automatically assigns both extension numbers whether or not the extension includes an MFM or ISDN terminal adapter. Calls can be placed to both extension numbers independently.

The MFM can operate as an interface for either a Supplemental Alert Adapter or a tip/ring device. The Supplemental Alert Adapter (SAA) setting on the MFM is used when the MFM connects an external alert such as a bell or horn. The tip/ring (T/R) setting is used when the MFM connects a tip/ring device such as an answering machine or an analog modem.



NOTES:

- The system capacity for endpoints is decreased by two whenever an MLX telephone is used.

- In Behind Switch mode, the system automatically assigns two prime lines to each port on an MLX module — one for the MLX telephone and one for the device connected to the MFM. If an MFM is not connected to an MLX telephone or the MLX port is not used, the prime line for the MFM can be removed. The prime line can then be assigned to another user.

When PRI, NI-1 BRI, or T1 Switched 56 lines/trunks are assigned to an MLX jack, digital data/video stations may use two B-channels simultaneously (2B Data) to place or receive high-speed data/video calls. For more information on planning for video applications, see [Chapter 5, “Data Communications.”](#)

Release 5.0 and later systems support the use of an MLX port as a Computer Telephony Integration (CTI) link on Hybrid/PBX mode systems. The CTI link feature allows CTI applications to interact with the MERLIN LEGEND Communications System over a local area network (LAN). The CTI link is the system’s hardware and software interface to the Lucent Technologies PassageWay Telephony Services product, which supports the Windows® 95, Windows NT, Windows 3.1, Windows 3.11 for Workgroups, Apple® Macintosh® OS and UNIX® systems platforms on the client side. CTI link circuitry connects to an MLX port on the system and to a LAN server using Novell NetWare (releases 3.12, 4.1, and 4.11) or Windows NT 4.0 Server or Workstation software (Server is recommended).

These CTI services enable a desktop computer running a certified PC application to provide computer-based features to users. Select from ports 2, 3, 4, 6, 7, or 8 on an 008 MLX, 408 GS/LS-MLX, or 408 GS/LS-ID-MLX module. In Release 7.0 and later systems, you can also select ports 2, 3, 4, 6, 7, 8, 10, 11, 12, 14, 15, or 16 on an 016 MLX module. The CTI link port cannot be the potential operator port or the console programming port.

Planning Form Instructions

Use the floor plan and Equipment List (if available) to verify the location of any video stations and all remaining MLX telephones and adjuncts connected to them.

1. On Form 2a, mark the extension jack assignments for the video stations and the remaining MLX telephones:
 - a. In the Jack Type column, make sure D is checked next to the logical ID for each digital extension jack.
 - b. In the Person, Location, or Function column, identify each video station or MLX telephone by the user's name, location, or function.
 - c. If an extension port will be a CTI link, Write *CTI Link* in the Person, Location, or Function column and Label column, and put a check mark in the CTI Link column. If this is a CTI link, skip to Step 3. Select from ports 2, 3, 4, 6, 7, or 8 on an 008 MLX, 408 GS/LS-MLX, or 408 GS/LS-ID-MLX module. In Release 7.0 and later systems, you can also select ports 2, 3, 4, 6, 7, 8, 10, 11, 12, 14, 15, or 16 on an 016 MLX module. The CTI link port cannot be the potential operator port or the console programming port.
2. Using the information from Form 2a, mark the digital extension adjuncts and video stations on Form 2b, System Numbering: Digital Adjuncts:
 - a. Do *either* of the following:
 - If the jack does not have an adjunct connected, write *None* in the Adjuncts column and skip to Step 3.
 - If an adjunct is connected to the MLX telephone, proceed to Step b.
 - b. If an adjunct is connected to the MLX telephone, enter the type of adjunct (such as *ISDN T/A*) in the Adjuncts column.
 - c. If a digital data or video station will be connected to the jack, and the equipment supports 2B Data (such as a videoconferencing system using a BRI interface or a v.35 interface and an ISDN terminal adapter that supports 2B Data), check the box in the 2B column.

NOTE:

Do not connect equipment that does not support 2B Data (such as G4 FAX, or a videoconferencing system using a v.35 interface and an ISDN terminal adapter that does not support 2B Data) to an MLX jack configured as a 2B Data port.

- d. If a digital data or video system is connected to the jack, enter the extension number in the MLX Telephone Ext. No. column.

3. Identify the type of equipment connected to the jack or the ISDN terminal adapter connected to the jack. Also, record the person, location, or function, if desired.

Proceed to the next section, "[Jacks for Analog Multiline Telephones.](#)"

Jacks for Analog Multiline Telephones

Use these instructions only if the system includes 408 (LS-ATL), 408 GS/LS-ATL, or 008 (ATL) modules. Otherwise, skip to the section, "[Jacks for Tip/Ring Equipment and Applications.](#)"

Certain features should be used differently when a General-Purpose Adapter (GPA) is connected to an analog multiline telephone and configured using the Automatic setting. These configurations include:

- A GPA connected to an answering machine and an analog multiline telephone with an Auto Answer All button programmed.
- A GPA connected to an answering machine and an analog multiline telephone programmed as a member of a calling group.



NOTE:

The answering machine may be used as either a primary or secondary Delay Announcement Device provided it hangs up when the announcement has finished.

- A GPA connected to an analog multiline telephone programmed for voice and data.



NOTE:

An MLX telephone with an MFM installed is preferred for these applications.

When these configurations are used, lift the handset before activating features that automatically turn on the speakerphone. Examples of features that automatically turn on the speakerphone are Authorization Codes, Auto Dial, Last Number Dial, and Saved Number Dial.

Assign analog extension jacks for all remaining non-operator analog multiline telephones in the system.

Planning Form Instructions

On Form 2a, mark the extension assignments for the remaining analog multiline telephones:

1. In the Jack Type column, make sure A is checked next to the logical ID for each analog extension jack.
2. In the Person, Location, or Function column, identify each analog multiline telephone by the user's name, location, or function.

Jacks for the CTI Link Application

Use these instructions only if the system has 008 MLX, 408 GS/LS-MLX, or 408 GS/LS-ID-MLX modules; or, in Release 7.0 and later systems, an 016 MLX module; and if users will be using CTI applications and a CTI Server (PassageWay Telephony Services for NetWare or CentreVu Computer-Telephony Services for Windows NT). Otherwise, skip to the next section, "[Jacks for Tip/Ring Equipment and Applications.](#)"

The CTI link allows the computer users to interact directly with the communications system and obtain access to features through the use of a computer. Once installation is completed, the CTI port does not need feature programming, but the port and extension information must be recorded so it can be used when programming the network features.

If an MLX or analog multiline telephone extension is going to have a CTI-capable program installed on the extension's worktop PC, then you need to identify both the CTI link extension (the MLX port extension that connects to the CTI Server), and the MLX or analog multiline telephone extensions that will have the CTI-capable program installed. Single-line telephones cannot make use of CTI.

If the CTI link is on the first MLX module in the system, then perform administration for the CTI link using SPM. If the CTI link is not on the first MLX module, then you can use the system programming console to do the programming.

CTI can be used only on Release 5.0 and later communications systems in Hybrid/PBX mode.

To get the Incoming Caller ID (ICLID) information, LS-ID delay must be set to On (factory setting is Off).

To use a CTI application for Call Control features (Hold, Hold retrieve, Consult, Transfer, or Conference), the call must be on an SA button.

A *monitored* extension is one that is connected to a CTI application that can handle the call; the application should be used to handle the calls. An *unmonitored* extension is not connected to a CTI application.

To receive ANI or Caller ID (if available) information for *incoming alerting calls*, calls must:

- Arrive on an SA button or be transferred by an unmonitored DLC or a QCC.
- After a call has been answered, the call may arrive at any type of facility button.

For calls that arrive on a *personal line* and are first answered by a DLC, transfers must be activated manually, using the telephone. (The CTI Client PC Transfer function only works with calls received on SA buttons.) In this situation, the following holds true:

- If a DLC is an *unmonitored* extension, and the DLC transfers a call to a *monitored* extension, it sends Caller ID/ICLID/ANI information to, and initiates a screen pop at the transfer receiver's Client PC.
- If the DLC is a *monitored* extension, the DLC receives screen pop but does not send this information to the transfer receiver.

If an *unmonitored, non-attendant* transfers a call, the recipient will not get the ANI or Caller ID information at the application, even though it may be seen on the telephone's display.

Extensions that interact with a CTI-capable program on a computer (extensions marked Computer Telephony Integrated Client PC) should not have Microphone Disable programmed.

The CTI link must be connected to an extension that is on an MLX port module, but not a module of firmware vintage 29 (see [page 1-8](#) for a complete listing of firmware and application vintage requirements). A CTI link cannot be connected to the console programming port or to a potential operator position in the first or fifth port on the 008 MLX, 408 GS/LS-MLX, and 408 GS/LS-ID-MLX modules. Potential operation positions also occur on the first, fifth, ninth, and thirteenth ports of the 016 MLX module (Release 7.0 and later systems). CTI link programming removes 2B Data programming for a port. If you want to keep a port programmed as a 2B data port, do *not* assign it as a CTI link port.

The CTI link extension must directly connect to the CTI card on the CTI Server. Adapters, MFMs, and passive bus arrangements are not supported on this port.

Planning Form Instructions

On Form 2a, mark the box under the CTI Link column for the extension that will connect the control unit to the CTI Server. The CTI link cannot be on an extension that is a potential operator (gray on the planning form), or a console programming port. If you want to keep a port programmed as a 2B data port, do *not* assign it as a CTI link port.

On form 4b or 4d, check the Yes box under Computer Telephony Integrated Client PC, or on form 5a or 5b, check the CTI PC adjunct box if a computer at the same location as the extension will have a CTI-capable program (client) installed.

Jacks for Tip/Ring Equipment and Applications

Use these instructions only if the system includes 012 (T/R), 016 (T/R), 016 ETR, 008 OPT, or 412 LS-ID-ETR modules. Otherwise, skip to the section, "[Labels](#)."

Ports 1-8 on the 412 LS-ID-ETR module are ETR ports only; the remaining 4 ports support tip/ring or ETR functionality, but not both simultaneously.

On the 016 ETR module, the first 10 ports are ETR ports only; ports 11-16 support tip/ring or ETR functionality, but not both simultaneously.

Assign the tip/ring jacks on the 012 (T/R), 016 (T/R), 016 ETR, 008 OPT, or 412 LS-ID-ETR modules to any tip/ring equipment such as single-line telephones, fax machines, analog modems, or Group Calling Delay Announcement Devices. The hardware design of the 008 OPT module includes an interface for off-premises telephones, which supplies increased gain levels and protection.

If assigning tip/ring jacks on an 016 (T/R) module, the Ringing Frequency may be set to either 20-Hz (Type A) or 25-Hz (Type E). The Ringing Frequency is programmable on each 016 (T/R) module and affects all ports on that module.

Several optional applications, if used with the system, require tip/ring jacks. These jacks are found on an 012 (T/R) or 016 (T/R) module, or on ports 9–12 of a 412 LS-ID-ETR module or ports 11–16 of a 016 ETR module when these ports are programmed for tip/ring operation. The optional applications include:

- Enhanced Service Center
- Messaging 2000
- Intuity AUDIX
- Lucent Technologies Attendant¹
- AUDIX Voice Power – Integrated Solution II (IS II)¹ or III (IS III)¹
- Integrated Voice Power Automated Attendant – IS II¹ or IS III¹

Do not use the 008 OPT module for these applications.

The system can accept up to eight application ports (extension jacks for applications) using the 012 (T/R) module. All 16 ports on the 016 (T/R) module may be used for applications.

In Release 7.0 and later systems, you can select Rotary Dial Enable for each tip/ring port. When you enable rotary dialing for a port, the port accepts both rotary dialing and touch-tone signals. If you leave the port on the factory setting of touch-tone only, no rotary dialing signals are accepted by that port. Activate Rotary Dial Enable when you connect a rotary-dial device to the communications system.

¹ Can no longer be ordered.

Table 2-9 shows, by application, the number of ports used, the number of TTRs required, and the number of additional single-line telephones that can be added to the modules. Use this table as a guideline.

Table 2-9. Application Ports

Application	Ports	TTRs Required	Maximum Additional Telephones on an 012(T/R) Module
MERLIN LEGEND Mail	2	1	N/A
	4	1	
	6	2	
Messaging 2000	4	2	2
	6	3	1
	8	4	0
	12	5	0
	16	6	0
Intuity AUDIX	4	2	2
	6	3	1
	8	4	0
	10	5	0
	12	6	0
Enhanced Service Center (ESC)	12	8	0
	16	8	0
CONVERSANT	(see NOTES below)		
MERLIN Mail ¹	2	1	3 + 1 for the modem
	4	2	2 + 1 for the modem
Lucent Technologies Attendant ¹	1	1	6
	2	1	5
	3	2	4
	4	2	3
AUDIX Voice Power ¹	2	1	6
	4	2	4
	6	3	2
	8	4	0

¹ Can no longer be ordered.



NOTES:

- On older versions of the 012 (T/R) module (apparatus codes 517C13–517J13), only four tip/ring devices connected to the module can ring simultaneously, regardless of how many jacks are open. Using more than four devices can cause the devices to operate incorrectly.
- The applications in [Table 2-9](#) do not work properly with 012 (T/R) modules manufactured for older MERLIN II systems. These applications must be connected to 016 (T/R) modules or 012 (T/R) modules with code 517C13 or higher labeled on the top of the module. Modules with code 517A13 or 517B13 can be used to connect single-line telephones only. They do not provide the disconnect signal required by answering machines and applications. Do not use the 008 OPT module for applications such as Enhanced Service Center, Messaging 2000, or Intuity AUDIX.
- When planning for CONVERSANT, refer to the documentation provided with the application and contact the SDSC (dial 1-888-297-4700 and follow the prompts to reach the CONVERSANT split) for information on TTRs and ports.

Planning Form Instructions

On Form 2a, mark the extension jack assignments on the 012 (T/R), 016 (T/R), MERLIN LEGEND Mail, and 008 OPT modules:

1. In the Jack Type column, make sure T is checked next to the logical ID for each tip/ring jack.
2. In the Person, Location, or Function column, identify each T/R device by the user's name or location and by type, such as single-line telephone, fax, modem, or Delay Announcement Device.
3. If the system includes optional applications, indicate the application on the appropriate line in the Appl column, as follows:
 - For MERLIN LEGEND Mail, write **ML Mail**.
 - For Messaging 2000, write **M2000**.
 - For Intuity AUDIX, write **Intuity**.
 - For Enhanced Service Center, write **ESC**.
 - For CONVERSANT, write **CONV**.
 - For MERLIN Mail Voice Messaging System, write **Mail**.
 - For Lucent Technologies Attendant, write **Lucent A**.
 - For AUDIX Voice Power IS II or IS III, write **AVP**.
 - For Integrated Voice Power Automated Attendant-IS II, write **IVP-AA**.
 - For no applications, write **None**.

4. If the system has Messaging 2000 or AUDIX Voice Power, also write port in the Appl column for any logical IDs that are being used for fax ports.
5. If the system is to be part of a Centralized Voice Messaging system (Release 6.1 and later systems only), check Yes under the Centralized Voice Messaging heading. Also check Yes on page 4 of the MERLIN LEGEND R6 Design Implementation Guide form located in Appendix I. If it will not be part of a Centralized Voice Messaging system, check No on both forms.



NOTE:

For more information on Centralized Voice Messaging, see the *Network Reference*.

6. For each 016 (T/R) module, if applicable, indicate the Ringing Frequency for that module. Enter 20-Hz or 25-Hz in the Ring Freq. column for all ports on the 016 (T/R) module. When configuring a system in the United States or Canada, generally the 20-Hz setting is applicable. The factory setting is 20-Hz.
7. If you are using rotary-dial equipment, check the Rot. Dial column to indicate that Rotary Dial Enable is to be activated (Release 7.0 and later systems).

Proceed to the next section, "[Labels](#)."

Labels

This section contains instructions to associate alphanumeric labels with extension numbers so that both the name of the caller and the extension number appear on display telephones.

Planning Form Instructions

On the appropriate line in the Label column on Form 2a, write the label (maximum: 7 characters) to be displayed for each telephone.

System Renumbering

The selection of a numbering plan depends on the customer's needs. Each of the systems numbering plans (2-digit, 3-digit, and Set Up Space) allows you to renumber all or selected extensions. If you do not need to renumber extensions, skip to the last section of this chapter, "[Updating Planning Information](#)."

In Release 6.0 and later systems (Hybrid/PBX mode only), the Uniform Dial Plan (UDP) allows you to choose non-local dial plan numbering to specify the numbering of extensions connected to remote systems in a private network and allow users on your system to access those extensions as if they were connected to your own system. When renumbering a system that is part of a private network, see the *Network Reference* for information.



CAUTION:

Before programming the private network ranges, set up the local dial plan. If the ranges are programmed in the network, and then 2-digit, 3-digit, or Set Up Space factory settings are used, all network ranges on that switch are erased.

Before the system is renumbered, the AUDIX Voice Power channel assignments should be deleted (through AUDIX Voice Power) for the extensions being renumbered. When the renumbering for the system is complete, AUDIX Voice Power channels for the renumbered extensions should be added.

[Figure 2-2](#) through [Figure 2-4](#) list the extension numbers according to the three numbering plans: 2-digit, 3-digit, and Set Up Space. The numbers are arranged in blocks according to the first digit. The type of equipment or feature they are assigned is shown in the block. The shaded areas of the table indicate extension numbers automatically assigned by the system. The unshaded areas indicate the extension numbers available for reassignment. Use the appropriate plan-specific instructions that follow to mark Forms 2a and 2b with extension number assignments.

For detailed information about the numbering plans (including considerations, constraints, and feature interactions that may affect selection), see the *Feature Reference*.



NOTE:

If the system includes Call Management System (CMS), it assigns extension numbers to agent splits. The CMS agent extension numbers must be two digits; therefore, use the 2-digit numbering plan for CMS. For more information, see the CMS documentation.

0						Operator Console (not flexible) 0							
1						Extensions 10–19							
2						Extensions 20–29							
3						Extensions 30–39							
4						Extensions 40–49							
5						Extensions 50–59							
6		Extensions 60–66			Extra Extensions 6700–6842		6843–6849		Extra MFMs/ Terminal Adapters 6850–6992		6993–6999		
7		Main Pool 70		MFMs/ Terminal Adapters 710–766			767–769		Calling Groups 770–791, 7920–7929			Paging Groups 793–799	
8		800¹		Trunks 801–880				Park 881–888		889²		Pools 890–899	
9						ARS Access (Hybrid/PBX Mode) / Idle Line Access 9							

1 Listed Directory Number (QCC Queue)

2 Remote Access

NOTE: "0" and "10" are the same station.

Figure 2-2. Extension Numbers for 2-Digit Numbering Plan

0						Operator Console (not flexible) 0							
1						Extensions 100–199							
2						Extensions 200–299							
3						MFMs/Terminal Adapters 300–399							
4						MFMs/Terminal Adapters 400–499							
5						500–599							
6						600–699							
7		Main Pool 70		71–76			Calling Groups 770–791, 7920–7929			Paging Groups 793–799			
8		800¹		Trunks 801–880				Park 881–888		889²		Pools 890–899	
9						ARS Access (Hybrid/PBX mode)/Idle Line Access							

1 Listed Directory Number (QCC)

2 Remote Access

NOTE: "0" and "100" are the same station.

Figure 2-3. Extension Numbers for 3-Digit Numbering Plan

0	Operator Console (not flexible) 0					
1	100-199					
2	200-299					
3	300-399					
4	400-499					
5	500-599					
6	600-699					
7	Main Pool 70	Extensions 7100-7299	MFMs/Terminal Adapters 7300-7499	7500-7699	Calling Group 770-791, 7920-7929	Paging Groups 793-799
8	800 ¹	Trunks 801-880		Park 881-888	889 ²	Pools 890-899
9	ARS Access (Hybrid/PBX mode)/Idle Line Access 9					

1 Listed Directory Number (QCC).

2 Remote Access

NOTE: "0" and "7001" are the same station.

Figure 2-4. Extension Numbers for Set Up Space Numbering Plan

Planning Form Instructions

Use [Figure 2-2](#) through [Figure 2-4](#) as you record extension number information:

1. On Form 2a and 2b, if this switch is part of a private network, check Yes under the Networked Switch heading. If the switch is not part of a private network, check No.



NOTE:

For more information, see the *Network Reference*.

2. Identify the 2-digit, 3-digit, or Set Up Space numbering system you will be using under the Factory Set column on Form 2b, by circling the name of the appropriate numbering system.
3. Do *either* of the following:
 - If you do *not* need to renumber any of the factory-set extension numbers:
 - Check the 2-Digit, 3-Digit, or Set Up Space box under the Renumber System heading on Form 2a to indicate the numbering plan you are using.
 - Skip to the next section, "[Updating Planning Information](#)."
 - If you want to renumber only a few of the extensions and there are enough numbers available for 2- and 3-digit numbering plans:
 - Check the 2-Digit, the 3-Digit, or the Set Up Space box to indicate the numbering plan you're using. *Be sure to check Selected Extension Numbers under the Renumber System heading on Form 2a, page 1.*
 - Write the new extension number or numbers in the Renumber to columns on Form 2a and Form 2b.

Proceed to the next section, "[Updating Planning Information](#)."

Updating Planning Information

On the floor plan, add the extension number beneath the symbol for each telephone and adjunct. If you are using a system programming console, go to Form 1, System Planning, in the System Operating Conditions section, and add the new extension number of the console in the space next to Ext. No.



NOTE:

The remaining columns on Form 2a (Eqpt., Label, Old Ext. No., and Wire No.) are completed by the technician during installation.

To complete the forms for lines/trunks, proceed to [Chapter 3](#), "[Lines/Trunks](#)."

Lines/Trunks

3

Overview

Planning for lines/trunks consists of the following tasks:

1. **Identifying Line/Trunk Jacks.** Use the placement of modules in the control unit (see the Control Unit Diagram on Form 1) as a guide to determine in what order to connect trunks to the control unit. To do this, identify the line/trunk jack types available by module and then match trunks and auxiliary equipment with the jacks that support them.
2. **Selecting Line/Trunk Options.** According to the requirements of the customer, choose from available options for the incoming trunks connected to the system.
3. **Assigning Lines/Trunks to User Extensions.** Assign lines/trunks to telephones and DLCs.
4. **Assigning Telephone Buttons.** Assign buttons to Hybrid/PBX mode telephones, to Key and Behind Switch mode telephones, and to DLCs.



NOTE:

If the switch is part of a private network, the following tasks must also be performed to plan for lines/trunks: Labeling the Network Trunks, PRI Switch Type (Legend-PBX or Legend-NTWK), and Switch Identifiers. See the *Network Reference* for information.

This chapter contains instructions for completing each of these tasks. You should become familiar with line/trunk types and options, as well as the requirements of the system before you attempt to perform the procedures in this chapter. It is also critical that you understand what services the local telephone company can provide.

Identifying Line/Trunk Jacks

Identifying line/trunk jacks consists of the following tasks:

1. Determining which line/trunk jack types are available according to the types of modules in the control unit.
2. Matching incoming trunks to the jacks that support them.
3. Designating jacks for auxiliary equipment (if any).

This section contains instructions for completing all of these tasks.

Forms Needed

- Form 1, System Planning
- Form 2c, System Numbering: Line/Trunk Jacks

You also need the local telephone company's line/trunk information.

Module Types and Line/Trunk Jack Types

The line/trunk jack type is determined by the type of module. [Table 3-1](#) lists the line/trunk jack types and the incoming line/trunk or auxiliary equipment that can be connected to these jacks.

Table 3-1. Line/Trunk Jack Types

Module Type	Line/Trunk Jack Type	Number of Jacks	Used to Connect
400 (LS)	Loop-start (LS)	4	Line/Trunk Types: Basic, Special Purpose (FX, WATS) Auxiliary Equipment: Music-On-Hold, Loudspeaker paging system, Maintenance Alarm
412 LS-ID-ETR ¹		4	
800 (LS)		8	
408 (LS-ATL)		4	
400 GS/LS	Ground-start/loop-start (GS/LS)	4	Line/Trunk Types: Basic, Special Purpose (FX, WATS) Auxiliary Equipment: Music-On-Hold, Loudspeaker paging system, Maintenance Alarm
800 GS/LS		8	
408 GS/LS (ATL)		4	
408 GS/LS-MLX		4	
408 GS/LS-ID-MLX ¹		4	
800 GS/LS-ID ¹		8	
800 DID (Hybrid/PBX)	DID	8	DID
800 NI-BRI	NI-1 BRI	8 (16 channels)	NI-1 BRI
400EM	Tie	4	4-wire E&M tie line
100D	DS1	1 (24 channels)	T1 T1 Switched 56 Data PRI

¹ Module designations containing "ID" indicate that the module supports Caller ID. The Caller ID functionality of the 408 GS/LS-ID-MLX module is supported only in Release 7.0 and later systems.



NOTES:

- You cannot mix T1 and Primary Rate Interface (PRI) service on the same 100D module. Any of the following AT&T Switched Network (ASN) Services can be provided through a T1 or PRI facility: Megacom[®] WATS, Megacom 800, Software Defined Network (SDN), and MultiQuest[®]. PRI also supports Call-by-Call Service Selection and some ACCUNET[®] switched digital services. T1 supports Shared Access for Switched Services (SASS) and ACCUNET Switched Digital Service (or other circuit-switched data service) at 56-kbps. Both support Dialed Number Identification Service (DNIS).
- The MERLIN LEGEND Communications System supports Centrex service with loop-start lines only. The system does *not* support a timed switchhook flash with ground-start trunks or ground-start emulation on DS1 facilities in any mode of operation (Hybrid/PBX, Key, or Behind Switch).
- The MERLIN LEGEND Communications System does not support timed switchhook flash with NI-1 BRI lines. Pressing the Recall button on a MERLIN LEGEND telephone will be ignored. If the Recall button is stored as part of an Auto Dial string, it will not be sent out over an NI-1 BRI line, or stored for Last Number Dial or Saved Number Dial when calling on an NI-1 BRI line.
- The MERLIN LEGEND Communications System does not support BRI features such as Local Area Signaling Services (LASS), central office Transfer, and other Centrex offerings.
- Trunks used for incoming caller line identification (ICLID) service should not have any equipment other than the MERLIN LEGEND line port connected to them. Connecting other equipment (such as alarms, autodialers, and so on) may result in distorted or lost ICLID data.
- Trunks assigned as either the system Music-On-Hold or External Page Port cannot be assigned as a Group Calling trunk.

LS-ID Delay Option

The LS-ID Delay option is available through the 800 GS/LS-ID, 408 GS/LS-ID-MLX, and 412 LS-ID-ETR modules and is programmed for each trunk. (Although the 408 GS/LS-ID-MLX module has been used in releases prior to Release 7.0, its Caller ID functionality is supported only in Release 7.0 and later systems. The 412 LS-ID-ETR module is available in Release 7.0 and later systems.) The LS-ID Delay option prevents applications and adjuncts from answering before the Caller ID information is processed.

Use the LS-ID Delay option only if the following conditions apply:

- If the adjunct or application cannot be programmed to answer on the second or later ring, see the documentation for the adjunct or application.
- If the first option applies (as with headsets using Auto Answer All) and line buttons receiving Caller ID cannot be programmed for Delay Ring—for example, Auto Attendants.



NOTES:

- It is recommended that trunks with the LS-ID Delay option be used as incoming trunks only.
- If no delay is programmed, the caller may hear one or two extra bursts of ringback while the person receiving the call has not yet heard a ring.
- If the option is programmed on a two-way trunk, the system will not seize a trunk from the pool for an outgoing call when that trunk is receiving an incoming call.
- Use the LS-ID Delay option if the adjunct or application does not allow line buttons to be set for Delay Ring.
- If the option is programmed on a trunk programmed as a Group Calling trunk, the system will not dispense the call to either the Group Calling queue or to any calling group member until either the LS-ID Delay timer expires or the system software is informed that ICLID information is unavailable.

Planning Form Instructions

Refer to the completed Control Unit Diagram on Form 1 to mark line/trunk jack types on Form 2c:

1. For each module with line/trunk jacks noted in the Control Unit Diagram (beginning with Slot 01), write in the type of module and its slot number in the Module Type and Slot No. column of Form 2c; after the appropriate Log. ID number, draw a line to indicate the logical IDs (and, therefore, the line/trunk jacks) that correspond to that module.

If the system has 100D (DS1) modules, keep in mind that, even though the module has only one physical jack, the 100D module supports up to 24 endpoints. Therefore, 24 logical IDs and associated line/trunk numbers are assigned to each module.

The 800 NI-BRI module supports up to 16 endpoints, therefore 16 logical IDs and associated line/trunk numbers are assigned to each 800 NI-BRI module even though the module has only eight physical jacks.

2. In the Jack Type column of Form 2c, for all modules except 100D modules, write the jack type for each logical ID. Use the codes shown in [Table 3-2](#).

Table 3-2. Codes for Line/Trunk Jacks

Jack Type Code	Line/Trunk Type
LS	Loop-start
GS/LS	Ground-start/loop-start
DID	DID
Tie	Tie
T1-GS	DS1 connectivity used to emulate GS
T1-LS	DS1 connectivity used to emulate LS
T1-Tie ¹	DS1 connectivity used to emulate tie or for digital data service
T1-DID	DS1 connectivity used to emulate DID
T1-S56	DS1 connectivity used for digital data
PRI	DS1 connectivity used for PRI service
BRI	NI-1 BRI

¹ T1 Switched 56 digital data is also available using T1-Tie trunks. See the "[Tie Trunks](#)" section later in this chapter.

3. For systems that include a 100D module, do *one* of the following in the Jack Type column:
 - If the module will emulate trunks or will be used for digital data transmission, write the appropriate jack type code (see [Table 3-2](#)) for the channels being used (for example, T1-LS, T1-TIE, or T1-S56), or write T1 if the channels are not being used at this time.
 - If the module will connect services (such as Megacom and Megacom 800), write PRI for all 24 logical IDs of PRI-type modules.

You may now match incoming trunks to the available jacks, as described in the next section.

Incoming Line/Trunk Type

Use the procedure in this section to match incoming trunks to the continuous sequence of line/trunk jacks on the control unit, beginning with the first line/trunk jack (logical ID 1).

⇒ NOTE:
(Key mode only) If the system is registered with the FCC registration number of AS59CM-7914-KF-E, and the processor module has been modified for Permanent Key mode, you can connect loop-start trunks to the GS/LS type line/trunk jacks. With the KF registration number, ground-start trunks are allowed only when the system includes DS1 connectivity dedicated as a T1 type and the channels are used to emulate ground-start trunks.

This procedure also includes instructions for assigning a label to identify the line/trunk being used.

Planning Form Instructions

1. In the Incoming Line/Trunk Type column of Form 2c, write the type of line/trunk you plan to connect to each line/trunk jack, T1 channel or BRI channel: Main No., personal line, FX (Foreign Exchange), WATS (include band), DID, or Tie. (Contact the local telephone company for line/trunk information.) Use the following guidelines:
 - Group trunks together according to type: basic loop-start or ground-start trunks, and special-purpose loop-start or ground-start trunks. (DID, PRI, T1, BRI, and tie trunks are automatically grouped according to type since they require specific types of modules.) The local telephone company supplies the information you need to identify the specific trunks connected to each line/trunk jack on each DID and tie trunk module and each channel on each 100D or 800 NI-BRI module.

- Use line/trunk jacks at the beginning of the sequence for basic ground-start and/or basic loop-start trunks. Use jacks later in the sequence for special-purpose trunks such as WATS or FX.
 - If a line/trunk, such as WATS, is only inbound or only outbound (not two-way), include that information along with the line/trunk type.
2. If the jack type shown in the Jack Type column is GS/LS, then write either *GS* or *LS* to indicate the line/trunk type in the Incoming Line/Trunk Type column. For a T1 or NI-1 BRI trunk not used at this time, write *unequipped*. For other T1 or PRI facilities, the kind of service connected (such as Megacom 800) will be filled in later.



NOTE:

In the next step, be sure the line/trunk type associated with each telephone number matches the jack type. Also, if you have 800 NI-BRI modules or have dedicated 100D module channels to emulate loop-start, ground-start, and/or tie trunks, the local telephone company will supply the telephone number associated with each of the channels on the BRI or DS1 facility.

3. In the Telephone Number or Equipment column, write the telephone number for each incoming line/trunk (as supplied by the local telephone company) on the row with the logical ID for its line/trunk jack. If you do not know the telephone number, leave the column blank and enter the information later.
4. In the Label column, write the label for each line/trunk on the appropriate line. The labels can contain up to seven characters, including capital letters, numbers, ampersands (&), dashes (-), spaces, colons (:), asterisks (*), and pound signs (#).

The remaining entries on this form are covered in "[Selecting Line/Trunk Options](#)," later in this chapter. If the system does not have auxiliary equipment (for example, Music-On-Hold or a loudspeaker paging system), skip to "[Selecting Line/Trunk Options](#)" in this chapter.

[Figure 3-1](#) shows an example of a partially completed Form 2c.

3 Lines/Trunks
 Identifying Line/Trunk Jacks

Module Type and Slot No.	Log. ID	Jack Type (LS, GS, DID, Tie, etc.)	Trunk No.	Pool Dial-Out Code†	Re-number To	Incoming Trunk Type (Main No., Personal Line, WATS, FX, etc.)	Telephone Number or Equipment	Label
008 MLX 01	1	GS	801			Basic GS	555-1200	1, LOCAL
	2	GS	802			Basic GS	555-1201	2, LOCAL
	3	GS	803			Basic GS	555-1202	3, LOCAL
	4	GS	804			Basic GS	555-1203	4, LOCAL
	5	GS	805			Basic GS	555-1204	5, LO
	6	GS	806			Basic GS	555-1205	6, l
	7	GS	807			Basic GS	555-1206	7
	8	GS	808			Basic GS	555-1207	
008 MLX 02	9	GS	809			Basic GS	555-1208	
	10	GS	810			Basic GS	555-1209	
	11	GS	811			Basic GS	555-1210	
	12	GS	812			Basic GS	555-1211	
	13	GS	813			Basic GS	555-1212	
	14	GS	814			Basic GS	555-1213	
	15	GS	815			Basic GS	555-1214	
	16	GS	816			Basic GS	555-1215	

Figure 3-1. Partially Completed System Form 2c

Jacks for Auxiliary Equipment

Use these instructions only if the system has auxiliary equipment: Music-On-Hold, a loudspeaker paging system, or a Maintenance Alarm. Otherwise, skip to the next section, "[Function Information](#)."

Only connect auxiliary equipment to loop-start or ground-start/loop-start jack types. You cannot use a line/trunk jack for auxiliary equipment on an 800 DID, 100D, 800 NI-BRI, or 400EM module.

To make it easier to add incoming trunks in the future, connect auxiliary equipment to the last line/trunk jack or jacks on the rightmost module with either LS or GS/LS line/trunk jacks.

Planning Form Instructions

1. Review the floor plan and Equipment List (if available) to confirm the auxiliary equipment to be connected.
2. At the top of Form 2c, fill in the line/trunk numbers for each type of auxiliary equipment planned:
 - For Music-On-Hold, write the line/trunk number of the line/trunk jack designated for this equipment, and identify the music source (tape player, radio, or Music-On-Hold) on the Music-On-Hold line.

NOTE:

If the system uses equipment that rebroadcasts music or other copyrighted materials, the customer may be required to obtain a copyright license from, and pay license fees to, a third party such as the American Society of Composers, Artists, and Producers (ASCAP) or Broadcast Music Incorporated (BMI). The Magic On Hold[®] system, which does not require such a license, can be purchased from a Lucent Technologies representative.

- For Loudspeaker Paging, on the appropriate row, write the line/trunk numbers (maximum of 3) of the line/trunk jack or jacks designated for the paging equipment.
- For Maintenance Alarm, on the appropriate row, write the line/trunk number of the line/trunk jack designated for the Maintenance Alarm external alert.

NOTE:

The last item, Loop-Start Reliable Disconnect, refers to a line/trunk option and is completed later in this chapter.

Function Information

If the system has a Voice Messaging System (such as Messaging 2000), you can use the Function column to indicate which service is available for those jacks. You can also use this column to indicate whether a jack connects a personal line and, therefore, has an owner.

Planning Form Instructions

In the Function column of Form 2c, do *either* of the following:

- If a jack is used for a special purpose, note the purpose. For example, if the system has Messaging 2000 with fax capability, indicate the service by writing one of the following for the appropriate jack:
 - For Automated Attendant, write **AA**.

3 Lines/Trunks

Selecting Line/Trunk Options

3-11

- For Call Answer, write **CA**.
- For Information Service, write **IS**.
- For Message Drop, write **MD**.
- For Voice Mail, write **VM**.
- For Fax Response, write **FR**.
- If a jack is used for a personal line, write the extension number of the telephone.

Proceed to the next section, "[Selecting Line/Trunk Options](#)."

Selecting Line/Trunk Options

You can select the following options for the incoming trunks connected to the system:

- Loop-Start Reliable Disconnect
- Outmode Signaling
- Toll-Call Prefix Dialing Requirements (Toll Type)
- Hold Disconnect Interval
- QCC Operator to Receive Calls (Hybrid/PBX mode only)
- QCC Queue Priority (Hybrid/PBX mode only)
- Pools
- Remote Access
- DS1 Connectivity
- Tie Trunks
- DID Trunks
- NI-1 BRI Connectivity



NOTE:

If incoming trunks are part of a private network, the Switch Identifier must also be programmed. See the *Network Reference* for information.

This section contains instructions for selecting line/trunk options for incoming trunks. In addition, because some systems outside of the US have slow dial tones from their local telephone companies, this section also includes instructions for compensating for a slow dial tone.

Forms Needed

- Form 1, System Planning

3 Lines/Trunks

Selecting Line/Trunk Options

3-12

- Form 2c, System Numbering: Line/Trunk Jacks
- Form 3a, Incoming Trunks: Remote Access
- Form 3b, Incoming Trunks: DS1 Connectivity (100D Module)
- Form 3c, Incoming Trunks: Tie
- Form 3d, Incoming Trunks: DID
- Form 3i, Incoming Trunks: BRI Options (800 NI-BRI module)

Loop-Start Reliable Disconnect

Disconnect signals on incoming calls on loop-start trunks are classified as one of the following:

- **Reliable.** A disconnect signal is sent to the system by the local telephone company shortly after a caller hangs up. Loop-start trunks must be reliable for remote call forwarding and trunk-to-trunk transfer. Also, reliable disconnect is strongly recommended for remote call transfers, and VMSs such as MERLIN LEGEND Mail.



NOTE:

If the local telephone company uses a short hold disconnect interval, do not specify a reliable disconnect signal. Also, to ensure proper voice messaging operation, and for private network systems, the system must have ground-start or loop-start trunks with reliable disconnect.

- **Unreliable.** A disconnect signal is *not* sent by the local telephone company on every call.



SECURITY ALERT:

Toll fraud can occur when loop-start lines/trunks are used with unreliable disconnect. If the calling party stays on the line after the called party hangs up, the central office will return a dial tone at the conclusion of the call enabling the caller to place another call as if it were being placed from your company.

Since the disconnect signal on most loop-start trunks is unreliable, the factory setting for the disconnect signal is Unreliable.

Before you change the setting, check with the telephone company to determine whether the disconnect signals for the loop-start trunks are reliable and to obtain the length of the hold disconnect interval.

If you select Reliable disconnect, you can set the interval after which the line/trunk is released as described in the [“Hold Disconnect Interval”](#) section later in this chapter.

Trunk-to-trunk transfer is programmed on a per-extension basis and should remain disabled even if the loop-start trunk has reliable disconnect. See the [“Trunk-to-Trunk Transfer”](#) section in [Chapter 4](#).

Planning Form Instructions

At the top of Form 2c, under the Loop-Start Reliable Disconnect heading, choose one of the following:

- If the loop-start trunks have an unreliable disconnect signal, check the No box (the factory setting).
- If the loop-start trunks have a reliable disconnect signal, check Yes.

Outmode Signaling

The system is factory-set to generate touch-tone signals when users dial outside calls. Identify any rotary-dial trunks that are connected to the system so that rotary-dial signals can be used for these trunks.



NOTE:

Touch-tone, single-line telephone users cannot make calls using rotary-dial trunks unless their telephones allow them to switch between touch tones and rotary dial pulses. Check with the local or long-distance telephone company to determine which, if any, trunks connected to the system are rotary-dial trunks.

Planning Form Instructions

In the Outmode Signaling column on Form 2c, do *one* of the following:

- For touch-tone trunks (factory setting), put a check in the TT column.
- For rotary-dial trunks, put a check in the R column.

Toll Type Prefix Required

Toll Type allows the system to classify calls as either local or toll, based on the number dialed by the user. Normally, people have to dial a toll-call prefix (1 or 0) before dialing the area code and telephone number for a toll call. In some areas, this is not necessary; dialing a prefix depends on local telephone company requirements and the type of line/trunk used.

Find out from the local telephone company which trunks require a toll-call prefix. This information is used by the system when a toll call is placed by an extension on ground-start or loop-start trunks.

For reliable toll restriction, telephone company trunks must require 1 or 0 for toll calls. Also, the Toll Type feature does *not* apply to tie trunks.

Planning Form Instructions

On Form 2c, in the Toll Type Prefix Required for LD column, check Yes next to any trunks on which people need to dial a prefix when placing toll calls.

Hold Disconnect Interval

This option allows you to set the number of milliseconds (ms) before the line/trunk is released when a caller on hold hangs up and abandons the call. Local telephone companies use either a long (450 ms) or short (50 ms) interval. The factory setting for the system is the long interval, since it is the interval used by most telephone companies.

Check with the local telephone company for the disconnect interval used.

If the local telephone company uses the short interval, you must change the factory setting. If you do not change the setting, when a caller waiting on hold hangs up, the line/trunk is not released.

Planning Form Instructions

In the Hold Disc. Interval column on Form 2c, do *either* of the following:

- To change to a short hold disconnect interval (50 ms), put a check in the Short column.



NOTE:

If the local telephone company uses a short hold disconnect interval, be sure you have checked No for Loop-Start Reliable Disconnect, as described earlier in this section.

- To keep the factory setting, a long hold disconnect interval (450 ms), put a check in the Long column.

QCC Operator to Receive Calls (Hybrid/PBX Mode Only)

Use these instructions only if the system has one or more QCCs. Otherwise, skip to "[Remote Access](#)."

Assigning the QCC operator to receive calls on a line/trunk determines whether incoming calls on the line/trunk ring into the QCC queue and which QCC operator position answers the calls. This applies to Hybrid/PBX mode only.

⇒ NOTES:

- If an operator presses the programmed Backup On (or Position Busy) button on the console, any incoming calls are directed to other operator positions (regardless of whether they normally receive such calls) or to the programmed backup extension number. For more information, see "[Position-Busy Backup](#)" in the "[Queued Call Console \(Hybrid/PBX Mode Only\)](#)" section of [Chapter 4](#).
- Trunks assigned to ring into the QCC queue cannot be assigned as Group Calling lines/pools.

Planning Form Instructions

For each ground-start, loop-start, and automatic-in tie line/trunk on Form 2c, write *one* of the following in the QCC Operator to Receive Calls column:

- If you do not want the calls received on the line/trunk to ring into the QCC queue, write No (factory setting).
- If you want all QCC operators to receive incoming calls on a line/trunk, write All.
- If you want to specify one or more QCC operators to receive incoming calls on a line/trunk, write any combination of the extension numbers for up to four operator positions.

If you wrote All, or specified extension numbers in this procedure, then proceed to the next section, "[QCC Queue Priority Level \(Hybrid/PBX Mode Only\)](#)." Otherwise, skip to the following section, "[Pools \(Hybrid/PBX Mode Only\)](#)."

QCC Queue Priority Level (Hybrid/ PBX Mode Only)

The QCC queue priority determines the order in which calls on each line/trunk are sent to QCC operator positions. You set the priority for each individual line/trunk.

Considerations to be used in deciding the priority level are discussed in the description of Queued Call Consoles in the *Feature Reference*.

Since incoming calls on DID and non-automatic-in tie trunks route to specific extension numbers, you cannot assign a QCC queue priority for these types of trunks. Also, QCC queue priority cannot be assigned to private network tandem trunk types (Legend-PBX or Legend-NTWK). However, calls received can be directed to the Listed Directory Number (LDN) which has queue priority set.

Planning Form Instructions

On Form 2c, for each line/trunk with All or an extension number in the QCC Operator to Receive Calls column, write the priority level (1 to 7) in the QCC Queue Priority Level column for each line/trunk used for incoming calls. (A value of 1 indicates the highest priority; a value of 7 indicates the lowest. The factory-set priority for calls received on all trunks programmed to ring in the queue is 4.)

Pools (Hybrid/PBX Mode Only)

The system can have up to 11 pools with factory-set dial-out codes of 70 and 890 through 899. When the system is set up, pools are assigned automatically (see the *Feature Reference*). If you want any lines/trunks grouped in a pool, you must manually assign each line/trunk to the pool of your choice. Use the instructions in this section.



NOTES:

- Pools can be assigned to calling groups and all trunks within the pool are directed to members of the calling group. Individual trunks within a pool cannot be assigned to calling groups.
- If the pool contains any dial-in trunks (such as DID trunks), the pool cannot be assigned to a calling group. Also, pools with private network tandem trunks should not be assigned to calling groups.

Decide whether to change the dial-out codes. Apply the same considerations as you do for reassigning extension numbers.

Planning Form Instructions

1. Use the following guidelines to determine which trunks to group into pools:
 - Each pool should contain trunks of the same type (basic, WATS, FX, or tie). Ground-start and loop-start trunks of the same type (for example, WATS or FX) can be mixed in the same pool.
 - Do not mix different calling areas of WATS or FX trunks to different cities or include both inbound-only and outbound-only trunks within the same pool. DID trunks and/or trunks used for auxiliary equipment cannot be grouped in pools. T1 Switched 56 data lines should not be mixed with trunks used for voice calls. If you plan to assign Pool buttons on telephones, do not group dial-in-only tie trunks in pools.
 - In typical pooled systems, all the trunks are grouped in pools except those mentioned previously, single special-purpose trunks, and any basic trunks that are needed as personal lines assigned to a button on a telephone.
 - Group the trunks for the main pool first. This should be the local trunks capable of accepting 411, 911, and so on. If your system includes ground-start basic trunks, reassign them from the dial-890 extension pool to the main pool. After these trunks are assigned to the main pool, decide how to arrange the rest of the trunks in the remaining pools. For private network systems, refer to the *Network Reference* for additional information.
2. Indicate the dial-out code in the Pool/Dial-Out Code column on Form 2c by doing *either* of the following:
 - To keep the factory set dial-out code, write the code.
 - To change the factory-set dial-out code:
 - Write the new number in the Renumber to column.
 - On Form 2d, System Numbering: Special Renumbers, write the new number in the Renumber to column of the Pools section of the form.
3. On Form 2c, use the Function column to identify different calling areas of WATS trunks and different destinations of FX trunks.
4. Proceed to the next section, "[Remote Access](#)."

Remote Access



SECURITY ALERT:

The Remote Access feature of your system, if you choose to use it, permits off-premises callers to access the system from a remote telephone by using an 800 number or a 7- or 10-digit telephone number. The system returns an

acknowledgment signaling the user to enter his or her barrier code, which is selected and programmed by the system manager. After the barrier code is accepted, the system returns dial tone to the user. If you do not program specific egress restrictions, the user will be able to place any call normally dialed from a telephone associated with the system. Such an off-premises network call is originated at, and will be billed from, the system location.

The Remote Access feature, as designed, helps the customer, through proper programming, to minimize the ability of unauthorized persons to gain access to the network. Most commonly, telephone numbers and codes are compromised when overheard in a public location, through theft of a wallet or purse containing access information, or through carelessness (writing codes on a piece of paper and improperly discarding it). Additionally, hackers may use a computer to dial an access code and then publish the information to other hackers.

(See [Appendix A](#), "[Customer Support Information](#)," for more information about security.)

Use these instructions only if remote users need access to the system. Systems that are part of a private network need to use these instructions to modify Remote Access so that users can access remote trunks. Otherwise, skip to the next section, "[DS1 Connectivity \(100D Module\)](#)."

The Remote Access feature allows people to use the system from a remote location. It also allows remote system programming and maintenance by a qualified technician.

You can assign remote access to any incoming line/trunk connected to the system except T1 Switched 56 data facilities, DID and dial-in tie trunks, and private network tandem trunks. (For DID, the routing digits supplied by the central office must match the remote access code.)

This section contains instructions for:

- Renumbering the remote access code from the factory setting
- Allowing access to the Automatic Callback feature
- Designating trunks for remote access
- Specifying shared or dedicated access
- Assigning barrier codes and class-of-restriction for security
- Allowing access to private network tandem trunks

For detailed information about these options, see the *Feature Reference*.

You may want to assign remote access to only a few trunks and increase the number later if more are needed.



NOTES:

- If you want to allow remote access on DID trunks, the routing digits supplied by the central office must match the factory-set remote access code (889) or the remote access code assigned to the system in the following procedure.
- Trunks programmed for both remote access and Group Calling will receive remote access treatment only.
- Remote access callers may not log in to a calling group but may call the calling group by dialing the group access number.
- Private network calls may use the Remote Access feature if the remote access code is included in the non-local dial plan.

Planning Form Instructions

1. See "[Numbering the System](#)" in [Chapter 2](#). Review the numbers available in the numbering plan you have selected. Before you begin planning remote access, to assure that TTRs are available, check the Control Unit Diagram on Form 1 to verify that one or more of the following types of modules are present: 400 (LS), 400 GS/LS/TTR, 008 OPT, 800 DID (Hybrid/PBX mode only), 800 GS/LS-ID, 012 (T/R), or 016 (T/R) module; or, in Release 7.0 and later systems, the 412 LS-ID-ETR or 016 ETR module.
2. Under the DID and Private Network Tie Trunks heading at the top of Form 3a, Incoming Trunks: Remote Access, do *either* of the following:
 - To keep the factory-set access code, check Remote Access Code: 889 and proceed to Step 3.
 - To change the factory-set access code:
 - Check Renumber to and write the new number on the line provided.
 - On Form 2d, System Numbering: Special Renumbers, write the new number in the Renumber to column of the Remote Access Code section at the bottom of the form. Proceed to Step 3.
3. Under the Automatic Callback heading at the top of Form 3a, check *either* of the following:
 - If you do not want remote callers to use the Automatic Callback feature, check Disable (factory setting).
 - To allow remote callers to use this feature, check Enable.



NOTE:

Private network calls to Remote Access cannot use the Automatic Callback feature.

4. Under the Barrier Required for Private Network Tie Trunks heading, check *either* of the following:
 - If any of the following conditions apply, check Yes.
 - You plan to assign barrier codes to these trunks.
 - Private network Tie calls are allowed access to PSTN trunks using ARS.
 - Private network Tie calls pass through the system (use Tandem switching).
 - If no barrier codes are planned for these trunks, check No.



SECURITY ALERT:

To help prevent toll fraud, barrier codes should always be assigned. The barrier codes should also be the maximum length allowed.

5. Under the Barrier Codes Required for Non-Tie Trunks (DID, PRI private network calls, and PRI Dial-Plan routing) heading, check *one* of the following:
 - If any of the following conditions apply, check Yes.
 - You plan to assign barrier codes to these trunks.
 - Private network PRI calls are allowed access to PSTN trunks using ARS.
 - Private network PRI calls pass through the system (use Tandem switching).
 - If no barrier codes are planned for these trunks, check No.



SECURITY ALERT:

To help prevent toll fraud, barrier codes should always be assigned. The barrier codes should also be the maximum length allowed.

6. Remote access should not be assigned to DID trunks and private network tandem trunks that are used for incoming customer calls. However, for all trunks to which you are assigning remote access:
 - a. Transfer the information from Form 2c, System Numbering: Line/Trunk Jacks to Form 3a:
 1. Write the logical ID and line/trunk number in the applicable columns.
 2. Check either the DID or Priv. Net. Tie Trunk column or the Non-Tie Trunk column.

3. Complete the Line/Trunk Type and Description column. Include the different calling areas of WATS trunks and different destinations of FX trunks. If a private network trunk, write **Network**.
 - b. For each line/trunk, check the Dedicated column (to indicate that it is always used for remote access) or the Shared column (to indicate that it is used for remote access when the system is in Night Service operation). Do not check either column for private network trunks.
7. For Class-of-Restriction without Barrier Codes on Form 3a (page 3), complete the DID and Private Network Tie Trunks and Non-Tie Trunks sections as follows:
- a. Under the Network Calls heading, check one of the boxes using the following information:
 - If the switch is not part of a private network, check None.
 - If the switch is part of a private network, and tandem calls will pass through this system, check Tandem.
 - If the switch is part of a private network, and network calls will be allowed to access PSTN trunks, check ARS.

 **NOTE:**

If Tandem or ARS is selected under Network Calls, the Restriction should be set to Unrestricted. For additional information on private networks, see the *Network Reference*.

- b. For Restriction, check one of the following three boxes: Unrestricted, Outward Restrict (to keep the factory setting), or Toll Restrict.



SECURITY ALERT:

It is recommended that Outward Restrict be set at all times; otherwise, toll fraud can occur. If the switch is part of a private network and restrictions need to be changed from Outward Restricted, barrier codes should be required.

- c. Under the Disallowed List Access heading, check the box if you plan to assign disallowed lists.



NOTE:

Instructions for filling in the ARS Restriction Level and Disallowed List numbers are included in [Chapter 4](#), "[Features](#)."

8. Form 3a (page 4) identifies programming information for four barrier codes. If more barrier codes are planned, make the appropriate number of copies of Form 3a (page 4). A maximum of 16 barrier codes is allowed.



SECURITY ALERT:

Barrier codes of at least 11 digits should be assigned to help prevent toll fraud.

For Class-of-Restriction with Barrier Codes on Form 3a (page 4), do the following for each barrier code:

- a. Write the barrier code number in the space provided, numbering them sequentially beginning with 1.
- b. Write the 4- to 11-digit barrier code in the Digits space. The star is added to the end of the barrier code. For security reasons, you may want to record the code elsewhere.
- c. For Restriction, check one of the following three boxes: Unrestricted, Outward Restrict (to keep the factory setting), or Toll Restrict.
- d. Under the Disallowed List Access headings, check the boxes if you plan to assign disallowed lists.



NOTE:

Instructions for filling in the ARS Restriction Level and Disallowed List numbers are included in [Chapter 4](#), "[Features](#)."

Proceed to the next section, "[DS1 Connectivity \(100D Module\)](#)."

DS1 Connectivity (100D Module)

Use these instructions only if the system has a 100D module. Otherwise, skip to [“Tie Trunks.”](#)

Digital Signal 1 (DS1) connectivity involves the transmission of digital signals in DS1 format. The interface that enables the system to allow DS1 connections is the 100D module. The system can have up to three 100D modules. Each 100D module supports up to 24 logical endpoints (IDs) or ports (one for each channel), even though the module has only one jack.

The 100D module can be configured to operate with either of the following types of service:

- **T1** (factory setting). To transmit and receive voice and analog data and, with T1 Switched 56 service, digital data.
- **PRI** (Primary Rate Interface). To transmit and receive voice, analog, and digital data.

To ensure the proper protocol between both ends of the DS1 connection, the following options should be set for both types of service:

- Type of Service
- Frame Format
- Suppression (Line Code)
- Signaling mode
- Line Compensation
- Clock Synchronization
- Channel Service Unit (CSU) setting

Additional settings must be entered for both services, especially for PRI and T1 Switched 56 service. Appropriate settings are determined by the transmission facility to which the module is connected and/or is supplied by the service provider. This section contains instructions for both T1 and PRI services.



NOTE:

PRI service for Release 2.0 through Release 4.1 systems requires that the service provider's switching equipment be either a 4ESS Generic 13 through 16, 5ESS Generic 6, or a 5ESS serving the FTS2000 (federal government only) network. PRI service for a Release 1.0 or Release 1.1 system requires that the switching equipment be a 4ESS Generic 13 through Generic 16 switch. Release 4.2 and later systems require that the service provider's switching equipment may be any of the above systems, or a DMS-100, DMS-250, or DEX600E.

If DS1s are to be used for private networks, see the *Network Reference* before you begin this section and as you work through these instructions.

Planning Form Instructions

On Form 2c, System Numbering: Line/Trunk Jacks:

1. For all trunks listed as "PRI" in the Jack Type column:



NOTE:

You cannot use Channel 24 for services.

- a. Write the kind of service to be connected to each channel in the Incoming Line/Trunk Type column. If the PRI channel is being used in a private network, write NTWK and the switch identifier in this column.
 - b. Write *unequipped* in the Incoming Line/Trunk Type column for any channel not used at this time.
2. For all trunks listed as T1-Tie that do not show an *unequipped* entry in the Incoming Line/Trunk Type column, write the kind of service connected to each channel in the Incoming Line/Trunk Type column.



NOTE:

If you use common-channel signaling, you cannot use Channel 24 and program the module for tie-trunk emulation.

3. Select settings for T1 and T1 Switched 56 (see the next section, "[T1 Service](#)"). For T1 Switched 56 service, you must also complete the "[T1 Switched 56 – Network](#)" section.

T1 Service

T1 service allows the emulation of different analog lines. You can also order services, such as Megacom 800, over the channels. The capacity, however, is limited to voice calls and data calls using a modem. In addition, beginning with Release 4.0 of the MERLIN LEGEND Communications System, T1 supports ACCUNET Switched Digital Service (or other circuit-switched data service) at 56-kbps when the T1 channel or T1-Tie trunk is configured as T1 Switched 56. Release 6.0 and later systems allow T1 service to provide tandem PRI service in a private network.

The planning form instructions below apply to both T1 and T1 Switched 56 service except where noted. If you are configuring channels for T1 Switched 56 service, complete these instructions then proceed to the [“T1 Switched 56 – Network”](#) section that immediately follows. If configuring T1-Tie trunks for T1 Switched 56 service, proceed to the [“Tie Trunks”](#) section after completing these instructions. If you are planning to use T1 service as PRI trunks in a private network, check the PRI box under Type of Service on Form 3b (page 1). See the *Network Reference* for more information regarding configuration for use in a private network.

Planning Form Instructions

Fill in the following on Form 3b (page 1), Incoming Trunks: DS1 Connectivity (100D Module), for each 100D module in the system:

1. In the Module Slot No. space, write the number of the control unit slot that contains the module (see the Control Unit Diagram on Form 1).



NOTE:

If more than one 100D module is used, complete the first box, Module 1, to show the options assigned to the 100D module in the lowest number control unit slot. Use the second box for the second lowest-numbered slot, and the last box for the highest-numbered slot.

2. Under Type of Service, check T1 (the factory-setting).



NOTES:

- For T1 or T1 Switched 56 service, the T1 box must be checked on the form. (If you leave this blank, and T1 is not specified during programming, the 100D module will not be programmed.)
- Steps 3, 4, 5, and 6 must match the service provider settings. Check with the provider if necessary. See [“Obtaining Telephone Company Information,”](#) in [Chapter 1](#), for more information.

3. In the table under the T1 Trunks heading, write the channel number or numbers for each trunk type and/or, for Tie or All Tie, check the Tie-PBX, Toll, or S56 boxes.
4. Under the Frame Format heading, do *either* of the following:
 - To retain the factory setting, check D4 Compatible.
 - To change the factory setting, check Extended Superframe (ESF).
5. Under the Suppression (Line Code) heading, do *either* of the following:
 - To retain the factory setting, check AMI-ZCS.
 - To change the factory setting, check B8ZS.
6. For T1 operation only, under the Signaling Mode heading, for all boxes that describe T1 modules, do *either* of the following:
 - To retain the factory setting of robbed-bit signaling, check Robbed-Bit Signaling (RBS).
 - To change the factory setting to common-channel signaling, check Common-Channel Signaling (CCS).

 NOTE:

CCS is not an option with T1 when you use a 100D module of apparatus code 517M15 or later. CCS is used primarily for an earlier "AT&T Proprietary" connection between a MERLIN LEGEND Communications System and a DEFINITY[®] or System 25[®] system. If CCS is required, a prior release of the module is needed. A 100D module of apparatus code 517M15 or later does not work in the following situations:

- If a 64-kbps clear data channel is required between connected systems *and* PRI is not an option.
- If the customer is replacing a 100D module programmed as CCS, either an older 100D module that supports CCS with T1 must be used, or PRI must be programmed on both connected systems.

7. Under the Line Compensation heading:
 - a. Fill in the approximate distance (number of cable feet) between the 100D module and its channel service unit (CSU) or other far-end connection in the space provided next to Cable Feet.
 - b. Use [Table 3-3](#) to select the Line Compensation setting needed. (The factory setting is 1.)

Table 3-3. Line Compensation Settings

Setting	dB Loss	Cable Feet ¹
1 (factory setting)	-0.6	0–133
2	-1.2	133–266
3	-1.8	266–399
4	-2.4	399–533
5	-3.0	533–655

¹ Based on 22-gauge cable.

8. If the system includes both 800 NI-BRI and 100D modules, clock synchronization planning should be completed at the same time. There is only one primary/secondary/tertiary clock for both 800 NI-BRI modules and 100D modules, with the same system programming screens used for both types.

Plan your clock source administration to minimize the need for clock switching, which is known to cause noise on active calls.



NOTE:

The following information is for planning clock synchronization in systems that are not part of a private network. For planning clock synchronization in a private network configuration, see the *Network Reference*.

Under Priority in the Clock Synchronization section, do *either* of the following:

- If installing only one 100D module:
 - To keep the factory setting, check Primary (that is, this module provides synchronization for the system).
 - If the synchronization source is other than through the 100D module, check None.
- If installing more than one 100D module, decide which module, if any, provides the primary synchronization:
 - If Module 1 provides clock synchronization, check Primary in the first box (the factory setting).
 - If Module 2 (or Module 3) provides clock synchronization, check Primary in the box that describes that 100D module.

- If the synchronization source is other than through a 100D module, check None.
9. If assigning backup synchronization:
 - a. In the box that describes the 100D module providing secondary synchronization, check Secondary.
 - b. In the box that describes the 100D module providing tertiary back up, check Tertiary.
 10. Under the Source subheading in each box, do *either* of the following:
 - To retain the factory setting, check Loop (that is, the system uses the clock of the far-end connection).
 - To change the setting, check Local (that is, the clock is free-running).

 **NOTE:**

The MERLIN LEGEND System must be set to Loop if the clock Source is coming from the network. The Local setting is generated from the MERLIN LEGEND System and must be used whenever connecting two MERLIN LEGEND Systems or a MERLIN LEGEND System and a DEFINITY System (Tie trunk). In a Tie trunk configuration, one system *must* have the clock Source set to Local and the other *must* be set to Loop.

11. Under the Activation subheading in each box, do *either* of the following:
 - If loop clock synchronization is taking place, check Active (factory setting).
 - If the clock is free-running, check Not Active.

 **NOTE:**

Normally, the primary synchronization source is set to Active and other modules are set to Not Active.

12. If incoming ground-start or loop-start trunks are to be emulated, then record the CSU setting under the Channel Service Unit heading by doing *either* of the following:
 - To retain the factory setting, check Foreign Exchange.
 - To change the factory setting, check Special Access.

To set up T1 channels for T1 Switched 56 service, continue with the next section. To set up T1 Switched 56 service on T1-Tie trunks, proceed to the section entitled "[Tie Trunks](#)." To set up a 100D module for PRI service, proceed to the section entitled, "[Planning Form Instructions](#)."

T1 Switched 56 – Network

Use these instructions only if channels on a 100D module are to be programmed as T1 Switched 56 channels. The instructions provided in the [“T1 Service”](#) section must be completed first.

T1 Switched 56 service provides high speed digital data services (up to 56-kbps per channel) to the network as well as digital Tie trunk services. This allows you to use your T1 facilities for basic digital data and file transfer needs, as well as for more sophisticated personal and/or group videoconferencing.



NOTES:

- T1 Switched 56 service is supported only in Hybrid/PBX or Key mode.

- Incoming data calls that attempt to route to busy data endpoints, unassigned Dial Plan numbers, or ports that are not equipped with data endpoints will not be connected.

This section contains instructions for configuring those T1 Switched 56 options that apply to the T1 network interface. For information specific to digital Tie trunk planning, refer to the [“Tie Trunks”](#) section of this chapter.

The following options are covered in this section:

- Direction
- Incoming and Outgoing Signaling Type
- Incoming and Outgoing Signaling Mode
- Dial Plan Routing options (incoming services)

After completing the procedure for filling in the module information on Form 3b, pages 1 and 2, continue to the next section to fill in T1 Switched 56 options.

Planning Form Instructions

On Form 3b (page 11), T1 Switched 56 Options, for each T1 channel programmed for T1 Switched 56 service:

1. Select the Channel Direction.
 - Select either Incoming, Outgoing, or Two Way. The factory setting is Two Way.

2. Select both the Incoming and Outgoing Signaling Mode.
 - Select either Touch-tone or Rotary. The factory setting is Touch-tone.
3. Select both the Incoming and Outgoing Signaling Type.
 - Select either Wink, Auto, or Delay. The factory setting is Wink. The Incoming Signaling Type selected will determine the Incoming Routing Method:
 - If the Incoming Signaling Type is set to Auto, the Incoming Routing Method is Line Appearance Routing. Incoming data calls are typically terminated at a data extension/endpoint that has a personal line appearance. The 1B data call may also terminate at a data extension/endpoint in a calling group.
 - If the Incoming Signaling Type is set to Wink or Delay, the Incoming Routing Method is Dial Plan Routing. Incoming data calls are routed by dial plan and may terminate to an SA button on any data extension within the system.

If the switch is part of a private network, data calls can be routed to another switch in the network. T1-emulated tie lines need to be assigned to a pool and programmed to a route. The route must be marked as Data Only.
4. If the Incoming Signaling Type is programmed as Wink or Delay and incoming data calls are routed by dial plan, you may have to manipulate the incoming digits by deleting or adding digits. This is because, in many cases, the digits that are sent by the service provider may not match the programmed dial plan. See the *Network Reference* for more information.

Enter the following Dial Plan Routing options:

- **Expected Number of Digits.** Check the expected number of digits (1–4). The factory setting is 3.
- **Number of Digits to Delete.** Check the number of digits to delete (0–4) in order to match the Dial Plan. The factory setting is 0.
- **Specific Digits to Add.** Enter the specific digits to add (1–9999) to the collected digits in order to determine a routing pattern. If no digits are to be added, check 0. The factory setting is 0.

PRI Service

Use these instructions only if the type of service on a 100D module is PRI. Otherwise, skip to the section, "[Tie Trunks](#)."



NOTE:

For private PRI network trunks, see the "[T1 Service](#)" section earlier in this chapter and the *Network Reference*. Do not use the PSTN PRI service.

PRI is a standard access arrangement of Integrated Services Digital Network (ISDN) service that may be used to connect the system to another switch over a DS1 facility.

This section contains instructions for recording decisions about the following options for each PRI facility:

- B-channel groups
- PRI services (incoming and outgoing) according to B-channel group
- Line Appearance Routing (incoming services)
- Dial Plan Routing (incoming services; Hybrid/PBX mode only)
- Outgoing Tables (Network Selection Table, Special Services Table, and Call-by-Call Service Table)
- Telephone Number to Send Station Identification or Automatic Numbering Information (SID-ANI)
- Test Telephone Number or Numbers
- Timers and Counters
- Terminal Equipment Identifier (TEI)

After completing the procedure for filling in the module information on Form 3b, pages 1 and 2, continue to the next section to fill in PRI options.



NOTES:

- The PRI service type must be selected before entering the PRI information during system programming.
- Because of the complexity of the timer, counter, and terminal equipment identifier information, the factory settings should rarely be changed. Incorrect settings can have an adverse affect on the operation of PRI facilities.
- If there is more than one 100D module set up for PRI service or you have more than eight B-channel groups assigned to a module, make copies of Form 3b (page 4) as necessary.

Module Information

Use the procedure in this section to fill in module information on pages 1 and 2 of Form 3b, Incoming Trunks: DS1 Connectivity (100D Module). Then proceed to the next section.

Planning Form Instructions

On Form 3b (page 1), Incoming Trunks: DS1 Connectivity (100D Module), for each 100D module with PRI service:

3 Lines/Trunks

Selecting Line/Trunk Options

3-32

1. In the module Slot No. space, write the number of the control unit slot that contains the module (see the Control Unit Diagram on Form 1).



NOTE:

If more than one 100D module is used, complete the first box, Module 1, to show the options assigned to the 100D module in the lowest-numbered control unit slot. Use the second box for the second lowest-numbered slot and the last box for the highest-numbered slot.

2. Under the Type of Service heading, check PRI. (During programming, PRI must be selected here *before* the PRI options information is entered. When it is selected, the system restarts.)
3. Under the Switch Type (PRI Service Only) heading, check the PRI switch type. If the switch is part of a private network, check either Legend-PBX or Legend-NTWK.



NOTE:

If the switch is part of a private network and is connected to a DEFINITY switch, select Legend-PBX. If the switch is connected to another MERLIN LEGEND System, one switch must be configured as Legend-PBX and the other is configured as Legend-NTWK. See the *Network Reference* for more information.

4. Under the Frame Format heading, change the factory setting by checking the Extended Superframe (ESF) box.
5. Under the Suppression (Line Code) heading, change the factory setting by checking the B8ZS box.
6. Under the Signaling Mode heading, check Common-Channel Signaling (CCS).



NOTE:

CCS is automatically assigned when PRI is selected. Also, Channel 24 cannot be used for voice or data transmissions.

7. Under the Line Compensation heading:
 - a. Fill in the approximate distance (number of cable feet) between the 100D module and its CSU or other far-end connection in the space before Cable Feet.

- b. Use [Table 3-4](#) to select the line compensation setting needed. (The factory setting is 1.)

Table 3-4. Line Compensation Settings

Setting	dB Loss	Cable Feet ¹
1 (factory setting)	-0.6	0–133
2	-1.2	133–266
3	-1.8	266–399
4	-2.4	399–533
5	-3.0	533–655

¹ Based on 22-gauge cable.

- 8. If the system includes both 800 NI-BRI and 100D modules, clock synchronization planning should be completed at the same time. There is only one primary/secondary/tertiary clock for both 800 NI-BRI modules and 100D modules, with the same system programming screens used for both types.

If the switch is part of a private network, clock synchronization needs to be coordinated for the entire network. See the *Network Reference* for information.

Plan your clock source administration to minimize the need for clock switching, which is known to cause noise on active calls.

Under Priority in the Clock Synchronization section, do *either* of the following:

- If installing only one 100D module:
 - To keep the factory setting, check Primary (that is, this module provides synchronization for the system).
 - If the synchronization source is other than through the 100D module, check None.
- If installing more than one 100D module, decide which module, if any, provides the primary synchronization:
 - If Module 1 provides clock synchronization, check Primary in the first box (the factory setting).
 - If Module 2 (or Module 3) provides clock synchronization, check Primary in the box that describes that 100D module.
 - If the synchronization source is other than through a 100D module, check None.

9. If assigning backup synchronization:
 - a. In the box that describes the 100D module providing secondary synchronization, check Secondary.
 - b. In the box that describes the 100D module providing tertiary back up, check Tertiary.
10. Under the Source subheading in each box, do *either* of the following:
 - To retain the factory setting (that is, the system uses the clock of the far-end connection), check Loop.
 - To change the setting (the clock is free-running), check Local.
11. The typical setup for the primary synchronization source is Active, and other modules are set to Not Active. Under the Activation subheading in each box, do *either* of the following:
 - If loop clock synchronization is taking place, check Active (factory setting).
 - If the clock is free-running, check Not Active.
12. Under the Channel Service Unit heading, check Foreign Exchange.

PRI Options

If the switch is part of a private network, the PRI options are automatically set. If the switch is not part of a private network, after you have completed the module information on pages 1 and 2 of Form 3b, Incoming Trunks: DS1 Connectivity (100D Module), use the instructions in this section to record these PRI options:

- Assigning B-channels to groups.
- Associating outgoing and incoming services to the group.
- For groups with incoming services, selecting an incoming routing method (Dial Plan Routing or Line Appearance) and providing routing information.
- For groups with outgoing services, completing the Network Selection, Special Services, and Call-by-Call Service tables.
- Identifying the trunk and telephone numbers sent to the network for caller identification.
- Assigning a test number used for maintenance by the service provider, changing timers and counters from the factory settings, and assigning the Terminal Equipment Identifier (TEI).

All channels assigned to a group must be on the same 100D module. Also, the order of the B-channel groups is not important. When programmed for PRI, the single DS1 jack on the 100D module supports 23 B-channels (the Channel 24 superframe transmits signaling mode information).



CAUTION:

The order in which channels are assigned within a group must be the exact opposite of the order in which the telephone company's switch hunts through for a channel. Consult with the service provider to determine what the correct order should be.

Planning Form Instructions

1. To assign B-channels to groups, determine which channels to group together and then record each group on Form 3b (page 3), under the B-Channel Groups heading:
 - a. Write the group number (1–80) under the B-Channel Group No. heading (start with 1 and number sequentially).
 - b. Write the slot and port number of each B-channel assigned to the group (see Form 2c, System Numbering: Line/Trunk Jacks). To determine the port number, assume that port 1 is at the bottom of the module to which you are assigning B-channels.
 - c. For all channels you plan to associate with the group, write the trunk number (see Form 2c, System Numbering: Line/Trunk Jacks).
2. To assign service to each B-channel group, complete Form 3b (page 4) as follows: If there is more than one 100D module set up for PRI service or you have more than eight B-channel groups assigned to a module, make copies of Form 3b (page 4) as necessary.
 - a. In the Module Slot No. space, write the number of the control unit slot that contains the module as noted on pages 1 and 2 of this form.
 - b. Under the B-Channel Group No. heading, copy the B-Channel group numbers from Form 3b (page 3).

- c. Write the services to be associated with each group under the Outgoing Services and Incoming Services headings. Select from the following services:
- **AT&T Toll.** (for 4ESS or 5ESS, see Form 3b, page 1) Megacom WATS, Megacom 800, ACCUNET SDS, Software Defined Network (SDN), MultiQuest, and Long Distance.
 - **5ESS Local.** (For switch type 5ESS, see Form 3b, page 1) OUTWATS, 56/64 Digital, Virtual Private Network, and INWATS.
 - **MCI Toll.** (for DMS-250 or DEX600E, see Form 3b, page 1) MCI Prism, MCI VNet, and MCI 800 and MCI 900.
 - **DMS-100 Local.** (for a DMS-100, see Form 3b, page 1) DMS Private Network, DMS INWATS (Inward Wide Area Telephone Service), DMS OUTWATS (Outward Wide Area Telephone Service), DMS FX (Foreign Exchange), and DMS Tie Trunk.
 - **Other.** Call-by-Call and Other.
-  **NOTE:**
If a B-channel group has more than one outgoing service, then enter Call-by-Call on Form 3b, page 4, under the Outgoing column instead of itemizing the services. Form 3b, page 8, is where you enter specific services with specific dial-out patterns.
- d. If the group has incoming services assigned, do *either* of the following:
- If the routing will be Dial Plan Routing (Hybrid/PBX mode only), check Dial Plan Routing.
 - If the routing will be by line appearance, check Line Appearance.
3. For all B-channel groups that are programmed to route calls by line appearance, assign a telephone number to each line in the B-channel group. Record the information on Form 3b (page 5):
- a. Write the B-channel group numbers and the trunk number or numbers from Form 3b (page 3).
 - b. In the Telephone Number column, write the unique inbound routing telephone number (the “directory number”) of up to 12 digits, furnished by the PRI service provider.



NOTE:

The factory does not preassign a telephone number. The telephone number you assign should be the same sent to the system by the network. The number should also be unique within the same B-channel group and must be different from the associated test telephone number. (Test telephone numbers are assigned later in this procedure.)

4. For all B-channel groups you plan to assign to Dial Plan Routing, you must program the Dial Plan Routing table to direct the system to properly route calls. Record table entries (maximum: 16 entries) on Form 3b (page 6):
 - a. For the entry to be activated, a service must be entered. In the Service cell, write *one* of the following:
 - **AT&T Toll.** (for 4ESS or 5ESS, see Form 3b, page 1) Megacom WATS, Megacom 800, ACCUNET SDS, Software Defined Network (SDN), MultiQuest, and Long Distance.
 - **5ESS Local.** (For switch type 5ESS, see Form 3b, page 1) OUTWATS, 56/64 Digital, Virtual Private Network, and INWATS.
 - **MCI Toll.** (for DMS-250 or DEX600E, see Form 3b, page 1) MCI Prism, MCI VNet, and MCI 800 and MCI 900.
 - **DMS-100 Local.** (for a DMS-100, see Form 3b, page 1) DMS Private Network, DMS INWATS (Inward Wide Area Telephone Service), DMS OUTWATS (Outward Wide Area Telephone Service), DMS FX (Foreign Exchange), and DMS Tie Trunk.
 - **Other.** Call-by-Call and Other.
 - b. In the Pattern to Match cell, write the exact pattern to match if you have more than one block of incoming numbers. If you want to match any pattern, leave it blank.
 - c. In the Total Digits in Dialed Number cell, write the total number of digits (0–14) expected in the dialed number; 0 is a wildcard (match any number). (Contact the service provider for the appropriate number.)
 - d. After the match has been made, do *either* of the following to enable the system to determine where to direct the call:
 - To delete digits, write the number of digits to delete (0–14). (The system deletes from the first digit forward.)
 - To add digits, write the exact digits to enter (up to four digits) as a prefix—for example, 7128. The factory setting is blank. (The system adds the digits to the beginning of the number.)
5. In the Network Selection Table of the outgoing tables on Form 3b (page 7), the dial pattern represents the dial code for specifying a long-distance common carrier; the asterisks represent the digits in the common carrier

identification. If the telephone company has directed you to change this information, obtain the correct entry from them. But note that the dial pattern must come first. Entry 1 represents current national standards for specifying long-distance carriers (asterisks represent the common carrier code wildcard so that anything will match). Entry 0 represents the coming national standards. The remaining entries are reserved for future use.



NOTE:

The Network Selection Table and the Special Services Table contain factory settings that reflect U.S. standards for public telephone network access. These factory settings can be modified to conform to other standards. You should not change them, however, unless the telephone company explicitly instructs you to do so.

6. In the Special Services Table:
 - a. In the Pattern to Match cell, write the exact dial pattern to match. (No wildcards are permitted.)
 - b. In the Operator cell, indicate Local Operator (OP), Presubscribed Operator (P), or No Operator service (none) associated with the pattern.
 - c. In the Type of No. cell, indicate whether the pattern is for calling National (N) or International (I).
 - d. To delete digits, write the number of digits to delete (0–4). (The system deletes from the first digit forward.)

7. For all call-by-call B-channel groups, to route all outgoing calls over a call-by-call B-channel group, you must program the Call-by-Call Service Table to direct the system to properly route calls. Record table entries (maximum: 10) on Form 3b (page 8):
 - a. In the Pattern to Match cell, write the dial pattern to match (up to 8 digits). No wildcards are permitted.
 - b. In the Call Type cell, indicate the type or types of calls that will be associated with the pattern by doing *one* of the following:
 - If all outgoing calls will be voice calls (for example, Megacom WATS), write **Voice**.
 - If all outgoing calls will be data only (for example, ACCUNET), write **Data**.
 - If outgoing calls may be either voice or data (for example, SDN), write **Both**.



NOTE:

If you indicate **Both**, make sure the service can support both voice and data calls.

- c. In the Service cell, write *one* of the following:
 - **AT&T Toll.** (for 4ESS or 5ESS, see Form 3b, page 1) Megacom WATS, Megacom 800, ACCUNET SDS, Software Defined Network (SDN), MultiQuest, and Long Distance.
 - **5ESS Local.** (For switch type 5ESS, see Form 3b, page 1) OUTWATS, 56/64 Digital, Virtual Private Network, and INWATS.
 - **MCI Toll.** (for DMS-250 or DEX600E, see Form 3b, page 1) MCI Prism, MCI VNet, and MCI 800 and MCI 900.
 - **DMS-100 Local.** (for a DMS-100, see Form 3b, page 1) DMS Private Network, DMS INWATS (Inward Wide Area Telephone Service), DMS OUTWATS (Outward Wide Area Telephone Service), DMS FX (Foreign Exchange), and DMS Tie Trunk.
 - **Other.** Call-by-Call and Other.
 - d. If the system will need to delete digits, write the number of digits to delete (0–8). (The system deletes from the first digit onward.)
8. On Form 3b, check the appropriate box for the information that will be sent to the network for outgoing PRI calls. Check Extension Only, Base Number with Extension, or Line Telephone Number.

If you check Line Telephone Number, do the following:

- Identify the trunk number.
- Write the telephone number (up to 12 digits) that identifies the company as the caller in the Telephone Number to Send column.

 **NOTE:**

There is no factory-assigned telephone number. If you assign a number, it does not have to be unique. Also, the availability of caller identification information may be limited by your local-serving jurisdiction, by availability, or by central office equipment.

9. If available, assign a test telephone number that is used for maintenance by the service provider. For each 100D module with a PRI service type, write the test telephone number (up to 12 digits) used for maintenance next to the module number under the Test Telephone Numbers heading on Form 3b (page 10).



NOTE:

The factory does not assign a test telephone number. You must assign the same number as that furnished by the PRI service provider. It must be different from the numbers assigned to other channels associated with the same B-channel group.

10. Under the Timers and Counters heading, do *either* of the following:
 - To keep the factory setting, leave the Change to column blank.
 - To change the factory setting for any timer or counter, write the new threshold on the appropriate line in the Change to column.
11. Under the Terminal Equipment Identifier (TEI) heading, do *either* of the following:
 - To keep the factory-set TEI, check 0.
 - To change the factory-set TEI, write a value from 1 to 63 in the space provided.



NOTE:

If the system includes DS1 connectivity, all local offerings of DS1 configurations must be reviewed by Lucent Technologies Sales and Design Support Center (SDSC) personnel to ensure compatibility. For more information, see [Appendix D, "T1/PRI Planner."](#) Also, information required by the facilities vendor is discussed in [Appendix E, "DS1 Connectivity Ordering."](#)

Tie Trunks

Use these instructions only if the system has tie trunks, including tie trunks emulated through a DS1 connection. Otherwise, skip to the next section, "[DID Trunks \(Hybrid/PBX Mode Only\)](#)."

If configuring T1-Tie trunks, including those with Switched 56 digital data service, complete the instructions in the "[T1 Service](#)" section first.

Tie trunks must be configured to match central office requirements or the configuration of the system to which they tie. Review tie trunk operations and make the following decisions about the way each tie trunk operates:

- Direction
- Signaling type
- E & M Signaling
- Dial mode
- Dial tone

- Answer supervision time
- Disconnect time
- Private network tandem trunks



NOTE:

See the *Network Reference* for information on private networking.

This section contains instructions for each of these options.

Planning Form Instructions

1. Transfer the trunk identification from Form 2c, System Numbering: Line/Trunk Jacks, to Form 3c, Incoming Trunks: Tie. Write the logical ID and trunk number for each tie trunk connected to the system.
2. Under the Direction heading on Form 3c, check the direction for each tie trunk next to its trunk number:
 - If the tie trunk is two-way, check the Two Way (factory-setting) column. Use this option for private networks.
 - If the trunk is one-way, check either the Outgoing column or the Incoming column.
3. Under the Signaling Type (Intype/Outtype) heading, check the appropriate column for either In or Out under the Wink, Delay, Immediate, or Automatic columns for each tie trunk. For T1 facilities used for services (for example, Megacom), consider the direction of the tie trunk and how trunk assignments will be made. Then select from the list that follows these notes:



NOTES:

- Check the same signaling type used by the system to which you are connecting. For incoming-only or two-way tie trunks, the incoming type must be the same as the outgoing type of the remote system. For outgoing-only or two-way tie trunks, the outgoing type must be the same as the incoming type of the remote system.
- Wink is the factory setting and is the preferred type, followed by Delay then Immediate. Immediate does not work with touch-tone dial mode. Use Delay for private networks.

- Automatic incoming signaling is required if the central office switch is a Lucent Technologies 5ESS or Northern Telecom DMS-100 and incoming calls are programmed to route by Line Appearance. Immediate Dial outgoing signaling should not be used for digital emulated Tie trunks using T1 Switched 56 service due to the lack of trunk integrity checking.
 - Dial-in E&M Tie trunks cannot be assigned to ring into a calling group. Only Auto-in Tie trunks can be assigned to ring into a calling group.
 - **One-way, Outgoing Tie Trunks.** All outgoing calls are placed using Automatic Route Selection, and tie trunks are not assigned to personal line or Pool buttons on telephones. Select wink signaling.
 - **One-way, Outgoing Tie Trunks.** Tie trunks are assigned to personal line or Pool buttons on telephones. Select immediate signaling.
 - **One-way, Incoming Tie Trunks.** Dialed Number Identification Service (DNIS) is included. Select wink signaling.
4. Under the E&M Signal heading, select *one* of the following signaling types to be used on the tie trunks:



NOTE:

E&M Signaling does not apply to digital emulated Tie trunks using T1 Switched 56 service and should not be set during administration of those trunks.

- If the tie trunks are connected to the other system through the local telephone company, check 1S (the factory setting).
- If the tie trunks are connected directly to a system that uses type 1S signaling and is located near this system, check 1C.



NOTE:

The 1C option assumes that the two systems are connected together without any provisioned facility, and without any signaling treatment equipment. When connecting a MERLIN LEGEND switch to another MERLIN LEGEND switch, use 1C on one switch and 1S on the other.

- If the tie trunks are connected directly to a system that uses type 5 signaling and is located near this system, check 5.



NOTE:

When connecting a MERLIN LEGEND switch to a DEFINITY switch, use the Type 5 signaling type.

5. To select dial mode: under the Inmode heading, check either the Touch-Tone column or Rotary column (factory setting) for each incoming-only and each two-way tie trunk. Use Touch-Tone for private networks.



NOTES:

- If you have checked the Incoming or two-way column for a tie-trunk's direction and Immediate for its incoming signaling type, you cannot use the Touch-Tone setting for Inmode.
 - Touch-Tone outmode can be used with Outtype Immediate trunks, but Touch-Tone inmode cannot be used with Intype Immediate Trunks.
 - Under the Outmode heading, check either the Touch-Tone column or the Rotary column (factory setting) for each outgoing-only and each two-way tie trunk.
6. To indicate whether the system provides a dial tone for people calling in on a tie trunk, check *either* of the following for each tie trunk under the Dial Tone heading:
 - If the system provides a dial tone, check Remote (factory setting). Use this setting for private networks.
 - If the system does *not* provide a dial tone, check Local.
 7. For Answer Supv. Time, do *either* of the following:
 - To keep the factory setting, check the 300 column. (Use this setting for private networks.)
 - To change to a new value, write the new value (20 to 4800 ms) in the Other column. (Use 20-ms increments.)
 8. Under the Disconnect Time heading, do *either* of the following:
 - To keep the factory setting, check the 300 column. (Use this setting for private networks.)
 - To change to a new value, write the new value (140 to 2400 ms) in the Other column. (Use 10-ms increments.)

Proceed to the next section, "[DID Trunks \(Hybrid/PBX Mode Only\)](#)."

DID Trunks (Hybrid/PBX Mode Only)

Use these instructions only if Direct Inward Dial (DID) trunks are connected to the system. Otherwise, skip to the next section, "[NI-1 BRI Connectivity](#)."



SECURITY ALERT:

DID numbers that correspond to the remote access code can be used to make calls on the system's trunks, leading to toll abuse and/or fraud. (See [Appendix A](#), "[Customer Support Information](#)," for more information about security.)

This section contains instructions for setting the following options for DID trunks:

- Type of DID Trunks
- Expected Digits
- Delete Digits
- Add Digits
- Signaling
- Invalid Destination
- Trunks Included in Blocks

These options are assigned to blocks of trunks. A maximum of two blocks is permitted.

If you want to allow remote access on DID trunks, one of the telephone numbers assigned by the telephone company must match the remote access dial code. The factory setting is 889.

If two-way DID service is available from the local telephone company, it is typically set up as Tie trunk service.



NOTES:

- If the system will have two blocks, make a copy of Form 3d and write the block number in the Block Number space. Check with the local telephone company to determine the number of digits sent.

- DID trunks cannot be assigned to ring into a calling group.



CAUTION:

Since the system can have only two blocks of DID trunks, when configuring a private network, careful planning of both immediate and future needs is essential when ordering DID trunks from the local telephone company. See the Network Reference for additional information.

Planning Form Instructions

1. On Form 3d, under the Type heading, do *either* of the following:
 - To keep the factory setting, check the Wink-Start box.
 - To change the type, check the Immediate-Start box.
2. Under the Expected Digits heading on Form 3d, do *either* of the following:
 - To show that the telephone company sends the factory-set number of digits, check the box labeled 3.
 - To show the number of digits sent by the telephone company, check one of the boxes labeled 1, 2, or 4.
3. Compare the number of digits sent by the local telephone company to the number of digits in the system numbering plan, and do *one* of the following:
 - If the system's numbering plan matches the number of digits sent by the telephone company, check 0 (the factory setting) under the Delete Digits and Add Digits headings.
 - If the number of digits sent by the local telephone company is *more* than the number of digits in the system numbering plan, specify that one to four digits be deleted from the telephone company digits by checking the appropriate number (1, 2, 3, or 4) under the Delete Digits heading.
 - If the number of digits sent by the local telephone company is *fewer* than the number of digits in the system's numbering plan, specify the specific digits (1–9999) to be added to the digits sent; check the Add these digits box under the Add Digits heading and then write the specific digits to be added in the space provided.
4. Under the Signaling heading, do *either* of the following:
 - To keep the factory-set signal, check Rotary.
 - To change the setting, check Touch-Tone. (You cannot have touch-tone if you selected Immediate-Start.)

5. Under the Invalid Destination heading, do *either* of the following. (The Invalid Destination setting applies to both blocks. You cannot specify a different setting for each block.)
 - To indicate that calls to unassigned extension numbers go to the backup position (usually the primary operator), check Send to backup position.
 - To indicate that calls to unassigned extension numbers should receive a fast busy signal, check Return to fast busy.
6. Group DID trunks into each block by assigning the DID trunks according to how incoming calls must be routed to reach the proper local and non-local extension numbers, and transfer the information from Form 2c, System Numbering: Line/Trunk Jacks to the Trunks Included in Block section of Form 3d. Write the logical ID, trunk number, and telephone number in the applicable columns.
7. Select the disconnect time for each DID trunk by doing *either* of the following under the Disconnect Time heading:
 - To keep the factory setting, check 500 ms.
 - To change the disconnect time, write the new value (10 to 2550 ms) in the Other column.

Proceed to the next section, "[NI-1 BRI Connectivity](#)."

NI-1 BRI Connectivity

To ensure proper operation of the BRI line features, the following options must be set on the MERLIN LEGEND System during system programming:

- Service Profile Identifier (SPID) for each BRI line B-channel
- Directory Number (DN) for each BRI line B-channel
- Clock Synchronization for the system
- Timers for each BRI module (system provides defaults)

The following affect the operation of the MERLIN LEGEND System. However, they are programmed on the central office switch:

- Service Configuration of the BRI lines (IOC "S", Multiline Hunt)
- Hunting pattern for a Multiline Hunt configuration

Service Profile

A Service Profile (SP) defines the interface on a BRI line between a central office and an ISDN terminal. It specifies the parameters and their values necessary to provide services to the terminal. There are standardized capability packages

called ISDN Ordering Codes (IOCs) that are configured on the central office at subscription time. The IOC contains information necessary for the central office to provide service to the system.

The MERLIN LEGEND System supports the IOC "S" capability package, which provides alternate voice/circuit-switched data on two B-channels with no packet data capability or supplementary voice features, except for the Calling Party Number/Billing Number (CPN/BN) feature, if available.

In addition to the IOC "S" capability package, the MERLIN LEGEND System supports Multiline Hunt (MLH) service for *alternate* voice *and* data hunting if the central office is a Lucent Technologies 5ESS or Northern Telecom DMS-100 switch. For a Siemens SSC EWSD switch, MLH service must be provisioned as *either* voice *or* data hunting. MLH service is provided through the *Multiline Hunt Group (MLHG)* feature on Northern Telecom DMS-100 switches, and through the *Series Completion* feature on Lucent Technologies 5ESS and Siemens SSC EWSD switches.



NOTE:

The MLHG feature on the Lucent Technologies 5ESS and Siemens SSC EWSD switches is *not* recommended for use with the MERLIN LEGEND System.

MLH service may be configured in either a linear or circular pattern. Current testing of the MERLIN LEGEND System with the central office switches supports linear hunting on a Lucent Technologies 5ESS switch, and circular hunting on the Northern Telecom DMS-100 and Siemens SSC EWSD switches. Other configurations are possible, but they are not guaranteed to work with the MERLIN LEGEND System.

The Service Profile consists of the following:

- A Service Profile Identifier (SPID), which is a unique identifier used by the central office to associate an ISDN terminal with a Service Profile.
- A Directory Number (DN) for each BRI line B-channel. This DN is usually the local telephone number that was assigned by the service provider.
- If MLH service *is not* subscribed, only one call to a particular DN will be accepted at any given time, and any station with the line appearance of the BRI line will alert. If MLH *is* subscribed, the central office will automatically hunt for the next available B-channel within the hunt group and deliver multiple calls to the same DN. If all B-channels are in use, subsequent calls to the same DN will receive standard central office treatment (such as busy tone).
- Optional features:
 - Calling Party Number/Billing Number (CPN/BN) can also be ordered at subscription time.

The local telephone company normally provides two SPIDs and DN's for each BRI line (also called a Digital Subscriber Line [DSL]) ordered. The SPID consists of a string of digits, 0 through 9, not more than 20 digits in length. The DN consists of a string of digits, 0 through 9, not more than 10 digits in length. Each DSL will use two lines on Form 3i, Incoming Trunks: BRI Options (800 NI-BRI Module).

Planning Form Instructions

1. Transfer the following information from 2c, System Numbering: Trunk Jacks, to Form 3i, Incoming Trunks: BRI Options (800 NI-BRI Module):
 - Write the logical ID in the "Logical ID" column. Skip a line between each entry.
 - Write the line number in the "Line Number" column.



NOTE:

Refer to the information provided by the local telephone company to enter the information below.

2. Write the two DN's for each BRI line in the "Directory Number" column.
3. Write the two SPIDs assigned to each BRI line in the "Service Profile Identifier" column.

Refer to the NI-1 BRI Planner form for the information needed to complete the next sections.

4. Indicate the Service Configuration of the Central Office switch:
 - If configured with IOC package "S," place a check in the IOC "S" column under the "Service Configuration" heading.
 - If configured with MLH service, indicate the type of hunt group provisioned by entering a V (voice only hunt group), D (data only hunt group), or V/D (voice/data hunt group) in either the MLHG or Series Comp. column under the Service Configuration heading as appropriate.



NOTES:

- IOC package "S" is available on the Lucent Technologies 5ESS, Northern Telecom DMS-100, and Siemens SSC EWSD switches.
 - If configured with MLH service, the MLHG feature must be used if the central office is a Northern Telecom DMS-100 switch. The Series Completion feature must be used if the central office is a Lucent Technologies 5ESS or Siemens SSC EWSD switch.
 - The MERLIN LEGEND System does not support Voice/Data hunt groups with the Siemens SSC EWSD central office switch.
5. If configured with MLH (using either the MLHG or Series Completion feature), indicate whether the hunt pattern is linear or circular by placing a check in the appropriate column under the Hunt Pattern heading.
 6. Indicate the features available on each BRI line:
 - If CPN/BN is available, place a check in the CPN/BN column, as appropriate.

Clock Synchronization



NOTE:

The following information is for planning clock synchronization in systems that are not part of a private network. For planning clock synchronization in a private network configuration, see the *Network Reference*.

If the system includes both 800 NI-BRI and 100D modules, clock synchronization planning should be completed at the same time. There is only one primary/secondary/tertiary clock for both 800 NI-BRI modules and 100D modules, with the same system programming screens used for both types.

Plan your clock source administration to minimize the need for clock switching, which is known to cause noise on active calls.

The primary, secondary, and tertiary clock sources, all three of which should be programmed if possible, should be set in the following order:

1. The loop clock sources on BRI ports with DSLs in service. If at all possible, all three clock sources should be on the same 800 NI-BRI module.
2. The loop clock source on any 100D module connected to the central office and in service.
3. The loop clock source on any 100D module in T1 mode operating in a tie-trunk configuration.
4. The local clock source on any 100D module.

If no administration has been performed, upon Frigid Start (system start-up), the first 100D or NI-1 BRI port that is in service will be the default primary loop clock source.



NOTE:

Extra BRI DSLs which are not in service should never be programmed as clock sources.

Planning Form Instructions

Refer to Form 1, System Planning, Control Unit Diagram. Complete the following information on Form 3i, Incoming Trunks: BRI Options (800 NI-BRI Module), page 2:

1. To keep the factory setting (the first slot and port found in the system provides synchronization for the system), or if assigning a different module to provide primary clock synchronization:
 - a. Enter the slot and/or DSL number (BRI only) under Primary Clock Synchronization.
 - b. Under the Source subheading, check Loop to indicate that the system uses the clock of the far-end connection (factory setting) or "Local" to indicate the clock is free-running (100D modules only).



NOTE:

The only option for an 800 NI-BRI module is loop, which is automatically assigned and is not programmable.

2. If assigning secondary or tertiary backup synchronization:
 - a. Enter the slot and DSL number (BRI only) under Secondary Clock Synchronization and/or Tertiary Clock Synchronization.
 - b. Under the Source subheading in each column, check "Loop" to indicate that the system uses the clock of the far-end connection (factory setting) or Local to indicate the clock is free-running (100D modules only).



NOTE:

The only option for an 800 NI-BRI module is loop, which is automatically assigned and is not administrable.

Timers

Timers ensure that the system takes the appropriate corrective action when the expected response is not received from the network during normal operation.



CAUTION:

Since incorrect settings can hinder the operation of BRI facilities, consult with a Lucent Technologies representative or authorized dealer before making changes. The factory-set thresholds are standard settings and should rarely be changed.

The timers, descriptions, factory settings, and allowable thresholds are shown in [Table 3-5](#).

Planning Form Instructions

On Form 3i, Incoming Trunks: BRI Options (800 NI-BRI Module), under the “Timers and Counters” heading on page 2. For each timer:

- To keep the factory setting, check the first box under the timer name.
- To change the factory setting, check the second box under the timer name and write the new threshold in the space provided.

Table 3-5. NI-1 BRI Timers

Name	Description	Factory Setting	Allowable Threshold
T200	The minimum time which Layer 2 must wait for an acknowledgment of a link establishment frame, an information frame, or a polling supervisory frame, before initiating retransmission procedures.	1,000 ms	500–5,000 ms, in increments of 500 ms
T203	The maximum time for which the Layer 2 link can remain inactive.	33 seconds	10–255 seconds, in increments of 1 second
T303	The delay in central office response after the system has sent a SETUP message to initiate an outgoing call.	4 seconds	2–10 seconds, in increments of 1 second
T305	The delay in response from the central office after the system has initiated a DISConnect message for call clearing.	30 seconds	2–60 seconds, in increments of 1 second
T308	The delay in response from the central office after the system has sent a RElease message for call clearing.	4 seconds	2–10 seconds, in increments of 1 second

Assigning Lines/Trunks

This section contains instructions for assigning lines/trunks to telephones and Direct-Line Consoles.



NOTE:

To assign lines/trunks to data-only stations, follow the instructions in [Chapter 5, "Data Communications."](#)

Forms Needed

- 2a, System Numbering: Extension Jacks
- 2b, System Numbering: Digital Adjuncts
- Use the following forms as appropriate for telephones and consoles in the system. Make one copy of the appropriate form for each extension.
 - 4b, Analog Multiline Telephone
 - 4d, MLX Telephone
 - 4e, MFM Adjunct: MLX Telephone
 - 4f, Tip/Ring Equipment
 - 4h, ETR Telephone
 - 4j, MLS Telephone
 - 5a, Direct-Line Console (DLC): Analog
 - 5b, Direct-Line Console (DLC): Digital
 - 5c, MFM Adjunct: DLC

Planning Form Instructions

1. On page 1 of Forms 4b, 4d, 4h, 4j, 5a, and 5b, transfer the following user information from Form 2a, System Numbering: Extension Jacks to each copy of each of these telephone forms:
 - a. Write the logical ID in the Logical ID space.
 - b. Write the extension number in the Extension No. space.
 - c. Write the name of the person or the location of the equipment in the Person or Location space.

2. For any voice/voice or voice/data entries in the Person or Location column of Form 2a, indicate the type of extension jack pairs under the Extension Jack Pair heading on Forms 4b and 5a, by doing *either* of the following:
 - Check the Voice Announce to Busy (voice/voice) box, and enter the logical ID and extension number under the Even-numbered jack heading.
 - Check the Simultaneous Voice and Data (voice/data) box, and enter the logical ID and extension number under the Even-numbered jack heading.
3. For any adjuncts connected to an MLX telephone using an MFM, fill in the following user information from Form 2b, System Numbering: Digital Adjuncts, on Forms 4e and 5c in the Connected to MLX extension No. space:
 - a. Write the extension number in the Extension No. space.
 - b. Write the name of the person or the location of the equipment in the Person or Location space.
4. Identify the equipment at each extension (see the floor plan):
 - a. Check the box that describes the telephone, console model, or type of tip/ring equipment.
 - b. Check the box under Adjuncts that describes the adjuncts at the extension. (Checking the Data terminal box is informational only.)

Assigning Telephone Buttons

This section contains instructions for assigning buttons to:

- Telephones in Hybrid/PBX mode
- Telephones in Key and Behind Switch mode
- DLCs

Forms Needed

- 4b, Analog Multiline Telephone
- 4d, MLX Telephone
- 4e, MFM Adjunct: MLX Telephone
- 4f, Tip/Ring Equipment
- 4h, ETR Telephone
- 4j, MLS Telephone
- 5a, Direct-Line Console (DLC): Analog

3 Lines/Trunks

Assigning Telephone Buttons

- 5b, Direct-Line Console (DLC): Digital
- 5c, MFM Adjunct: DLC

Telephones in Hybrid/PBX Mode

This section contains instructions for assigning the following kinds of buttons to telephones, or to adjuncts connected to an MLX telephone using an MFM (excluding QCC operator positions):

- System Access Ring (SA Ring) button
- System Access Voice (SA Voice) button
- System Access Originate Only (SA Orig Only) button
- Shared System Access (SSA) button
- Personal line button
- Pool button
- Loudspeaker Paging button

The system automatically assigns certain kinds of line buttons, depending on the type of equipment. For nonoperator multiline telephones, the system assigns SA Ring, SA Voice, and SA Orig Only buttons (see [Figure 3-2](#) and [Figure 3-3](#)).

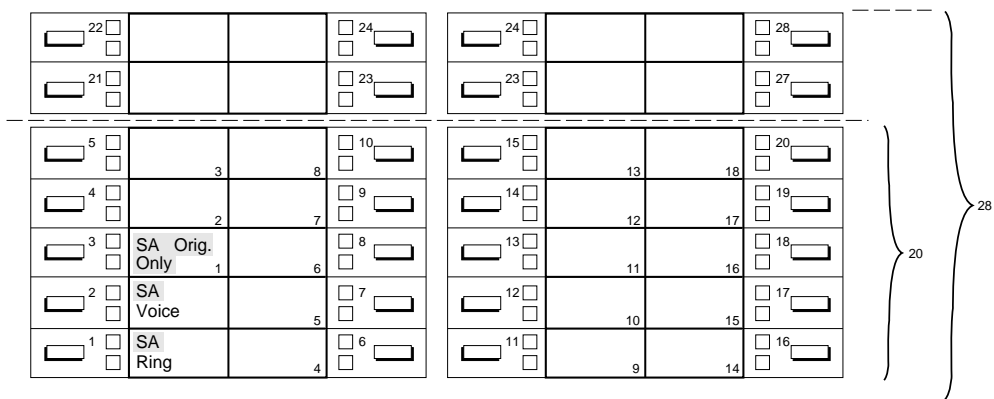

Figure 3-2. Factory-Set Assignment, MLX Telephones (Hybrid/PBX Mode)

Although equipment such as single-line telephones, analog modems, and fax machines do not have buttons, the system treats these as multiline telephones with 34 buttons.

The system assigns one SA Ring, one SA Voice, and one SA Orig Only button to every adjunct connected through an MFM to an MLX telephone. For equipment

connected to an 012 (T/R), 016 (T/R), or 008 OPT module; or, for Release 7.0 and later systems, to a port programmed for tip/ring operation on an 016 ETR or 412 LS-ID-ETR module, the system assigns two SA Ring buttons and one SA Orig Only button.

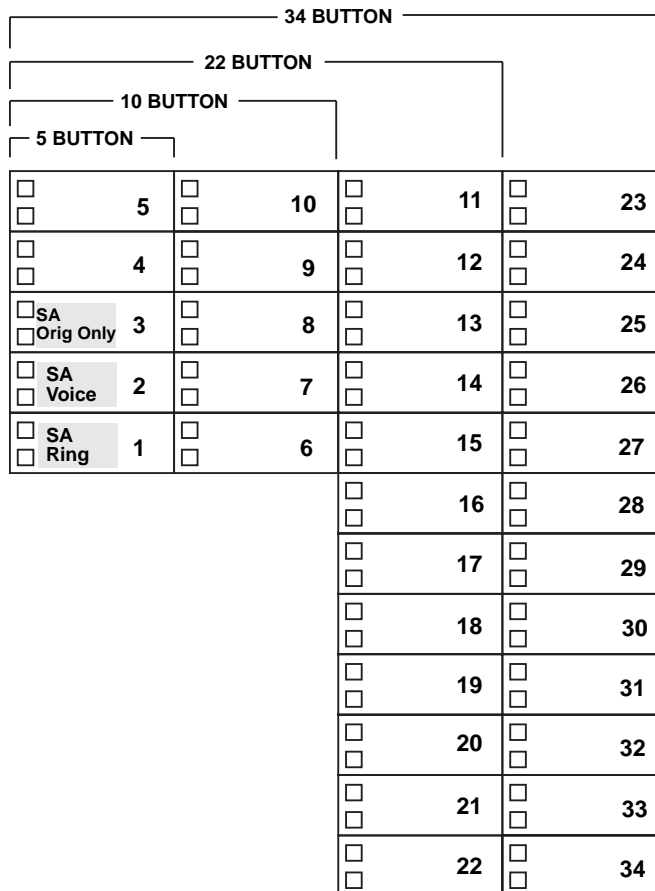

Figure 3-3. Factory-Set Assignment, Analog Multiline Telephones (Hybrid/PBX Mode)

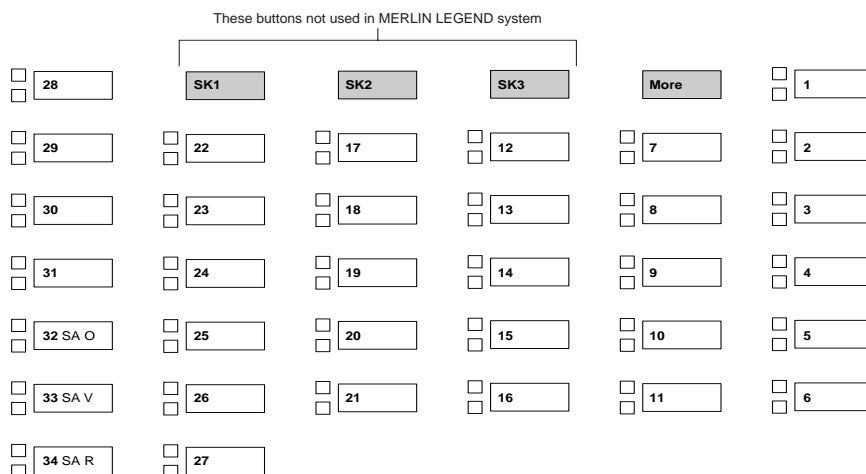

Figure 3-4. ETR-34D Telephone (Hybrid/PBX Mode)

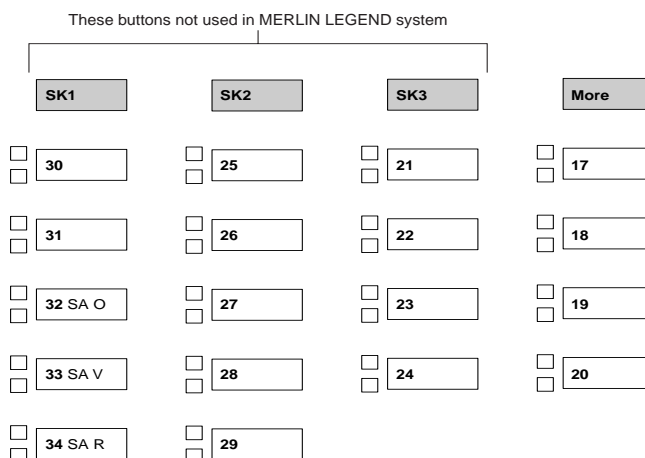

Figure 3-5. ETR-18/18D Telephone (Hybrid/PBX Mode)

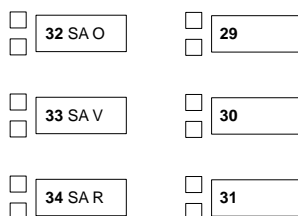

Figure 3-6. ETR-6 Telephone (Hybrid/PBX Mode)

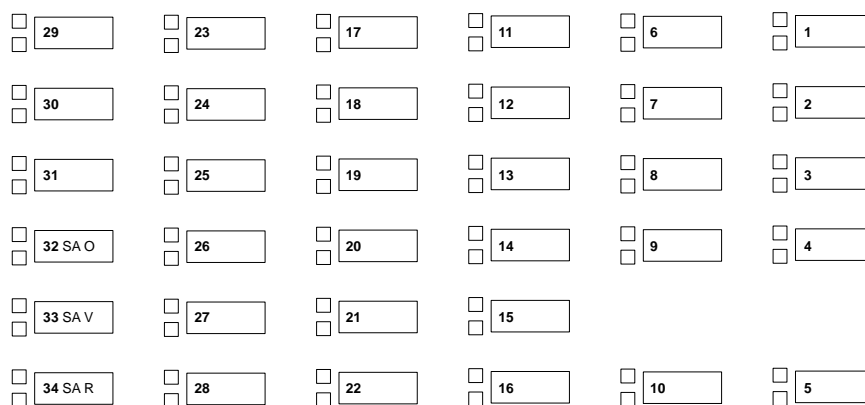

Figure 3-7. MLS-34D Telephone (Hybrid/PBX Mode)

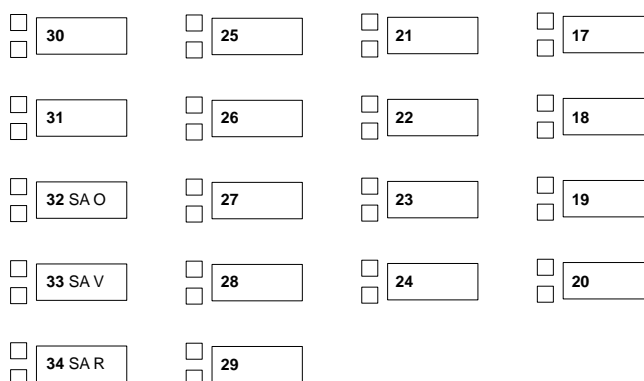

Figure 3-8. MLS-18D Telephone (Hybrid/PBX Mode)

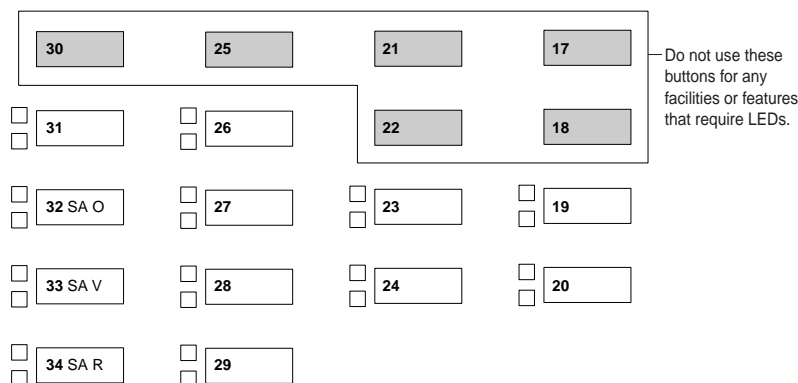

Figure 3-9. MLS-12/12D, TransTalk, or Business Cordless 905 Telephone (Hybrid/PBX Mode)

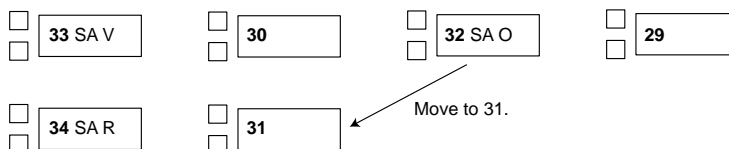

Figure 3-10. MLS-6 Telephone (Hybrid/PBX Mode)

Guidelines for Button Assignments

Use the following guidelines for assigning buttons to telephones or to adjuncts connected to an MLX telephone.



NOTES:

- When assigning buttons to telephones or adjuncts, keep in mind that BRI lines are not automatically assigned to telephones or DLCs.
- ETR or MLS telephones cannot be used as DLCs or QCCs.

For multiline telephone users:

- The system software treats the ETR-6 and MLS-6 telephones as one type of telephone. The factory-setting button assignments, however, are different. Change the SA-O button on the MLS-6 telephone to match the button's assignment on the ETR-6 telephone.
- The factory-setting button assignments for an MLS 12/12-D telephone are the same for the TransTalk and Business Cordless 905 telephones.

3 Lines/Trunks
Assigning Telephone Buttons

3-59

- For non-operator multiline telephones, you can assign SA Voice, SA Ring, and SA Orig Only buttons to the first 10 buttons on each telephone, and up to 27 SSA buttons to each telephone. However, it is recommended that the factory setting of 3 SA buttons be used to ensure that when each user is busy on a call, at least one additional button is available to receive a call and another is available to make a call. This leaves the rest of the buttons on multiline telephones free for customizing.
- An extension can have SSA buttons for another extension, but it must have at least one SA button for itself. For example, Extension A has 10 SA buttons. Extension B can have SSA buttons for up to 9 of the 10 SA buttons on Extension A; the remaining button is for B's own SA button.
- On a DLC, there can be 10 SA buttons (including SA Orig Only), but no SSA buttons. The factory setting for SA buttons is 2. It is recommended that additional SA buttons be added to ensure that the operator can transfer calls.
- On a QCC, no buttons can be programmed. However, if the QCC Voice Announce feature has been enabled, the Call 5 button becomes a VA (Voice Announce) button.
- If you plan to use Automatic Route Selection (ARS), consider keeping the factory-set button assignments. Since ARS picks the appropriate route, there is no need for Pool buttons.
- Consider assigning SSA buttons to small groups of users who need to answer and distribute each other's calls easily or join conversations. Each SSA button you assign corresponds to an SA Ring or SA Voice button on another telephone. To provide complete coverage within the group, therefore, you must be sure that each SA Ring and SA Voice button assigned to a telephone is also assigned to other members of the group. Each SA Ring or SA Voice button on a telephone can be assigned as an SSA button on up to 16 other telephones.
- Assign a Pool button when a specific trunk pool (for example, BRI, WATS or FX) is used frequently. Also consider assigning Pool buttons if you do not plan to use ARS and the system includes only one or two pools. Do not assign network pools to telephones.
- Assign personal line buttons when an exclusive private number is needed, for example, for a company executive. Any line/trunk connected to the system can be used as a personal line, as long as it is not in a trunk pool. Do not assign network trunks to telephones.

For single-line telephones, analog modems, fax machines, or any other device connected to an 012 (T/R), 016 (T/R), 016 ETR, 008 OPT, or 412 LS-ID-ETR module:

- The settings for SA buttons can be changed (see below); however, factory settings should be adequate to meet most user needs, since SA buttons can be used to make and receive both inside and outside calls.

- Single-line telephones cannot have additional SA buttons and cannot have any SSA buttons. Single-line telephones connected through an 012 (T/R), 016 (T/R), 016 ETR, 008 OPT, or 412 LS-ID-ETR module, however, can have SA buttons removed. Removing all but one SA button from single-line telephones disables features such as Transfer, Conference, and any other feature that requires more than one SA button.
- If you want the extension to receive outside calls on a specific line/trunk, assign a personal line button; if you want the extensions to receive outside calls on a line/trunk included in a pool, assign a Pool button.

For adjuncts connected using an MFM, it is recommended that you change the Button 2 assignment to SA Orig Only and remove the Button 3 assignment.

Planning Form Instructions

1. Using the guidelines above, select the types of buttons to assign to each telephone.
2. Complete the Button Diagram page of each copy of Forms 4b, 4c, 4d, 4e, 4f, 4g, 4h, 4i, and 4j.



NOTE:

The button diagrams for DLCs (Forms 5a and 5b) will be completed later.

- a. On buttons 1 through 27, indicate the types of System Access buttons by circling SA for SA Voice, SA Ring, or SA Orig Only, and writing Ring or Voice or SA Orig Only buttons and writing Shared SA, Pool, or Personal line. Then do the following, as appropriate:
 - For an SSA button, include the number of the extension with the associated SA button (see Form 2a), and the button number on that telephone.
 - For a Pool button, include the pool's extension number (see Form 2c).
 - For a personal line button, include the telephone number and record the line/trunk numbers (see Form 2c).
 - Indicate whether all but one SA button will be removed from single-line telephones on Form 4f.
- b. Assign Loudspeaker Page buttons by selecting the button and writing Page on it.

If the system includes one or more DLCs, proceed to [“Direct-Line Consoles”](#) later in this section. Otherwise, proceed to [Chapter 4](#), [“Features,”](#) to record feature assignments on these forms for each extension.

Telephones in Key and Behind Switch Mode

The line buttons you assign to the telephones, or to the adjuncts connected through an MLX telephone using an MFM, are the following:

- Intercom Ring (ICOM Ring) button
- Intercom Voice (ICOM Voice) button
- Intercom Originate Only (ICOM Orig Only) button
- Loudspeaker Paging button
- Personal line button (Key mode only)
- Prime line button (Behind Switch mode only)



NOTE:

In Behind Switch operating mode, the system automatically assigns two prime lines to each port on an MLX module — one for the MLX telephone and one for the device connected to the Multi-Function Module (MFM). If an MFM is not connected to an MLX telephone or the MLX port is not used, the prime line for the MFM can be removed. The prime line can then be assigned to other users.

Factory Assignments

The system automatically assigns certain kinds of line buttons depending on the type of equipment and the mode of operation:

- In Key mode, the system assigns an ICOM Ring button and an ICOM Voice button; the first eight outside lines connected to the control unit are assigned to each nonoperator multiline telephone, beginning with Button 3.
- In the Behind Switch mode, the system assigns an ICOM Voice button, an ICOM Ring button, and one prime line button (Button 3) to every nonoperator multiline telephone.
- For either mode, the line/trunk assignment is the same for analog multiline, MLX, ETR, and MLS telephones, except for the MLS-6 telephone.
- The factory-setting button assignments for an MLS 12/12-D telephone are the same for the TransTalk and Business Cordless 905 telephones.

[Figure 3-11](#) illustrates the factory-set button assignments for MLX telephones. [Figure 3-12](#) illustrates the factory-set button assignments for analog multiline telephones. [Figure 3-13](#) through [Figure 3-15](#) show the factory-set assignments for ETR telephones in Key mode. [Figure 3-16](#) through [Figure 3-19](#) show the factory-set assignments for MLS telephones in Key mode. For factory-set assignments in Behind Switch mode for ETR and MLS telephones, see [Figure 3-20](#) through [Figure 3-26](#).

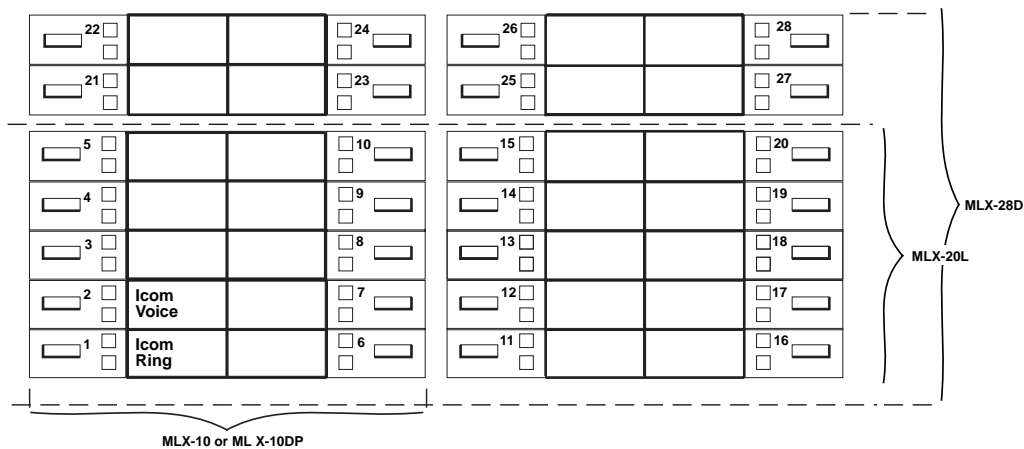

Key Mode:
 Up to 8 personal line buttons are assigned beginning with button 3.

Behind Switch Mode:
 One prime line button is assigned to button 3.

Figure 3-11. Factory-Set Assignment, MLX Telephones (Key and Behind Switch Modes)

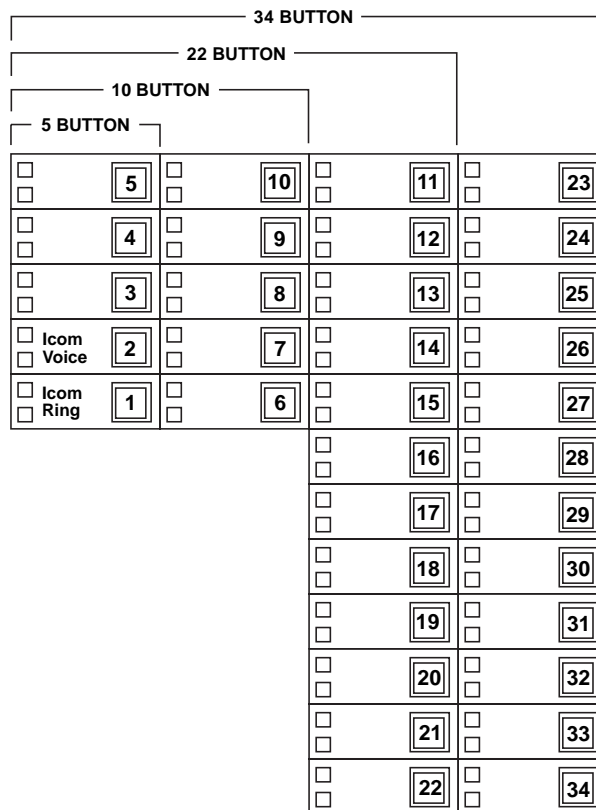

Figure 3-12. Factory-Set Assignment, Analog Multiline Telephones
 (Key and Behind Switch Modes)

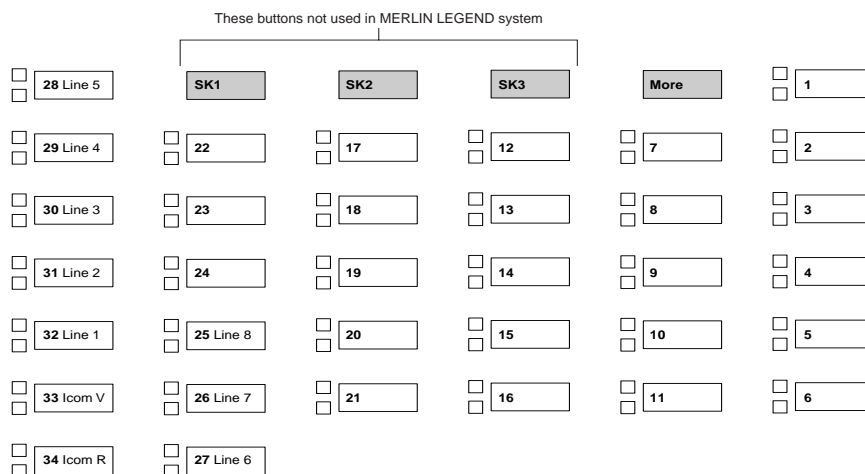

Figure 3-13. ETR-34D Telephone (Key Mode)

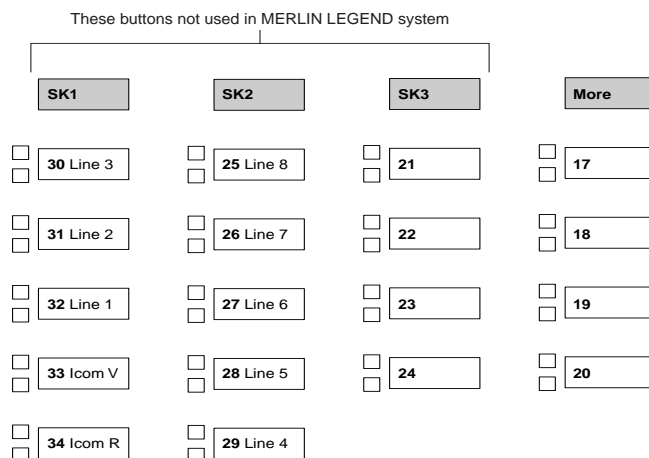

Figure 3-14. ETR-18/18D Telephone (Key Mode)

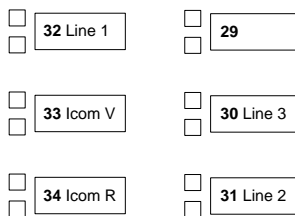

Figure 3-15. ETR-6 Telephone (Key Mode)

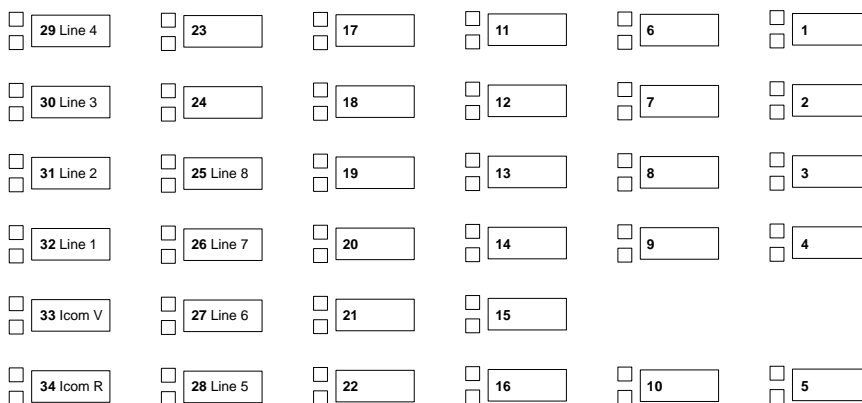

Figure 3-16. MLS-34D Telephone (Key Mode)

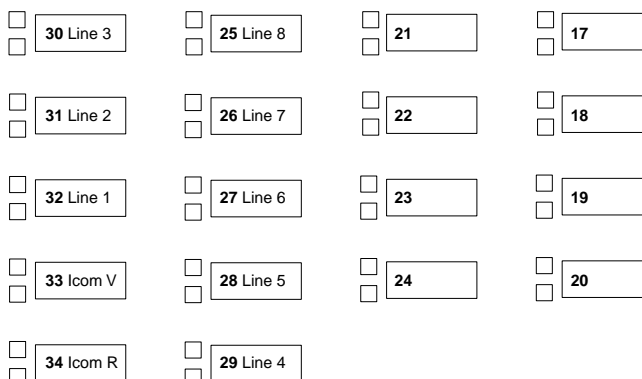

Figure 3-17. MLS-18D Telephone (Key Mode)

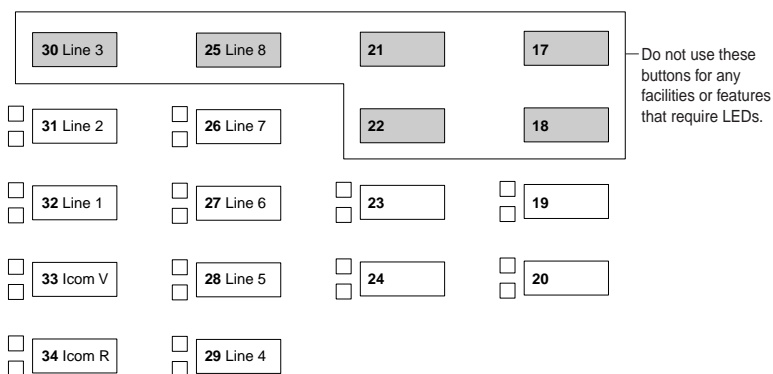

Figure 3-18. MLS-12/12D, TransTalk, or Business Cordless 905 Telephone (Key Mode)

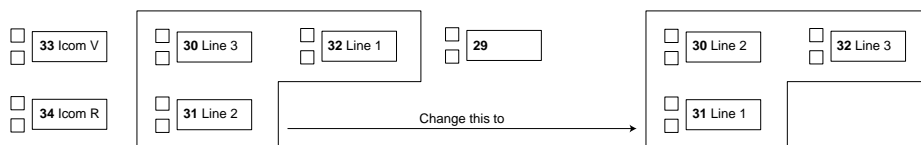

Figure 3-19. MLS-6 Telephone (Key Mode)

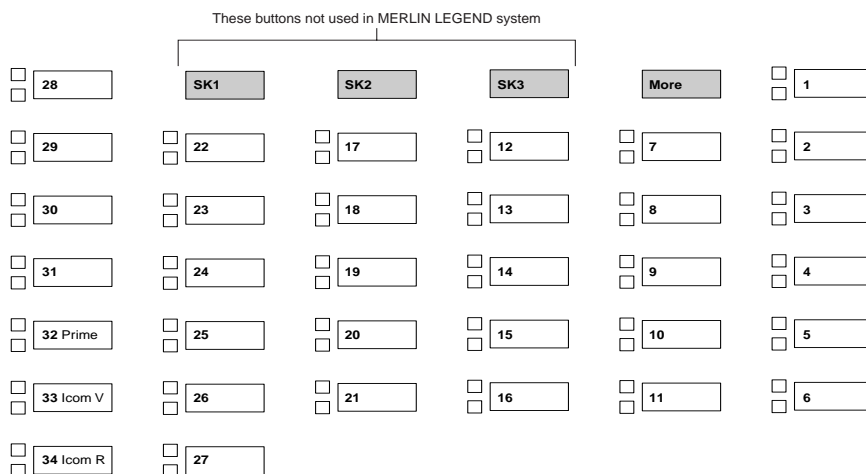

Figure 3-20. ETR-34D Telephone (Behind Switch Mode)

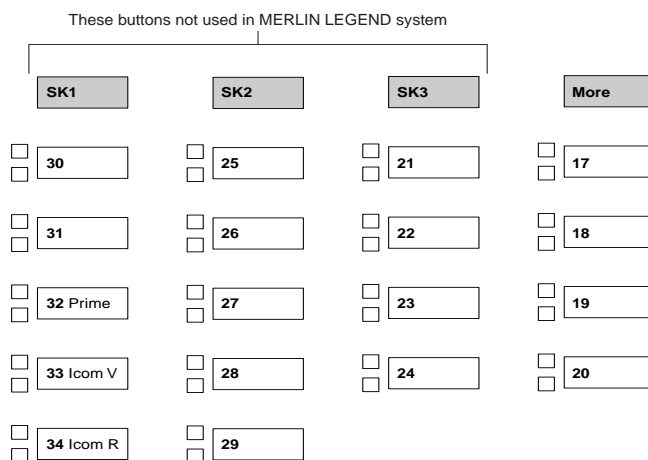

Figure 3-21. ETR-18/18D Telephone (Behind Switch Mode)

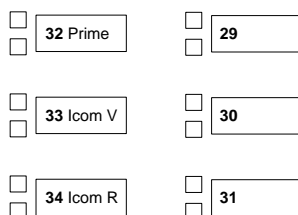

Figure 3-22. ETR-6 Telephone (Behind Switch Mode)

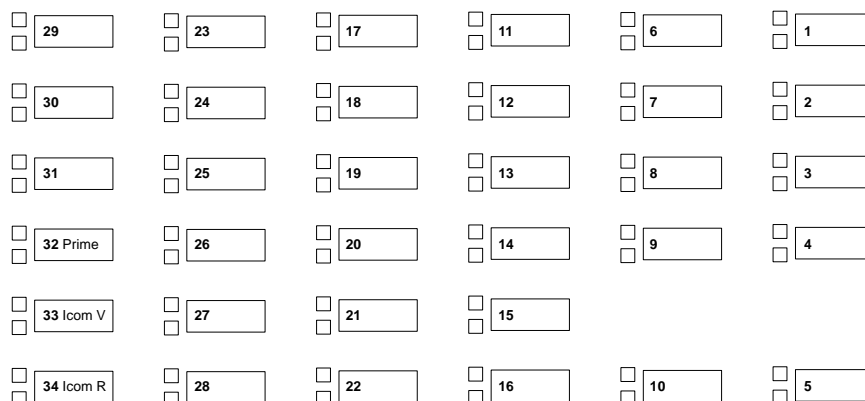

Figure 3-23. MLS-34D Telephone (Behind Switch Mode)

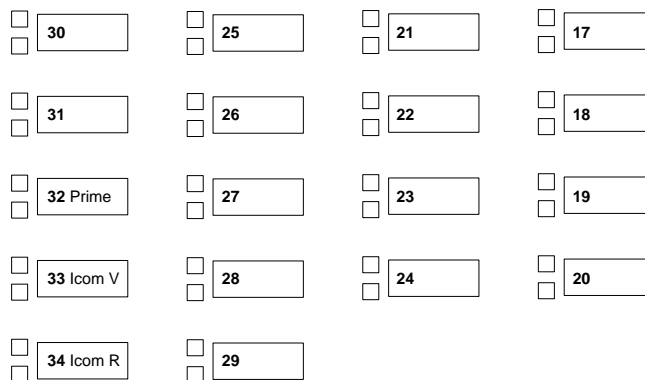

Figure 3-24. MLS-18D Telephone (Behind Switch Mode)

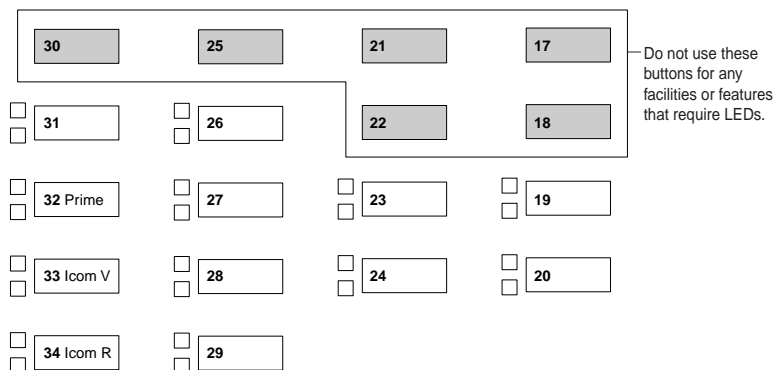

Figure 3-25. MLS-12/12D Telephone (Behind Switch Mode)

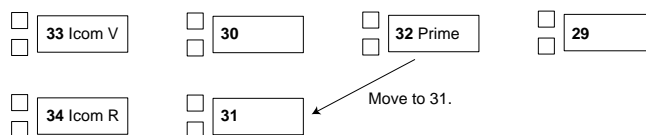

Figure 3-26. MLS-6 Telephone (Behind Switch Mode)

Although equipment such as single-line telephones, analog modems, and fax machines do not have buttons, the system treats these as multiline telephones with 34 buttons. In both Key and Behind Switch modes, the system assigns no outside lines to this type of equipment. The system assigns two ICOM Ring buttons to equipment connected to an 012 (T/R), 016 (T/R), or 008 OPT module; or, for Release 7.0 and later systems, to a port programmed for tip/ring operation on an 016 ETR or 412 LS-ID-ETR module. The system assigns an ICOM Ring and an ICOM Voice button to every adjunct connected through an MFM. You *must* remove the ICOM Voice button.

Guidelines for Button Assignments

This section contains guidelines for assigning buttons in Key or Behind Switch mode.

Key Mode

Use the following guidelines to assign buttons for a system in Key mode.



NOTE:

When assigning buttons in Key mode, keep in mind that BRI lines are not automatically assigned to telephones or DLCs.

For Key mode with multiline telephone users:

- The system software treats the ETR-6 and MLS-6 telephones as one type of telephone. The default button assignments, however, are different. Change the Line 1, Line 2, and Line 3 buttons on the MLS-6 telephone to match the buttons on the ETR-6 telephone.
- The system software automatically assigns lines to buttons on the MLS-12/12D telephone that do not have LEDs. If you are using facilities or features that require LEDs, reassign these lines to buttons that have LEDs.
- You can assign ICOM Voice, ICOM Ring, or ICOM Orig Only buttons to each extension.
- Assign an additional ICOM Ring, ICOM Voice, or ICOM Orig Only button for people who frequently receive or make transferred calls. The ICOM Orig Only button ensures that if all intercom buttons are busy, at least one is still available to make a call or to transfer the current call.
- Assign additional outside lines, including special-purpose lines such as WATS or FX.
- Remove or rearrange the eight factory-set line assignments, if desired.
- For all types of telephones for which you want the extension user to receive outside calls on a specific line, assign a personal line to a button on the telephone or adjunct.
- Consider assigning a Loudspeaker Paging button to make announcements over an optional loudspeaker connected to the control unit. To make an announcement, users press the button and speak into the handset. They do not need to dial the extension of the loudspeaker paging system.

For Key mode with single-line telephone users, analog modems, fax machines, or any other tip/ring device connected to an 012 (T/R), 016 (T/R), or 008 OPT module; or, for Release 7.0 and later systems, to a port programmed for tip/ring operation on an 016 ETR or 412 LS-ID-ETR module; or to an MFM:

- You can assign a combination of up to 10 ICOM Ring or ICOM Orig Only buttons to each extension. (At least one intercom button must be assigned to each single-line telephone or adjunct connected to an MLX telephone using an MFM.) ICOM Voice buttons should not be assigned on single-line telephones.
- If you want the extension user to receive outside calls on a specific line, assign a personal line to a button on the telephone or adjunct. The extension user is automatically connected to the intercom line when the receiver is lifted, and the user can select an outside line by dialing the dial-out code (usually a 9).

Behind Switch Mode

Use the following guidelines to assign buttons for a system in Behind Switch mode.



NOTES:

- For adjuncts connected using an MFM, you should change the Button 2 assignment to ICOM Orig Only and remove the Button 3 assignment. (MFMs are used with MLX telephones only.)

For Behind Switch mode with multiline telephones:

- The system software treats the ETR-6 and MLS-6 telephones as one type of telephone. The default button assignments, however, are different. Change the Prime button on the MLS-6 telephone to match the button's assignment on the ETR-6 telephone.
- You can assign additional lines and any outside lines connected directly to the control unit, including special-purpose lines.
- If a loudspeaker paging system is to be connected to the control unit, include a programmed Loudspeaker Paging button to make announcements over the loudspeaker system. To make an announcement, users press the button and speak into the handset. They do not need to dial the extension of the loudspeaker paging system.

For Behind Switch mode with single-line telephones, analog modems, fax machines, or any other tip/ring device connected to an 012 (T/R), 016 (T/R), or 008 OPT module; or, for Release 7.0 and later systems, to a port programmed for tip/ring operation on an 016 ETR or 412 LS-ID-ETR module; or to an MFM, you can assign additional lines and any outside lines connected directly to the control unit, including special-purpose lines.

Planning Form Instructions

1. Using the guidelines above for Key and Behind Switch modes, select the types of buttons to assign to each telephone.
2. Complete the Button Diagram page of each copy of Forms 4b, 4d, 4e, 4f, 4g, 4h, and 5c, by doing *either* of the following:
 - To keep the factory-set assignments, proceed to Step 3.
 - To change the factory-set assignments, skip to Step 4.
3. To keep the factory-set assignments:
 - For multiline telephones in Key mode, fill in the telephone number on Buttons 3 through 10. Record the line numbers (see Form 2c).
 - For multiline telephones in Behind Switch mode, fill in the extension number of the prime line on Button 3.

4. To change the factory-set assignments:
 - a. On Buttons 1 through 10, indicate the type of intercom button by circling ICOM for ICOM Voice, ICOM Ring, or ICOM Orig Only, and writing Ring, Voice, or Orig Only.
 - b. Fill in the telephone numbers (or prime-line extension numbers) to be assigned or changed. Start with Button 3 and record the line numbers on the diagram (see Form 3b).
 - c. Assign programmed Loudspeaker Paging buttons by selecting the button and writing Page on it.

Direct-Line Consoles

Use these instructions only if the system has one or more DLCs. Otherwise, proceed to [Chapter 4](#), "[Features](#)," to record feature assignments on the forms for each extension.



NOTE:

For more information on DLCs, see the *Feature Reference*.

The number of line, Direct Station Selector (DSS), and programmed feature buttons assigned to a DLC depends on the type of telephone and the number of lines/trunks connected to the system. The factory setting for DLCs is that, in addition to an SA Voice and an SA Ring button, or ICOM buttons, as many lines/trunks as possible are assigned to each console. Each line/trunk appears on a separate button, which means that the number of lines/trunks assigned is limited to the number of buttons on the console (up to a maximum of 32 buttons on the 34-button analog DLC).

If a DSS is present, the system assigns a DSS button for each extension number associated with an extension and special-feature buttons that are used by the DLC operator for call-handling functions.

[Figure 3-27](#) and [Figure 3-28](#) show initial line/trunk and feature assignments for MLX and analog DLC consoles. Refer to the appropriate figure as you select line/trunk assignments for DLCs.



NOTE:

System Access buttons appear on DLCs in Hybrid/PBX mode. Intercom buttons appear on DLCs in Key or Behind Switch mode.

3 Lines/Trunks
 Assigning Telephone Buttons

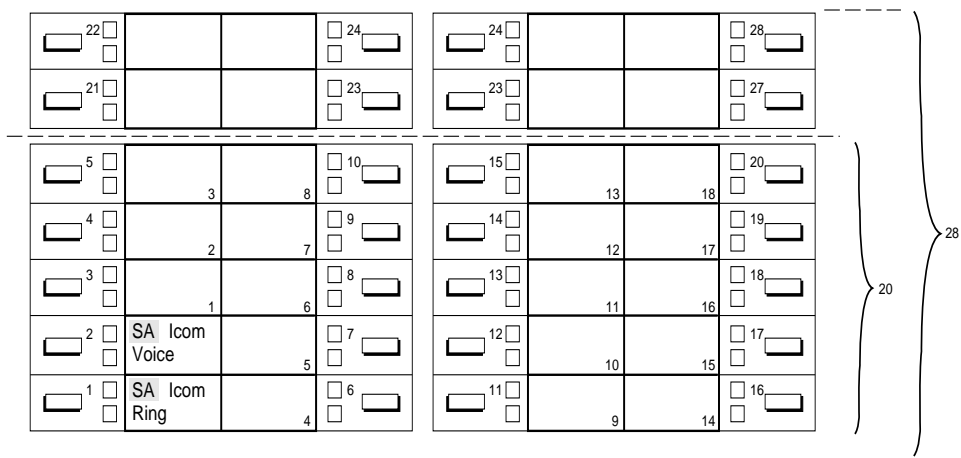

Figure 3-27. MLX Direct-Line Console

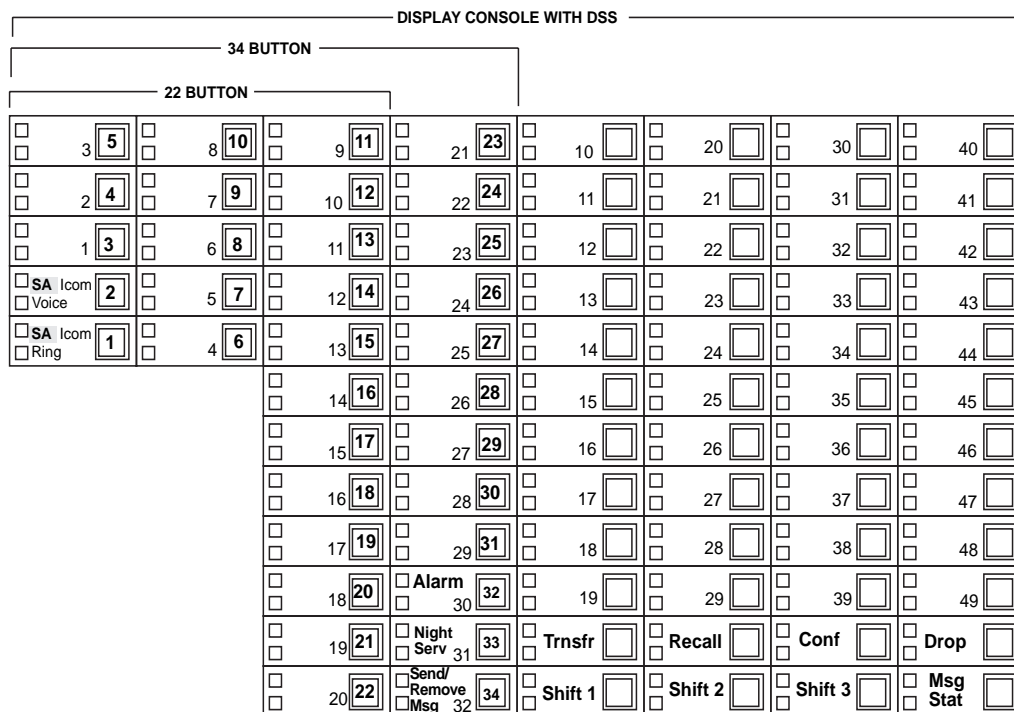

Figure 3-28. Analog Direct-Line Console



NOTE:

If the system has more than 29 lines, Alarm, Night Service, and Send/Remove Message are replaced with lines 30, 31, and 32.

The system assigns lines/trunks to buttons on DLCs in the order in which the lines/trunks are connected to the control unit. You can change the factory-set assignments by removing, adding, or changing the order in which lines/trunks are assigned to buttons for each DLC operator.

If the system has more than the number of factory-assigned lines/trunks to operator consoles, be sure to change the line/trunk assignment so that all lines/trunks you want answered by a DLC operator appear on at least one operator position.

Decide which lines/trunks should appear on each DLC operator console based on each operator's call-handling responsibilities. All operators may not need the same assignments. DLC operators who are responsible for answering calls for specific groups usually need only the lines/trunks used by group members.

If the system includes a loudspeaker paging system, consider assigning a programmed Loudspeaker Paging button to DLC positions for one-touch access to the paging equipment. If the system has fewer than 30 lines, the operator-only features (Alarm, Night Service, and Send/Remove Messages) are factory-assigned as shown in [Figure 3-27](#). The factory assignments can be changed through centralized telephone programming or by a DLC operator.

Planning Form Instructions

Complete the Button Diagram page on each copy of Form 5a and Form 5b:

1. For the Ring and Voice buttons, circle SA or Icom.
2. Write the telephone number of the line/trunk you want to assign in the space on the Button Diagram page. Record each line/trunk number (see Form 2c).
3. Assign Alarm, Night Service, or Send/Remove Message buttons by labeling the appropriate button **Alarm**, **Nite Svc**, or **Snd/Rem Msg**.
4. Assign programmed Loudspeaker Paging buttons by selecting the button and writing **Page** on it.

Proceed to [Chapter 4](#), "[Features](#)," to complete the remaining sections of these forms.

3 Lines/Trunks
Assigning Telephone Buttons

3-76

Features

4

The system offers many optional features. This chapter contains instructions for assigning features in the following categories:

- **Telephone and Extension Features.** Individual telephones, consoles, or adjuncts are assigned these features. Some features may be assigned to other equipment at an extension.
- **Operator Features.** All operator consoles are assigned these features.
- **Group-Assigned Features.** These features are used by functional groups of users (such as separate departments).
- **System Features.** All or most users on the system use these features.

Detailed information about all features (including the considerations, constraints, and feature interactions that may impact their use) is contained in the *Feature Reference*. You should be familiar with this information before you attempt to perform the procedures in this chapter.

Since certain features are optional, you can simply skip those sections that do not apply to the system.

Each individual telephone form is a complete record for that specific telephone for planning, programming, and subsequent reference by the system manager. Some features noted on the individual telephone forms are not described in this book—for example, Abbreviated Ring, Call Waiting, and Automatic Line Selection. For more information about these features, see the *Feature Reference*.



NOTE:

Except for some telephone-specific features—for example, microphone operation—many of the features described in this chapter can be assigned to other equipment, such as a data terminal or fax machine. Therefore, throughout this chapter, the more general term “extension” is often used instead of, or in addition to, “telephone.”

Telephone and Extension Features

This section contains instructions for assigning some optional features to extensions. These features may be used by both system operators and general users:

- Pool Dial-Out Code Restriction (Hybrid/PBX mode only)
- Calling Restrictions
- Forced Account Code Entry (not QCC)
- Microphone Operation
- Remote Call Forwarding (not QCC)
- Fax Message-Waiting Receiver and Threshold
- Trunk-to-Trunk Transfer
- HotLine (single-line telephones only)
- Service Observing (MLX only for Service Observer, any telephone for a Service Observing group member except QCC or CTI link)



NOTES:

- The Service Observing button is administrable only via centralized telephone programming.
- Service Observing may be subject to federal, state, or local laws, rules, or regulations or require the consent of one or both of the call parties. You must check in your jurisdiction and comply with all applicable laws, rules, and regulations before using this feature. Failure to comply may result in severe penalties.

The system programmer and/or network administrator assigns these features.

There are additional extension features noted on the forms but not covered in this book. Individuals normally program these features at their telephones, although the system manager may also program these features using centralized telephone programming. You may, however, want to complete the information on the forms so they can serve as a complete summary of features for each extension. Detailed information about these and all features is contained in the *Feature Reference*. Instructions for using centralized telephone programming are included in *System Programming*. For users who want to program features on their own telephones, information and procedures are contained in the user and operator guides.

You may choose the Extension Copy feature to create a template that can then be copied to other similar extensions whose users require the same features. This feature is also described later in this section.

Forms Needed

- 2a, System Numbering: Extension Jacks
- 4b, Analog Multiline Telephone
- 4d, MLX Telephone
- 4e, MFM Adjunct: MLX Telephone
- 4f, Tip/Ring Equipment
- 4h, ETR Telephone
- 4j, MLS Telephone
- 5a, Direct-Line Console (DLC): Analog
- 5b, Direct-Line Console (DLC): Digital
- 5c, MFM Adjunct: DLC
- 5d, Queued Call Console (QCC)
- 6b, Optional Extension Features
- 6g, Call Restriction Assignments and Lists
- 6h, Authorization Codes
- 6i, Pool Dial-Out Code Restrictions
- 11, Service Observing: Group Assignment
- Floor plan

Queued Call Console (Hybrid/PBX Mode Only)

Use these instructions if the system includes one or more QCCs. Otherwise, skip to the next section, "[Pool Dial-Out Code Restriction \(Hybrid/PBX Mode Only\)](#)."

Planning Form Instructions

1. Transfer the user information from Form 2a, System Numbering: Extension Jacks to each copy of Form 5d, by filling in the Logical ID, Extension No., and Person or Location spaces. Use the Button Diagram on Form 5d as a guide for labeling the operator console buttons. You cannot change the button assignments shown. If the QCC Voice Announce feature is enabled, however, the Call 5 button becomes a VA (Voice Announce) button. Refer to the "[Operator Features](#)" section later in this chapter.
2. Check the box under the Adjuncts heading that applies to the equipment at the extension (see the floor plan).
3. Under Message Center Operator, check No if the QCC will not be a message center, or Yes if it will be a message center.



NOTE:

If a calling group member is programmed as a QCC, the extension is removed from the calling group. If a Service Observing group member is programmed as a QCC, the extension is removed from the Service Observing group. If a Service Observer extension is programmed as a QCC, the extension is removed as a Service Observer.

Proceed to the next section, "[Pool Dial-Out Code Restriction \(Hybrid/PBX Mode Only\)](#)."

Pool Dial-Out Code Restriction (Hybrid/PBX Mode Only)

This section contains instructions to tailor the use of dial-out access codes by restricting extensions from making calls on specific trunk pools (for example, those consisting of special-purpose lines/trunks such as WATS or FX), or to reserve trunk pools for data communications only.

Planning Form Instructions

Use Form 6i to identify those extensions that are restricted from using some dial-out access codes. The factory setting is for *all* extensions to be restricted from using *all* dial-out access codes. This form only identifies extensions that are to remain restricted. Extensions that are not listed on this form must have their restrictions removed through system administration. All extensions should be restricted from dialing private network pools.

Calling Restrictions

This section contains instructions to restrict selected extensions from making outside calls—for example, for telephones in a reception area and to control toll-call abuse—but still allow local and intercom calls.



SECURITY ALERT:

Calling restrictions [for example, Disallowed Lists, toll restriction, and Facility Restriction (FRL) Levels] should be programmed, as appropriate, to minimize toll fraud abuse. Refer to the "Calling Restrictions" section in the Feature Reference for additional information on programming calling restrictions.

Planning Form Instructions

If these restrictions are too limited, use [“Allowed Lists”](#) and [“Disallowed Lists,”](#) as described later in this chapter.

Use Form 6h to identify Authorization Codes for use by the users of certain extensions. After you complete Form 6h, remove it from the forms set and keep it in a secure place.

Use Form 6g, Call Restriction Assignments and Lists, to identify the extensions with calling restriction assignments. List the extensions with calling restrictions in the Ext. No. column and the type of restriction in the Restriction Type column. The factory setting is Restricted.



NOTE:

Setting this option to Outward Restrict or Toll Restrict does *not* allow reliable toll restriction on telephone company lines/trunks that do not require 1 or 0 for toll calls. The Toll Type setting of 1 or 0 allows the system to classify calls as either local or toll, based on the number a user dials. Dialing a prefix depends on local telephone company requirements and the type of trunk being used. The system must be programmed to designate whether or not to restrict users from dialing calls to certain areas. The Toll Type feature does *not* apply to DID trunks or private network tandem trunks.

To restrict the extension from making outside calls so only intercom or private network calls can be made, check the Outward Restriction column.

To restrict the extension from making toll calls so only intercom, local, or private network calls can be made, check the Toll Restriction column.

Forced Account Code Entry

This section contains instructions for setting up the system to associate calls with corresponding accounts, clients, or projects for billing and accounting purposes.

Planning Form Instructions

Use Form 6b to identify extensions requiring Forced Account Code Entry. Under the Forced Account Code Entry heading on Form 6b, do *either* of the following:

- To allow users to make calls without entering an account code, check the No (factory setting) box.
- To require users to enter an account code, check the Yes box.

Microphone Operation

This section contains instructions to disable the microphones on MLX telephones when they are used in areas where use of the speakerphone is disruptive.

Extensions that interact with a CTI-capable program on a computer (extensions marked Computer Telephony Integrated Client PC on forms 4b, 4d, 4h, or 4j) should not have their microphones disabled.



NOTE:

The microphones on analog multiline telephones cannot be disabled.

Planning Form Instructions

Under the Microphone heading on Form 6b, do *one* of the following:

- To allow speakerphone use (factory setting), check Enable.
- To prevent speakerphone use, check Disable.

Remote Call Forwarding

This section contains instructions to allow users to forward calls to outside numbers and to allow users to “screen” their calls through use of the Forwarding Delay option. With the Forwarding Delay option activated, incoming calls ring at the called extension a specified number of times (from 1 to 9 rings) before the call is forwarded.



SECURITY ALERT:

Remote Call Forwarding can only be used securely when used on ground-start line/trunks or loop-start lines/trunks with “reliable disconnect” (sometimes referred to as forward disconnect or disconnect supervision). Toll fraud can occur when loop-start lines/trunks are used with unreliable disconnect. If the calling party stays on the line after the called party hangs up, the central office will return a dial tone at the conclusion of the call, enabling the caller to place another call as if it were being placed from your company.

Remote Call Forwarding and the Forwarding Delay option are programmed for each extension. Assign these features to selected extensions, for example, for people who often work away from the office. Remote Call Forwarding cannot be assigned to QCCs. If there is a personal line assigned to a telephone, you can specify that calls on that line be forwarded to an outside number if the extension is the principal user of the personal line.

Ensure that the number of rings for Remote Call Forwarding is less than the Coverage Delay or the call will not forward.

Planning Form Instructions

1. Under the Remote Call Forwarding heading on Form 6b, do *either* of the following:
 - To prevent users from forwarding calls to outside numbers (factory setting), check the Not Allowed column and proceed to the next section, "[Fax Message-Waiting Receiver](#)."
 - To provide Remote Call Forwarding, check the Allowed column, then proceed to Step 2.
2. If you want a user to be able to forward the incoming calls on a specific line or lines to another number, write the extension number in the spaces provided on Form 6c, Principal User of Personal Line.
3. If Remote Call Forwarding is enabled, do *either* of the following:
 - If you wish to disable the Forwarding Delay option, enter 0 in the Delay (0–9) column under the Remote Call Forwarding heading on Form 6b. This causes incoming calls to be forwarded immediately.
 - If you wish to enable the Forwarding Delay option for an extension, enter the number of times an incoming call should ring at the called extension (1–9 rings) before the incoming call is forwarded.



NOTES:

- If Do Not Disturb (DND) and Forwarding Delay are both active, DND overrides the Forwarding Delay and the call is forwarded immediately.
- Due to the timing of when the ringing signal is applied to a single-line telephone, and the interval of that ringing signal, single-line telephones may appear to have their calls forwarded one ring sooner than the programmed number.

Fax Message-Waiting Receiver

Use these instructions only when the system has fax machines connected directly to the control unit by way of an 012 (T/R), 016 (T/R), 016 ETR, 412 LS-ID-ETR, or 008 OPT module or connected to an MLX telephone using a Multi-Function Module (MFM). Otherwise, skip to the section, "[Operator Features](#)."

Fax machines cannot use General-Purpose Adapters (GPAs) because they cannot auto dial through the GPA.

This section contains instructions to designate from one to four telephones to receive message-waiting indications when a fax is received on a specific fax machine, and to specify the length of time before the system assumes a fax has arrived and sends the message-waiting indication.

Planning Form Instructions

Use Form 6d to identify up to 16 fax machine extension numbers and up to four receiver extension numbers for each fax number.

The System Notification Threshold setting can be left at the factory setting of 10 seconds or changed and identified on the line at the top of the form for up to 30 seconds.



NOTE:

You will fill in the rest of the optional telephone features later.

Trunk-to-Trunk Transfer

This section contains instructions to allow or disallow trunk-to-trunk transfer at each extension.

If trunk-to-trunk transfer is disallowed on an extension in a private network, the extension cannot transfer an outside call to a local system trunk connected to the PSTN. See the *Network Reference* for more information.

Trunk-to-trunk transfer may only be performed on ground-start trunks and loop-start trunks with reliable disconnect. As of Release 4.0, trunk-to-trunk transfer may be performed on BRI, Tie lines, PRI, ground-start trunks, and loop-start trunks that have reliable disconnect.

Trunk-to-trunk transfer is factory set to disabled and may be enabled for a specific extension. Single-line telephones are restricted from completing a trunk-to-trunk transfer.

Planning Form Instructions

Use Form 6b to identify extensions permitted to perform trunk-to-trunk transfers. Under the Trunk-to-Trunk Transfer heading on Form 6b, do *either* of the following:

- To block an extension from completing a trunk-to-trunk transfer, check the No (factory setting) check box.
- To allow an extension to complete trunk-to-trunk transfers, check the Yes check box.

HotLine

The HotLine feature is available only for single-line telephones and devices connected to a port on an 012 (T/R), 016 (T/R), 016 ETR, 412 LS-ID-ETR, or 008 OPT module. A single-line telephone connected to an MFM cannot use the HotLine feature. This feature enables you to set up a telephone to dial one specific number once the telephone goes off-hook. The number that is dialed is the first personal speed dial (code 01) programmed on the single-line telephone using centralized telephone programming or extension programming. (Extension programming is only available before the HotLine feature is activated.)

A HotLine extension can call a private network extension. See the *Network Reference* for information.



NOTE:

In Release 6.0 and later systems, after the Hotline extension number has been assigned, the FRL value for the Hotline extension number should be set to 6. This ensures that, regardless of the FRL value assigned to the route or routes in the UDP Routing Table connecting two switches in a private network, placing a UDP call from switch A directly connected to switch B using the Hotline feature will not fail due to the FRL.

Planning Form Instructions

On Form 4f specify if this device will use the HotLine Feature. Under the HotLine heading on Form 4f, do *either* of the following:

- To set the extension to not use the HotLine feature, check the Off (factory setting) box.
- To set the extension to be a HotLine extension, check the On check box. Enter the extension or telephone number that the HotLine extension dials when it is taken off-hook in the space provided below the On box.

Extension Copy

The Extension Copy feature enables you to copy an extension's programmed buttons (with some exceptions) to one or more extensions. The features are individually programmed on one extension to create a template that can then be copied to other extensions in the system. You can make additional copies of these forms and have several templates for different groups of users.

Only similar types of extensions can be copied to each other (for example, analog to analog or MLX to MLX) because each extension type has a different button layout. For a system that has each telephone type, you need at least four templates, one for analog, one for MLX, one for ETR, and one for MLS telephones.

4 Features

Telephone and Extension Features

4-10



NOTE:

A Multi-Function Module (MFM) extension can be copied to or from another MFM extension. An analog DLC extension can only be copied to another analog DLC extension. An MLX DLC extension can only be copied to another MLX DLC extension. Single-line telephones and QCCs *cannot* use the Extension Copy feature.

[Table 4-1](#) contains a list of the features that can be copied and whether the features apply to analog multiline, MLX, ETR, or MLS telephones, or to all of them. Following the table is a list of operator features that can be copied.

Table 4-1. Features that Can Be Copied

Feature	MLX	Analog Multiline	ETR	MLS
Account Code Entry	✓	✓	✓	✓
Authorization Code	✓	✓	✓	✓
Auto Answer All		✓		
Auto Answer Intercom		✓		
Auto Dial Inside	✓	✓	✓	✓
Auto Dial Outside	✓	✓	✓	✓
Barge-In	✓	✓	✓	✓
Callback-Selective	✓	✓	✓	✓
Caller ID Toggle Button	✓		✓	✓
Camp-On	✓			
Conference ¹	✓	✓	✓	✓
Coverage Off	✓	✓	✓	✓
Coverage VMS Off	✓	✓	✓	✓
Data Status	✓	✓	✓	✓
Direct Voice Mail	✓	✓	✓	✓
Do Not Disturb	✓	✓	✓	✓
Drop ¹	✓	✓		
ETR Drop			✓	✓
Extension Status 2 (ES2) (Non-operator)	✓	✓		
Extension Status 1 (ES1) (Non-operator)	✓	✓		
Feature Button		✓		

4 Features

Telephone and Extension Features

Table 4-1. Features that Can Be Copied — *Continued*

Feature	MLX	Analog Multiline	ETR	MLS
Forward	✓	✓	✓	✓
Group Calling	✓	✓	✓	✓
Group Page	✓	✓	✓	✓
Headset Auto Answer	✓			
Headset Hang Up	✓			
Headset Status	✓			
Headset/Handset Mute	✓			
Last Number Dial ²	✓	✓	✓	✓
Messaging:				
Delete Message		✓		
Leave Message	✓	✓	✓	✓
Message Light Off	✓	✓	✓	✓
Next Message		✓		
Posted Message	✓	✓		
Return Call		✓		
Scroll Message		✓		
Park	✓	✓	✓	✓
Pickup:				
Group	✓	✓	✓	✓
General	✓	✓	✓	✓
Extension	✓	✓	✓	✓
Line	✓	✓	✓	✓
Privacy	✓	✓	✓	✓
Recall	✓	✓	✓	✓
Reminder Service:				
Set	✓	✓	✓	✓
Cancel	✓	✓	✓	✓
Saved Number Dial ²	✓	✓	✓	✓
Selective Callback	✓	✓	✓	✓

4 Features

Telephone and Extension Features

4-12

Table 4-1. Features that Can Be Copied — Continued

Feature	MLX	Analog Multiline	ETR	MLS
Signaling	✓	✓	✓	✓
System Access: ³				
SA/ICOM Originate Only	✓	✓	✓	✓
SA/ICOM Ring	✓	✓	✓	✓
SA/ICOM Voice	✓	✓	✓	✓
System Speed Dial	✓	✓	✓	✓
Transfer ¹	✓	✓	✓	✓

1 Behind Switch mode only.

2 Number is *not* copied.

3 Ringing options (No Ring, Delay Ring, and Immediate Ring) are copied with the button.

The following are operator features that can be copied:

- Alarm
- Extension Status Off
- Extension Status 1
- Extension Status 2
- Missed Reminder
- Night Service
- Operator Park
- Send/Remove Message

Planning Form Instructions

1. On page 1 of Form 4a and/or Form 4c, write the extension number of the Master Extension and the extensions to which this template will be copied.
2. Complete the Button Diagram on page 2 of Form 4a and/or Form 4c, assigning features to the buttons.
3. On the individual telephone forms (Forms 4b, 4d, 4e, 4h, 4j, 5a, 5b, and 5c) do the following:
 - a. By the extension information at the top of each page, check Copied from Master Extension No. and write the extension number of the Master Extension.
 - b. Under every form's Button Diagram heading, check the See Master Extension box.

Cover Ring Delay

Beginning with Release 4.1, the following ring delay options can be programmed for extensions:

- The Group Coverage Ring Delay is programmed on individual sender extensions and replaces the Coverage Delay Interval programmed on a systemwide basis in previous releases.
- When used in conjunction with Secondary Cover buttons, consider the following when setting the value:
 - When secondary cover buttons are programmed for a sender, set the value such that when the Group Coverage Ring Delay is added to the Primary Cover Ring Delay, the result is greater than the Secondary Ring Delay plus two rings (the fixed Secondary Cover Delay Interval).
- The Primary Cover Ring Delay and Secondary Cover Ring Delay are programmed on individual sender extensions and replace the Delay Ring Interval programmed on a systemwide basis.

Forms Needed

- 4b, Analog Multiline Telephone
- 4d, MLX Telephone
- 4e, MFM Adjunct: MLX Telephone
- 4f, Tip/Ring Equipment
- 4h, ETR Telephone
- 4j, MLS Telephone
- 5a, Direct-Line Console (DLC): Analog
- 5b, Direct-Line Console (DLC): Digital
- 5c, MFM Adjunct: DLC
- 7c, Group Coverage

Planning Form Instructions

1. After assigning Individual Coverage for each receiver telephone, locate the appropriate form for each sender telephone (Form 4b, 4d, 4f, 4h, 4j, 5a, or 5b).
2. Under the Primary Cover Ring Delay heading, do one of the following:
 - To keep the factory-set delay, check the 2 rings box.
 - To change the factory-set delay, check the second box and write the number of rings (1–6) in the space provided.

4 Features

Telephone and Extension Features

4-14

3. Under the Secondary Cover Ring Delay heading, do one of the following:
 - To keep the factory-set delay, check the 2 rings box.
 - To change the factory-set delay, check the second box and write the number of rings (1–6) in the space provided.
4. After assigning senders to Group Coverage on form 7c, locate the appropriate form for each sender telephone (Form 4b, 4d, 4f, 4h, 4j, 5a, or 5b).
5. Under the Group Coverage Ring Delay heading, do one of the following:
 - To keep the factory-set delay, check the 3 Rings box.
 - To change the factory-set delay, check the second box and write the number of rings (1–9) in the space provided.

Service Observing

This section contains instructions for setting up Service Observing so that a designated observer can monitor a call at any extension that is a member of the Service Observer's group. Service Observing is available only in Release 6.1 and later systems.



NOTE:

Service Observing may be subject to federal, state, or local laws, rules, or regulations or require the consent of one or both of the call parties. You must check in your jurisdiction and comply with all applicable laws, rules, and regulations before using this feature. Failure to comply may result in severe penalties.

You can establish up to 16 Service Observing groups on a system. Each group consists of one Service Observer and a list of the stations (up to the system maximum of 400) that the observer is allowed to monitor. A warning tone is programmed on a per group basis to provide an audible indication that an extension is being observed.



NOTES:

- Any MLX extension (except QCC or CTI link) may be a Service Observing extension.
- A Service Observing button must be assigned to the observer's MLX telephone and is programmed only via Centralized Telephone Programming.
- Any extension (except QCC or CTI link) may be a group member.
- If an extension becomes a QCC or CTI link, it is removed from all Service Observing groups.

4 Features

Telephone and Extension Features

4-15

- A Service Observer may be a member of another Service Observing group. Any extension may be a member of more than one Service Observing group.
- The Service Observer and all extensions in a Service Observing group must be on the local switch.
- Data, video, page, and reminder service calls, and calls at VMI ports and delay announcement devices cannot be observed.
- An adjunct that is connected to an MFM can be observed but cannot be an observer.

Forms Needed

- 4d, MLX Telephone
- 5b, Direct-Line Console (DLC): Digital
- 11, Service Observing: Group Assignment

Planning Form Instructions

Determine which stations will be assigned as Service Observers and complete the following on page 1 of Forms 4d and 5b:

- In the Centralized Programming Requirements section, check the Assign Service Observing Button box for each MLX telephone that will have a Service Observing button assigned. Any extension with a programmed Service Observing button may be assigned as an Observer extension.

Determine the number of Service Observing groups needed. Then, for each group, complete the following on Form 11:

1. Write the group number in the Group No. space.
2. Write the extension number for the group Observer in the Observer Ext. No. space. The Observer's extension must have a Service Observing button.
3. Check the appropriate option under the Warning Tone heading.
 - To keep the factory-set option and provide a warning tone to indicate that the extension is being monitored, check the Yes box.
 - If a warning tone will not be provided when an extension is being monitored, check the No box.
4. Write the extension number for each group member in the Member Ext. No. column.
5. Write each Service Observing group member's name in the Member Name column.

Operator Features

Operator features apply only to DLCs, QCCs, and any Direct Station Selectors (DSSs) connected to them.

Forms Needed

- 2a, System Numbering: Extension Jacks
- 2d, System Numbering: Special Renumbers
- 5d, Queued Call Console (QCC)
- 6a, Optional Operator Features

Direct-Line Console

Use these instructions only if the system has one or more DLCs. Otherwise, skip to the section, "[Queued Call Console \(Hybrid/PBX Mode Only\)](#)." This section contains instructions for the Operator Hold Timer and DLC Automatic Hold features.

Operator Hold Timer

This section contains instructions to set the operator hold timer to track the number of seconds callers are on hold for an operator. When a caller is on hold longer than the number of seconds programmed for the timer, the operator is reminded of the call by a single ring.

Planning Form Instructions

Under the Operator Hold Timer heading on Form 6a, do *either* of the following:

- To keep the factory setting, check 60 Seconds.
- To change the factory setting, check the second box and write the number of seconds (10 to 255 seconds) in the space provided.

DLC Automatic Hold

This section contains instructions to set DLC Automatic Hold to place calls on hold automatically when the operator presses another line button.

Planning Form Instructions

Under the DLC Automatic Hold heading on Form 6a, do *either* of the following:

- To keep the factory setting (no DLC Automatic Hold), check the Disable box.

- To automatically put calls on hold when another line button is pressed, check the Enable box.

If the system includes one or more QCCs, proceed to the next section. Otherwise, skip to the section, "[Direct Station Selector](#)."

Queued Call Console (Hybrid/PBX Mode Only)

Use these instructions only if the system has one or more QCCs. Otherwise, skip to the section, "[Direct Station Selector](#)."

This section contains instructions to set the following QCC operator features:

- Hold Return
- Automatic Hold or Release
- Calls-in-Queue Alert
- Queue Over Threshold
- Elevate Priority
- Message Center Operation
- Automatic or Manual Directed Call Completion
- Return Ring
- Position-Busy Backup
- Operator Hold Timer
- Call Types
- Voice Announce

Hold Return

This section contains instructions to specify whether calls put on hold by a QCC operator stay on hold indefinitely, or are returned to the QCC queue after the Hold Timer has expired twice.

Planning Form Instructions

Under the Hold Return heading on Form 6a, do *either* of the following:

- To indicate that calls stay on hold after the hold timer has expired twice, check the Remain on Hold (factory setting) box.
- To indicate that calls on hold return to the QCC queue after the hold timer has expired twice, check the Return to Queue box.

Automatic Hold or Release

This section contains instructions to specify whether a call that is in progress on a Call button is automatically put on hold (Automatic Hold) or disconnected (Automatic Release), when the operator presses another Call button.

Planning Form Instructions

Under the Automatic Hold or Release heading on Form 6a, do *either* of the following:

- To specify that calls are automatically disconnected, check the Automatic Release box (factory setting).
- To specify that calls are automatically put on hold when another Call button is pressed, check the Automatic Hold box.

Calls-in-Queue Alert

This section contains instructions for setting the Calls-in-Queue Alert option to notify QCC operators (with a single beep) when a new call enters the QCC queue.

Planning Form Instructions

Under the Calls-in-Queue Alert heading on Form 6a, do *either* of the following:

- To keep the factory setting (QCC operators are *not* notified when calls are waiting in queue), check the Disable box.
- To specify that particular QCC operators are notified (with a single beep) when a call enters the queue, check the Enable box and, in the space provided, write the extension number of each QCC position that receives the notification (see Form 2a or Form 5d).

Queue Over Threshold

This section contains instructions to specify the maximum number of calls allowed in the QCC queue before operators are notified (with a tone through the receiver or headset) that calls are waiting.

Planning Form Instructions

Under the Queue Over Threshold heading on Form 6a, do *either* of the following:

- To keep the factory setting (operators are not notified), check the 0 Calls box.
- To indicate that operators are notified when calls are waiting in the queue, check the second box and write the maximum number of calls in the queue before notification (any number from 1 through 99) in the space provided.

Elevate Priority

This section contains instructions to arrange the QCC queue so that important business calls are answered first.



NOTE:

During high-volume calling periods this means that only high-priority calls are delivered to a QCC within a reasonable amount of time, and low-priority calls go unanswered. To review call priority assignments, see [“QCC Queue Priority Level \(Hybrid/PBX Mode Only\)”](#) in [Chapter 3, “Lines/Trunks.”](#)

The setting for the Elevate Priority option determines the length of time (in seconds) before the calls waiting in the QCC queue are automatically assigned a higher level of priority. Although the priority of every call in the queue is then increased to a higher level, a call is never increased to the highest priority (1) because priority 1 calls are those that must reach the operator as quickly as possible.

Planning Form Instructions

Under the Elevate Priority heading on Form 6a, do *either* of the following:

- To indicate that the order of priority is not changed, check the 0 Seconds box (the factory setting).
- To indicate that call priority is reordered, check the second box and write the number of seconds in the space provided. Select any number from 5 through 30 depending on the number of priority levels assigned to calls ringing into the queue and the volume of incoming calls. (The recommendation for typical systems is 8 seconds.)

Message Center

This section contains instructions to assign this feature when there is more than one QCC operator position and the customer wants one centralized location where employees retrieve messages. Usually only one message center position is necessary, but there can be several QCCs in one room sharing messaging duties.

The Message Center option allows you to designate a QCC as a message center with the following options automatically set:

- The only incoming calls that go to the message center QCC are calls to the extension number of the QCC and calls sent to the QCC using Forward or Follow Me.
- Returning calls (such as those sent to an extension, operator-parked, and camp-on calls) go to the message center QCC. This means that the message center position is different from that of the system operator who originally answered the call.

- Group Coverage calls go to the QCC message center.
- DID calls to invalid destinations (unassigned extension numbers) go to the QCC message center.

Planning Form Instructions

Under the Message Center heading on Form 6a, do *either* of the following:

- To indicate that no message center operator is assigned, check the No box.
- To assign a message center, check the second box and write the extension of the QCC operator position in the space provided (see Form 2a or 5d).

Directed Call Completion

Use these instructions only if the system has a QCC with a Direct Station Selector (DSS). Otherwise, skip to the next section, "[Return Ring](#)."

This section contains instructions for changing the factory setting for Directed Call Completion from Automatic to Manual (that is, the QCC operator must press the Release button when using a DSS button to direct a call).



NOTE:

If the QCC operator uses the DSS to transfer calls across a private network, the operator may want to use manual completion to avoid transfer without return to busy. If you subscribe to ANI or ICLID and automatic completion is selected, the ANI and ICLID information will be sent but calls will not return on busy.

Planning Form Instructions

Under the Extended Call Completion heading on Form 6a, do *either* of the following:

- To keep the factory setting, check the Automatic completion box.
- To require the operator to use the Release button to direct calls, check the Manual completion box.

Return Ring

This section contains instructions to specify the number of rings before an unanswered call is returned from the extension where it was sent to the QCC queue (or QCC message center position).

If the system includes a voice mail system, you should increase this number to ensure that the voice mail system gets the call before it is returned.

Planning Form Instructions

Under the Return Ring heading on Form 6a, do *either* of the following:

- To keep the factory setting, check the 4 Rings box.
- To change the factory setting, check the second box and write the number of rings you want to assign in the space provided (1–15 rings).

Position-Busy Backup

This section contains instructions to assign another telephone to receive calls when all QCC operator consoles are in a position-busy state. Only a calling group can be assigned as a backup for a QCC operator position. If a backup is not designated, the system does not allow the last available operator position to go into the position-busy state.

Planning Form Instructions

Under the Backup On heading on Form 6a, do *either* of the following:

- To indicate that no backup is assigned, check the No box (factory setting).
- To designate a backup, check the second box. The extension number of the backup calling group will be completed later.

Operator Hold Timer

This section contains instructions to set the system to track the number of seconds that callers are on hold at an operator console. When a caller is on hold longer than the number of seconds programmed for the timer, the operator is reminded by a single ring.

Planning Form Instructions

Under the Operator Hold Timer heading on Form 6a, do *either* of the following:

- To keep the factory setting, check the 60 Seconds box (factory setting).
- To change the factory setting, check the second box and write the number of seconds (from 10 to 255 seconds) in the space provided.

Call Types

This section contains instructions to assign a QCC operator to receive certain types of calls and to set the QCC queue priority level.

Planning Form Instructions

The Group Coverage Calls section on the back of Form 6a will be completed later in this chapter.

Under the Call Types heading on Form 6a (page 2):

1. In the QCC Operator to Receive Calls column, for each call type, do *either* of the following:
 - If QCC operators are not to receive the call type, write **None**.
 - If one or more QCC operators are to receive the call type, write any combination of the extension number or numbers. See Form 2a or 5d.



NOTE:

You cannot assign an operator to either Follow Me calls or calls to QCC operator extensions.

2. In the QCC Queue Priority Level column, write the level for each call type. Assign a value of 1 (high priority) through 7 (low priority). The factory setting is 4.

Voice Announce

This section contains instructions to enable a QCC operator to originate Voice Announce (VA) calls. When enabled, the Call 5 button on the QCC can originate Voice Announce calls.



NOTE:

QCCs cannot receive Voice Announce calls.

Planning Form Instructions

Under the Voice Announce heading on Form 6a, do *either* of the following:

- To prevent QCC operators from originating Voice Announce calls, check the Disable box (factory setting).
- To allow QCC operators to originate Voice Announce calls, check the Enable box.

Direct Station Selector

Use these instructions only if the system has Direct Station Selectors (DSSs) connected to MLX operator consoles. Otherwise, skip to the section, [“Group-Assigned Features.”](#)

This section contains instructions for recording the range of extensions assigned to the Page buttons, and for renumbering the extensions for Park, so that the extensions fall within the Page button ranges.

DSS Page Buttons

This section contains instructions for recording the range of extensions assigned to each of three Page buttons. The three Page buttons should be set to reach ranges of numbers that include the extension numbers in the extension numbering plan (including non-local extensions if the system is in a private network configuration) and reflect the number of extensions available:

- If one DSS is connected to an operator console, set each Page button for a range of 50 numbers (matching the 50 available extensions).
- If two DSSs are connected, set each Page button for a range of 100 numbers. The Page buttons then control 100 extensions, 50 on each DSS.



NOTE:

If two DSSs are used, the Page buttons on the second DSS are not active.

Planning Form Instructions

In the Page Buttons table under the Direct Station Selector heading of Form 6a (page 1), write the beginning extension for the range of the 50 or 100 extension numbers for each Page button. Assign the lowest extension numbers in the plan to the first Page button, the middle range of numbers to the second Page button, and the highest extension numbers to the third Page button. (Use the information from Form 2a, System Numbering: Extension Jacks to assign the range of extensions for each Page button.) Also, record this information on Form 2d under the DSS Page Buttons heading.

Park Zones

This section contains instructions to enable operators with a DSS to have one-touch use of Park. The system automatically reserves eight extensions (881–888) for system operator park zones; only system operators can use these park zone extensions to park calls. Consider changing these factory-set extensions to numbers that fall within the Page button ranges. The same considerations apply as those used during reassignment of extension numbers.

Planning Form Instructions

In the Call Park Codes table under Direct Station Selector on Form 6a:

- Write the new Zone numbers assigned in the Renumber to columns.
- On Form 2d, System Numbering: Special Renumbers, write the new numbers in the Renumber to column of the Park Zone section.

Group-Assigned Features

The system offers the following features to facilitate the call-handling responsibilities of groups of users:

- Call Pickup Groups
- Group Paging
- Coverage
- Group Calling

This section contains instructions for recording information about these features.

To determine whether any of the group-assigned features are appropriate for system users, see the analysis of the Employee Communication Survey.

Forms Needed

- 2a, System Numbering: Extension Jacks
- 2d, System Numbering: Special Renumbers
- 4b, Analog Multiline Telephone
- 4d, MLX Telephone
- 4h, ETR Telephone
- 4j, MLS Telephone
- 5a, Direct-Line Console (DLC): Analog
- 5b, Direct-Line Console (DLC): Digital
- 6a, Optional Operator Features
- 7a, Call Pickup Groups
- 7b, Group Paging
- 7c, Group Coverage
- 7d, Group Calling

Call Pickup Groups

This section contains instructions for assigning this feature to employees who work in a common area and who do not have a support person for coverage. You can assign up to 30 call pickup groups with up to 15 telephones for each group. Each telephone can be assigned to only one group.



NOTE:

This feature is similar to the Coverage feature presented later in this chapter. Compare these features before choosing the appropriate feature for the system.

Planning Form Instructions

1. Form 7a holds the programming information for eight Call Pickup groups. Make additional copies of the form if more groups are planned. Review the analysis of question 10 on the Employee Communication Survey, and determine the number of call pickup groups needed (maximum of 30).
2. For each group, write the group number in the Group Number space. Start with 1 and number the groups sequentially.
3. Write the name of a group, such as Customer Service, in the Group ID space (see the survey analysis).
4. Write the extension number for each group member in the Ext. No. column (see Form 2a).
5. Write each group member's name or location in the Person or Location column (see Form 2a).

Group Paging

This section contains instructions for setting the system to allow users to make voice announcements that are heard by a particular group of employees with speakerphones or by everyone who has a speakerphone.

You can assign six paging groups of selected employees, such as secretarial pools, committee members, or departments, who need to hear announcements. Each group can have as many as 10 extension numbers.

The seventh paging group is factory-set to page all extension numbers. This group is useful if the system does not have a loudspeaker paging system.

The system automatically reserves extension numbers 793–799 for paging groups. Extension 799 is the Page All group. Decide whether to keep or to reassign the factory-set extension numbers. Keep in mind that you can provide one-touch use of Group Paging to operators with DSSs if you renumber to extensions within the Page 1, 2, or 3 button ranges or set the Page 1, 2, or 3 buttons so the operators can access them.

Planning Form Instructions

1. Determine the number of paging groups needed.
2. For each group, write the name of the group, such as *Sales*, in the Group ID space on Form 7b.
3. To change the factory-set extension numbers:
 - a. Write the new numbers in the Renumber to space.
 - b. On Form 2d, System Numbering: Special Renumbers, write the new numbers in the Renumber to column of the Group Paging section of that form.
4. Write the extension number for each group member in the Ext. No. column (see Form 2a).
5. Write each group member's name or location in the Person or Location column (see Form 2a).

Coverage

Coverage allows calls to extensions (called *senders*) to be covered by one or more alternate extensions (called *receivers*). Coverage can be individual or group-assigned. This section contains instructions for both types. See [“Calling Restrictions”](#) earlier in this chapter for more information.

Forms Needed

- 2a, System Numbering: Extension Jacks
- 4b, Analog Multiline Telephone
- 4d, MLX Telephone
- 4h, ETR Telephone
- 4j, MLS Telephone
- 5a, Direct-Line Console (DLC): Analog
- 5b, Direct-Line Console (DLC): Digital
- 6a, Optional Operator Features
- 8a, System Features

Individual Coverage

This section contains instructions to allow an arrangement in which calls from one sender are covered by one or more receivers. A receiver can provide primary Individual Coverage or secondary Individual Coverage.

A sender can have calls covered by up to eight receivers, and a receiver (such as a secretary) can provide Individual Coverage for more than one sender (up to eight buttons on one receiver telephone). Any type of telephone can be a sender; only a multiline telephone with programmable buttons available can be a receiver. The receiver must have a programmed Cover button for each sender whose calls are being covered.



NOTE:

See "Coverage" in the *Feature Reference* for additional information.

Calls on lines programmed for No Ring cannot be covered.

If a principal user is assigned, calls that would be sent to Group Coverage are sent only to the principal's Group Coverage receivers. If the principal user has Remote Call Forwarding on, calls are sent to an outside number rather than to the coverage receivers.

Planning Form Instructions

1. Review the Employee Communication Survey analysis and determine which users (senders) need Individual Coverage.



NOTE:

Single-line telephones cannot be receivers, and QCCs cannot be senders or receivers.

2. On the appropriate form for each receiver telephone (Form 4b, 4d, 4f, 4g, 4h, 5a, or 5b), locate an available button on the Button Diagram and write **Ind Cover** and the sender's extension number. Write **P** to indicate primary or **S** to indicate secondary Individual Coverage.

Group Coverage

In Group Coverage, senders are organized into groups, and calls received by any member of the group are sent to a receiver.

Any type of telephone (excluding QCCs) can be a member of a coverage group; however, no individual sender can be a member of more than one group. A maximum of 32 coverage groups can be set up, and there is no limit to the number of senders in each group. Three types of receivers can be programmed: calling groups, or the QCC queue and/or multiline telephones.



NOTE:

Group Coverage can be used alone or can be set up to work with either primary or secondary Individual Coverage, or both. This allows callers to get personal attention from the primary and/or secondary Individual Coverage receiver and backup from Group Coverage. For example, a receiver such as a secretary can have a Primary Cover button to provide Individual Coverage for a sender who is also a member of a coverage group.

Planning Form Instructions

1. Form 7c holds information for eight coverage groups. Make additional copies of the form if more groups are planned. Review the Employee Communication Survey analysis and determine the senders to be grouped.
2. Form 8a is used to identify system features. Under the Coverage Delay Interval heading at the top of Form 8a, do *either* of the following:
 - To keep the factory-set interval, check the 3 rings box.
 - To change the factory-set interval, check the second box and write the number of rings (1–9) in the space provided.
3. Under the Delay Ring Interval heading (Release 4.0 and earlier systems only), do *either* of the following:
 - To keep the factory-set interval, check the 2 rings box.
 - To change the factory-set interval, check the second box and write the number of rings (1–6) in the space provided.

4 Features

Group-Assigned Features

4-29

4. On Form 7c:

- a. Write the group number in the Group No. space. Start with 1 and number the groups sequentially.



NOTE:

If a group is the coverage group for AUDIX Voice Power¹ (the factory setting is Group No. 30 but can be changed), write AUDIX by the group number and list the extensions of AUDIX Voice Power subscribers (see Form 2a).

- b. List the extension numbers of all senders in the group in the upper block (see Form 2a).
- c. List the receivers for the group in the lower block by doing one of the following:



NOTES:

- If you have not yet created calling groups, you must defer naming them as receivers until later.
 - If the system includes a voice mail system, see that system's documentation for completing the receivers. In addition, if the system is part of a private network with Centralized Voice Messaging, see the *Network Reference*.
 - Designate a calling group as a receiver by checking the Calling Group box (see Form 7d).
 - Designate the QCC queue as a receiver (Hybrid/PBX mode only) by checking the QCC Queue box and/or listing the extension numbers of all receivers (maximum of eight).
5. On each copy of Forms 4b, 4d, 4f, 4h, 4j, 5a, and 5b that describes a specific receiver:
 - a. Locate an available button on the Button Diagram.
 - b. Write *Group Cover* and the coverage group number in the space available.
 6. If designating the QCC Queue as a receiver (Hybrid/PBX mode only), on the Group Coverage Calls table on Form 6a (page 2):
 - a. Write the extension or extensions for the QCC operator position or positions to receive the calls in the QCC Operator to Receive Calls column (see Form 2a).
 - b. Write the priority level for each coverage group's calls in the QCC Queue Priority Level column. Assign a value of 1 (highest) through 7 (lowest); the factory setting is 4.

1 Can no longer be ordered.

Group Calling

This section contains instructions to group the telephones of people (such as ticketing agents) who handle the same type of call. Through the Group Calling feature, all telephones in the group are assigned to a single extension number that is used by both inside and outside callers to reach the group. The individual extension numbers of the telephones are still used by callers who need to reach a specific member of the calling group.



NOTES:

- The Extension Status feature must be set for the Group Calling/CMS configuration (which is the factory setting) in order for calling groups to be available. See the [“Extension Status”](#) instructions later in this chapter for details.
- In Release 6.1 and later, one non-local member may be in a calling group. A calling group cannot contain both local and non-local members. See the *Network Reference* for information.
- If calling groups are to be used in conjunction with Centralized Voice Messaging, see the *Network Reference* for information.

The system automatically reserves extension numbers 770–791 and 7920–7929 for calling groups (these may be changed). If operators with DSSs need one-touch Group Calling, renumber the extensions that fall within the Page button ranges.

If the system has AUDIX Voice Power/Fax Attendant System¹, certain extension numbers are reserved as follows:

7924	Fax Response
7925	Voice Mail
7926	Call Answer
7927	Information Service
7928	Message Drop
770	Automated Attendant

Calling groups can be part of the group assignment for Night Service, as described later in this chapter.

¹ Can no longer be ordered.

Planning Form Instructions

1. Review the Employee Communication Survey analysis and determine the number of calling groups needed, using the following guidelines:
 - Assign up to 32 calling groups with up to 20 members for each group. Each telephone user can be a member of only one calling group.
 - Designate up to 80 lines/trunks to ring directly into a calling group. Incoming calls on a given line/trunk can be directed to only one calling group.
 - If the MERLIN LEGEND Mail or other supported VMS is being used, either on the local system or a remote system (Centralized Voice Messaging), reserve one or more calling groups for that feature.
 - A calling group may have up to one non-local member (Release 6.1 and later). If a calling group has a non-local member, that is the only member allowed in the calling group. Local and non-local members cannot be in the same calling group. A calling group containing a single non-local member can be used for the same purposes as a calling group containing only local extensions. This includes night service, group coverage, calling group overflow coverage, and QCC queue overflow coverage across a private network to a centralized VMS/AA, non-local calling group, QCC queue, DLC, or any individual extension on a remote MERLIN LEGEND, DEFINITY ECS, or DEFINITY Prologix system, or to the PSTN via UDP routing.
2. For each calling group, make a copy of both sides of Form 7d, Group Calling.
3. For each group, on the front of Form 7d, list the extensions and lines/trunks assigned to the group:
 - a. Write the group number in the Group No. space. Start with 1 and number sequentially.
 - b. Write the name of the group in the Group Name space. See the survey analysis.

NOTE:

If the system has MERLIN LEGEND Mail or other supported VMS, fill in only the group number and group name here, then fill in the rest of the Group Calling information on the applicable forms for that VMS.

4 Features

Group-Assigned Features

4-32

- c. Do *either* of the following:
 - To use a factory-set extension number, write the number in the space provided (770 for group 1, 771 for group 2, and so on).
 - To change a factory-set extension number, write the new number in the Renumber to space, and then on Form 2d, System Renumbering: Special Renumbers, write the group name in the Group ID Label column (up to 7 characters), and the new number in the Renumber to column of the Group Calling section of that form.



NOTE:

Before you complete the extension number and name entries in [Step 4](#), read [Step 2 on page 4-36](#) of the instructions in the next section, "[Calling Group Options](#)."

4. In the Extensions section of Form 7d, write the extension number of each member of the group in the Ext. No. column and the name of the person or location in the Person or Location column (see Form 2a).
5. In the Trunks/Pools table of Form 7d, for each line/trunk that is to ring directly into the calling group, write the line/trunk or pool number (see Form 2c).



NOTES:

- When a pool is assigned to a calling group, all lines/trunks in the pool are assigned to the group. Individual trunks within the pool cannot be assigned to a calling group.
 - If a pool contains any dial-in trunks (such as DID trunks), the pool cannot be assigned to a calling group. Also, pools with private network tandem trunks should not be assigned to calling groups.
 - Pools may be assigned to only one calling group.
 - Lines/trunks assigned as the system Music-On-Hold or External Page Port cannot be assigned to a calling group.
 - Before adding to a calling group, you must first remove lines/trunks from the QCC.
6. If assigning a calling group as backup for a QCC, under the Position Busy Backup heading in the Queued Call Console section of Form 6a, Optional Operator Features, check Yes and write the extension number of the calling group.
 7. To record information for another calling group, repeat this procedure beginning with Step 3; use a blank Form 7d for each group.

Calling Group Options

This section contains instructions for the following calling group options:

- Hunt Type
- Primary and Secondary Delay Announcements
- Message-Waiting Receiver
- Calls-in-Queue Alarm Thresholds
- External Alert for Calls-in-Queue Alarm
- Overflow Coverage
- Overflow Threshold
- Overflow Threshold Time
- Prompt-Based Overflow (Release 6.0 and later only)
- Group Type
- Queue Control (Release 6.0 and later only)
- Priority Call Queuing

The order in which the system searches for available calling group members for subsequent calls can be *circular*, *linear*, or according to which agent is *most idle* (Release 5.0 or later) and is called the *hunt type*. The Circular setting searches for an available calling group member starting with the extension after the last extension to receive a call. The Linear setting distributes calls starting with the first extension assigned to the group through system programming. The Most Idle setting distributes calls according to the most-idle queue. For some applications, this hunt type is more efficient than the circular method, because it takes into account the varying duration of calls.

Up to 10 primary and one secondary delay announcement devices can be designated for each calling group; more than one calling group can use the same announcement devices. The announcement devices should not be assigned as group members, and they are outward-restricted to prevent unauthorized calls.

Each calling group can have only one telephone assigned as its message-waiting receiver. The same telephone can be assigned as the message-waiting receiver for more than one calling group.

Three Calls-in-Queue Alarm thresholds can be set to more clearly indicate the real-time status of the calls waiting in the queue according to the behavior of programmed Calls-in-Queue Alarm buttons. In Release 4.2 and earlier, only one Calls-in-Queue Alarm Threshold setting is available to activate the LEDs at programmed Calls-in-Queue Alarm buttons for a calling group.

4 Features

Group-Assigned Features

4-34

Using all three levels, the system manager sets Threshold 3 to the highest value, Threshold 2 to a middle value, and Threshold 1 to the lowest value. A Calls-in-Queue Alarm button indicates the severity of the alarm conditions in the following ways:

- If the number of waiting calls is less than the value programmed for Threshold 1, or drops below that level, the LED is unlit.
- If the number of waiting calls is greater than or equal to the Threshold 1 value but less than the Threshold 2 value, the LED flashes.
- If the number of waiting calls is greater than or equal to the Threshold 2 value but less than the value for Threshold 3, the LED winks.
- If the number of waiting calls is greater than or equal to the highest value, Threshold 3, the LED lights steadily.

If all three thresholds are set to the same value, the result is one threshold only with LED state either off or on (steady). If two values are the same, then the result is two alarm levels (flash, steady). The factory setting is one call for all three thresholds with LED states of off and steady.

In Release 5.0 and later systems, the primary delay announcements function like the single announcement available in prior releases. After the delay announcement (the primary delay announcement in Release 5.0 and later systems), an inside caller hears a special ringback, a transferred inside caller hears regular ringback, and an outside caller (including a transferred outside caller) hears special ringback or Music-On-Hold, if programmed, until the call is answered by a calling group member. The delay announcement or primary delay announcement is played only once while the call is in queue.

In Release 5.0 and later systems, the system manager can specify the extension for an optional secondary delay announcement and use system programming to set the interval (0–900 seconds) between announcements. This setting determines the time before a waiting caller hears the secondary announcement or, if it is set to repeat, the interval between replays of the secondary announcement. The secondary announcement can either repeat or play only once, after which the caller hears ringback or Music-On-Hold, according to the rules outlined above. The primary and secondary announcement options, when used together, allow the system manager to issue an initial message to callers, followed by a repeating announcement that, for example, urges the caller to stay on the line and wait for a calling group member.

The external alert, designated as a calls-in-queue alarm, can be any alerting device connected through an MFM in the External Alert mode for MLX telephones. That alert is tied to the third threshold value. The alert stays on as long as the threshold is exceeded. Only one external alert can be designated for each calling group. Since the signal is continuous, you should only use lighted external alerting devices. An alert connected to a Supplemental Alert Adapter for an analog multiline telephone should not be used as a calls-in-queue alarm.

4 Features

Group-Assigned Features

4-35

The Overflow Threshold determines the maximum number of calls (1–99) waiting in the calling group queue before being sent to the Overflow receiver. The Overflow Threshold Time determines the maximum amount of time that any call waits in the queue before being sent to the Overflow receiver. The Overflow Threshold should be set to a number larger than the third Calls-in-Queue Alarm Threshold to ensure that the Calls-in-Queue Alarm will alert before calls are sent to the Overflow receiver. If the Overflow Threshold Time is the primary source for overflow, set the Overflow Threshold to a large number of calls (for example, 99 calls). If you want calls to overflow based on the number of calls in the queue, disable the Overflow Threshold Time by setting it to 0 seconds.

In Release 6.0 and later systems, Prompt-Based Overflow allows callers waiting in the queue, and listening to delay announcements, to press the pound key (#) in order to reach the overflow receiver for the group (which may be the QCC queue to another calling group, including a calling group assigned for a voice mail system).



NOTE:

One TTR is allocated while the announcement unit is playing the message if Prompt-Based Overflow is enabled for a group.

In Release 6.0 and later systems, the system manager can control the number of calls allowed into the primary calling group queue. Subsequent callers will receive a busy signal as long as the call was received on the following types of lines/trunks: DID, PRI facilities programmed for dial-plan routing, and all calls that are transferred from a VMI port to a local extension.



NOTE:

Remote Access calls to a calling group, coverage calls directed to a calling group, and calls directed to a calling group through a QCC Position-Busy backup are not eligible for queue control.

In Release 7.0 and later systems, a calling group can be assigned a priority level and can be used to support another calling group. This feature is called Priority Queuing. When a calling group is assigned as a *Support calling group* to another calling group (called the *Home calling group*), it answers calls coming into the Home calling group when no Home calling group agents are available. Depending on its priority level, the Support calling group answers its own calls or the Home calling group's calls first.

For example, if the Home calling group has a priority of 3, the Support calling group has a priority of 5, and no Home calling group members are available, the Support calling group answers all of the Home calling group's calls before it answers its own calls. If the Support calling group's priority is higher than that of the Home calling group, the Support calling group answers all of its own calls first.

Each Home calling group can have only one Support calling group. A Support calling group, however, can serve up to 31 Home calling groups.

Planning Form Instructions

For each calling group:

1. On Form 7d (page 2), copy the Group No., ID, and extension number from the front of the form.
2. Select the Hunt Type by doing *one* of the following:
 - To keep the factory-set hunting pattern, check the Circular box.

NOTE:

If you choose a Linear hunt, be sure you have listed the extension numbers and names in the Extensions section on Form 7d (page 1), in the order that you want the group searched. If you have not done this, go back and correct the front of the form so that the extensions are in the right order.

- To change the factory-set hunting pattern to Linear, check the Linear box.
 - To change the factory-set hunting pattern to Most-Idle, check the Most-Idle box.
3. Under the Primary Delay Announcement heading, do *one* of the following:
 - If there are no announcement devices, check the No box and proceed to Step 4.
 - To designate one or more announcement devices, check the second box and write the extension numbers for the devices in the space provided (see Form 2a or 2b).
 4. Under the Secondary Delay Announcement heading, do *one* of the following:
 - If there is no secondary announcement device, check the No box and proceed to Step 5.
 - To designate a secondary announcement device, check the second box and write the extension number for the device in the space provided (see Form 2a or 2b). Also do the following:
 - Write in the desired Delay Interval between the primary announcement and the secondary announcement in seconds. The Delay Interval is also the time between repeats of the Secondary Announcement, if the Repeat Announcement option is set.

 NOTE:

As a rule, the Delay Interval should never be set less than the length (in seconds) of the secondary announcement. Ideally, the Delay Interval should be a multiple of the secondary announcement's length, based on the anticipated number of calls in the queue. For example, if the secondary announcement length is 10 seconds and five calls are expected to be in the queue during busy times, then the Delay Interval should be 50 seconds. For more information on optimizing the settings for announcements, see the *Feature Reference*.

- If you want the secondary announcement to repeat continuously after the Announcement Delay Interval, then check the Yes box next to Repeat Announcement. Otherwise check the No box.
5. To designate a telephone to receive message-waiting indications for the group, do *either* of the following under the Message-Waiting Receiver heading on Form 7d (page 2):
 - To assign no receiver, check the No box.
 - To assign a receiver, check the second box and write the extension number of the message-waiting receiver (see Form 2a).
 6. Under the First Calls-in-Queue Alarm Threshold heading, do *either* of the following:
 - To keep the factory setting, check the 1 Call box.
 - To change the factory-set number of calls allowed in the queue before members are notified with a flashing LED, check the second box and write the number of calls (up to 99) in the space provided.
 7. Under the Second Calls-in-Queue Alarm Threshold heading, do *either* of the following:
 - To keep the factory setting, check the 1 Call box.
 - To change the factory-set number of calls allowed in the queue before members are notified with a winking LED, check the second box and write the number of calls (up to 99) in the space provided.
 8. Under the Third Calls-in-Queue Alarm Threshold heading, do *either* of the following:
 - To keep the factory setting, check the 1 Call box.
 - To change the factory-set number of calls allowed in the queue before members are notified with a steady LED, check the second box and write the number of calls (up to 99) in the space provided.

4 Features

Group-Assigned Features

4-38

9. Under the External Alert for Calls-in-Queue Alarm heading, do *either* of the following:
 - For no external alert for Calls-in-Queue Alarm, check the No box.
 - To designate an external alert when the Third Calls-in-Queue Alarm Threshold is exceeded, check the second box and write the extension number for the alert in the space provided (see Form 2b).
 10. Under the Priority Call Queuing heading, do *either* of the following:
 - For no priority call queuing, check the No box.
 - To designate priority call queuing, check the Yes box, and do the following:
 - Write the Home Group Priority Level (1-32) in the space provided. The factory setting is 16.
 - To designate a Support Group for the Home Group, write the Support Group extension number in the space provided. Also indicate the Support Group Priority Level in the space provided.
-  **NOTE:**
You assign a priority level to a calling group independent as to its status as a Home or Support Group. This is why the Support Group Priority Level is in parentheses.
11. Under the Overflow Coverage heading, do *one* of the following:
 - For no overflow coverage, check the No box.
 - To designate overflow coverage by another calling group, check the second box and write the calling group number of the overflow calling group in the space provided.
 - To designate that overflow coverage will be provided by QCC operators, check the third box and write the QCC LDN (queue) extension number in the space provided.
 12. Under the Overflow Threshold heading, do *either* of the following:
 - To keep the factory setting, check the 1 call box.
 - To change the threshold, check the second box and write the number of calls (up to 99) in the space provided.
 13. Under the Overflow Threshold Time heading, do *either* of the following:
 - To keep the factory setting and disable the Overflow Threshold Time, check the 0 Seconds box.
 - To change the threshold, check the second box and write the maximum number of seconds (1–900) calls wait in the queue in the space provided.

4 Features

Group-Assigned Features

4-39

14. Under the Prompt-Based Overflow heading, do *either* of the following:
 - To keep the factory setting and disable the Prompt-Based Overflow feature, check the Disabled box.
 - To enable Prompt-Based Overflow, check the Enabled box.
15. Under the Group Type heading, do *either* of the following:
 - To keep the factory setting of no automatic login, check the Auto Logout box.
 - To change the factory setting from Auto Logout, do *one* of the following:
 - Check the Auto Login box to indicate automatic login for an extension that should never be logged out, such as a data extension.
 - Check the Integrated VMI box to indicate automatic login for a VMS that requires special signaling for integrated operation.
 - Check the Generic VMI box to indicate automatic login for a VMS that does not require special signaling.
16. To specify the number of calls allowed into the group calling queue, under the Queue Control heading do *either* of the following:
 - To keep the factory setting, check the 99 Calls box.
 - To change the threshold, check the second box and write the number of calls (0–98) in the space provided.



NOTE:

Specifying a Queue Control threshold of 0 indicates that no calls are allowed into the queue (Queue Control is turned off).

Proceed to the next section, "[System Features.](#)"

System Features

System features affect all users and all or most telephones. For more information on system features, see the *Feature Reference*.

This section contains instructions for assigning the following system features:

- Transfer of calls
- Camp-On Return Time
- Call Park Return Time
- Automatic Callback
- Extension Status
- Station Message Detail Recording (SMDR)
- Inside Dial Tone
- Reminder Service Cancel
- Redirect Calls to Unassigned Extension Numbers
- Recall Timer
- Interdigit Timers
- Rotary-Dial Delay
- Allowed Lists
- Disallowed Lists
- Call Reservation Summary
- Night Service
- Labeling
- Automatic Route Selection (Hybrid/PBX Mode Only)

Forms Needed

- 3e, Automatic Route Selection Worksheet
- 3f, Automatic Route Selection Tables
- 3g, Automatic Route Selection Default and Special Numbers Tables
- 6e, Allowed Lists
- 6f, Disallowed Lists
- 6g, Call Restriction Assignments and Lists
- 8a, System Features
- 9a, Night Service: Group Assignment
- 9b, Night Service: Outward Restriction

- 9c, Night Service: Time Set
- 10a, Label Form: Posted Message
- 10b, System Speed Dial

Transfer Options

This section contains instructions for setting the following Transfer feature options to allow users to transfer outside or inside calls to another telephone:

- Transfer Return Interval
- One-Touch Transfer
- Transfer Audible
- Type of Transfer



NOTES:

- Transfer features, and any other feature that requires more than one SA button, can be disabled on Single-line telephones by removing all but one SA button through centralized programming. Refer to Form 4f, Tip/Ring Equipment.
- If customers with CTI applications will frequently use the Conference feature, set the system Transfer Type to Ring and not Voice. This will minimize the possibility of broadcasting a conference over an unattended speakerphone.
- If the DLC operator uses the DSS to transfer calls across a private network, the operator may want to use manual completion to avoid transfer without return to busy. If you subscribe to ANI or ICLID and automatic completion is selected, the ANI and ICLID information will be sent but calls will not return on busy.

Planning Form Instructions

1. Under the Return Time Interval heading in the Transfer Options section of Form 8a, do *one* of the following:
 - To keep the factory setting, check the 4 Rings box.
 - To indicate no return for transferred calls, check the 0 Rings box.
 - To change the factory-set number of rings, check the third box and write the number of rings (1–9) in the space provided.

2. Under the One-Touch Call Handling heading, do *either* of the following:
 - To keep the factory setting, check the One-Touch Transfer box and do *either* of the following:
 - Check the Automatic Completion box to keep the factory-set automatic completion of transfers.
 - Check the Manual Completion box to change the factory setting to manual completion.
 - To change from One-Touch Transfer to One-Touch Hold, check the One-Touch Hold box.
3. Under the Transfer Audible heading, do *either* of the following:



NOTE:

If programmed for Music-On-Hold and a music source is provided, outside callers who are transferred to a calling group, are waiting in the queue, or outside callers who are parked or camped-on, will hear music while they are waiting. If the system uses the Centrex Transfer via Remote Call Forwarding feature, it is recommended that Transfer Audible be set to Ringback.

- If the system should play music while callers are on hold for transfer, check the Music-On-Hold box.
 - If the system will not provide music, check the Ringback box.
4. Under the Type of Transfer heading, do *either* of the following:
 - For the system to select a Ring button for transferred calls, check the Ring Button box (factory setting).
 - For the system to select a Voice button for transferred calls, check the Voice Button box.

Camp-On Return Time

This section contains instructions for designating the number of seconds a caller waits when transferred to a busy extension by way of the Camp-On feature. If the telephone is still busy at the end of the programmed interval, the call returns to the person who transferred the call.

Planning Form Instructions

Under the Camp-On Return Time heading on Form 8a, do *either* of the following:

- To keep the factory-set interval, check the 90 Seconds box.
- To change the factory-set interval, check the second box and write the number of seconds (30–300) in the space provided.

Call Park Return Time

This section contains instructions for designating the number of seconds a caller waits when a person uses the Call Park feature to put a call on hold. If the call is not picked up at the end of the programmed interval, the call returns to the person who parked the call.

Planning Form Instructions

Under the Call Park Return Time heading on Form 8a, do *either* of the following:

- To keep the factory-set interval, check the 180 seconds box.
- To change the factory-set interval, check the second box and write the number of seconds (30–300) in the space provided.

Automatic Callback

This section contains instructions for setting the number of times the system should ring to alert a caller about a callback attempt. After the specified number of rings, the system abandons the callback attempt.

Planning Form Instructions

Under the Automatic Callback Interval heading on Form 8a, do *either* of the following:

- To keep the factory-set interval, check the 3 Rings box.
- To change the factory-set interval, check the second box and write the number of rings (1–6) in the space provided.

Extension Status

This section contains instructions to set Extension Status to allow an operator, a calling group supervisor, or a Call Management System (CMS) supervisor to determine the status of a telephone at a glance. The lights next to the buttons on a DSS or next to Auto Dial buttons programmed with extension numbers indicate the status of the telephone.

In Hotel mode, Extension Status (ES) affects an extension's calling restrictions. Only an ES operator can use a DSS to turn off states ES1 or ES2 to remove calling restrictions. In CMS mode, Extension Status does not affect calling restrictions.



NOTE:

In Hotel mode, an ES-restricted extension can call a remote private network extension.

Decide on the configuration and assign operator positions to monitor extension status.

Planning Form Instructions

Under the Extension Status heading on Form 8a:

1. Check the Assign to operator positions box and write the extension number for each operator position in the space provided. See the appropriate copy of Form 5a or 5b.
2. Do *either* of the following:
 - To keep the factory-set configuration, check the Group Calling/CMS box.
 - To change the configuration, check the Hotel box.

Station Message Detail Recording (SMDR)

Use these instructions only if connecting a Station Message Detail Recording (SMDR) device or call accounting application. Otherwise, skip to the next section, "[Inside Dial Tone](#)."

This section contains instructions for setting up SMDR to keep track of telephone usage. SMDR works in conjunction with the Call Accounting System (Intuity CAS, Windows CAS, IS CAS, CAS Plus V3, and MERLIN LEGEND Reporter) or a serial printer connected to the SMDR port on the control unit. The SMDR port is the upper RJ-45 jack on the processor module.

Two SMDR report formats are available: the factory-set Basic format or the ISDN format. The ISDN format is used when the business subscribes to ICLID or to the AT&T INFO2 automatic number identification service (ANI). When the system is set for ISDN format, the actual number dialed by the caller appears on the report. In a PRI private network, the ISDN format may be used to show the caller's telephone number. The rest of the fields are identical to the Basic format.

Two options, Calls Reported (non-UDP) and Calls Reported (UDP), determine what calls are included in the SMDR report. For calls that are not routed using the non-local dial plan, the options available are to report both incoming and outgoing calls (factory setting) or outgoing calls only. For calls that are routed using the non-local dial plan, the options available are to report both incoming and outgoing calls (factory setting) or none.

NOTES:

- For outgoing UDP calls, any call that involves the public network will be logged on the SMDR report regardless of the programmed setting of the UDP SMDR option. Examples of this type of call include DID calls that get routed over the private network, central office transfers from one switch to another in the private network, and UDP ARS calls.
- For incoming UDP calls, with the exception of UDP calling group calls, the call will not be logged unless the Calls Reported (UDP) option is set to Log Incoming/Outgoing. UDP calling group calls (a call made from

one switch in a private network to a calling group on another switch in the private network) will be logged regardless of the programmed setting of the UDP SMDR option if the Talk Time option is set to Enable.

The Talk Time option determines whether the SMDR report includes the talk-time duration in the Talk field. Talk-time duration is the amount of time a calling group agent spends on an incoming call. If SMDR is used with the MERLIN LEGEND Reporter, the Talk Time option must be enabled. If SMDR is used with CAS or a serial printer, the Talk Time option must be disabled.

MERLIN LEGEND Reporter and CAS will not operate concurrently.

If Talk Time is enabled, an asterisk (*) indicates an abandoned call. This occurs when the calling party disconnects a call being directed to an Auto Login or Auto Logout calling group before a member answers, even if the call was answered elsewhere in the system (unless the call is on a loop-start facility that does not have reliable disconnect supervision).

NOTES:

- For accurate reports, the system date must be set to the current date when the system is installed. Be sure you checked the Yes box on Form 1 under Set System Date.
- For systems where the majority of lines are PRI facilities, the SMDR Call Length should be programmed for one second.
- When SMDR is used with the MERLIN LEGEND Reporter, the settings for Call Length and Calls Reported have no effect on SMDR reporting for calling group calls.

Planning Form Instructions

In the SMDR Options section of Form 8a:

1. Under the Call Format heading, do *either* of the following:
 - To keep the factory-set format, check the Basic box.
 - To change the report format, check the ISDN box.
2. Under the Call Length heading, do *either* of the following:
 - To keep the factory-set call length, check the 40 Seconds box.
 - To change the factory-set call length, check the second box and write the number of seconds (0–255) in the space provided.

3. Under the Calls Reported (non-UDP) heading, do *either* of the following:
 - To keep the factory setting, check the Incoming and Outgoing box.
 - To change the factory setting, check the Outgoing Only box.
4. Under the Calls Reported (UDP) heading, do *either* of the following:
 - To keep the factory setting, check the Incoming and Outgoing box.
 - To change the factory setting, check the None box.
5. Under Talk Time heading, do *either* of the following:
 - To keep factory setting, check the Disable box.
 - To change the factory setting, check the Enable box.

Inside Dial Tone

This section contains instructions for specifying whether the system uses an inside dial tone that is different from or the same as outside line/trunk dial tone. The factory setting is for a different inside dial tone. How you set the system for dial tone is a matter of preference.



NOTE:

Regardless of how you set this option, VMSs receive outside dial tones. Some modems may require outside dial tone to dial out.

Planning Form Instructions

Under the Inside Dial Tone heading on Form 8a, do *either* of the following:

- To keep the factory-set system inside dial tone, check the Inside box.
- To change the dial tone to match the outside dial tone, check the Outside box.

Reminder Service Cancel

This section contains instructions for assigning a preset time when the system cancels all reminders.

Although all users can set and cancel reminder calls for their own telephones, and DLC system operators can set and cancel reminder calls for any telephone in the system, Reminder Service Cancel automatically cancels all reminder calls at the preset time, for example, at the end of the business day when all users have gone home and are not available to receive reminders.

Planning Form Instructions

Under the Reminder Service Cancel heading on Form 8a, do *either* of the following:

- To set no reminder service cancel time, check the No box.
- To set a time to cancel all reminders in the system, check the second box and write the time of day in the space provided.

Calls to Unassigned Extensions

This section contains instructions for designating that calls made to unassigned extension numbers by remote access users, or on DID or dial-in tie trunks are redirected to another extension number, the QCC queue, or a calling group instead of to the primary operator.



NOTE:

When an Automated Attendant transfers a call to a non-local extension, the transferring MERLIN LEGEND System monitors the call to ensure that it is answered. If the non-local extension is not available or the call is not answered within the transfer redirect timeout period (fixed at 32 seconds), the call stops ringing at the non-local destination and is redirected to the extension on the same system as the Automated Attendant that is programmed to receive redirected calls. This redirect extension can be a QCC queue, a calling group, or an individual extension.



SECURITY ALERT:

DID numbers that correspond to pool dial-out codes (or facility access codes) can be used to avoid toll restriction, leading to toll abuse and/or fraud. (See [Appendix A, "Customer Support Information"](#) for more information about security.)

Planning Form Instructions

Under the Calls to Unassigned Extensions heading on Form 8a, do *one* of the following:

- To keep the factory setting, check the Extension box.
- To change from the factory-set redirect to the primary operator, check *one* of the following:
 - To redirect calls to a QCC operator (Hybrid/PBX only), check the QCC queue box and write the extension number in the space provided (see Form 2a).
 - To redirect calls to another telephone, check the Extension box and write the extension number in the space provided (see Form 2a).
 - To redirect calls to a calling group, check the Calling Group box and write the calling group extension number in the space provided (see Form 7d).

Recall Timer

This section contains instructions for designating the length of the switchhook flash sent when Recall is used to disconnect a call and receive a new dial tone without hanging up. The interval of the switchhook flash and how Recall works depends on the type of telephone being used.

For multiline telephones, the factory setting is 450 ms. If users experience difficulty with Recall, the interval can be changed to a longer or shorter interval.

The single-line telephone Flash or Recall button transmits a timed switchhook flash of about half a second.

Planning Form Instructions

Under the Recall Timer heading on Form 8a, check *one* of the following:

- 350 ms
- 450 ms (factory setting)
- 650 ms
- 1 sec

Interdigit Timers

Programming for interdigit timers is reserved for Lucent Technologies technical support personnel or authorized dealers.

Interdigit timers are used by the MERLIN LEGEND System to determine when a user originating an outside call has completed dialing the digits. The information is necessary to allow the system to perform subsequent operations. You should not change the factory settings for interdigit timers unless instructed to do so by Lucent Technologies technical support or by an authorized dealer.

Rotary

This section contains instructions for designating whether dialed digits on rotary-dial lines/trunks are sent one by one as they are dialed or are stored and sent when dialing is completed.

Planning Form Instructions

Under the Rotary heading on Form 8a, check *either* of the following:

- To store digits and send them when dialing is completed, check the Delay (factory setting) box.
- To send digits out as they are dialed, check the No Delay box.

Allowed Lists



SECURITY ALERT:

If you assign a 0 (zero) as the first digit for any entry in an Allowed List, any toll restrictions assigned for calls to numbers that can be placed by local or toll operators are removed.

Use the instructions in this section and the next ([“Disallowed Lists”](#)) only if calling restrictions are assigned to any telephones. Otherwise, skip to the section, [“Night Service.”](#)

This section contains instructions to designate an Allowed List of telephone numbers that a restricted telephone can dial.

You can design up to eight lists, each with a maximum of 10 numbers. Each number can have up to six digits, for example, an area code followed by an exchange. If a toll-call prefix is required, you can include a leading 1, which the system doesn't count as one of the six digits. Star codes (such as *67) may also be included in the list to allow users to access special services offered by the central office. Once you have designed the lists, decide which restricted telephones have access to the lists. Each restricted telephone can have up to eight lists.



SECURITY ALERT:

In some instances, after dialing a star code, the central office responds with a second dial tone as a prompt to enter additional digits. If a caller begins dialing additional digits before the second dial tone, system restrictions may be bypassed and a restricted call may be routed. Careful administration of the Second Dial Tone Timer prevents the caller from bypassing call restrictions in this manner. Refer to the ["Planning Form Instructions"](#) that follow for information.

If foreign exchange (FX) or tie trunks are connected to the system, you can enter the exchange in the Allowed List to allow people with restricted telephones to dial numbers to the area code for the FX or tie trunk. As you design each list, consider which numbers need to be called by specific groups of restricted users. In a private network, restricted telephones can dial non-local UDP extensions. The non-local extension ranges do not need to be put on an Allowed List.

Planning Form Instructions

On Form 6e:

1. Write the name of the list in the space next to the list number.
2. Write the allowed area codes, exchanges, and/or star codes in the spaces provided (a maximum of 10 entries for each list).
3. If star codes are included in the Allowed List, the Second Dial Tone Timer must also be programmed. This timer induces a time delay before the user may dial additional digits after a star code, and is activated once a star code has been accepted. The dialing of any digits before this timer expires is treated as if normal restrictions have been violated and the call is not completed. The timer may be set from 0 to 5000 ms in increments of 200 ms. The factory setting is 0. On Form 1 (page 2), System Planning, write the desired setting for the Second Dial Tone Timer.
4. Write the extension numbers of the telephones that need access to the list in the Allow to Ext. Nos. column (see Form 2a).
5. If you planned Remote Access with restrictions and want to permit Allowed List numbers to be called by remote access users, then do the following:



NOTE:

Allowed List Class-of-Restriction assignments apply to all remote access users and cannot be assigned on an individual basis.

- a. On Form 3a (page 3), Incoming Trunks: Remote Access, in the Class of Restrictions without Barrier Codes section, write the list numbers under the Allowed List Access heading for either or both tie and non-tie trunks.
- b. On all copies of Form 3a (page 4), Class of Restriction with Barrier Codes, write the list numbers under the Allowed List Access heading for each barrier code assigned.

Disallowed Lists

This section contains instructions for using Disallowed Lists to prevent people from making calls to specific numbers, whether or not restrictions are specified for an extension and for Remote Access. You can use this feature instead of restricting telephones totally from making toll or local calls.



SECURITY ALERT:

Be sure to review the toll fraud information with regard to Disallowed Lists in [Appendix A, "Customer Support Information."](#)

Use a "wild card" character to indicate that you want calls to an exchange restricted in every area code. During system programming, a Pause (entered using the Hold button) indicates a wild card character; therefore, use the letter "p" to indicate on the form that a wild card character should be programmed.

You can design up to eight lists with a maximum of 10 numbers. Each number can have up to 11 digits—for example, a leading 1 (if a toll-call prefix is required for dialing) followed by the area code and telephone number. Star codes (such as *67) may also be included in the list to block users from accessing special services offered by the Central Office. Once you have designed the lists, decide which telephones to restrict. You can assign up to eight lists for each telephone.

Disallowed List 7 is the system default list and includes the numbers most frequently associated with fraud. The factory set entries for Disallowed List 7 are as follows: 0, 10, 11, 1809, 1700, 1900, 976, 1ppp976, and Q.



NOTES:

- Users cannot dial a number on an Allowed List if it matches a number on a Disallowed List assigned to the telephone.

- For a private network environment, see the *Network Reference* for planning Disallowed Lists needed to restrict calls across the private network.

Planning Form Instructions

On Form 6f:

1. Write the name of the list in the space next to the list number.
2. Write the disallowed area codes, exchanges, and/or star codes in the spaces provided (a maximum of 10 entries for each list). Use the wild card character ("p") to restrict an exchange from being dialed in any area code. For example, to prevent users from directly dialing the 976 exchange in any area code, write 1 p p 9 7 6.



NOTE:

On Form 6f (page 3), Disallowed List 7 contains factory set entries—that is, it is the factory set disallowed list. To change the entries in this list, cross out the entry and write the new values in the space provided.

3. Write the extension numbers of the telephones that you want to assign to the list in the Disallow to Ext. Nos. column (see Form 2a).
4. Disallowed List Class-of-Restriction assignments apply to all remote access users and cannot be assigned on an individual basis unless barrier codes are used. If barrier codes are used, Class-of-Restriction is assigned to individual barrier codes. Use Form 3a, Incoming Trunks: Remote Access, if you planned Remote Access and want to restrict callers through Disallowed Lists. For a private network environment, see the *Network Reference* for planning Disallowed Lists needed to restrict calls across the private network:
 - a. On Form 3a (page 3), in the Class of Restriction without Barrier Codes section, write the list numbers under the Disallowed List Access heading for either or both tie and non-tie trunks.



SECURITY ALERT:

To help prevent toll fraud, barrier codes should always be required and should also be set to the maximum length allowed.

- b. On all copies of Form 3a (page 4), Class of Restriction with Barrier Codes, write the list numbers under the Disallowed List Access heading for each barrier code.

Call Restriction Summary

After the individual telephone forms have been completed, Form 6g, Call Restriction Assignments and Lists, can be used as a summary and telephone programming aid for telephone calling restrictions as designated in this chapter.

Planning Form Instructions

On Form 6g:

1. In the Ext. No. column, do *either* of the following:
 - Transfer the extension number from the individual telephone forms.
 - If copying from another extension, write the new extension number and then, in the Copy From column, write the extension from which calling restrictions for this extension will be copied.
2. In the Restriction Type column, check the appropriate column: Out for Outward Restriction, Toll for Toll Restriction, or No Rest. for No Restriction.
3. In the Allowed List No. and Disallowed List No. columns, write the appropriate list numbers from Forms 6e and 6f, respectively.
4. In the ARS Restriction Levels (FRL) column, write the Facility Restriction Level (FRL) value noted in the ARS Restriction Level heading on Form 6g.

Night Service

Use these instructions only if Night Service is used for after-hours telephone operation. Otherwise, skip to the section, "[Labeling](#)." This section contains instructions for selecting any combination of the following options for Night Service:

- Night Service with Group Assignment
- Night Service with Outward Restriction
- Night Service with Time Set

Night Service with Group Assignment

This section contains instructions for setting Night Service so that any call that comes to the operator console while Night Service is in effect rings immediately at each available telephone in a defined group and/or at a designated calling group. Calls ring immediately even on lines/trunks set for Delay Ring or No Ring.

You can create up to eight Night Service groups and/or Night Service calling groups, one for each operator. There is no limit to the number of telephones or outside lines assigned to each Night Service group, and each telephone or outside line can be assigned to more than one Night Service group.

A calling group can be the Night Service group for more than one operator, but only one calling group is allowed for each operator.

A DID call directed to a calling group will not receive Night Service treatment.

Private network calls will receive Night Service treatment.

Planning Form Instructions

In each column on Form 9a, Night Service: Group Assignment, do the following:

1. In the Operator Ext. No. space, write the extension number for the operator whose calls are being answered (see Form 2a for the extension number).
2. In the Trunk No. column, write the line/trunk number for each outside line that is a member of the Night Service group (see Form 2c for the line/trunk number).
3. In the Ext. or Calling Group No. column, write the extension number for each member of the Night Service group or for a calling group (see Form 2a for the extension number).
4. In the User or Calling Group Name column, write each Night Service group member's name or the name of the calling group (see Form 2a for the group number).

Night Service with Outward Restriction

This section contains instructions for setting Night Service so that only authorized users can place non-emergency calls when Night Service is in effect. This prevents unauthorized after-hours use of telephones.

Calls to non-local UDP extensions can be made even while Night Service restricted.

Calls to non-emergency numbers do not go through unless a password is entered first. You can include up to 10 telephone numbers on the Night Service Emergency List. If a HotLine extension dials an outside number, that telephone number should be on the Night Service Emergency List or the extension should be on the Exclusion List. Each number can have a maximum of 12 digits.

Once you specify that a password is required, the password applies to all telephones in the system when Night Service is activated at any operator position.

If users need to make after-hours calls and prefer not to enter a password, you can set up an Exclusion List that exempts those extensions from the password requirement. Extensions assigned to the Exclusion List keep the normal calling restrictions, if any are assigned, when Night Service is in effect. These extensions, however, are not protected in any other way from unauthorized after-hours use.

Planning Form Instructions

On Form 9b, Night Service: Outward Restriction:

1. The password must be 4 digits and can include the numbers 0–9 in any combination. To keep the password private, record it on a separate paper and not on the form.



SECURITY ALERT:

Additional steps must be taken to maintain security on ports (such as use of Disallowed Lists, Outward Restriction, and so on). Refer to [Appendix A](#), “[Customer Support Information](#),” for more information.

2. Write the numbers to be included in the Telephone No. list in the Emergency Allowed List section.
3. To exclude users from the password requirement, complete the Exclusion List section.
 - a. In the Ext. No. column, write the extension number for each telephone (see Form 2a).
 - b. In the Name column, write each user’s name (see Form 2a).

Night Service with Time Set

This section contains instructions for setting the system to automatically turn Night Service on and off at the times and on the days of the week you specify. This ensures that after-hours calls are handled properly even if an operator forgets to turn on Night Service. Operators can still override the timer and turn Night Service on or off manually. The feature can also be deactivated through system programming for special conditions, such as a midweek holiday.

Planning Form Instructions

On Form 9c, Night Service: Time Set, write the time of day you want Night Service turned on (Start Time) and off (Stop Time) for each day of the week. Use 24-hour numbering, called military time—for example, 5:30 p.m. is 1730 in 24-hour numbering.

If Night Service is to remain on throughout the day, for example on Sunday, do not enter on and off times.

Night Service with Coverage Control

As of Release 4.1, Night Service Coverage Control automatically controls the status of programmed VMS Coverage Off buttons.

When the Coverage Control option is enabled, a transition into Night Service (either by pressing a Night Service button or automatically by the Time Set option) automatically deactivates the VMS Coverage Off (Release 2.0 or later) buttons (LED is off) and allows outside calls to go to VMS Coverage at night. When the system is taken out of Night Service (either by pressing a Night Service button or automatically by the Time Set option), programmed VMS Coverage Off buttons are activated (LED is on) and outside calls are prevented from going to VMS Coverage during the day.



NOTE:

Private network calls act like outside calls and do not go to voice mail when VMS Coverage Off is activated.

When the Coverage control option is disabled, Night Service status has no effect on programmed VMS Coverage Off buttons.

Planning Form Instructions

In the Coverage Control section of Form 9c, Night Service: Options, do *either* of the following:

- To keep the factory-setting of disabled, check the Disabled box.
- To change the factory-setting and enable the Coverage Control option, check the Enabled box.

Labeling

Labeling enhances the capability of display telephones used with the system.

The following types of labels appear on display telephones:

- Extensions and calling groups
- Posted Messages
- System Directory/System Speed Dial

Labels for extensions are described in [Chapter 2, "Control Unit Configuration,"](#) labels for lines/trunks are described in [Chapter 3, "Lines/Trunks,"](#) and labels for calling groups are described earlier in this chapter.

This section contains instructions for assigning labels for Posted Message and System Directory/System Speed Dial.

Posted Message

This section contains instructions for allowing users to post a message telling callers who have display telephones why they cannot answer.

There can be as many as 20 messages. Messages 1 through 10, shown on Form 10a, are already programmed in the system, and 10 more can be added, for a total of 20. In a Release 2.0 or later system, Messages 2 through 9 can be changed. In a Release 1.0 or 1.1 system, all 10 of the preprogrammed messages can be changed.

Planning Form Instructions

Posted messages can contain as many as 16 characters, including capital letters, numbers, ampersand (&), dash (-), space, colon (:), asterisk (*), and pound sign (#).

On Form 10a, Label Form: Posted Message, do *either* of the following:

- To add posted messages for Messages 11 through 20 (for example, CUSTM MSG 11) write each new message next to its message number (11 through 20) in the Revised Message column.
- To change existing messages, cross out the message and write the new message in the Revised Message column.



NOTE:

In Release 2.0 and later, Message 1, DO NOT DISTURB, cannot be changed.

System Speed Dial

This section contains instructions for designating systemwide, frequently used numbers. You can assign and store up to 130 three-digit System Speed Dial codes. To call one of these numbers, a caller presses the Feature button and dials a three-digit code.

Assign System Speed Dial codes to telephone numbers that shouldn't be displayed on telephones, such as access codes. Entries that do not display are referred to as Marked System Speed Dial entries. You can also assign labels to the System Speed Dial codes. These labels are listed in the System Directory so that MLX telephone users can search for them and dial System Speed Dial numbers with the touch of a button.

Planning Form Instructions



NOTE:

As a visual aid to distinguish lines during programming, every fourth line on the form is shaded.

1. Review the analysis of question 9 on the Employee Communication Survey.
2. On Form 10b, System Speed Dial:
 - a. Write the label (maximum: 11 characters) to be displayed for the number in the Name column.
 - b. Write each telephone number (maximum: 40 digits) in the Telephone Number column.
 - c. To display no number (Marked System Speed Dial entry), check the No box in the Display column (the factory setting is Yes).



NOTES:

- Marked System Speed Dial entries (entries that do not display) are not affected by the Second Dial Tone Timer setting. If the Central Office does not immediately supply dial tone when a star code is entered and a Marked System Speed Dial entry uses star codes, then the appropriate number of pauses (each 1.5 seconds) must be programmed in the entry following each star code.
- When a Marked System Speed Dial number (the dialed number is suppressed from the display) is used to dial a number, calling restrictions (such as toll or outward restrictions, or Allowed and Disallowed Lists) assigned to that extension are overridden. When an unmarked System Speed Dial or a Personal Speed Dial number is used to dial a restricted number, the call cannot be completed unless the number is on the Allowed List for that extension.

Automatic Route Selection (Hybrid/ PBX Mode Only)



SECURITY ALERT:

ARS should always be used for the best security protection.

This section contains instructions for using Automatic Route Selection (ARS) to allow the most cost-effective use of lines/trunks connected to the system, which can mean significant savings for the customer's business. Routing calls efficiently is especially important when the business has several different types of lines/trunks, such as local, WATS, FX, or tie, or uses more than one long-distance company. If the system is pooled, you can use ARS to specify which trunk pool should be used for each call, based on the telephone number the caller dials.

ARS tables can be used to route calls across a private network and out to the PSTN using a remote system's trunks. See the *Network Reference* for information on how to set up ARS for the private network.

With ARS, users must dial a 1 before dialing any 10-digit toll number, even if the local telephone company does not require a toll-call prefix.

You can define up to 16 ARS tables, each divided into two *subpatterns* based on the time of day. Four additional tables are factory-set and are designed to save programming time.

In this section, you define a set of ARS tables. This set includes a list of area codes and exchanges associated with each table, the preferred and alternate routes (if any) for each subpattern, and the Facility Restriction Level (FRL) for each route. As the system manager becomes more familiar with the calling patterns of the company and with the intricacies of ARS, he or she may want to change these patterns to suit the particular installation.

ARS Worksheet

This section contains instructions for completing the ARS worksheet (Form 3e) to decide how to best route calls.

For each trunk pool, you identify the trunk pool number, type of trunk (local, FX, regional WATS, and so on), whether the calls are toll or local calls, and the number of area codes or exchanges the pool should serve.

When placing a toll call using ARS, callers dial one of the following:

- **11 Digits.** 1 + 3 (area code) + 3 (exchange) + 4 (last 4 digits of the number)
- **8 Digits.** 1 + 3 (exchange) + 4 (last 4 digits of the number)
- **7 Digits.** 3 (exchange) + 4 (last 4 digits of the number)

Keep in mind that for 10-digit toll calls, callers must dial 1 before dialing the area code, even if they don't normally need to dial a prefix to make a toll call.

[Figure 4-1](#) provides a sample of a completed ARS worksheet.

Planning Form Instructions

1. Review Form 2c, System Numbering: Line/Trunk Jacks, for the types of lines/trunks available.
2. Record the number of exchanges in the local calling area in the blank at the top of Form 3e, Automatic Route Selection Worksheet. If you are not sure how many exchanges there are, consult the telephone directory.
3. Enter the number of each of the trunk pools (factory setting is 70 and 890–899) in the Trunk Pool No. column.



NOTES:

- Some trunk pools, such as in-state WATS trunk pools, can be used for both toll and local calls. (Note that with ARS, a local call is any call that does not require dialing a 1.)
 - If you expect people to use a particular trunk pool for both toll and local calls, enter the number of that trunk pool in the worksheet twice and note the reason.
4. For each trunk pool number entered:
 - a. In the Trunk Type column, record the type of trunk (local, FX, network, regional WATS, and so on) that is in the pool.
 - b. Under the Type of Dial heading, check the appropriate column (Local, Toll, or Network) for the type of call that should be dialed on each trunk pool:
 - **Toll.** Any call that has a series of digits beginning with a 1, followed by an exchange or area code.
 - **Local.** Any call that is not a toll call. This includes the seven-digit dialed numbers required in most areas.
 - **Network.** Any call that will be routed to a non-local switch.

- c. Enter the total number of different area codes or exchanges that the pool should serve in the Number of Area Codes or Exchanges for which Trunk Pool Is Used column.

⇒ NOTE:

If you do not know the exact number of exchanges or area codes, write a note such as *All area codes in the U.S. except the 15 served by the regional WATS lines/trunks*. Keep in mind that you are recording how many different area codes or exchanges the pool should access, not the area codes or exchanges themselves. This step helps identify the preferred trunk pools for toll and local calls. (Preferred pools are the trunk pools in which the system places each call unless a different route has been specified for that particular type of call.)

5. Under the Preferred Trunk Pools heading:
 - a. Determine which of the toll trunk pools is used for calls to the greatest number of different area codes. Write the number of that trunk pool in the space next to *For toll calls* (Table 17). Table 17 is explained later in this chapter.
 - b. Determine which of the local trunk pools is used for calls to the greatest number of different exchanges. Write the number of that trunk pool in the space next to *For local calls* (Table 18). Table 18 is explained later in this chapter.

[Figure 4-1](#) shows the completed Automatic Route Selection Worksheet for the fictitious company, McHale and Associates of Denver, Colorado (area code: 303). McHale has a local trunk pool, an in-state WATS pool, and a cross-country WATS pool. Because Colorado has three area codes (303, 719, and 970), the in-state WATS line/trunk can be used for both toll and local calls. [Figure 4-1](#) shows an example of two entries (for the 303 and 719 area codes) for Pool 890 on the worksheet.

The cross-country WATS trunk pool serves the greatest number of different area codes, every area code in the country except the two in Colorado. Therefore, it is the preferred trunk pool for toll calls.

The in-state WATS trunk pool serves the greatest number of different exchanges. It is the preferred trunk pool for calls to every exchange in area code 303, except the 20 exchanges in the local calling area. Therefore, it is the preferred trunk pool for local calls and some of these are toll calls.

If the local switch will use PSTN lines on a remote switch, see the *Network Reference* for the steps necessary to implement this.

Automatic Route Selection Worksheet*

Number of exchanges in the calling area _____

Trunk Pool No.	Trunk Type	Type of Dial			Number of Area Codes, Exchanges, or Network Destinations for which Trunk Pool is Used
		Toll	Local	Network	
70	Local		✓		20 Exchanges in local area
890 (for 303)	in-state WATS		✓		All exchanges in area code 303 minus 20 in local calling area
890 (for 719)	in-state WATS		✓		1 area code
891	Cross-Co. WATS	✓			All area codes in U.S. except 303 and 719

Preferred Trunk Pools
 For toll calls (Table 17) 891
 For local calls (Table 18) 70

Figure 4-1. Completed ARS Worksheet—Automatic Route Selection Tables

This section contains instructions for using the information you recorded on the worksheet to prepare the ARS tables. The system can have as many as 20 ARS tables—16 are programmed and 4 are factory set (Dial 0, Special Number, Default Local, and Default Toll tables).

Of the 16 programmable tables, each may contain one of the following types of information:

- **6-Digit Tables.** If the cost of calls to another area code varies according to the exchange, this table can be used to route calls on different trunk pools, depending on both the area code and the exchange. An area code is the first entry, and the remaining 99 entries are exchanges within the area code. The system scans the first six digits of the user-dialed number (area code and exchange) to route the call.

- **Area Code Tables.** These tables are lists of 3-digit area codes. Area code tables are useful if just one type of line/trunk is used for all calls to each area code on the list.
- **Local Exchange Tables.** These tables list 3-digit exchanges within the local area code. They can be used to route calls over in-state WATS.
- **1+7 Tables.** These tables contain a list of exchanges within the local area code that require dialing a 1 but not an area code before the 7 digits.

Because ARS routing requires care and planning, the instructions for filling out the planning forms are presented a few steps at a time with examples of completed forms shown after each group of steps. The instructions begin with the programmable tables (1 through 16) and introduce the factory-set tables midway through the process.

Planning Form Instructions

Complete Form 3f for each trunk pool listed on the ARS worksheet (Form 3e).



NOTE:

The digits before the blank lines in the Area Code/Exchanges section represent the table entry number used during programming.

On each copy of Form 3f:

1. Write the table number in the Table No. space (maximum 16). Start with the number 1 and proceed sequentially.
2. Check the appropriate box under the Type of Table heading: 6-Digit, Area Code, Exchange, or 1+7.
3. Do *either* of the following:
 - If this is *not* a 1+7 table, skip to Step 4.
 - If this is a 1+7 table, do *either* of the following:
 - If users do *not* need to dial a 1 to reach numbers within their own area code, check the Not Within Area Code box (factory setting).
 - If users need to dial a 1 to reach numbers within their own area code, check the Within Area Code box.

Complete the Area Code/Exchanges section by doing *either* of the following:

- If this is a 6-digit table, write the area code on the blank line next to entry 001. Then write each exchange to be called in that area code. Use the numbered lines, beginning with entry 002.

Up to 99 exchanges can be listed in any order. If you need to list another area code with exchanges, prepare another 6-digit table.

- If this is an Area Code, Exchange, or 1+7 table, write the area codes or exchanges on the numbered lines, beginning with entry 001.

Up to 100 area codes or exchanges can be listed in any order, but area codes and exchanges cannot be on the same table.

Example 1. If a business plans to use Table 1 to route calls to exchanges 333, 444, and 523 in area code 816, the upper section of the completed Form 3f will look similar to [Figure 4-2](#).

Example 2. If the business plans to use Table 7 to route calls to the northeastern (band 1) WATS lines/trunks as entries 001 through 015, the upper section of the completed form will look similar to the one shown in [Figure 4-3](#).

Automatic Route Selection Tables*

Maximum: 16 Tables. (Make a copy for each table.)

Table No. 1

Type of Table

- 6-Digit
- Area Code
- Exchange
- 1 + 7, dialing from
 - within area code
 - not within area code ◆

Area Code/Exchanges

001 <u>816</u>	021 _____	041 _____	061 _____	081 _____
002 <u>333</u>	022 _____	042 _____	062 _____	082 _____
003 <u>444</u>	023 _____	043 _____	063 _____	083 _____
004 <u>523</u>	024 _____	044 _____	064 _____	084 _____
005 _____	025 _____	045 _____	065 _____	085 _____
006 _____	026 _____	046 _____	066 _____	086 _____
007 _____	027 _____	047 _____	067 _____	087 _____
008 _____	028 _____	048 _____	068 _____	088 _____
009 _____	029 _____	049 _____	069 _____	089 _____
010 _____	030 _____	050 _____	070 _____	090 _____
011 _____	031 _____	051 _____	071 _____	091 _____
012 _____	032 _____	052 _____	072 _____	092 _____
013 _____	033 _____	053 _____	073 _____	093 _____
014 _____	034 _____	054 _____	074 _____	
015 _____	035 _____	055 _____		
016 _____	036 _____			
017 _____	037 _____			
018 _____				
019 _____				

Figure 4-2. Example 1: Form 3f, 6-Digit Table

Form 3f
Automatic Route Selection Tables*

Maximum: 16 Tables. (Make a copy for each table.)

Table No. 7

Type of Table

- 6-Digit
- Area Code
- Exchange
- 1 + 7, dialing from
 - within area code
 - not within area code ◆

Area Code/Exchanges

001 <u>413</u>	021 _____	041 _____	061 _____	081 _____
002 <u>617</u>	022 _____	042 _____	062 _____	082 _____
003 <u>203</u>	023 _____	043 _____	063 _____	083 _____
004 <u>508</u>	024 _____	044 _____	064 _____	084 _____
005 <u>401</u>	025 _____	045 _____	065 _____	085 _____
006 <u>516</u>	026 _____	046 _____	066 _____	086 _____
007 <u>518</u>	027 _____	047 _____	067 _____	087 _____
008 <u>914</u>	028 _____	048 _____	068 _____	088 _____
009 <u>717</u>	029 _____	049 _____	069 _____	089 _____
010 <u>201</u>	030 _____	050 _____	070 _____	090 _____
011 <u>603</u>	031 _____	051 _____	071 _____	091 _____
012 <u>207</u>	032 _____	052 _____	072 _____	092 _____
013 <u>215</u>	033 _____	053 _____	073 _____	093 _____
014 <u>802</u>	034 _____	054 _____	074 _____	
015 <u>609</u>	035 _____	055 _____		
016 _____	036 _____			
017 _____	037 _____			
018 _____				
019 _____				

Figure 4-3. Example 2: Form 3f, Area Code Table

Subpatterns

For each table (1 through 16, and factory-set Tables 17 and 18), you can select two subpatterns (A and B) that specify routes to be used at different times. You can specify up to six routes for each subpattern. For example, you may want calls to certain area codes routed over WATS lines/trunks during the day; after 11 p.m., when toll rates are less expensive on basic lines/trunks, you may want the calls routed over the main pool.

For each of the 12 routes (six for each subpattern), you can specify a Facility Restriction Level (FRL). The FRL is used to refine the route selection process still further. Each route is assigned an FRL from 0 through 6 (6 is the most restricted). Each telephone is also assigned an FRL from 0 through 6 (0 is the most restricted). Callers (extension or remote access barrier code/trunk) can use the route only if their FRL is equal to or greater than that specified for the route. You assign a value of 0 to the route if you want all users to access the route, or 1 through 6 to restrict calling for the route to specific users only.

The form for a typical Area Code Table, illustrated in [Figure 4-4](#), shows a table to route calls to the 13 area codes served by the northeastern (band 1) WATS lines beginning at 8 a.m. with no restrictions. The number of the northeastern WATS pool, 891, is on the first line in the Subpattern A section. The time, 8:00 a.m., is in the Time of Day space, and an FRL of 0 indicates no restrictions. The 11 p.m. in the Time of Day space for Subpattern B and Pool 70 in the Pool column indicates that calls to these area codes are to be routed over the main pool after 11 p.m.

Planning Form Instructions

In the Subpattern sections on Form 3f and Form 3g:

1. To direct calls differently according to time of day, write a starting time for each subpattern in the Time of Day space (for example, 8 a.m.).
2. To complete the Pool column for each subpattern, write the number of the preferred trunk pool next to the number 1. This is the pool to which calls to the area codes or exchanges listed in the Area Code/Exchanges section of this form should be directed.

If you want to designate a backup pool in case all the lines/trunks in the first choice pool are busy, write the number of the backup trunk pool next to the number 2, and so on.

3. To complete the FRL column, enter a value of 0 through 6. Assign a value of 0 if you want all users to access the route, or 1 through 6 to restrict calling for the route to specific users only. For all except the Default Local Table, the factory setting is 3. The Default Local Table factory setting is 2.
4. If extra digits at the beginning of the dialed number may be required for the system to place a call on a particular pool, enter the digits (0 through 9) in the same row as the pool number, in the column under the Other Digits heading. (See the Other Digits example below, in [Figure 4-5](#).)

These special access or account codes can range from a single digit, such as 9, to a maximum of 20 digits.

Because calls to the 15 area codes shown on [Figure 4-4](#) should be placed on the cross-country WATS lines/trunks when all the northeastern WATS lines/trunks are busy, the number of the cross-country WATS pool, 890, is used in both cases. An FRL of 4 is assigned to restrict some users from using cross-country WATS lines/trunks.

Example: If a business uses a different long-distance company for calls to nine area codes in Canada, accessing the alternate long-distance company lines requires getting a local line and dialing seven digits. The completed form for the Area Code Table that routes these calls to the alternate long-distance company lines is shown in [Figure 4-5](#).

Form 3f
Automatic Route Selection Tables*

Maximum: 16 Tables. (Make a copy for each table.)

Table No. 2

Type of Table

- 6-Digit
- Area Code
- Exchange
- 1 + 7, dialing from
 - within area code
 - not within area code ◆

Area Code/Exchanges

001 <u>413</u>	021 _____	041 _____	061 _____	081 _____
002 <u>617</u>	022 _____	042 _____	062 _____	082 _____
003 <u>203</u>	023 _____	043 _____	063 _____	083 _____
004 <u>508</u>	024 _____	044 _____	064 _____	084 _____
005 <u>401</u>	025 _____	045 _____	065 _____	085 _____
006 <u>516</u>	026 _____	046 _____	066 _____	095 _____
007 <u>518</u>	027 _____	047 _____	076 _____	096 _____
008 <u>914</u>	028 _____	057 _____	077 _____	097 _____
009 <u>717</u>	029 _____	058 _____	078 _____	098 _____
010 <u>201</u>	039 _____	059 _____	079 _____	099 _____
011 <u>603</u>	040 _____	060 _____	080 _____	100 _____

Subpattern A Time of Day <u>8:00 am</u>					Subpattern B Time of Day <u>11:00 pm</u>				
Pool	FRL (3 ◆) [†]	Other Digits	Absorb	Call Type [†] (Both ◆)	Pool	FRL (3 ◆) [†]	Other Digits	Absorb	Call Type [†] (Both ◆)
1 <u>891</u>	<u>0</u>	_____	1 _____	<u>V</u>	1 <u>70</u>	<u>0</u>	_____	1 _____	<u>V</u>
2 <u>890</u>	<u>4</u>	_____	2 _____	<u>V</u>	2 <u>890</u>	<u>4</u>	_____	2 _____	<u>V</u>

Figure 4-4. Subpattern Example

Form 3f
Automatic Route Selection Tables*

Maximum: 16 Tables. (Make a copy for each table.)

Table No. 3

Type of Table

- 6-Digit
- Area Code
- Exchange
- 1 + 7, dialing from
 - within area code
 - not within area code ◆

Area Code/Exchanges

001 <u>604</u>	021 _____	041 _____	061 _____	081 _____
002 <u>403</u>	022 _____	042 _____	062 _____	082 _____
003 <u>306</u>	023 _____	043 _____	063 _____	083 _____
004 <u>204</u>	024 _____	044 _____	064 _____	084 _____
005 <u>807</u>	025 _____	045 _____	065 _____	_____
006 <u>705</u>	026 _____	046 _____	_____	095 _____
007 <u>519</u>	027 _____	_____	076 _____	096 _____
008 <u>416</u>	028 _____	057 _____	077 _____	097 _____
009 <u>613</u>	_____	058 _____	078 _____	098 _____
010 _____	039 _____	059 _____	079 _____	099 _____
_____	040 _____	060 _____	080 _____	100 _____

Subpattern A Time of Day _____					Subpattern B Time of Day _____				
Pool	FRL (3 ◆)‡	Other Digits	Absorb	Call Type† (Both ◆)	Pool	FRL (3 ◆)‡	Other Digits	Absorb	Call Type† (Both ◆)
1 <u>70</u>	_____	<u>905012</u>	1 _____	<u>V</u>	1 _____	_____	_____	1 _____	_____

Figure 4-5. Other Digits Example

5. If the system must absorb certain leading digits dialed by users to place calls on a particular pool, enter a number in the same row as the pool number, in the Absorb column.

Use the number 0 if you do not want absorption. Assign a value of 1 through 11 according to the number of digits you want absorbed, starting with the first digit dialed.

Example: If a company has FX lines/trunks for the 686 exchange in the 901 area code and wants to allow people to dial those calls the same way they dial toll calls to other area codes, an absorption number of 4 is assigned to the FX trunk pool, Pool 893. The completed form for the 6-Digit Table that routes calls to the FX trunk pool is shown in [Figure 4-6](#).

After ARS is programmed, people in the company, illustrated in [Figure 4-6](#), dial 1-901-686-XXXX to make these calls. The system absorbs the leading 1 and the area code and dials only the seven-digit number to place these calls on one of the FX lines/trunks.

Form 3f
Automatic Route Selection Tables*

Maximum: 16 Tables. (Make a copy for each table.)

Table No. 4

Type of Table

- 6-Digit
- Area Code
- Exchange
- 1 + 7, dialing from
 - within area code
 - not within area code ♦

Area Code/Exchanges

001 <u> 901 </u>	021 _____	041 _____	061 _____	081 _____
002 <u> 686 </u>	022 _____	042 _____	062 _____	082 _____
003 _____	023 _____	043 _____	063 _____	083 _____
004 _____	024 _____	044 _____	064 _____	084 _____
005 _____	025 _____	045 _____	065 _____	_____
006 _____	026 _____	046 _____	_____	_____
007 _____	027 _____	_____	_____	095 _____
008 _____	028 _____	_____	076 _____	096 _____
009 _____	_____	057 _____	077 _____	097 _____
010 _____	_____	058 _____	078 _____	098 _____
_____	039 _____	059 _____	079 _____	099 _____
_____	040 _____	060 _____	080 _____	100 _____

Subpattern A Time of Day _____					Subpattern B Time of Day _____				
Pool	FRL (3 ♦)†	Other Digits	Absorb	Call Type† (Both ♦)	Pool	FRL (3 ♦)†	Other Digits	Absorb	Call Type† (Both ♦)
1	893	_____	1	4	V	1	_____	1	_____
2	_____	_____	2	_____	2	_____	_____	2	_____
3	_____	_____	3	_____	3	_____	_____	3	_____
4	_____	_____	4	_____	4	_____	_____	4	_____
5	_____	_____	5	_____	5	_____	_____	5	_____
6	_____	_____	6	_____	6	_____	_____	6	_____

♦ Factory Setting
 * Hybrid/PBX mode only
 † Select Voice only, Data only, or Both.
 ‡ Local Tables Default FRL is 2.

Figure 4-6. Digit Absorption Example

6. To complete the Call Type column, enter *one* of the following:
 - For voice only calls, write V.
 - For data only calls, write D.
 - For both voice and data calls, write Both.



NOTE:

Pools should be labeled as Voice unless they can support digital data. Both can be used for BRI, PRI, and private network PRI pools. Data can be used for T1 Switched 56 pools, and to reserve lines for data in BRI, PRI, and private network PRI pools.

7. If you have worked on only one of your planned non-default tables, complete all copies of Form 3f. Repeat Steps 1 through 6 for each table (Tables 1 through 16) that you need.
8. If you have not completed the factory-set tables, do so now:
 - a. For Tables 17 (Default Toll) and 18 (Default Local), repeat Steps 1 through 6 to complete the subpattern and pool routing sections.
 - b. For the Dial 0 table (Table 19), complete the Pool routing, Facility Restriction Level (FRL), and Other Digits entries following Steps 2 through 4. If the switch is part of a private network, and the private network needs to use the Dial 0 table, see the *Network Reference* for information.



WARNING:

In the next step, assigning a restrictive FRL could impair the ability to dial 911.

- c. If users need to dial an access code to call the special numbers 411, 611, 811, and 911, record that code on the Special Number Table (20), under the Other Digits heading. Assign the FRL as shown in Step 3. If the switch is part of a private network and the private network needs to use the Special Numbers table, see the *Network Reference* for information.
9. If restricting extensions, private network calls, and remote access users from specific routes, locate Form 6g, Call Restriction Assignments and Lists:
 - a. Under the ARS Restriction Level heading on each telephone form, write the value (0 to 6) you want to assign.
 - b. Under the ARS Restriction Level heading on pages 3 and 4 of Form 3a, check the value (0 to 6) you want to assign.

Extension and Remote Access FRL values must be equal to or greater than the FRL value assigned to routes in order for users to access those routes. A value of 0 is the most restrictive, and a value of 6 is the least restrictive. The factory-set FRL value assigned to extensions is 3.

To restrict an extension from specific routes, assign an FRL value to the extension that is lower than the route's value.

For example, if you want to limit a user from making calls on pools with special-use lines/trunks such as WATS, assign a value of 0. If you want a telephone used by a top executive to have unlimited use of any ARS route, assign a value of 6.

Data Communications

5

Overview

In addition to voice communications capabilities, the system also supports data and video communications to enable users to send or receive data, or establish group or personal video conferences.



NOTE:

To configure the switch to support data communications across a private network, see the *Network Reference* for information.

Planning for data and video communications consists of the following tasks:

1. Planning how the data and/or video equipment connects to extension jacks on the control unit. This depends on the type of data stations or video systems.
2. Creating modem/ISDN terminal adapter pools (pairs of modems and ISDN terminal adapters) to enable calls between the two types of data stations: modem data stations and ISDN terminal adapter data stations.
3. Assigning lines/trunks to data stations and video systems.
4. Assigning features to data stations.
5. Creating data hunt groups (DHGs), that is, data calling groups, if there are modem/ISDN terminal adapter pools with more than one data communications equipment pair (a modem and an ISDN terminal adapter), or to designate a group of either modems or ISDN terminal adapters to receive calls to communicate with a local host computer or local area network (LAN) workstation.



NOTE:

Modem/ISDN terminal adapter pools are not described in this book. For information, see the application note, *MERLIN LEGEND Communications System Modem Pooling*.

6. Configuring MLX jacks for 2B Data (2 B-channel) connectivity. This allows video systems to use both B-channels on a single MLX jack to establish high-speed video connections at data rates of up to 128-kbps.



NOTES:

- For additional information on 2B Data/Video and for information on connecting video systems to the MERLIN LEGEND System, refer to the *Data and Video Reference*.
- For information on ordering desktop video equipment, refer to Marketing Announcement Letter *GBCS-96-05-001, Multi-Vendor Desktop Videoconferencing Offer*.

Following an explanation of the terminology used in this chapter and an overview of data communications, this chapter contains instructions for planning data and video communications. Some procedures involve making additional entries on the forms already completed earlier in this guide; others involve filling out data forms as described in "[Assigning Extension Jacks](#)," later in this chapter.

Instructions for using the data and video communications capabilities are contained in the *Data and Video Reference*.

Terminology

The following terms are used in this chapter:

- **Data Station.** A hardware configuration used to send and receive data (and sometimes voice signals, depending on the equipment). The configuration includes data terminal equipment (DTE) for input and output of data, and data communications equipment (DCE) to enable the transmission of data over digital or analog telephone lines and trunks. There are two types of data stations:
 - **Modem Data Station.** Connects to the control unit through an analog extension jack or a T/R jack and requires a modem. Analog data stations can support analog data and analog voice, analog data only, or analog data and MLX voice.
 - **ISDN Terminal Adapter Data Station.** Connects to the control unit through an MLX extension jack and requires an ISDN terminal adapter. ISDN terminal adapter data stations can support ISDN terminal adapter data and MLX voice or ISDN terminal adapter data only.

- **Data Terminal Equipment (DTE).** Data station equipment—for example, a PC, host computer, or LAN workstation, from which data is input and/or output. DTE, which can also be referred to as a data terminal, uses data communications equipment (DCE) to transmit and receive the digital signals it requires.
- **Data Communications Equipment (DCE).** Data station equipment that enables the transmission of data over digital or analog telephone lines and trunks. DTE requires DCE as follows:
 - **Modem.** A type of data communications equipment that converts the DTE's outgoing digital signals into analog signals for transmission over regular (analog) telephone company lines. Another modem at the receiving data station converts the analog signals back into digital signals for reception by the DTE—for example, a PC. An analog data station uses a modem as its DCE.
 - **ISDN Terminal Adapter.** A type of data communications equipment that transmits digital signals over digital telephone company facilities—for example, PRI. A digital data station uses an ISDN terminal adapter as its DCE.
- **Data Terminal.** Data station equipment (for example, a PC, host computer, LAN workstation, Group IV fax machine, or a group videoconferencing installation) from which data is input and/or output. A data terminal uses data communications equipment (DCE) to transmit and receive the digital signals it requires.
- **Modem/ISDN Terminal Adapter Pool.** A special type of hardware configuration that combines one or more pairs of DCEs to enable communication between modems and ISDN terminal adapter data stations. A pair consists of one modem and one ISDN terminal adapter. Modem/ISDN terminal adapter pools are set up in one of two ways depending on the type of data station being used to *send* data: analog-to-digital or digital-to-analog. For more information about these pools, see the application note, *MERLIN LEGEND Communications System Modem Pooling*.
- **Data Hunt Group (DHG).** A data calling group typically used to distribute calls to modem/ISDN terminal adapter pools that have more than one pair of DCEs. For more information about DHGs, see the application note, *MERLIN LEGEND Communications System Modem Pooling*.
- **Video System.** Equipment that allows desktop or group videoconferencing. This equipment connects either directly or through an ISDN terminal adapter to an MLX jack on the MERLIN LEGEND System. If the MLX port is programmed as a 2B Data port, the video systems can use both of the B-channels assigned to the MLX port to provide video. Many video applications also support data sharing and/or transfer.



NOTE:

If the video system is connected to the MLX jack through an ISDN terminal adapter, unless the ISDN terminal adapter itself supports 2B Data communications, it is recommended that the MLX port *not* be programmed as a 2B Data port.

About Data and Video Communications

This section provides a high-level overview of the system's data and video communications capabilities, followed by more detailed information about some of the equipment and concepts introduced in this overview.

Connectivity

Data communications connectivity enables the system to share resources, as well as to establish and manage connections between computers and other data devices.

Video communications connectivity enables users to conduct personal or group video conferences and to share data and applications (also known as Video Collaboration).

The system control unit (hardware and software) in conjunction with other external hardware devices provides data and video connectivity for the following:

- On-premises analog data stations.
- Connection to off-premises data stations by way of an analog line/trunk (GS, LS, Tie, or DID), by way of a dedicated analog line/trunk, or by way of a DS1 Digital Service Link providing emulated GS, LS, Tie or DID trunks.
- On-premises ISDN terminal adapter data stations.
- Connection to off-premises digital data stations by way of a PRI, NI-1 BRI, or T1 Switched 56 facility (including T1-Tie trunks using T1 Switched 56 service).
- Connections between two similar types of data stations.
- Connection between a digital data station (on a B-channel) and an analog data station by way of 2-stage dialing through a modem/ISDN terminal adapter pool. This configuration is not described in this book; see the application note, *MERLIN LEGEND Communications System Modem Pooling*.
- On-premises host computer access.
- Local area network (LAN) access by way of a modem or ISDN terminal adapter connected to an RS-232 port on a workstation on the LAN.
- On- and Off-premises personal or group video systems by way of a digital PRI, NI-1 BRI, or T1 Switched 56 facility (including T1-Tie trunks using T1 Switched 56 service).

Data Stations

A data station is a hardware configuration used to send and receive data (and/or voice, depending on the equipment). The configuration must include two main components: data terminal equipment (DTE) for input or output of data, along with data communication equipment (DCE) to enable the transmission of data over analog or digital lines/trunks. Depending on the station configuration, it may or may not include a telephone, either analog or an MLX telephone.

The DTE is usually a PC, but can be a host computer, a LAN workstation, a printer, an optical scanner, or a video system or other equipment used for data input and/or output.

The DCE, which is either a modem or an ISDN terminal adapter, allows data from the DTE to be transmitted over digital or analog telephone lines/trunks. The DCE, which has capabilities similar to a telephone, also can make the data call, maintain the connection, and terminate the data call.



NOTE:

The DCE and DTE may have hardware and/or software options that can be set for transferring and receiving data, such as parity and bit rate. For more information, refer to the DTE and DCE documentation for configuration compatibility requirements, options, and guidelines for changing options.

There are two types of data stations:

- **Modem Data Station.** This type of data station sends and receives analog data. It includes a modem as its DCE and is connected to an analog extension jack or T/R jack on the control unit.
- **ISDN Terminal Adapter Data Station.** This type of data station sends and receives digital data. It includes an ISDN terminal adapter as its DCE and is connected to a digital extension jack (MLX port) on the control unit.

Within each type, there are several configurations, depending on the station's capabilities (for example, voice and data or data only) and, therefore, what equipment is involved and what type of module it connects to on the control unit.

This section describes each type of data station and the configurations supported within each type.

Modem Data Stations

A modem data station uses a modem as its DCE to send and receive data.

The modem converts digital signals from the DTE at the originating station into analog signals so the data can be transmitted over analog telephone lines/trunks. At the receiving station, the modem converts the analog signals back to digital signals so the DTE at that end can accept them. A modem may provide dialing and answering capabilities for a modem data station; if not, a telephone can be connected to dial out.



NOTE:

If an analog multiline telephone is connected to the modem data station, the telephone and data station can be used at the same time. A voice call can be made or received while a data call is in progress. A data call cannot be made or received while a voice call is in progress.

A modem data station can be used to make analog data calls either over the telephone company network or to a data station inside the system.

The interface for a modem data station is the tip/ring (T/R) interface provided by one of the following:

- A General-Purpose Adapter (GPA), connected to an analog multiline telephone
- A port on a T/R module (012 (T/R), 016 (T/R), or 008 OPT)
- A port programmed for T/R operation on an 016 ETR or 412 LS-ID-ETR module (Release 7.0 and later)
- A Multi-Function Module (MFM) adjunct on an MLX telephone

There are different types of modem data stations, depending on the data station capabilities:

- Modem voice and analog data (analog voice-and-data)
- Modem data only
- Modem data and MLX voice

Each of these use different equipment as described in this section.

Analog Voice and Modem Data

This type of modem data station includes an analog multiline telephone, a modem, and a DTE (a data terminal or PC) (see [Figure 5-1](#)). The modem connects to the control unit through the T/R interface of a General-Purpose Adapter (GPA). The telephone connects to the system through an analog port on the control unit.

The port configuration requires two adjacent odd/even extension jacks on a 408 (LS-ATL), 408 GS/LS, or 008 module in the control unit. The even jack is for voice and the odd jack is for data. The bridging adapter joins the odd/even jack pair for connection to the analog multiline telephone. The telephone provides the dialing capability for the data station.

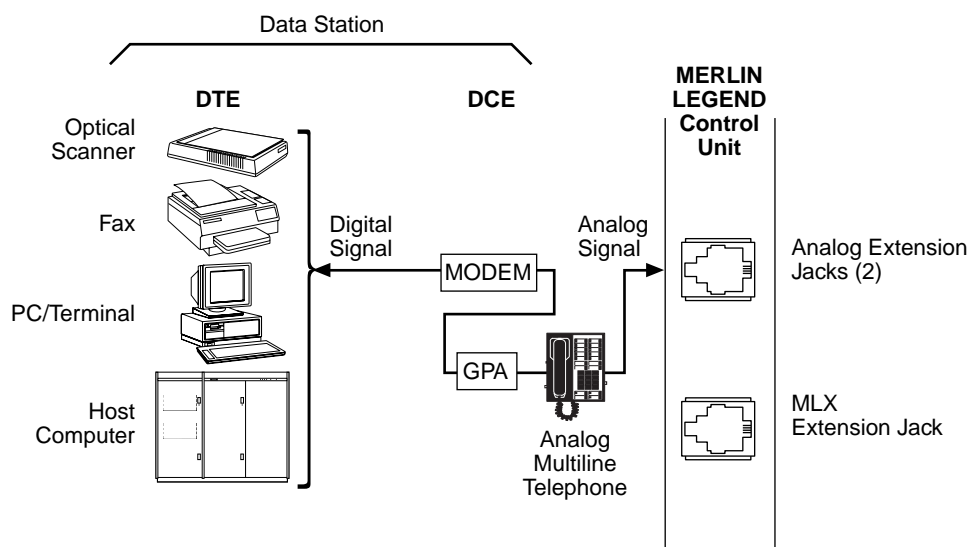

Figure 5-1. Analog Voice and Modem Data

Modem Data-Only

This type of modem data station includes only DTE and a modem (see [Figure 5-2](#)). The modem connects to the control unit through an analog port on a T/R module. If the modem does not provide dialing capability, a single-line telephone can be connected to it to provide dial-out capability; however, the data station and the telephone cannot be used simultaneously.

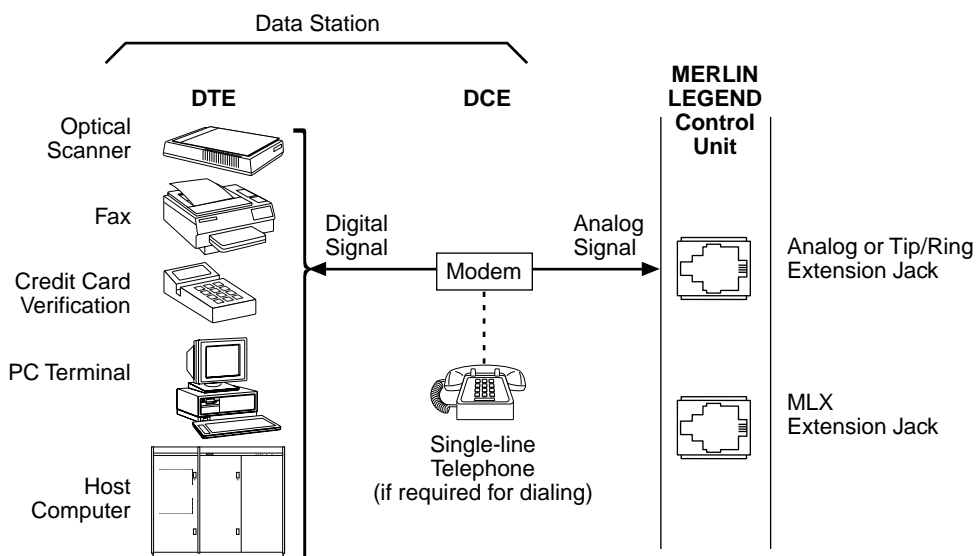

Figure 5-2. Modem Data-Only

MLX Voice and Modem Data

This type of analog data station includes an MLX telephone in addition to the DTE and modem (see [Figure 5-3](#)). The modem connects to the MLX telephone through the T/R interface of the Multi-Function Module (MFM), which is installed in the MLX telephone. The telephone connects to the control unit through an MLX extension jack. The communication capabilities of the MLX telephone and data station can be used simultaneously.

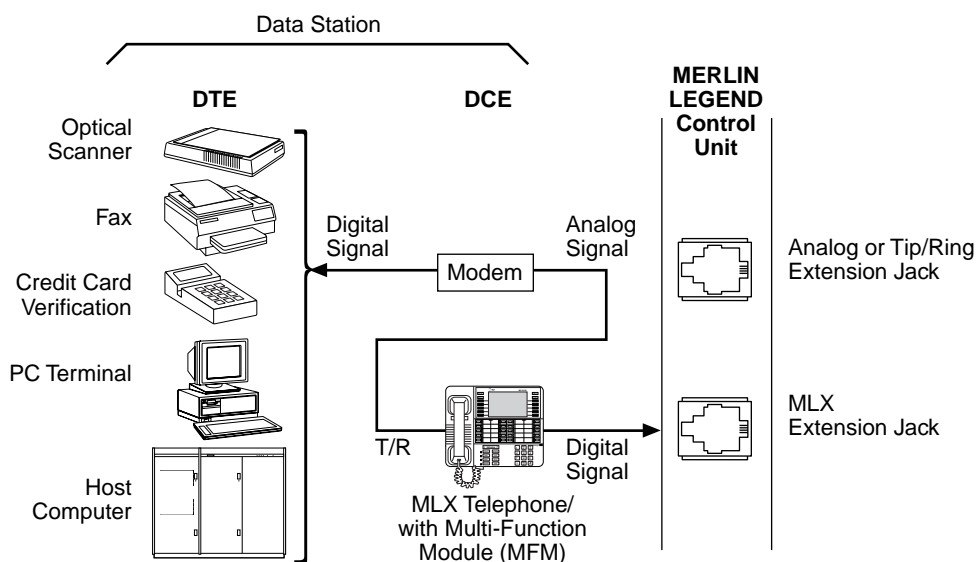

Figure 5-3. MLX Voice and Modem Data

ISDN Terminal Adapter Data Stations

An ISDN terminal adapter data station uses an ISDN terminal adapter as its DCE to send and receive data and connects to a digital extension jack (MLX port) on the control unit. If PRI, NI-1 BRI, or T1 Switched 56 facilities (including T1-Tie trunks using T1 Switched 56 service) are assigned to the MLX port, that port may be configured as a 1B Data or 2B Data port. In a 1B configuration, only one of the assigned B-channels is used by the ISDN terminal adapter data station. The 2B configuration allows the simultaneous use of both B-channels.

The ISDN terminal adapter adapts the DTE to the MLX environment. Instead of converting digital signals to analog signals as a modem does, the ISDN terminal adapter maintains a digital data format that allows transmission to another inside ISDN terminal adapter station or over the PRI, NI-1 BRI, or T1 Switched 56 telephone network.

The ISDN terminal adapter can provide dialing and answering capabilities to the data station, and can share the MLX extension jack with an MLX telephone.

An ISDN terminal adapter data station can be used to make data calls either over digital telephone facilities (PRI, NI-1 BRI, or T1 Switched 56 facilities) or to an ISDN terminal adapter data station inside the system.

There are different types of ISDN terminal adapter data stations depending on the data station's capabilities:

- MLX voice and ISDN terminal adapter data (digital voice-and-data)
- ISDN terminal adapter (data-only)

MLX Voice and ISDN Terminal Adapter Data

This type of ISDN terminal adapter data station includes an MLX telephone in addition to the DTE and ISDN terminal adapter (see [Figure 5-4](#)). The ISDN terminal adapter connects to the control unit through an MLX port. The MLX port is shared by both the telephone and the data station, but they operate independently of each other and can be used simultaneously.

⇒ NOTE:
 In an MLX voice and ISDN terminal adapter data station, the MLX telephone cannot contain an MFM.

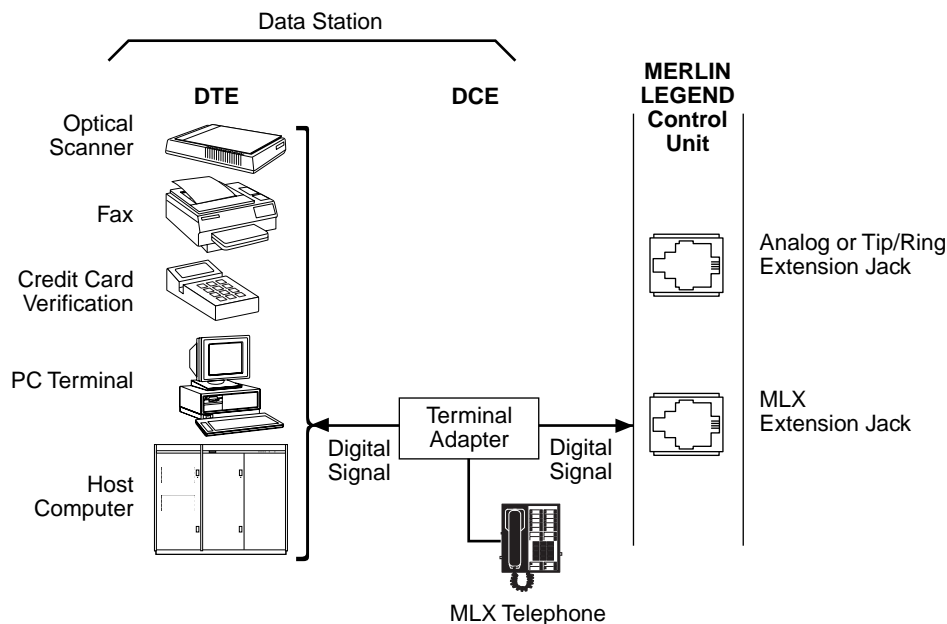

Figure 5-4. MLX Voice and ISDN Terminal Adapter Data

ISDN Terminal Adapter Data-Only

This type of digital data station includes only the DTE and ISDN terminal adapter. The ISDN terminal adapter connects the DTE to the system through an MLX extension jack on the control unit (see [Figure 5-5](#)). Since the configuration does not include an MLX telephone, if a 7500B data module is used as the ISDN terminal adapter, a 440A4 terminating resistor adapter is required.

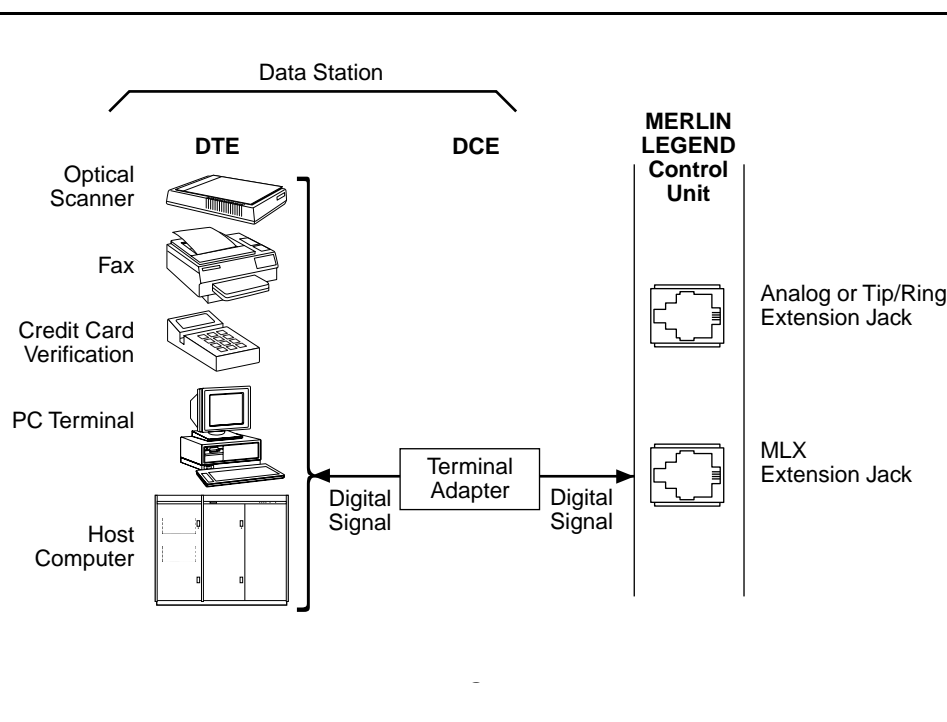

Figure 5-5. ISDN Terminal Adapter Data-Only

Summary of Data Station Configurations

[Table 5-1](#) describes the extension jacks and equipment required for each data station configuration.

5 Data Communications

About Data and Video Communications

5-12

Table 5-1. Data Station Configurations

Type of Data Station	Module and Jack Type	Telephone (for voice)	GPA or MFM	Modem or ISDN Terminal Adapter	Data Terminal
Analog voice and modem data	2 adjacent extension jacks on one of the following analog modules: 408 (LS-ATL), 408 GS/LS, or 008	Analog multiline telephone (and a BR-241-B1 bridging adapter)	GPA	Modem	PC
Modem data-only	1 extension jack on an 012 (T/R), 016 (T/R), 016 ETR, 008 OPT, or 412 LS-ID-ETR module	None	None	Modem	PC, LAN workstation, or local host
MLX voice and Modem data	1 extension jack on an 008 MLX, 016 MLX, 408 GS/LS-MLX, or 408 GS/LS-ID-MLX module	MLX telephone	MFM	Modem	PC or LAN workstation
MLX voice and ISDN terminal adapter data	1 extension jack on an 008 MLX, 016 MLX, 408 GS/LS-MLX, or 408 GS/LS-ID-MLX module	MLX telephone	None	ISDN terminal adapter	PC, LAN workstation, local host, or video-conferencing
ISDN terminal adapter data-only	1 extension jack on an 008 MLX, 016 MLX, 408 GS/LS-MLX, or 408 GS/LS-ID-MLX module	None	None	ISDN terminal adapter (if using a 7500B data module, a 440A4 terminating resistor adapter is also required)	PC, LAN workstation, local host, or video-conferencing
Digital Data/Video	1 extension jack on an 008 MLX, 016 MLX, 408 GS/LS-MLX, or 408 GS/LS-ID-MLX module set as a 2B Data port, or 2 jacks set as 1B Data ports ¹	None	None	None if station is connected by a BRI interface. One ISDN terminal adapter if the TA supports 2B Data. Two ISDN terminal adapters if the TAs support only 1B Data	G4 FAX or video-conferencing

¹ A digital data/video station that connects directly to an MLX port, using either a BRI interface or a v.35 interface and an ISDN terminal adapter that supports 2B Data, requires only one MLX port programmed as a 2B Data port. A digital data/video station that connects to an MLX port, using a v.35 interface and an ISDN terminal adapter that does not support 2B Data, requires two 1B Data MLX ports.

Other Supported Data Terminals

Other data equipment that can be connected to the system includes analog data terminals using modem connections, such as the following:

- A local host computer
- Group III (G3) fax machine
- An output-only device
- An input-only device

A PC containing an internal modem card can also be connected to a T/R interface.

Other digital data terminals may be connected using ISDN terminal adapters, including the following:

- Group videoconferencing system
- Group IV (G4) fax machine

Other Resource Groups

You can create the following types of special groups:

- **Modem-Only Group.** Provides access to multiport data equipment, for example, a caller at a data station calling an online database system at an outside number, over analog lines/trunks.
- **ISDN Terminal Adapter-Only Group.** Provides access to multiport equipment—for example, a host computer—by assigning the MLX ports interfacing with the ISDN terminal adapters in the pool to a DHG.

Data Hunt Groups

A data hunt group (DHG) is similar to a voice-extension calling group, except that the group in this case is a group of modems or a group of ISDN terminal adapters (not both). The group can be used to communicate with a local host computer or workstation (gateway) on a LAN.

All modems or ISDN terminal adapters in a DHG are assigned to a single extension number that is used both by inside and outside callers to reach the group. Users are given the DHG number that corresponds to the pool they need to reach.

Calls to the group are distributed among group members in a circular pattern. The system hunts for the first available modem or ISDN terminal adapter, starting with the one that received the last call. If all group members are unavailable, the caller hears a ringback tone.

Guidelines for creating DHGs are contained in "[Creating Data Hunt Groups](#)," later in this chapter.

Data Hunt Group Configurations

The following DHG configurations work on the system:

- **ISDN Terminal Adapters.** Allows communications with the local host computer or a workstation (gateway) to a LAN.
- **Modems.** Allows communications with the local host computer or a workstation (gateway) to a LAN.

Video Systems

A video system is a hardware configuration that provides video teleconferencing. The video systems use both B-channels (2B Data) associated with an MLX port to achieve data rates of up to 128-kbps when using PRI or NI-1 BRI facilities, and 112-kbps when using T1 Switched 56 facilities.

There are two basic types of video teleconferencing:

- **Personal Videoconferencing.** This type, also referred to as Desktop Videoconferencing, typically is a single user communicating with another individual using their PC.
- **Group Videoconferencing.** This type, as the name implies, allows larger groups of people to communicate with another group at a different location.

Personal Videoconferencing

A personal videoconferencing system typically consists of a video camera and an audio unit connected to a PC. The PC, when equipped with a BRI interface card, can connect directly to any available MLX port on a 408 GS/LS MLX, 408 GS/LS-ID-MLX, 008 MLX, or 016 MLX module.

The MLX port must be configured as a 2B Data port in order to provide the necessary high-speed data connection needed to support video applications. The network facilities used by the endpoint connected to the MLX port may be PRI, T1 Switched 56 (both provided by the 100D module), or NI-1 BRI (provided by the 800 NI-BRI module) facilities.



NOTE:

Some applications also provide data and application sharing and transfer capabilities (video collaboration) in addition to videoconferencing.

This configuration, in which the personal video system is the only device connected to the MLX port, is called the Stand-alone configuration. Some personal video systems also offer the capability to support a Passive Bus configuration. See [Figure 5-6](#) in the next section for a sample connection diagram.

Group Videoconferencing

A group videoconferencing system consists of a video camera, an audio unit, and a display screen (such as a television) that connect to a coder-decoder (CODEC). The CODEC converts the analog voice and video signals into digital form for transmission, and converts the digital signals received back into analog form.

The CODEC may use either a BRI interface to connect directly to an available MLX port on a 408 GS/LS MLX, 408 GS/LS-ID-MLX, 008 MLX module, 016 MLX (Release 7.0 and later systems) module, or a v.35 interface to connect to an ISDN terminal adapter, which in turn connects to an MLX port.

When the group videoconferencing system uses a BRI interface, or an ISDN terminal adapter that supports 2B Data, the video system may be connected to a single MLX port that has been configured as a 2B Data port. This allows the video system to use both B-Channels assigned to the MLX port, thereby achieving the high-speed data connection necessary to support video.

If the group videoconferencing system uses a v.35 interface to connect to an ISDN terminal adapter that does not support 2B Data, then two ISDN terminal adapters are required (each connecting to a separate MLX port that has been configured as a 1B Data port) in order to achieve a 2B Data connection.



NOTE:

Do not connect equipment that does not support 2B Data—such as an ISDN terminal adapter or G4 fax machine—to an MLX port that has been configured as a 2B Data port. This wastes system resources and may cause other system errors.

The network facilities used by the endpoint connected to the MLX port may be any combination of PRI, T1 Switched 56 (both provided by the 100D module), and/or NI-1 BRI (provided by the 800 NI-BRI module) facilities; however it is recommended that you use two B-channels of the same type to ensure the best possible connection. See [Figure 5-6](#) for a sample connection diagram.



NOTE:

See the *Network Reference* for information on group videoconferencing over private network tandem trunks.

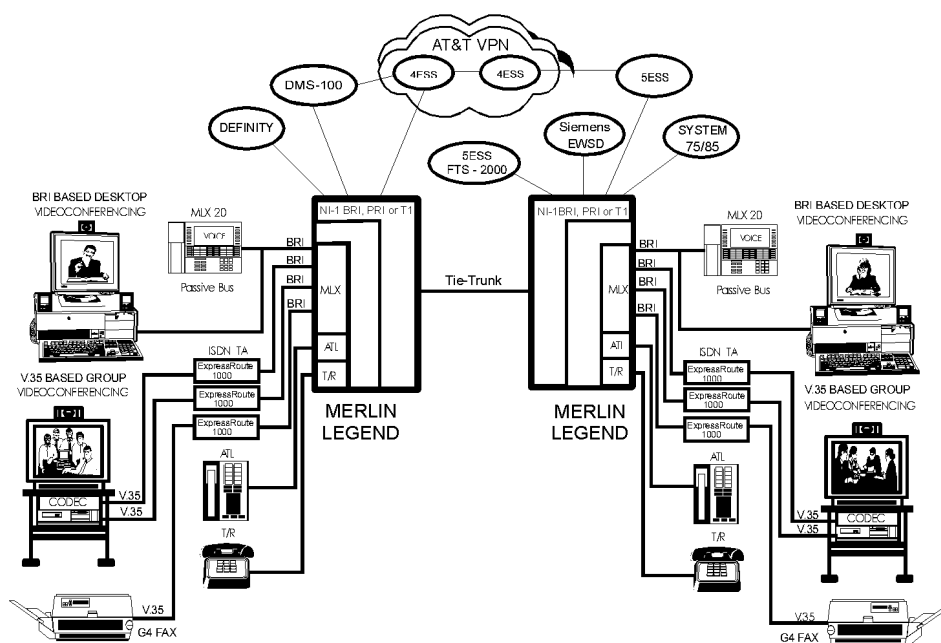

Figure 5-6. Personal and Group Video Connections

Planning Overview

By using the procedures earlier in this guide, you should have already reserved the following:

- Trunk jacks for outside lines/trunks
- Extension jacks for voice telephone users
- Extension jacks for:
 - Analog multiline telephones with a modem data station connected to a General-Purpose Adapter (GPA).
 - MLX telephones with either a modem data station connected using an MFM or a digital data station connected using an ISDN terminal adapter.
 - Digital data/video equipment (such as G4 FAX, and personal or group video systems) connected either directly to an MLX port or connected to an MLX port by way of an ISDN terminal adapter.

Forms Needed

Whether you are planning data options for a new system or modifying an existing system, you record data communications planning information by making additional entries on forms already completed earlier in this book, and on the appropriate data forms shown in [Table 5-2](#). Duplicate the master data forms in [Appendix C](#), “[Data Forms](#),” and work on the copies. Use the forms listed in [Table 5-3](#), as needed. See the application note, *MERLIN LEGEND Communications System Modem Pooling*, for details.



NOTE:

Behind Switch mode is not included in these instructions. It works the same way as Key mode.

Table 5-2. Data Forms

To Plan New or to Modify Existing Systems...	Use These Forms...
Trunk assignments	1a, Modem Data Station 1b, ISDN Terminal Adapter Data Station
Feature assignments	1a, Modem Data Station 1b, ISDN Terminal Adapter Data Station
Data hunt groups	2, Data Hunt Groups
Digital data and/or video stations	3, Digital Data/Video Station

Table 5-3. System Forms

To Plan...	Use These Forms...
Extension jack connections ¹ Modem data stations ISDN terminal adapter data stations Local host computer connections LAN workstation access connections Modem/ISDN terminal adapter pools ¹	2a, System Numbering: Extension Jacks (for all configurations)
Line/Trunk assignments	2a, System Numbering: Extension Jacks 2b, System Numbering: Digital Adjuncts 2c, System Numbering: Line/Trunk Jacks
Feature assignment	2a, System Numbering: Extension Jacks 2b, System Numbering: Digital Adjuncts 4d, MLX Telephones 4b, Analog Multiline Telephone 4e, MFM Adjunct: MLX Telephone 4h, ETR Telephones 4j, MLS Telephones 5b, Direct-Line Console (DLC): Digital 5c, MFM Adjunct: DLC
Dial-out code (Hybrid/PBX only) ARS Facility Restriction Level (Hybrid/PBX only)	2c, System Numbering: Line/Trunk Jacks 3f, Automatic Route Selection Tables 3g, Automatic Route Selection Default and Special Numbers Table
Data hunt groups	2c, System Numbering: Line/Trunk Jacks 2d, System Numbering: Special Renumbers 7d, Group Calling

¹ You must make an entry for extension jack connections.

Assigning Extension Jacks

Following some guidelines about digital extension jacks, this section contains procedures to plan extension jack connections for the following:

- Modem data-only stations
- ISDN terminal adapter data-only stations
- Local host computer data stations
- LAN workstations
- Video systems (personal or group)

For each type of data station, planning how the data equipment connects to extension jacks on the control unit involves the following tasks:

1. Review Form 2a, on which you entered codes (A for analog, D for digital, T for tip/ring, and E for enhanced tip/ring), and find the telephone type and the user, location, or function for each data station to be connected. [Table 5-4](#) lists extension jack types, the corresponding module types, and the equipment that can be connected.
2. Add the extension jack assignments to Form 2a.

Table 5-4. Extension Jack Types

Jack Type	Module Type	Connects...
Analog	008 (LS) 408 (LS-ATL) 408 GS/LS	Analog multiline telephones (including analog voice-and-data stations with a modem connected through a GPA)
Digital	008 MLX 016 MLX 408 GS/LS-MLX 408 GS/LS-ID-MLX	MLX telephones (including MLX voice-modem data stations) MLX telephones (including MLX voice and ISDN terminal adapter stations) ISDN terminal adapter data terminals (such as PCs) Video systems (personal or group)
ETR or Tip/ring	016 ETR ¹ 412 LS-ID-ETR ² 012 (T/R) 016 (T/R) 008 OPT	Fax machines Modem data-only stations

1 Only ports 11–16 can be programmed T/R.

2 Only ports 9–12 can be programmed as T/R.

Before you assign extension jacks for ISDN terminal adapter data stations, review the guidelines in the next section, "[Guidelines for Digital Extension Jacks](#)."

Guidelines for Digital Extension Jacks

Although only one logical ID is assigned to each digital extension jack, the system automatically assigns two extension numbers:

- The first extension number shown on Form 2a is assigned to an MLX telephone connected to the extension jack.
- The second extension number assigned to each jack is reserved for an adjunct, such as an ISDN terminal adapter data terminal or desktop video endpoint, connected to the MLX telephone.
- If a personal or group video system is connected to the MLX port, extension numbers are assigned to the video system for use in 2B Data connections.

Both extension numbers are assigned automatically, whether or not the extension includes an ISDN terminal adapter. Calls can be placed to both extension numbers independently. Note that an MLX extension cannot have both an ISDN terminal adapter and an MFM.

Also, when configuring digital data equipment connections to an MLX port, the following requirements and/or restrictions must be applied:

- When using a 7500B data module as an ISDN terminal adapter, and it is the only ISDN terminal adapter data station on the MLX port (no MLX telephone is connected), a 440A4 terminating resistor adapter must be configured to provide 100-ohm termination for each transmission pair. The 7500B data module does not provide termination.
- An MLX telephone is independent from the ISDN terminal adapter; however, the telephone may cause channel conflict between the telephone and the ISDN terminal adapter when the telephone is voice-signaled while active on a call. If a slight chance of data call blocking is unacceptable, an MLX telephone should not be connected to an ISDN terminal adapter used in a data station configuration.
- The maximum cord length from an MLX telephone to an ISDN terminal adapter is 80 feet (24 meters). This should be considered if you plan to use the voice capability of a port by connecting an MLX telephone far from the ISDN terminal adapter.
- An ISDN terminal adapter that does not support 2B Data should not be connected to an MLX port that has been programmed as a 2B Data port.

Modem Data-Only Stations

A modem data-only station consists of a data terminal connected to the control unit using an internal or external modem. This station does not include a telephone.

Assign a tip/ring extension jack on an 012 (T/R), 016 (T/R), or 008 OPT module; or, in Release 7.0 and later systems, to a port programmed for tip/ring operation on a 412 LS-ID-ETR or 016 ETR module. Either an on- or off-premises extension can be connected to an 008 OPT module.

Planning Form Instructions

Record the extension jack assignments for modem data stations on Form 2a, System Numbering: Extension Jacks:

1. In the Jack Type column, make sure there is a T next to the number for each tip/ring extension jack.
2. In the Person, Location, or Function column, write **modem** and then identify each modem data station by person, location, or function.

ISDN Terminal Adapter Data-Only Stations

An ISDN terminal adapter data-only station consists of a PC or a data terminal connected to an ISDN terminal adapter. Each ISDN terminal adapter data station connects to a digital extension jack on an 008 MLX, 408 GS/LS-MLX, 408 GS/LS-ID-MLX, or 016 MLX (Release 7.0 and later) module.

Planning Form Instructions

Record the extension jack assignments for ISDN terminal adapter data stations on Form 2a, System Numbering: Extension Jacks:

1. In the Jack Type column, make sure there is a D next to the number for each digital extension jack.
2. In the Person, Location or Function column, write ISDN-TA and identify each ISDN terminal adapter data station by person, location, or function.
3. Fill in Form 2b with the extension number of the ISDN terminal adapter.

Local Host Computer Data Stations

A local host computer data station consists of a local host computer, a data terminal for that computer, and one or more ISDN terminal adapters and/or modems.

Assign each ISDN terminal adapter used for access to a host computer to a digital extension jack on an 008 MLX, 408 GS/LS-MLX, 408 GS/LS-ID-MLX, or 016 MLX (Release 7.0 and later) module. Assign each modem to a tip/ring extension jack on an 012 (T/R), 016 (T/R), or 008 OPT module; or, in Release 7.0 and later systems, to a port programmed for tip/ring operation on a 412 LS-ID-ETR or 016 ETR module.

If you have a limited number of ISDN terminal adapters or modems to share among many users, assign some or all of the modems or ISDN terminal adapters to a DHG. In this way, users can access all the devices in the DHG by dialing one extension number.

Users access the computer by placing a data call to the extension number for either an ISDN terminal adapter or modem (or DHG)—depending on the user's type of data station—that is assigned for communication with the local host computer.

Planning Form Instructions

Record the extension jack assignments for local host computer access extensions on Form 2a, System Numbering: Extension Jacks.



NOTE:

Before you assign extension jacks for a local host computer, review the guidelines in "[Guidelines for Digital Extension Jacks](#)," earlier in this section.

1. For each digital extension jack used to connect an ISDN terminal adapter:
 - a. In the Jack Type column, make sure there is a **D** next to the number for each digital extension.
 - b. In the Person Location, or Function column, write **Terminal Adapter-host**.
2. For each tip/ring extension jack you plan to use to connect a modem:
 - a. In the Jack Type column, make sure there is a **B** next to the number.
 - b. In the Person, Location or Function column, write **modem-host**.

LAN Workstations

A Local Area Network (LAN) consists of workstations (PCs) connected together to share resources. The system connects to the LAN through a workstation that functions as a gateway, providing ports for modem and ISDN terminal adapter connections.

Assign each ISDN terminal adapter used for access to a LAN workstation to a digital jack on an 008 MLX, 408 GS/LS-MLX, 408 GS/LS-ID-MLX, or 016 MLX (Release 7.0 and later) module. Each modem must be connected to a tip/ring extension jack on an 012 (T/R), 016 (T/R), or 008 OPT module; or, in Release 7.0 and later systems, to a port programmed for tip/ring operation on a 412 LS-ID-ETR or 016 ETR module.

If you have a limited number of ISDN terminal adapters or modems to share among many users, assign some or all of the modems or ISDN terminal adapters to a DHG. In this way, users can access all the devices in the DHG by dialing one extension number.

Users access the computer by placing a data call to the extension number for either an ISDN terminal adapter or modem (or DHG)—depending on the user's type of data station—that is assigned for communication with the local host computer.

Planning Form Instructions

Record the extension jack assignments for access to a workstation on a LAN on Form 2a, System Numbering: Extension Jacks.

1. For each digital extension jack used to connect an ISDN terminal adapter:
 - a. In the Jack Type column, make sure there is a **D** next to the number for each digital extension.
 - b. In the Person Location, or Function column, write **Terminal Adapter-LAN**.
2. For each tip/ring extension jack you plan to use to connect a modem:
 - a. In the Jack Type column, make sure there is a **B** next to the number for each tip/ring extension jack used to connect a modem.
 - b. In the Person, Location or Function column, write **modem-LAN**.

Video Systems

Video systems may connect to an MLX port on the MERLIN LEGEND System either directly through a BRI interface, or by way of a v.35 interface and an ISDN terminal adapter.

Assign each video system that is connected directly to the MLX port, or connected to an ISDN terminal adapter that supports 2B Data, to one digital jack configured as a 2B Data port on an 008 MLX, 408 GS/LS-MLX, 408 GS/LS-ID-MLX, or 016 MLX (Release 7.0 and later systems) module.

Assign each video system that is connected to an MLX port by way of an ISDN terminal adapter that does not support 2B Data to two separate digital jacks configured as 1B Data ports on an 008 MLX, 408 GS/LS-MLX, 408 GS/LS-ID-MLX, or 016 MLX (Release 7.0 and later systems) module.

Planning Form Instructions

Record the extension jack assignments for video systems on Form 2a, System Numbering: Extension Jacks.

1. In the Jack Type column, make sure there is a **D** next to the number for each digital extension.
2. In the Person, Location, or Function column, enter the type of equipment connected.

Assigning Lines/Trunks to Data and Video Stations

The following types of outside lines/trunks are used to make and receive data calls to and from data stations outside of the system:

- **Loop-Start (LS).** This is the standard line/trunk for homes and small businesses, and can be used to communicate with outside modem data stations. Video calls are not made over loop-start lines/trunks. Loop-start lines/trunks are the least expensive lines/trunks in some areas but have the following disadvantages:
 - They do not protect against glare, a condition that occurs when an outside call is made at the same time that an incoming call arrives on the same line/trunk.
 - They may not provide reliable far-end disconnect for toll restriction.



SECURITY ALERT:

Toll fraud can occur when loop-start lines/trunks are used with unreliable disconnect. If the calling party stays on the line after the called party hangs up, the central office returns a dial tone at the conclusion of the call enabling the caller to place another call as if it were being placed from your company.

- **Ground-Start (GS).** This line/trunk is preferred for communication with outside modem data stations. Ground-start lines/trunks provide improved signaling and reliable far-end disconnect for secure toll restriction. Video calls are not made over ground-start lines/trunks.

The following kinds of outside ground-start or loop-start lines/trunks can be used for data communications:

- Basic lines/trunks
- Wide area telecommunications service (WATS)
- 800 service (inbound WATS)
- Foreign exchange (FX)

Ground-start/loop-start lines/trunks connect to ground-start/loop-start jacks on the following types of modules in the control unit:

- 800 GS/LS
- 400 GS/LS/TTR
- 408 (LS lines/trunks only)
- 408 GS/LS
- 400 (LS lines/trunks only)
- 412 LS-ID-ETR (LS lines/trunks only)

5 Data Communications

Assigning Lines/Trunks to Data and Video Stations

5-26

- 800 (LS) (LS lines/trunks only)
- 408 GS/LS-MLX
- 408 GS/LS-ID-MLX
- 800 GS/LS-ID

- **Analog/Digital Tie.** This trunk type “ties” two telephone switching systems together, providing access to all telephones or data equipment on each system. Analog Tie trunks are used for data communication with modem data stations connected to a system at a different location, such as a different floor of a building, a different building, or a different city or state. Analog Tie trunks connect to a jack on a 400EM module in the control unit. Video calls are not made over analog Tie lines/trunks.

Digital Tie trunks are used for digital data communications, such as G4 fax and videoconferencing, with digital data/video stations connected to a system at a different location, such as a different floor of a building, a different building, or a different city or state. Digital Tie trunks are emulated by T1 facilities connected to a 100D module in the control unit. Video and digital data calls may be made over digital Tie lines/trunks.

- **Direct Inward Dial (DID).** Incoming calls reach specific individuals or facilities in the system without the help of a system operator. DID trunks are available only in Hybrid/PBX mode. A DID trunk is used to receive incoming calls from outside modem data stations. It is not used for outgoing calls. A DID trunk connects to a jack on an 800 DID module in the control unit. Video calls are not made over DID lines/trunks.
- **Digital Signal 1 (DS1).** This facility carries digital signals in the DS1 format. A DS1 facility can be used for communication with outside digital or modem data stations, including video systems. A DS1 facility connects to the jack on a 100D module in the control unit. Even though there is only one physical jack, the 100D module supports up to 24 logical endpoints for voice and data calls; each DS0 channel in the DS1 signal corresponds to a trunk or logical ID.

A DS1 facility provides either T1 (including T1 Switched 56 for digital data/video calls) or PRI access:

- **T1** (factory setting). The 24 channels on a T1 facility can be programmed individually in any combination to emulate a loop-start, ground-start, E&M tie, DID, or Switched 56 digital data trunk, so a single 100D module can replace 24 outside lines/trunks. When T1 Switched 56 service is used, high-speed video connections at data rates of 56-kbps per channel (112-kbps for 2B Data) are possible.
- **PRI.** The standard format for ISDN services provided by connection to a 5ESS central office switch or a 4ESS or DEFINITY toll switch. PRI facilities provide several benefits, including increased speed of data calls to an outside destination, INFO-2 automatic call identification (ANI) service, dynamic B-channel assignment, improved toll restriction, reliable indication of far-end disconnect, and improved SMDR. Twenty-three channels can be programmed

5 Data Communications

Assigning Lines/Trunks to Data and Video Stations

5-27

for individual services (Channel 24 is reserved for signaling purposes). PRI facilities may also be used for high-speed video calls at data rates of up to 64-kbps per B-channel (128-kbps total for 2B Data).

The 100D module supports any combination of the following AT&T Switched Network services:

- ACCUNET Switched Digital Service for 56-kbps and 64-kbps restricted and 64-kbps clear (unrestricted) circuit-switched data calls (PRI only)
 - ACCUNET Switched 56 Service for 56-kbps (restricted or unrestricted) data calls (T1 only)
 - Megacom 800 for incoming domestic toll-free voice calls
 - Megacom WATS service for outgoing domestic long-distance voice calls
 - Software-Defined Network (SDN) for circuit-switched voice and data calls at up to 56 kbps
- In Release 4.2 and later systems, these MCI services are also available:
 - MCI PRISM
 - MCI Vnet
 - MCI 800
 - MCI 900
 - In Release 4.2 and later systems, these local exchange carrier services are also available:
 - DMS Private
 - DMS INWATS
 - DMS OUTWATS
 - DMS FX
 - DMS Tie Trunk
 - **NI-1 BRI.** Basic Rate Interface (BRI) is a protocol within the ISDN standard that provides digital voice, data, and video connectivity. NI-1 BRI facilities connect to a jack on the 800 NI-BRI module, with each facility providing two B-channels per jack (total of 16 NI-1 BRI channels per 800 NI-BRI module). BRI facilities provide data rates of up to 64-kbps clear (unrestricted) circuit-switched data calls per B-channel (128-kbps total for 2B Data).

5 Data Communications

Assigning Lines/Trunks to Data and Video Stations

5-28

To assign lines/trunks to data stations, you decide on the types of line buttons that are assigned to the data communications equipment at each data station. The data stations are:

- Analog voice and modem data stations and MLX voice and modem data stations
- MLX voice and ISDN terminal adapter data stations, including telephones
- Modem data-only stations
- ISDN terminal adapter data-only stations
- Digital data/video stations

The system treats each data station, except for analog voice and modem data stations, as an extension with a 34-button telephone.

When you choose the mode of operation (Key, Behind Switch, or Hybrid/PBX), Intercom (ICOM) or System Access (SA) buttons are assigned automatically to every extension connected to the control unit. However, you can customize the system by changing the factory-set assignments and reassigning line buttons. The number and types of buttons assigned depends on the mode chosen and the type of extension jack you are using.



NOTE:

Trunks cannot be independently assigned to analog voice and modem data stations. The line/trunk assignment for the telephone also includes the modem extension; therefore, these instructions are not used for these types of data stations.

Forms Needed

- Data Form 1a, Modem Data Stations
- Data Form 1b, Data Stations
- Form 4e, MFM Adjunct: MLX Telephone
- Form 5c, MFM Adjunct: DLC

Planning Form Instructions

You should have already filled out preliminary information on Forms 4e and 5c when you planned voice communications. The lines/trunks for MLX telephones have already been assigned.

5 Data Communications

Assigning Lines/Trunks to Data and Video Stations

5-29

There are two different forms for data stations:

- **Data Form 1a.** Use this form for modem data-only stations and for modems used to communicate with the local host computer and to communicate with a workstation on a LAN.
- **Data Form 1b.** Use this form for ISDN terminal adapters and ISDN terminal adapter data stations used to communicate with the local host computer or with a workstation on a LAN.

Make enough copies of each data form so that you can complete one form for each data station. Do the following:

1. From Form 2a, System Numbering: Extension Jacks, obtain the identification information for each data station.
2. Record the information on the appropriate data form (2a or 2b) for each data station and for each modem and ISDN terminal adapter used to communicate with a local host computer or with a workstation on a LAN:
 - a. In the Logical ID space, write the logical ID for each extension.
 - b. In the Extension No. space, write the extension number for each extension.
 - c. In the Person or Location space, write the name of the person or the location of the data equipment.
 - d. Under the Data Station Use heading, indicate the purpose of the data station by checking one of the following boxes: Individual use, Local host computer, or LAN workstation.

Assigning Line Buttons in Hybrid/PBX Mode

The line buttons you can assign to data stations are as follows:

- **System Access Ring (SA Ring).** Used to make and receive inside and outside data calls. To make outside calls, the user selects an outside line/trunk by dialing either the code for Automatic Route Selection (ARS) or the dial-out code for the trunk pool. Users at ISDN terminal adapter data stations and video endpoints can also dial the line/trunk number (801-880) to select an outside line/trunk.
- **Personal Line.** Used to make and receive outside data calls from a data station on a specific outside line/trunk. A personal line is an outside line/trunk assigned to a line button on one or more data or voice stations. The outside line/trunk cannot be a member of a pool.

To dedicate an outside line/trunk for data calls and have the calls automatically answered by data equipment, do not assign the same outside line/trunk to both data equipment and telephones because modems answer voice calls as data calls.

5 Data Communications

Assigning Lines/Trunks to Data and Video Stations

5-30

On analog voice-and modem data stations, a personal line can be used to receive incoming calls. A personal line can be used for outgoing calls by selecting the line button on the analog multiline telephone, dialing, and then activating the modem connected through a GPA.

On ISDN terminal adapter data stations, a personal line can be used to make and receive outside data calls. To select the line/trunk for an outgoing call, the caller dials the line/trunk number (801–880). To allow the user at an ISDN terminal adapter data station access to the digital network for making and receiving calls to outside digital data stations, assign PRI, NI-1 BRI, or T1 Switched 56 (including T1-Tie lines using Switched 56 service) facilities as personal lines.

- **Pool.** Used when you want the voice and data station to make and receive outside data calls on a specific trunk pool (for example, a pool with PRI facilities) without dialing a dial-out code. The Pool button is used to make and receive only outside calls. Automatic Line Selection should be set to the Pool button in order to place calls on it.



NOTES:

- Do not assign System Access Voice (SA Voice) buttons to data communications equipment.
- You must use PRI facilities with a digital data service such as ACCUNET Switched Digital Service, a Software Defined Network (SDN), T1 Switched 56 facilities, or NI-1 BRI facilities for digital data calls.
- T1 facilities that are not using Switched 56 service can be used for modem data and analog voice calls and can be assigned to telephones to allow the voice user to make and receive voice calls using these types of facilities.

The following line button assignments are factory set for Hybrid/PBX mode and are prerecorded on the Button Diagram on Data Forms 1a and 1b:

- One System Access Originate Only (SA Orig Only) button and two System Access Ring (SA Ring) buttons are assigned to all data equipment connected to a tip/ring port on an 012 (T/R), 016 (T/R), or 008 OPT module; or, in Release 7.0 and later systems, to a port programmed for tip/ring operation on a 412 LS-ID-ETR or 016 ETR module.
- One System Access Originate Only (SA Orig Only) button, one System Access Ring (SA Ring) button, and a System Access Voice (SA Voice) button are assigned to all data equipment connected to a digital extension jack on an 008 MLX, 408 GS/LS-MLX, 408 GS/LS-ID-MLX, or 016 MLX (Release 7.0 and later systems) module. Remove the SA Voice button (see Form 5c, page 1).

5 Data Communications

Assigning Lines/Trunks to Data and Video Stations

5-31

The factory settings can be changed; however, the settings should be adequate to meet most user needs, since System Access lines can be used to make both inside and outside data calls. Each data extension must have at least one SA button, or two SA buttons for making 2B Data calls. If making 2B Data calls with two personal line buttons, you must also have two SA buttons.

If you want an ISDN terminal adapter data station to make and receive outside data calls on a specific outside line/trunk, assign a personal line button. To make calls on a personal line, set the Automatic Line Selection to that line.

Assigning Pools and Lines/Trunks (Hybrid/PBX Mode Only)

If you want the voice and data station to make and receive outside calls on a specific trunk pool, assign a Pool button.

To dedicate a specific line/trunk or pool to receive outside data calls, assign a personal line or pool to a data station or DHG.

To dedicate specific lines/trunks for use in data communications only (such as PRI channels or other special data lines), consider grouping those lines/trunks in a pool.

If the system uses ARS, follow the instructions on ARS earlier in this book to specify routes for outgoing data calls.

To restrict non-data users from dial access to data trunk pools, use the [“Pool Dial-Out Code \(Hybrid/PBX Mode Only\)”](#) instructions later in this chapter.

Forms Needed

- Form 2c, System Numbering: Line/Trunk Jacks
- Data Form 1a, Modem Data Station
- Data Form 1b, ISDN Terminal Adapter Data Station

Planning Form Instructions

Record your decisions for each data station on the Hybrid/PBX Mode Button Diagram of Data Form 1a or 1b.

1. If you want to assign personal lines to the data station, write **Personal Line** and the telephone number (from Form 2c) of the outside line on the appropriate button. For ISDN terminal adapter data stations, include the line/trunk number.
2. If you want to assign a pool to the data station, write **Pool** and the pool's extension number (from Form 2c) on the appropriate button.



NOTE:

On modem data stations from which the user does not need to make inside calls, you can assign only personal lines or pools; when going off-hook, the user or equipment gets a telephone company line/trunk by Automatic Line Selection.

Assigning Line Buttons in Key Mode

There are two kinds of line buttons you can assign to data stations used to make and receive data calls:

- **Intercom Ring.** Used to make and receive inside data calls only.
- **Outside Line/Trunk.** Used to make and receive outside data calls on a specific outside line/trunk. An outside line/trunk can be assigned to a line button on one or more data stations or voice extensions. To dedicate an outside line/trunk for data calls and have the calls automatically answered at a data station, do not assign the same outside line/trunk to data stations and to telephones, because modems answer voice calls as data calls.

For digital data stations, the outside line/trunk can be used to make and receive outside data calls. For an outgoing call, the user dials the line number (801-880) to select the line/trunk.

To allow the user at an ISDN terminal adapter data station access to the digital network for making and receiving calls to outside digital data stations, assign PRI facilities with digital data service such as ACCUNET Switched Digital Service and Software Defined Network (SDN), NI-1 BRI, or T1 Switched 56 facilities to ISDN terminal adapter data stations. If these facilities are not available, the ISDN terminal adapter data station user can make calls over the regular analog telephone network only by using a digital-to-analog modem pool, described in the application note, *MERLIN LEGEND Communications System Modem Pooling*.



NOTE:

PRI and NI-1 BRI facilities are also used for analog data and voice calls and can be assigned to telephones to allow the voice user to make and receive voice calls using these types of facilities.

The following line button assignments are factory-set for Key mode and are prerecorded on the Button Diagram on Data Forms 1a and 1b. Two Intercom Ring (ICOM Ring) buttons are assigned to the following:

- Data equipment connected to an 012 (T/R), 016 (T/R), or 008 OPT module; or, in Release 7.0 and later systems, to a port programmed for tip/ring operation on a 412 LS-ID-ETR or 016 ETR module.
- All equipment connected to a digital extension jack on an 008 MLX, 408 GS/LS-MLX, 408 GS/LS-ID-MLX, or 016 MLX (Release 7.0 and later) module.

The factory settings can be changed; however, at least one ICOM button must be assigned to each data station. To allow a user to make and receive outside data calls, you must assign an outside trunk to the data station.

To dedicate a specific line to receive outside data calls, assign an outside line/trunk to a data station, DHG, LAN workstation, or local host computer.

On a digital or analog data station, the user selects an outside line/trunk by dialing the Idle Line Preference code (usually 9) on an ICOM button. On an ISDN terminal adapter data station, the user can also select lines/trunks assigned to the extension by dialing the line number (801–880) assigned to that outside line/trunk.

It is extremely important that the factory-set Idle Line Preference (the line to which the user is connected automatically when going off-hook) not be changed. The user must be connected to an intercom line to activate features such as Privacy or to select an available outside line/trunk by dialing the Idle Line Preference code.

Planning Form Instructions

Using Form 2c, System Numbering: Line/Trunk Jacks as reference, record your decisions for each data station on the Key mode Button Diagram of Data Form 1a or 1b. If you want to assign outside lines/trunks to the data station, write the telephone number (from Form 2c) of the outside line/trunk on the appropriate button. For ISDN terminal adapter data stations, include the line/trunk number.

Assigning Features to Data Stations

Many of the features used for voice calls (as described earlier in this guide) can also be assigned to data stations. This section describes these features and how to assign them to each ISDN terminal adapter or modem data station. This includes: modem data stations with an MLX telephone using an MFM, ISDN terminal adapter data stations with a telephone, and modem and ISDN terminal adapter data-only stations (data stations with no telephone).



NOTE:

Features cannot be independently assigned to modem data stations connected to analog multiline telephones using a General-Purpose Adapter (GPA). The feature assignment for the telephone also includes the modem; therefore, the following planning instructions are not used for these types of data stations.

The following optional features can be assigned to data stations:

- **Account Code Entry.** This feature allows tracking of outgoing data calls for billing, forecasting, or budget reports.
- **Auto Answer All.** This feature allows a modem with automatic answering capability to answer data calls when the user is away from the data station. Supports analog voice and modem data stations only.

- **Automatic Route Selection** (Hybrid/PBX Mode Only). This feature routes calls over outside lines/trunks according to the number dialed and the lines/trunks available. Therefore, the system can be programmed to select the least expensive route for each data call over either PRI, NI-1 BRI, or T1 Switched 56 facilities.
- **Calling Restrictions.** These features inhibit line access, and allow companies to control and manage communications costs for outgoing data calls.
- **Data Status.** This button allows monitoring of station activity (busy, not busy) at any data station. Although this feature is similar to having an Inside Auto Dial or Signaling button because it lights the green LED to indicate extension-busy status, pressing the button has no effect. It does not dial the data extension number. Thus, the button does not interfere with a data call in progress, unlike an Auto Dial button, which dials its programmed number.
- **Personal Lines.** This feature provides direct access from an ISDN terminal adapter data station to outside lines that support the PRI, NI-1 BRI, or T1 Switched 56 interface.
- **Idle Line Preference.** This feature automatically selects the first available line for data calls.
- **Last Number Dialed.** This feature automatically places a call to the last number dialed from that data station. The dialing sequence must include dial-out code for outside calls.
- **Personal Speed Dial.** These 2-digit numbers are programmed for quick dialing of frequently used numbers. The dialing sequence requires a dial-out code for outside calls.
- **Privacy.** This feature prevents loss of data by ensuring that data transmission is not interrupted accidentally. Privacy is automatic for data calls on ISDN terminal adapter data stations and on analog voice and modem data stations. Privacy is activated manually on modem data-only stations.
- **System Speed Dial.** This feature allows quick dialing of numbers that are frequently used systemwide. The dialing sequence requires a dial-out code for outside calls. The System Speed Dial feature is programmed systemwide for both voice and data stations. Follow the instructions earlier in this book to assign System Speed Dial codes to data station users.



NOTE:

Certain system (voice) features interfere with data connections. The following system features must be disabled for the data station:

- Voice Announce
- Call Waiting
- Automatic Callback

For detailed information about these features, refer to the *Feature Reference*. For information on planning for features not described in this section, use the guidelines presented in the appropriate sections earlier in this guide.

Forms Needed

- Data Form 1a, Modem Data Station
- Data Form 1b, ISDN Terminal Adapter Data Station
- Form 4e, MFM Adjunct: MLX Telephones
- Form 5c, MFM Adjunct: DLC

Pool Dial-Out Code (Hybrid/PBX Mode Only)

Use these instructions only if the system is operating in Hybrid/PBX mode.

The factory setting is for all extensions, including data stations, to be restricted from using *all* dial-out access codes. You can unrestrict data stations to allow the user access to one or more trunk pools by dialing the pool dial-out code.

The dial-out code restriction places data calls only on specific trunk pools. For example, you may want to restrict users to trunk pools that are made up of special data lines such as PRI channels used for data services, or to reserve other trunk pools for voice communications only.

Planning Form Instructions

Use the Optional Features section of Data Form 1a or 1b for each data extension to record your decisions:

1. In the Optional Features section, under the "Pool Dial-Out Code Restriction" heading:
 - Check Unrestricted from following codes and list the codes in the space provided for unrestricted use.
 - Check Restricted from following codes and list the codes in the spaces provided for restricted use. The factory setting is restricted for all codes.
2. Use Form 2c, System Numbering: Line/Trunk Jacks to locate the dial-out codes for each pool that the data station is restricted from using. Write the dial-out codes on the lines below the Yes box.

Calling Restrictions

When the system is first set up, all data stations are restricted. This means that only inside (intercom) calls may be made, local and long-distance calls may not be placed from any data station. You can unrestrict selected data stations, however, to allow local and long-distance calls.

Planning Form Instructions

Use the Optional Features section of Data Form 1a or 1b for each data station to record your decisions. Under the Call Restriction heading, do *one* of the following:

- If you do not want calling restrictions for this data station, check the Unrestricted box.
- If you want the data station restricted from making any outside calls, check the Outward Restrict box (factory setting).
- If you want the data station restricted from making long-distance calls (intercom and local calls can be made), check the Toll Restrict box.

Forced Account Code Entry

The Forced Account Code Entry feature is used for billing or for tracking data calls by requiring data extension users to enter account codes (1 to 16 digits) for outside calls. Assign this feature to data stations so that you can associate outgoing data calls with specific client accounts.



NOTE:

Account codes cannot be used to track incoming calls to data stations.

Planning Form Instructions

To record your decisions, use the Optional Features section of Data Form 1a or 1b for each data station. Under the Forced Account Code Entry heading, do *either* of the following:

- If the user must enter an account code for outgoing calls, check the Yes box.
- If you do not want the feature assigned to the data station, check the No box (the factory setting).

ARS Facility Restriction Level (Hybrid/PBX Mode Only)

Use these instructions only if the system is operating in Hybrid/PBX mode.

If the system uses ARS for data calls, you can assign a Facility Restriction Level (FRL) to each data station. This value (0–6) corresponds to the FRL assigned to each route and is used to restrict data users from access to specific routes. Before restricting a data station, review the values assigned to each route.

To restrict a data station from specific routes, assign an FRL value lower than the route's lowest value. (Values equal to or greater than the route's values allow data extension users to access those routes.) A value of 0 is the most restrictive, and a value of 6 is the least restrictive. The factory setting is 3.

For example, to give a modem data station unlimited use of any ARS route, assign a value of 6. If you have ISDN terminal adapter data stations, assign a value of 0 to prevent users from inadvertently using ARS to select an analog line for outside data calls.

Planning Form Instructions

1. Using Form 3f, Automatic Route Selection Tables, and Form 3g, Automatic Route Selection Default and Special Numbers Table, review the values assigned to the routes.
2. For each data station, to record your decisions about Facility Restriction Level, do *either* of the following in the Optional Features section of Data Form 1a or 1b:
 - Check 3 to keep the factory setting.
 - To change the setting, write the value (0–6) for the ARS Facility Restriction level you want to assign to each data station.

System Speed Dial Codes

To avoid giving the telephone number of a remote computer to modem pool users, assign a System Speed Dial code to the telephone number. Users can dial this 3-digit code to place data calls to the remote computer.

For data calls, the telephone number programmed for a System Speed Dial code must include the access code (the dial-out code or the ARS dial-out code) if required.

To specify that the remote computer's telephone number does not appear on call reports, use the "[System Speed Dial](#)" instructions in [Chapter 4](#) of this guide.

Creating Data Hunt Groups

Use these instructions if the system has a group of modems or ISDN terminal adapters.

DHGs are data calling groups that provide uniform call distribution among a group of modems or a group of ISDN terminal adapters. DHGs support the following:

- Modem pools
- Dedicated lines for data service
- A local host computer
- A workstation that functions as a gateway on a LAN

For more information, see the "[Assigning Extension Jacks](#)," earlier in this chapter. For information on modem pools, see the application note, *MERLIN LEGEND Communications System Modem Pooling*.

Guidelines

Use the following guidelines for the procedure in this section:

- Members of a DHG must be extension jacks of the same type: all analog or all MLX.
- You can assign up to 32 DHGs or calling groups, or a combination of both types. Each DHG can have a maximum of 20 members and each data station can be a member of only one DHG.
- You can designate particular lines/trunks or pools (Hybrid/PBX mode only) to ring directly into a DHG. Incoming calls on a given line/trunk, however, can be directed to only one DHG.
- Extension numbers 770–791 and 7920–7929 are reserved automatically for calling groups and DHGs. If you want to change the extension numbers assigned to a DHG, see the information about reassigning extension numbers described in [Chapter 2, “Control Unit Configuration.”](#) The same considerations apply to data stations and voice extensions.

Forms Needed

- Form 2a, System Numbering: Extension Jacks
- Form 2c, System Numbering: Line/Trunk Jacks
- If the system includes voice calling groups, Form 7d, Group Calling
- If you plan to renumber the factory-set extensions, Form 2d, System Numbering: Special Renumbers

Planning Form Instructions

Make enough copies of Data Form 2, Data Hunt Groups, for the number of data hunt groups you plan. For each DHG:

1. Write the group number (1–32) in the Group Number space.
2. Write the name of the group in the Group ID space.
3. Write the factory-set extension number for the DHG in the space provided.



NOTE:

Check all pages of Form 7d to be sure that you have not assigned the extension to a voice calling group.

4. If you want to reassign the factory-set extension number for the DHG, write the new number in the Renumber to space. Also, write the new extension number you want to reassign in the calling group or DHG on Form 2d, System Numbering: Special Renumber.
5. Under the Purpose of Group heading, indicate the group use: local host computer access workstation, LAN access, and so forth.

6. In the Stations area, write the extension number of each member of the group in the Ext. No. column and the name of the person or location in the Person or Location column.
7. In the Trunks or Pool area, for each line/trunk or pool that you want to ring directly into the DHG, write the line/trunk number or pool extension number next to the logical ID in the Trunk or Pool column. (See Form 2b for the line/trunk numbers and Form 2c for the pool extension number.)

Digital Data/Video Stations

Use these instructions if the system has digital data/video endpoints.



NOTE:

See the Network Reference for information on digital data/video stations on a private network.

Digital data/video endpoints provide access to voice, as well as high speed digital data and video services over PRI, NI-1 BRI, or T1 Switched 56 facilities. Incoming data/video calls can be received using:

- Dial Plan Routing (PRI and T1 Switched 56 Data)
- Tie Line Routing (PRI and T1 Switched 56 Data)
- Personal Lines

Outgoing data/video calls can be placed using:

- Pool Access
- Automatic Route Selection (ARS)
- Personal Lines

For more information, see the "[Assigning Extension Jacks](#)," earlier in this chapter.

Forms Needed

- Form 2a, System Numbering: Extension Jacks
- Data Form 3, Digital Data/Video Stations

Planning Form Instructions

Make enough copies of Data Form 3, Digital Data/Video Stations, for the number of digital data/video stations you plan. For each:

1. From Form 2a, System Numbering: Extension Jacks, obtain the identification information for each digital data/video station.
2. Record the information on Data Form 3, Digital Data/Video Stations.
 - a. In the Logical ID space, write the logical ID for each extension.
 - b. In the Extension No. space, write the extension number for each extension.
 - c. In the Equipment, Person, Location space, write the type of data/video endpoint, and the name of the person or the location of the equipment.
3. In the Data/Video Type space, place a check mark in the 1B or 2B column to indicate whether this endpoint uses one or two B-channels.
4. In the Digital Facilities space, enter the method used to access incoming and outgoing facilities.
 - a. In the Digital Facilities In space, enter one of the following for incoming data/video calls:
 - If personal lines are used to receive data/video calls, enter the line/trunk number for each personal line. For example, 801/802.
 - If Dial Plan Routing is used to route incoming data/video calls (PRI and T1 Switched 56 facilities only), enter Dial Plan Routing.
 - If Tie Line Routing is used to route incoming data/video calls (PRI and T1 Switched 56 facilities only), enter Tie Line Routing.
 - b. In the Digital Facilities Out space, enter one of the following for outgoing data/video calls:
 - If personal lines are used to place outgoing data/video calls, enter the line/trunk number for each personal line—for example, 801/802.
 - If Pool Access is used to place outgoing data/video calls, enter the pool access number—for example, 890.
 - If Automatic Route Selection (ARS) is used to place outgoing data/video calls, enter the ARS access code. The ARS access code factory setting is 9.

Modifications

6

This chapter contains instructions for adding trunks, auxiliary equipment, or more telephones to an existing system. It includes the following:

- The actions that you must take to add to the system.
- The interrelated options or features that you should consider.
- The forms that must be revised or completed.

To modify the system, perform the following tasks:

1. Decide what to change and identify the programming needed.
2. Complete (or revise) the appropriate planning forms.
3. Program the modification using instructions in *System Programming*.



NOTE:

If you need to modify a private network (such as adding a new switch to the network or modifying one or more switches in the network), see the *Network Reference* for information.

Preparation

To prepare for modifying the system:

1. Collect the package of completed planning forms. Although you may need to revise only one or two forms, you should have all completed forms available for reference.
2. Review [Chapter 1](#), "[Before You Begin](#)," for details on preparation for planning activities.

3. Before revising the forms, analyze and document the changes planned. For example:
 - If adding extensions to the system, revise the floor plan to show the location of the new telephones and the kind of equipment to be used.
 - If activating a feature such as System Speed Dial, survey employees to identify the numbers that should be programmed into the speed dial file.
4. Review security information in [Appendix A](#), "[Customer Support Information](#)," for details on how to minimize the risk of toll fraud.

Adding to the System

Adding to the system is defined as increasing its capacity or capability. This increase may mean adding more or different kinds of lines/trunks, connecting auxiliary equipment, or installing more telephones, consoles, or T/R equipment.

Forms Needed

- 1, System Planning
- 2a, System Numbering: Extension Jacks
- 2c, System Numbering: Line/Trunk Jacks

Planning Form Instructions

1. Determine the specific type of line/trunk, auxiliary equipment, or telephones to be added. Then determine the type of line/trunk and/or extension module needed to support the additional equipment. Consider the following as you choose the modules:
 - DS1 connectivity configured for T1 operation provides 24 channels.
 - T1-Tie trunks may be configured to use Switched 56 service.
 - NI-1 BRI service provides 16 channels per 800 NI-BRI module.
 - If you are planning for Remote Access, at least one module with touch-tone receivers (TTRs) must be installed.
 - If analog multiline telephones require either voice and data or Voice Announce when the telephone is busy, two consecutive telephone jacks are required.
 - If you are connecting T/R equipment to the 008 (ATL), 408 (LS-ATL), or 408 GS/LS modules, a GPA is required.
 - If you are connecting T/R equipment to the 016 ETR or 412 LS-ID-ETR module (Release 7.0 and later systems), you must program the port for tip/ring operation.

2. On Form 1 (page 2), System Planning, review the completed Control Unit Diagram and determine whether the module type needed is present. Do one of the following:
 - If the module is not in the control unit, skip to Step 4.
 - If the module type needed is already in the control unit, proceed to Step 3.
3. Determine whether there are jacks available on the module for the new line/trunk, auxiliary equipment, or telephone by referring to Form 2a, System Numbering: Extension Jacks, or Form 2c, System Numbering: Line/Trunk Jacks.

Do either of the following:

- If there are sufficient jacks available on an existing module, plan to connect the added line/trunk, auxiliary equipment, or telephone to them. Skip to Step 6.
 - If no jacks are available, proceed to Step 4.
4. Plan the placement of the new module required to support the line/trunk, auxiliary equipment, or telephone by reviewing the guidelines that follow and deciding where the new module should be placed.
 - The power supply module must be placed in the far left slot of each carrier.
 - The processor module must be installed in Slot 0 of the basic carrier.
 - Line/trunk and/or extension modules can be placed in any order in Slots 1 through 17 (with two expansion carriers), with the following conditions:
 - Install the modules in each carrier from left to right, with no empty slots between modules.
 - If the system includes a QCC, the 008 MLX, 408 GS/LS-MLX, 408 GS/LS-ID-MLX, or 016 MLX (Release 7.0 and later systems) module that supports the QCC must be the first extension module in the control unit.
 - Place all older 008 OPT modules (Apparatus Codes 517A28–517C28) and 012 (T/R) modules (Apparatus Codes from 517C13–517F13) in carriers with ring generators installed in the power supply module. Current versions of 008 OPT modules (Apparatus Code 517D28), 012 (T/R) modules [Apparatus Code 517G13(28)], and 016 (T/R) modules (Apparatus Code 517A34) have built-in ring generators and can be mixed in carriers with the older modules that already have a generator in place. For Release 7.0 and later systems, the 412 LS/ETR and 016 ETR modules have a REN of 3 and can ring all tip/ring ports at the same time.

5. Do *either* of the following:



NOTE:

Placing additional modules in the control unit requires a recalculation of unit loads. See Appendix F, "Unit Load Calculation."

- If the control unit has an available slot to the right, and the guidelines permit placement there, proceed to Step 6.
 - If you must rearrange existing modules to accommodate the new one, skip to Step 7.
6. Revise or complete the required planning form or forms according to the directions shown in [Table 6-1](#), [Table 6-2](#), and [Table 6-3](#).
 7. If you rearrange modules in the control unit, the numbering plan reverts to the factory-set 2-digit plan. You must then reprogram the system:
 - a. Obtain a blank set of planning forms; copy them from Appendix B of this book or order them separately.
 - b. Locate the Equipment List (if available), the local telephone company line/trunk information list, the floor plan, and the Employee Communication Survey forms. If any of these materials has been revised, find both the original and revised versions.
 - c. Work through *System Planning*, beginning with [Chapter 2](#), "[Control Unit Configuration](#)."
 - d. When you have completed modifying existing forms or completing new forms, program the modification or modifications, following the instructions in *System Programming*.

Table 6-1. Adding New Trunks

If Adding...	Complete these Forms...
Loop-start or Ground-start Trunks	All columns of Form 2c, System Numbering: Line/Trunk Jacks
DS1 Trunks	All Columns of Form 2c, System Numbering: Line/Trunk Jacks and Form 3b, Incoming Trunks: DS1 Connectivity (100D Module)
NI-1 BRI Trunks	All Columns of Form 2c, System Numbering: Line/Trunk Jacks and Form 3i, Incoming Trunks: BRI Options (800 NI-BRI Module)
Tie Trunks	All columns of Form 2c, System Numbering: Line/Trunk Jacks and Form 3c, Incoming Trunks: Tie
DID Facilities	<p>All columns of Form 2c, System Numbering: Line/Trunk Jacks and Form 3d, Incoming Trunks: DID</p> <p>Consider revisions to Form 3a, Incoming Trunks: Remote Access</p> <p>Consider revisions to Form 2c, System Numbering: Line/Trunk Jacks (labels) and Forms 3e through 3g for ARS</p> <p>Button Diagram on copies of Forms 4a through 4f, and 5a through 5d</p> <p>If a personal line is assigned, consider Remote Call Forwarding</p>

Table 6-2. Adding Auxiliary Equipment

If Adding...	Complete these Forms...
Maintenance Alarm, Music-On-Hold, Loudspeaker Paging	Form 2c, System Numbering: Line/Trunk Jacks

Table 6-3. Adding New Extensions

If Adding...	Complete these Forms...
New Extensions	All columns of Form 2a, System Numbering: Extension Jacks Copy of appropriate telephone/operator Forms 4a through 4f, and 5a through 5d Consider revisions to: Group Assigned Features (Forms 7a through 7d) Allowed and Disallowed List assignments (Forms 6e and 6f) Night Service assignments (Forms 9a through 9c) Extension Labels (Form 2a)
Operator console	Consider revisions to: Optional Operator Features (Form 6a) Extension Status assignment (Form 8a)

Upgrading

7



WARNING:

The following procedures are to be used by qualified technicians or service personnel only. Installation or maintenance of this product by anyone other than qualified personnel may damage or impair the product; your limited warranty does not cover such damage. For details, see your limited warranty in [Appendix A](#), "[Customer Support Information](#)."

Hazardous electrical voltages are present inside this product.

This chapter contains information about upgrading the system to Release 7.0. You can perform the following upgrades:

- From Release 1.0 to Release 7.0
- From Release 1.1 to Release 7.0
- From Release 2.0 to Release 7.0
- From Release 2.1 to Release 7.0
- From Release 3.0 to Release 7.0
- From Release 3.1 to Release 7.0
- From Release 4.0 to Release 7.0
- From Release 4.1 to Release 7.0
- From Release 4.2 to Release 7.0
- From Release 5.0 to Release 7.0
- From Release 6.0 to Release 7.0
- From Release 6.1 to Release 7.0

MERLIN II Communications System programming cannot be upgraded to this communications system. Any upgrades from MERLIN II must be considered a new installation to MERLIN LEGEND.

Upgrading to Release 7.0

This section contains an overview of upgrading from Releases 1.0, 1.1, 2.0, 2.1, 3.0, 3.1, 4.0, 4.1, 4.2, 5.0, 6.0, and 6.1 to Release 7.0. Before you begin the upgrade to Release 7.0, you need the following items:

- Any version of DOS SPM or WinSPM to back up system programming
- WinSPM Release 2 or later, which contains SPM Version 7.15 or later to convert and restore system programming information

If SPM is already installed, the `Welcome to SPM` screen that appears when you start SPM identifies the version on both the last line of the console simulation window and in the upper left corner of the screen. If you have Version 7.15, `v7` appears in the upper left corner of the screen and `Version 7.15` appears on the last line of the console simulation window.



NOTE:

The version of SPM packaged with Intuity does not support conversion. The most current version of DOS or UNIX SPM is available for download from the NSAC bulletin board.

- A CKE4 or later processor module if one is not already installed in the system
- An R7.0 Forced Installation PCMCIA Memory Card



NOTES:

- If a new processor module is installed as part of the upgrade procedure, the system software is already installed. Use the R7.0 Forced Installation Memory Card only if you are upgrading a system and the processor module has not been replaced.
- If you are upgrading Releases 1.0/1.1 or 2.0/2.1 to Release 7.0, you need a new CKE4 processor module. Also, you must install a Release 7.0 CKE4 processor module for any earlier system release (1.0 to 6.1) that has a CKE3 or earlier processor module. The processor name appears on the label on the front of the module. If "CKE4" does not appear on the label, you must replace the module.
- If you are using an 016 MLX module, you need a CKE4 or later processor module. The processor name appears on the label on the front of the module. If "CKE4" does not appear on the label, you must replace the module.

Upgrade Procedure

To upgrade to Release 7.0, you must back up, convert, and restore system programming information. Follow these steps:

1. Back up the system programming.
This step creates a file containing system programming information. Any version of SPM may be used to back up system programming.
2. Install DOS SPM or WinSPM.
 - If you are using DOS SPM, you must have Version 7.15 to upgrade the system to Release 7.0. If DOS SPM Version 7.15 is already installed on your system, proceed to Step 3.
 - If you are using WinSPM, you must have Release 2.0 to upgrade the system to Release 7.0. If WinSPM Release 2.0 is already installed on your system, proceed to Step 3.
3. Convert your backup file.
4. Turn off the AC power switches on the control unit power supplies in the following order:
 - a. Basic carrier
 - b. Expansion carrier 1
 - c. Expansion carrier 2
5. If the system already has a CKE4 or later processor module, proceed to [Step 6](#). Otherwise, follow these steps to replace the processor module:
 - a. Unplug the interface cords from the SPM and SMDR printer ports on the processor module.
 - b. Remove the processor module from Slot 0.
 - c. Install the new CKE4 or later processor module in Slot 0.
 - d. Plug the interface cords into the SPM and SMDR printer ports on the processor module.
6. If a new processor module was installed in [Step 5](#), go to [Step 7](#). Otherwise, insert a Release 7.0 Forced Installation Memory Card into the PCMCIA memory card slot on the processor module.



NOTE:

Using the Forced Installation Memory Card causes a frigid start.

7. Turn on the AC power switches on the power supply modules in the control unit in the following order:
 - a. Expansion carrier 2
 - b. Expansion carrier 1
 - c. Basic carrier
8. Restore the system programming.



NOTE:

The system is forced idle and cannot be used during this procedure.

9. Program new features. If you want to use the factory settings for the new Release 7.0 features, skip this step.



NOTE:

When upgrading from a networked Release 6.0 system (not a Release 6.1 system), the non-local dial plan extension ranges must be programmed to suit the customer's configuration.

For more detailed information and procedures (including error conditions and recovery as well as procedures for translation conversion), see *Maintenance and Troubleshooting*, *System Programming and Maintenance*, and *System Programming*.

Release 7.0 Forms

Changes made to the planning forms for Release 7.0 reflect enhancements made for Release 7.0.

[Table 7-1](#) compares the planning forms for each major release.

Table 7-1. Planning Forms

1.0	2.0	3.0	4.0/ 5.0	6.0	6.1	7.0	7.0 Form Title...
N/A	N/A						Employee Communication Survey
1	1	1	1	1	1	1	System Planning
2a	2a	2a	2a	2a	2a	2a	System Numbering: Extension Jacks
2b	2b	2b	2b	2b	2b	2b	System Numbering: Digital Adjuncts
2c	2c	2c	2c	2c	2c	2c	System Numbering: Line/Trunk Jacks
2d	2d	2d	2d	2d	2d	2d	System Numbering: Special Renumbers
2e							(1.0 form, Technician's Run Sheet now included on Form 2c)
3a	3a	3a	3a	3a	3a	3a	Incoming Trunks: Remote Access
3b							(1.0 form, Incoming Trunks — Pools now included on Form 2a)
3c	3b	3b	3b	3b	3b	3b	Incoming Trunks: DS1 Connectivity (100D Module)
3d	3c	3c	3c	3c	3c	3c	Incoming Trunks: Tie
3e	3d	3d	3d	3d	3d	3d	Incoming Trunks: DID
		3e	3e	3e	3e	3e	Automatic Route Selection Worksheet
		3f	3f	3f	3f	3f	Automatic Route Selection Tables
		3g	3g	3g	3g	3g	Automatic Route Selection Default and Special Numbers Tables
		3h	3h	3h	3h	3h	LS-ID Delay
			3i	3i	3i	3i	Incoming Trunks: BRI Options (800 NI-BRI Module)
	4a	4a	4a	4a	4a	4a	Extension Copy: Analog Multiline Telephone Template

Table 7-1. Planning Forms — Continued

1.0	2.0	3.0	4.0/ 5.0	6.0	6.1	7.0	7.0 Form Title...
4a	4b	4b	4b	4b	4b	4b	Analog Multiline Telephone
	4c	4c	4c	4c	4c	4c	Extension Copy: MLX Telephone Template
4b	4d	4d	4d	4d	4d	4d	MLX Telephone
4b	4e	4e	4e	4e	4e	4e	MFM Adjunct: MLX Telephone
4c	4f	4f	4f	4f	4f	4f	Tip/Ring Equipment
						4g	Extension Copy: ETR Telephone Template
						4h	ETR Telephone
						4i	Extension Copy: MLS Telephone Template
						4j	MLS Telephone
5a	5a	5a	5a	5a	5a	5a	Direct-Line Console (DLC): Analog
5b	5b	5b	5b	5b	5b	5b	Direct-Line Console (DLC): Digital
5b	5c	5c	5c	5c	5c	5c	MFM Adjunct: DLC
5c	5d	5d	5d	5d	5d	5d	Queued Call Console (QCC)
6a	6a	6a	6a	6a	6a	6a	Optional Operator Features
		6b	6b	6b	6b	6b	Optional Extension Features
		6c	6c	6c	6c	6c	Principal User of Personal Line
		6d	6d	6d	6d	6d	Message-Waiting Receivers
		6e	6e	6e	6e	6e	Allowed Lists
		6f	6f	6f	6f	6f	Disallowed Lists
		6g	6g	6g	6g	6g	Call Restriction Assignments and Lists
		6h	6h	6h	6h	6h	Authorization Codes
		6i	6i	6i	6i	6i	Pool Dial-Out Code Restrictions
6b	6b						Call Pickup Groups
6c	6c						Group Paging
6d	6d						Group Coverage
6e	6e						Group Calling
6f	6f						System Features

Table 7-1. Planning Forms — Continued

1.0	2.0	3.0	4.0/ 5.0	6.0	6.1	7.0	7.0 Form Title...
6g	6g						Allowed Lists
6h	6h						Disallowed Lists
	6i						Call Restriction Assignments and Lists
7a	7a						Night Service: Group Assignment
		7a	7a	7a	7a	7a	Call Pickup Groups
7b	7b						Night Service: Outward Restriction
		7b	7b	7b	7b	7b	Group Paging
7c	7c						Night Service: Time Set
		7c	7c	7c	7c	7c	Group Coverage
		7d	7d	7d	7d	7d	Group Calling
8a							(1.0 form, Label Form — Trunks, now included on Form 2c)
		8a	8a	8a	8a	8a	System Features
8b							(1.0 form, Label Form — Stations and Calling Groups, now included on Form 2a)
8c	8a						Label Form: Posted Message
8d	8b						System Speed Dial
9a	9a						Automatic Route Selection Worksheet
		9a	9a	9a	9a	9a	Night Service: Group Assignment
9b	9b						Automatic Route Selection Tables
		9b	9b	9b	9b	9b	Night Service: Outward Restriction
9c	9c						Automatic Route Selection Default and Special Numbers Tables
		9c	9c	9c	9c	9c	Night Service: Time Set
		10a	10a	10a	10a	10a	Label Form: Posted Message
		10b	10b	10b	10b	10b	System Speed Dial
					11	11	Service Observing: Group Assignment

7 Upgrading
Release 7.0 Forms

7-8

Customer Support Information



Support Telephone Number

In the USA only, Lucent Technologies provides a toll-tree customer Helpline (1-800-628-2888) 24 hours a day. If you need assistance when installing, programming, or using your system, call the Helpline or your Lucent Technologies representative. Consultation charges may apply.

Outside the USA, if you need assistance when installing, programming, or using your system, contact your Lucent Technologies representative.

Federal Communications Commission (FCC) Electromagnetic Interference Information

This equipment has been tested and found to comply with the limits for a Class A digital device, pursuant to Part 15 of the FCC Rules. These limits are designed to provide reasonable protection against harmful interference when the equipment is operated in a commercial environment. This equipment generates, uses, and can radiate radio frequency energy and, if not installed and used in accordance with the instruction manual, may cause harmful interference to radio communications. Operation of this equipment in a residential area is likely to cause harmful interference, in which case the user will be required to correct the interference at his or her own expense.

Canadian Department of Communications (DOC) Interference Information

This digital apparatus does not exceed the Class A limits for radio noise emissions set out in the radio interference regulations of the Canadian Department of Communications.

Le Présent Appareil Numérique n'émet pas de bruits radioélectriques dépassant les limites applicables aux appareils numériques de la classe A prescrites dans le règlement sur le brouillage radioélectrique édicté par le ministère des Communications du Canada.

FCC Notification and Repair Information

This equipment is registered with the FCC in accordance with Part 68 of its rules. In compliance with those rules, you are advised of the following:

- **Means of Connection.** Connection of this equipment to the telephone network shall be through a standard network interface jack, USOC RJ11C, RJ14C, or RJ21X. Connection to E&M tie trunks requires a USOC RJ2GX. Connection to off-premises extensions requires a USOC RJ11C or RJ14C. Connection to 1.544-Mbps digital facilities must be through a USOC RJ48C or RJ48X. Connection to DID requires a USOC RJ11C, RJ14C, or RJ21X. These USOCs must be ordered from your telephone company. Connection to 56-Kbps or 64-Kbps facilities requires a USOC RJ11C, RJ14C, or RJ21.
- **Party Lines and Coin Telephones.** This equipment may not be used with party lines or coin telephone lines.
- **Notification to the Telephone Companies.** Before connecting this equipment, you or your equipment supplier must notify your local telephone company's business office of the following:
 - The telephone number or numbers you will be using with this equipment.
 - The appropriate registration number and ringer equivalence number (REN), which can be found on the back or bottom of the control unit, as follows:
 - If this equipment is to be used as a Key system, report the number AS593M-72914-KF-E.
 - If the system provides both manual and automatic selection of incoming/outgoing access to the network, report the number AS593M-72682-MF-E.

- If there are no directly terminated trunks, or if the only directly terminated facilities are personal lines, report the number AS5USA-65646-PF-E.
- The REN (Ringer Equivalence Number) for all three systems is 1.5A.
- The facility interface code (FIC) and service order code (SOC): For tie line connection, the FIC is TL31M and the SOC is 9.0F.
 - For connection to off-premises stations, the FIC is OL13C and the SOC is 9.0F.
 - For equipment to be connected to DID facilities, the FIC is 02RV2-T and the SOC is AS.2.
 - For equipment to be connected to 1.544-Mbps digital service, the SOC is 6.0P and the FIC is:
 - 04DU9-BN for D4 framing format with AMI zero code suppression.
 - 04DU9-DN for D4 framing format with bipolar 8 zero code suppression (B8ZS).04DU9-IKN for extended superframe format (ESF) with AMI zero code suppression.
 - 04DU9-ISN with ESF and B8ZS.
 - For equipment to be connected to 56-Kbps or 64-Kbps digital facilities, the FIC is 02B1Q.
- The quantities and USOC numbers of the jacks required.
- For each jack, the sequence in which lines are to be connected, the line types, the FIC, and the REN by position, when applicable.
- **Ringer Equivalence Number (REN).** The REN is used to determine the number of devices that may be connected to the telephone line. Excessive RENs on the line may result in the devices not ringing in response to an incoming call. In most, but not all, areas, the sum of the RENs should not exceed five (5.0). To be certain of the number of devices that may be connected to the line, as determined by the total RENs, contact the local telephone company to determine the maximum REN for the calling area.
- **Disconnection.** You must also notify your local telephone company if and when this equipment is permanently disconnected from the line or lines.

Installation and Operational Procedures

The guides for your system contain information about installation and operational procedures.

- **Repair Instructions.** If you experience trouble because your equipment is malfunctioning, the FCC requires that the equipment not be used and that it be disconnected from the network until the problem has been corrected. Repairs to this equipment can be made only by the manufacturers, their authorized agents, or others who may be authorized by the FCC. In the event repairs are needed on this equipment, contact your authorized Lucent Technologies dealer or, **in the USA only**, contact the National Service Assistance Center (NSAC) at 1-800-628-2888.
- **Rights of the Local Telephone Company.** If this equipment causes harm to the telephone network, the local telephone company may discontinue your service temporarily. If possible, they will notify you in advance. But if advance notice is not practical, you will be notified as soon as possible. You will also be informed of your right to file a complaint with the FCC.
- **Changes at Local Telephone Company.** Your local telephone company may make changes in its facilities, equipment, operations, or procedures that affect the proper functioning of this equipment. If they do, you will be notified in advance to give you an opportunity to maintain uninterrupted telephone service.
- **Hearing Aid Compatibility.** The custom telephone sets for this system are compatible with inductively coupled hearing aids as prescribed by the FCC.
- **Automatic Dialers.** WHEN PROGRAMMING EMERGENCY NUMBERS AND/OR MAKING TEST CALLS TO EMERGENCY NUMBERS:
 - Remain on the line and briefly explain to the dispatcher the reason for the call.
 - Perform such activities in off-peak hours, such as early morning or late evening.
- **Direct Inward Dialing (DID).** This equipment returns answer supervision signals to the Public Switched Telephone Network when:
 - Answered by the called station.
 - Answered by the attendant.
 - Routed to a recorded announcement that can be administered by the customer premises equipment user.
 - Routed to a dial prompt.

This equipment returns answer supervision on all DID calls forwarded back to the Public Switched Telephone Network. Permissible exceptions are when:

- A call is unanswered.
- A busy tone is received.
- A reorder tone is received.

Allowing this equipment to be operated in such a manner as not to provide proper answer supervision signaling is in violation of Part 68 rules.

New Network Area and Exchange Codes. The MERLIN LEGEND Communications System software does not restrict access to any new area codes or exchange codes established by a local telephone company. If the user has established toll restrictions on the system that could restrict access, then the user should check the lists of allowed and disallowed dial codes and modify them as needed.

Equal Access Codes. This equipment is capable of providing users access to interstate providers of operator services through the use of access codes. Modifications of this equipment by call aggregators to block access dialing codes is a violation of the Telephone Operator Consumers Act of 1990.

DOC Notification and Repair Information

NOTICE: The Canadian Department of Communications (DOC) label identifies certified equipment. This certification means that the equipment meets certain protective, operational, and safety requirements of the telecommunications network. The DOC does not guarantee the equipment will operate to the user's satisfaction.

Before installing this equipment, users should ensure that it is permissible to connect it to the facilities of the local telecommunications company. The equipment must also be installed using an acceptable method of connection. In some cases, the company's inside wiring for single-line individual service may be extended by means of a certified connector assembly (telephone extension cord). The customer should be aware that compliance with the above conditions may not prevent degradation of service in some situations.

Repairs to certified equipment should be made by an authorized Canadian maintenance facility designated by the supplier. Any repairs or alterations made by the user to this equipment, or any equipment malfunctions, may give the telecommunications company cause to request the user to disconnect the equipment.

Users should ensure, for their own protection, that the electrical ground connections of the power utility, telephone lines, and internal metallic water pipe system, if present, are connected. This precaution may be particularly important in rural areas.



CAUTION:

Users should not attempt to make such connections themselves, but should contact the appropriate electrical inspection authority or electrician.

To prevent overloading, the Load Number (LN) assigned to each terminal device denotes the percentage of the total load to be connected to a telephone loop used by the device. The termination on a loop may consist of any combination of devices subject only to the requirement that the total of the Load Numbers of all the devices does not exceed 100.

DOC Certification No.: 230 4095A

CSA Certification No.: LR 56260

Load No.: 6

Renseignements sur la Notification du Ministère des Communications du Canada et la Réparation

AVIS: L'étiquette du ministère des Communications du Canada identifie le matériel homologué. Cette étiquette certifie que le matériel est conforme à certaines normes de protection, d'exploitation et de sécurité des réseaux de télécommunications. Le Ministère n'assure toutefois pas que le matériel fonctionnera à la satisfaction de l'utilisateur.

Avant d'installer ce matériel, l'utilisateur doit s'assurer qu'il est permis de le raccorder aux installations de l'entreprise locale de télécommunication. Le matériel doit également être installé en suivant une méthode acceptée de raccordement. Dans certains cas, les fils intérieurs de l'entreprise utilisés pour un service individuel à ligne unique peuvent être prolongés au moyen d'un dispositif homologué de raccordement (cordon prolongateur téléphonique interne). L'abonné ne doit pas oublier qu'il est possible que la conformité aux conditions énoncées ci-dessus n'empêchent pas la dégradation du service dans certaines situations. Actuellement, les entreprises de télécommunication ne permettent pas que l'on raccorde leur matériel à des jacks d'abonné, sauf dans les cas précis prévus par les tarifs particuliers de ces entreprises.

Les réparations de matériel homologué doivent être effectuées par un centre d'entretien canadien autorisé désigné par le fournisseur. La compagnie de télécommunications peut demander à l'utilisateur de débrancher un appareil à la suite de réparations ou de modifications effectuées par l'utilisateur ou à cause de mauvais fonctionnement.

Pour sa propre protection, l'utilisateur doit s'assurer que tous les fils de mise à la terre de la source d'énergie électrique, des lignes téléphoniques et des canalisations d'eau métalliques, s'il y en a, sont raccordés ensemble. Cette précaution est particulièrement importante dans les régions rurales.

AVERTISSEMENT: L'utilisateur ne doit pas tenter de faire ces raccordements lui-même; il doit avoir recours à un service d'inspection des installations électriques, ou à un électricien, selon le cas.

L'indice de charge (IC) assigné à chaque dispositif terminal indique, pour éviter toute surcharge, le pourcentage de la charge totale qui peut être raccordée à un circuit téléphonique bouclé utilisé par ce dispositif. La terminaison du circuit bouclé peut être constituée de n'importe quelle combinaison de dispositifs, pourvu que la somme des indices de charge de l'ensemble des dispositifs ne dépasse pas 100.

No d'homologation: 230 4095A

No de certification: CSA LR 56260

L'indice de charge: 6

**MERLIN LEGEND D.O.C.
Location Label Placement**

**Ministère des Communications
du Canada emplacement de
l'étiquette**

Lucent  **MERLIN LEGEND**

Model 511A Control Unit

UL LISTED 538E  **TELEPHONE EQUIPMENT**  LR 56260

MADE IN U.S.A.

This device complies with Part 15 of the FCC Rules. Operation is subject to the following two conditions: (1) this device may not cause harmful interference, and (2) this device must accept any interference received, including interference that may cause undesired operation.

Complies with Part 68, FCC Rules. See the System Reference Manual for proper FCC Classification.
FCC Reg. Nos. MF: A5933M-7282-MF-E
KF: A5933M-72914-KF-E
PF: A5933M-65946-PF-E
REN: 1.5A

CANADA

DR ID

WARNING: If equipment is used for out-of-building applications, approved secondary protectors are required. See Installation Manual.

AVERTISSEMENT: Si l'équipement est utilisé pour des applications extérieures, l'installation d'un protecteur secondaire est requise. Voir le manuel d'installation.

Use only Lucent Technologies manufactured MERLIN LEGEND circuit modules, carrier assemblies, and power units, as specified in the Installation Manual, in this product. There are no user serviceable parts inside. Contact your authorized agent for service and repair.

This digital apparatus does not exceed the Class A limits for radio noise emissions set out in the radio interference regulations of the Canadian Department of Communications.

Le présent appareil numérique n'émet pas de bruits radioélectriques dépassant les limites applicables aux appareils numériques de la classe A prescrites dans le Règlement sur le brouillage radioélectrique édicté par le ministère des Communications du Canada.

Security of Your System: Preventing Toll Fraud

As a customer of a new telephone system, you should be aware that there is an increasing problem of telephone toll fraud. Telephone toll fraud can occur in many forms, despite the numerous efforts of telephone companies and telephone equipment manufacturers to control it. Some individuals use electronic devices to prevent or falsify records of these calls. Others charge calls to someone else's number by illegally using lost or stolen calling cards, billing innocent parties, clipping on to someone else's line, and breaking into someone else's telephone equipment physically or electronically. In certain instances, unauthorized individuals make connections to the telephone network through the use of the Remote Access features of your system.

The Remote Access features of your system, if you choose to use them, permit off-premises callers to access the system from a remote telephone by using a telephone number with or without a barrier code. The system returns an acknowledgment, signaling the user to key in his or her barrier code, which is selected and administered by the system manager. After the barrier code is accepted, the system returns dial tone to the user. In Release 3.1 and later systems, barrier codes are, by default, restricted from making outside calls. In prior releases, if you do not program specific outward calling restrictions, the user is able to place any call normally dialed from a telephone associated with the system. Such an off-premises network call is originated at, and will be billed from, the system location.

The Remote Access feature, as designed, helps the customer, through proper administration, to minimize the ability of unauthorized persons to gain access to the network. Most commonly, telephone numbers and codes are compromised when overheard in a public location, through theft of a wallet or purse containing access information, or through carelessness (for example, writing codes on a piece of paper and improperly discarding it). Additionally, hackers may use a computer to dial an access code and then publish the information to other hackers. Enormous charges can be run up quickly. It is the customer's responsibility to take the appropriate steps to properly implement the features, evaluate and administer the various restriction levels, protect access codes, and distribute access codes only to individuals who have been fully advised of the sensitive nature of the access information.

Common carriers are required by law to collect their tariffed charges. While these charges are fraudulent charges made by persons with criminal intent, applicable tariffs state that the customer of record is responsible for payment of all long-distance or other network charges. Lucent Technologies cannot be responsible for such charges and will not make any allowance or give any credit for charges that result from unauthorized access.

To minimize the risk of unauthorized access to your communications system:

- Use an unpublished Remote Access number.
- Assign access codes randomly to users on a need-to-have basis, keeping a log of *all* authorized users and assigning one code to each person.
- Use random-sequence access codes, which are less likely to be broken.
- Use the longest-length access codes the system will allow.
- Deactivate all unassigned codes promptly.
- Ensure that Remote Access users are aware of their responsibility to keep the telephone number and any access codes secure.
- When possible, restrict the off-network capability of off-premises callers, using calling restrictions, Facility Restriction Levels (Hybrid/PBX mode only), and Disallowed List capabilities. In Release 3.1 and later systems, a prepared Disallowed List (number 7) is provided and is designed to prevent the types of calls that toll-fraud abusers often make.
- When possible, block out-of-hours calling.
- Frequently monitor system call detail reports for quicker detection of any unauthorized or abnormal calling patterns.
- Limit Remote Call Forwarding to persons on a need-to-have basis.
- Change access codes every 90 days.
- Use the longest-length barrier codes possible, following the guidelines for passwords. (See [“Choosing Passwords” on page A-19.](#))

Toll Fraud Prevention

Toll fraud is the unauthorized use of your telecommunications system by third parties to make long-distance telephone calls. Under the law, you, the customer, are responsible for paying part or all of those unauthorized calls. Thus, the following information is of critical importance.

Unauthorized persons concentrate their activities in two areas with the MERLIN LEGEND Communications System:

- They try to transfer out of the MERLIN LEGEND Communications System to gain access to an outgoing trunk and make long-distance calls.
- They try to locate unused or unprotected mailboxes and use them as drop-off points for their own messages.

The following is a discussion of how toll fraud is often perpetrated and ways to prevent unauthorized access that can lead to toll fraud.

Physical Security, Social Engineering, and General Security Measures

Criminals called hackers may attempt to gain unauthorized access to your communications system and voice messaging system in order to use the system features. Hackers often attempt to trick employees into providing them with access to a network facility (line/trunk) or a network operator. This is referred to as social engineering. Hackers may pose as telephone company employees or employees of Lucent Technologies or your authorized dealer. Hackers will go through a company's trash to find directories, dialing instructions, and other information that will enable them to break into the system. The more knowledgeable they appear to be about the employee names, departments, telephone numbers, and the internal procedures of your company, the more likely it is that they will be able to trick an employee into helping them.

Preventive Measures

Take the following preventive measures to limit the risk of unauthorized access by hackers:

- Provide good physical security for the room containing your telecommunications equipment and the room with administrative tools, records, and system manager information. These areas should be locked when not attended.
- Provide a secure trash disposal for all sensitive information, including telephone directories, call accounting records, or anything that may supply information about your communications system. This trash should be shredded.
- Educate employees that hackers may try to trick them into providing them with dial tone or dialing a number for them. All reports of trouble, requests for moving extensions, or any other administrative details associated with the MERLIN LEGEND Communications System should be handled by one person (the system manager) or within a specified department. Anyone claiming to be a telephone company representative should be referred to this person or department.
- No one outside of Lucent Technologies needs to use the MERLIN LEGEND Communications System to test facilities (lines/trunks). If a caller claims to be a Lucent Technologies employee, the system manager should ask for a telephone number where the caller can be reached. The system manager should be able to recognize the number as a Lucent Technologies telephone number. *Before connecting the caller to the administrative port of the MERLIN LEGEND Communications System, the system manager should feel comfortable that a good reason to do so exists.* In any event, it is not advisable to give anyone access to network facilities or operators, or to dial a number at the request of the caller.

- Any time a call appears to be suspicious, call the Lucent Technologies BCS Fraud Intervention Center at 1-800-628-2888 (fraud intervention for System 25, PARTNER® and MERLIN Systems).
- Customers should also take advantage of Lucent Technologies monitoring services and devices, such as the NetPROTECTSM family of fraud-detection services, CAS with HackerTracker®, and CAT Terminal with Watchdog. Call 1-800-638-7233 to get more information on these Lucent Technologies fraud detection services and products.

Security Risks Associated with Transferring through Voice Messaging Systems

Toll fraud hackers try to dial into a voice mailbox and then execute a transfer by dialing *T. The hacker then dials an access code (either 9 for Automatic Route Selection or a pooled facility code), followed by the appropriate digit string to either direct dial or access a network operator to complete the call.



NOTE:

In Release 3.1 and later systems, all extensions are initially, and by default, restricted from dial access to pools. In order for an extension to use a pool to access an outside line/trunk, this restriction must be removed.

Preventive Measures

Take the following preventive measures to limit the risk of unauthorized transfers by hackers:

- Outward restrict all MERLIN LEGEND Communications System voice mail port extension numbers. This denies access to facilities (lines/trunks). In Release 3.1 and later systems, voice mail ports are, by default, outward restricted.
- As an additional security step, network dialing for all extensions, including voice mail port extensions, should be processed through ARS using dial access code 9.



SECURITY ALERT:

*The MERLIN LEGEND Communications System ships with ARS activated with all extensions set to Facility Restriction Level 3, allowing all international calling. **To prevent toll fraud, ARS Facility Restriction Levels (FRLs) should be established using:***

- FRL 0 for restriction to internal dialing only.
- FRL 2 for restriction to local network calling only.
- FRL 3 for restriction to domestic long-distance (excluding area code 809 for the Dominican Republic as this is part of the North American Numbering Plan, unless 809 is required).
- FRL 4 for international calling.



WARNING:

In Release 3.1 and later systems, default local and default toll tables are factory-assigned an FRL of 2. This simplifies the task of restricting extensions: the FRL for an extension merely needs to be changed from the default of 3.



WARNING:

Each extension should be assigned the appropriate FRL to match its calling requirements. All voice mail port extensions not used for Outcalling should be assigned to FRL 0 (the default setting in Release 3.1 and later).

- Deny access to pooled facility codes by removing pool dial-out codes 70, 890-899, or any others on your system.
- Create a Disallowed List or use the pre-prepared Disallowed List number 7 (Release 3.1 and later systems only) to disallow dialing 0, 11, 10, 1700, 1809, 1900, and 976 or 1 (wildcard) 976. In Release 3.1 and later systems, Disallowed List number 7 does not include 800, 1800, 411, and 1411, but Lucent Technologies recommends that you add them.



NOTE:

Assign all voice mail port extensions to this Disallowed List. Lucent Technologies recommends assigning Disallowed List number 7. This is an added layer of security, in case outward restriction is inadvertently removed. (In Release 3.1 and later systems, voice messaging ports are assigned, by default, to Disallowed List number 7.)

If Outcalling is required by voice messaging system extensions:

- Program an ARS Facility Restriction Level (FRL) of 2 on voice mail port extensions used for Outcalling.
- If 800 and 411 numbers are used, remove 1800, 800, 411, and 1411 from Disallowed List number 7.
- If Outcalling is allowed to long-distance numbers, build an Allowed List for the voice mail port extensions used for Outcalling. This list should contain the area code and the first three digits of the local exchange telephone numbers to be allowed.

Additional general security for voice messaging systems:

- Use a secure password for the General Mailboxes.
- The default administration mailbox, 9997, must be reassigned to the system manager's mailbox/extension number and securely password protected.
- All voice messaging system users must use secure passwords known only to the user.

Security Risks Associated with the Automated Attendant Feature of Voice Messaging Systems

Two areas of toll fraud risk associated with the Automated Attendant feature of voice messaging systems are:

- Pooled facility (line/trunk) access codes are translated to a menu prompt to allow Remote Access. If a hacker finds this prompt, the hacker has immediate access. (In Release 3.1 and later systems, dial access to pools is initially factory-set to restrict all extensions: to allow pool access, this restriction must be removed by the system manager.)
- If the Automated Attendant prompts callers to use Remote Call Forwarding (RCF) to reach an outside telephone number, the system may be susceptible to toll fraud. An example of this application is a menu or submenu that says, "To reach our answering service, select prompt number 5," and transfers a caller to an external telephone number.

Remote Call Forwarding can be used securely only when the central office provides "reliable disconnect" (sometimes referred to as forward disconnect or disconnect supervision), which guarantees that the central office does not return a dial tone after the called party hangs up. In most cases, the central office facility is a loop-start line/trunk which does not provide reliable disconnect. When loop-start lines/trunks are used, if the calling party stays on the line, the central office does return a dial tone at the conclusion of the call, enabling the caller to place another call as if it were being placed from your company. Ground-start trunks provide reliable disconnect and should be used whenever possible.

Preventive Measures

Take the following preventive measures to limit the risk of unauthorized use of the Automated Attendant feature by hackers:

- *Do not* use Automated Attendant prompts for Automatic Route Selection (ARS) codes or Pooled Facility codes.
- Assign all unused Automated Attendant selector codes to zero, so that attempts to dial these are routed to the system attendant.
- If Remote Call Forwarding (RCF) is required, MERLIN LEGEND Communications System owners should coordinate with their Lucent Technologies Account Team or authorized dealer to verify the type of central office facility used for RCF. If it is a ground-start line/trunk, or if it is a loop-start line/trunk and central office reliable disconnect can be ensured, then nothing else needs to be done.



NOTE:

In most cases, these are loop-start lines/trunks without reliable disconnect. The local telephone company must be involved in order to change the facilities used for RCF to ground-start line/trunks. Usually, a charge applies for this change. Also, hardware and software changes may be necessary in

the MERLIN LEGEND Communications System. The MERLIN Mail MERLIN and MERLIN LEGEND Mail Automated Attendant feature merely accesses the RCF feature in the MERLIN LEGEND Communications System. Without these changes being made, this feature is highly susceptible to toll fraud. These same preventive measures must be taken if the RCF feature is active for MERLIN LEGEND Communications System extensions, whether or not it is accessed by an Automated Attendant menu.

Security Risks Associated with the Remote Access Feature

Remote Access allows the MERLIN LEGEND Communications System owner to access the system from a remote telephone and make an outgoing call or perform system administration using the network facilities (lines/trunks) connected to the MERLIN LEGEND Communications System. Hackers, scanning the public switched network by randomly dialing numbers with war dialers (a device that randomly dials telephone numbers, including 800 numbers, until a modem or dial tone is obtained), can find this feature, which will return a dial tone to them. They can even employ war dialers to attempt to discover barrier codes.

Preventive Measures

Take the following preventive measures to limit the risk of unauthorized use of the MERLIN LEGEND Communications System Remote Access feature:

- The Remote Access feature can be abused by criminal toll fraud hackers if it is not properly administered. Therefore, this feature should not be used unless there is a strong business need.
- It is strongly recommended that customers invest in security adjuncts, which typically use one-time passcode algorithms. These security adjuncts discourage hackers. Since a secure use of the Remote Access feature generally offers savings over credit-card calling, the break-even period can make the investment in security adjuncts worthwhile.
- If a customer chooses to use the Remote Access feature without a security adjunct, then multiple barrier codes should be employed, with one per user, if the system permits. The MERLIN LEGEND Communications System permits a maximum of 16 barrier codes.
- The maximum length should be used for each barrier code, and should be changed periodically. Barrier codes, like passwords, should consist of a random, hard-to-guess sequence of digits. While MERLIN LEGEND Communications System Release 3.0 permits a barrier code of up to 11 digits, systems prior to Release 3.0 permit barrier codes of up to only four digits.

If Remote Access is used, an upgrade to MERLIN LEGEND Communications System Release 3.0 is encouraged to take advantage of the longer barrier code.

Other Security Hints

Make sure that the Automated Attendant selector codes do not permit outside line selection.

Multiple layers of security are always recommended to keep your system secure.

A number of measures and guidelines that can help you ensure the security of your communications system and voice messaging system follows:

Educating Users

Everyone in your company who uses the telephone system is responsible for system security. Users and attendants/operators need to be aware of how to recognize and react to potential hacker activity. Informed people are more likely to cooperate with security measures that often make the system less flexible and more difficult to use.

- Never program passwords or authorization codes onto Auto Dial buttons. Display telephones reveal the programmed numbers and internal abusers can use the Auto Dial buttons to originate unauthorized calls.
- Discourage the practice of writing down barrier codes or passwords. If a barrier code or password needs to be written down, keep it in a secure place and never discard it while it is active.
- Instruct operators and attendants to inform tell their system manager whenever they answer a series of calls where there is silence on the other end or the caller hangs up.
- Advise users who are assigned voice mailboxes to frequently change personal passwords and not to choose obvious passwords.
- Ensure that the system manager advises users with special telephone privileges (such as Remote Access, Outcalling, and Remote Call Forwarding) of the potential risks and responsibilities.
- Be suspicious of any caller who claims to be with the telephone company and wants to check an outside line. Ask for a callback number, hang up, and confirm the caller's identity.
- Never distribute the office telephone directory to anyone outside the company; be careful when discarding it (shred the directory).
- Never accept collect telephone calls.
- Never discuss your telephone system's numbering plan with anyone outside the company.

Educating Operators

Operators or attendants need to be especially aware of how to recognize and react to potential hacker activity. To defend against toll fraud, operators should follow the guidelines below:

- Establish procedures to counter *social engineering*. Social engineering is a con game that hackers frequently use to obtain information that may help them gain access to your communications system or voice messaging system.
- When callers ask for assistance in placing outside or long-distance calls, ask for a callback extension.
- Verify the source. Ask callers claiming to be maintenance or service personnel for a callback number. Never transfer to *10 without this verification. Never transfer to extension 900.
- Remove the headset and/or handset when the console is not in use.

Detecting Toll Fraud

To detect toll fraud, users and operators should look for the following:

- Lost voice mail messages, mailbox lockout, or altered greetings
- Inability to log into voice mail
- Inability to get an outside line
- Foreign language callers
- Frequent hang-ups
- Touch-tone sounds
- Caller or employee complaints that the lines are busy
- Increases in internal requests for assistance in making outbound calls (particularly international calls or requests for dial tone)
- Outsiders trying to obtain sensitive information
- Callers claiming to be the "telephone" company
- Sudden increase in wrong numbers

Establishing a Policy

As a safeguard against toll fraud, follow these guidelines for your MERLIN LEGEND Communications System and voice messaging system:

- Change passwords frequently (at least quarterly). Changing passwords routinely on a specific date (such as the first of the month) helps users to remember to do so.
- Always use the longest-length password allowed.
- Establish well-controlled procedures for resetting passwords.
- Limit the number of invalid attempts to access a voice mailbox to five or less.
- Monitor access to the MERLIN LEGEND Communications System dial-up maintenance port. Change the access password regularly and issue it only to authorized personnel. Disconnect the maintenance port when not in use. (This however, eliminates Lucent Technologies' 24-hour maintenance surveillance capability and may result in additional maintenance costs.)
- Create a communications system management policy concerning employee turnover and include these suggestions:
 - Delete all unused voice mailboxes in the voice mail system.
 - If a terminated employee had Remote Access calling privileges and a personal authorization code, remove the authorization code immediately.
 - If barrier codes and/or authorization codes were shared by the terminated employee, these should be changed immediately.
- Regularly back up your MERLIN LEGEND Communications System files to ensure a timely recovery should it be required. Schedule regular, off-site backups.
- Keep the Remote Maintenance Device turned off when not in use by Lucent Technologies or your authorized dealer.
- Limit transfers to registered subscribers only.
- Use the Security Violations Notification options (Mailbox Lock or Warning Message) to alert you of any mailbox break-in attempts. Investigate all incidents.
- Review security policies and procedures and keep them up to date.

Choosing Passwords

Passwords should be the maximum length allowed by the system. Passwords should be hard to guess and should not contain:

- All the same numbers (for example, 1111, 666666).
- Sequential characters (for example, 123456).
- Numbers that can be associated with you or your business, such as your name, birthday, business name, business address, telephone number, or social security number.
- Words and commonly used names.

Passwords should be changed regularly—at least on a quarterly basis. Recycling old passwords is not recommended. Never program passwords (or authorization codes or barrier codes) onto a speed dial button.

Physical Security

You should always limit access to the system console (or attendant console) and supporting documentation. The following are some recommendations:

- Keep the system console and supporting documentation in an office that is secured with a changeable combination lock. Provide the combination only to those individuals having a real need to enter the office.
- Keep telephone wiring closets and equipment rooms locked.
- Keep telephone logs and printed reports in locations that only authorized personnel can enter.
- Design distributed reports so they do not reveal password or trunk access code information.
- Keep the voice messaging system Remote Maintenance Device turned off.

Limiting Outcalling

When Outcalling is used to contact subscribers who are off-site, use the MERLIN LEGEND Communications System Allowed Lists and Disallowed Lists or Automatic Route Selection features to minimize toll fraud.

If the Outcalling feature will not be used, outward restrict all voice messaging system ports. If Outcalling will be used, ports not used for Outcalling should be Outward Restricted (for MERLIN Mail Voice Messaging Systems, port 2 on a 2-port system, port 4 on a 4-port system, ports 5 and 6 on a 6-port system; for MERLIN LEGEND Mail Voice Messaging Systems, port 7 of the system's module). Use Outward Restriction, Toll Restrictions, Allowed Lists, Disallowed Lists and Facility Restrictions Levels, as appropriate, to minimize the possibility of toll fraud.

Limited Warranty and Limitation of Liability

Lucent Technologies warrants to you, the customer, that your MERLIN LEGEND Communications System will be in good working order on the date Lucent Technologies or its authorized reseller delivers or installs the system, whichever is later ("Warranty Date"). If you notify Lucent Technologies or its authorized reseller within one year of the Warranty Date that your system is not in good working order, Lucent Technologies will, without charge to you, repair or replace, at its option, the system components that are not in good working order. Repair or replacement parts may be new or refurbished and will be provided on an exchange basis. If Lucent Technologies determines that your system cannot be repaired or replaced, Lucent Technologies will remove the system and, at your option, refund the purchase price of your system or apply the purchase price towards the purchase of another Lucent Technologies system.

If you purchased your system directly from Lucent Technologies, Lucent Technologies will perform warranty repair in accordance with the terms and conditions of the specific type of Lucent Technologies maintenance coverage you selected. If you purchased your system from a Lucent Technologies-authorized reseller, contact your reseller for the details of the maintenance plan applicable to your system.

This Lucent Technologies limited warranty covers damage to the system caused by power surges, including power surges due to lightning.

The following will not be deemed to impair the good working order of the system, and Lucent Technologies will not be responsible under the limited warranty for damages resulting from:

- Failure to follow Lucent Technologies' installation, operation, or maintenance instructions.
- Unauthorized system modification, movement, or alteration.
- Unauthorized use of common carrier communications services accessed through the system.
- Abuse, misuse, or negligent acts or omissions of the customer and persons under the customer's control.
- Acts of third parties and acts of God.

LUCENT TECHNOLOGIES' OBLIGATION TO REPAIR, REPLACE, OR REFUND AS SET FORTH ABOVE IS YOUR EXCLUSIVE REMEDY.

EXCEPT AS SPECIFICALLY SET FORTH ABOVE, LUCENT TECHNOLOGIES, ITS AFFILIATES, SUPPLIERS, AND AUTHORIZED RESELLERS MAKE NO WARRANTIES, EXPRESS OR IMPLIED, AND SPECIFICALLY DISCLAIM ANY WARRANTIES OF MERCHANTABILITY OR FITNESS FOR A PARTICULAR PURPOSE.

Limitation of Liability

Except as provided below, the liability of Lucent Technologies and its affiliates and suppliers for any claims, losses, damages, or expenses from any cause whatsoever (including acts or omissions of third parties), regardless of the form of action, whether in contract, tort, or otherwise, shall not exceed the lesser of: (1) the direct damages proven; or (2) the repair cost, replacement cost, license fee, annual rental charge, or purchase price, as the case may be, of the equipment that gives rise to the claim. Except as provided below, Lucent Technologies and its affiliates and suppliers shall not be liable for any incidental, special, reliance, consequential, or indirect loss or damage incurred in connection with the equipment. As used in this paragraph, consequential damages include, but are not limited to, the following: lost profits, lost revenues, and losses arising out of unauthorized use (or charges for such use) of common carrier telecommunications services or facilities accessed through or connected to the equipment. For personal injury caused by Lucent Technologies's negligence, Lucent Technologies's liability shall be limited to proven damages to person. **No action or proceeding against Lucent Technologies or its affiliates or suppliers may be commenced more than twenty-four (24) months after the cause of action accrues.** THIS PARAGRAPH SHALL SURVIVE FAILURE OF AN EXCLUSIVE REMEDY.

Remote Administration and Maintenance

The Remote Administration and Maintenance feature of your telecommunications system, if you choose to use it, permits users to change the system features and capabilities from a remote location.

The Remote Administration and Maintenance feature, through proper administration, can help you reduce the risk of unauthorized persons gaining access to the network. However, telephone numbers and access codes can be compromised when overheard in a public location, or lost through theft of a wallet or purse containing access information or through carelessness (for example, writing codes on a piece of paper and improperly discarding them). Additionally, hackers may use a computer to dial an access code and then publish the information to other hackers. Substantial charges can accumulate quickly. It is your responsibility to take appropriate steps to implement the features properly, evaluate and administer the various restriction levels, and protect and carefully distribute access codes.

Under applicable tariffs, you will be responsible for payment of toll charges. Lucent Technologies cannot be responsible for such charges and will not make any allowance or give any credit resulting from unauthorized access.

To reduce the risk of unauthorized access through Remote Administration and Maintenance, please observe the following procedures:

- The System Administration and Maintenance capability of a Hybrid/PBX or Key system is protected by a password.
 - Change the default password immediately.
 - Continue to change the password regularly.
 - Give the password only to people who need it and impress upon them the need to keep it secret.
 - If anyone who knows the password leaves the company, change the password immediately.
- If you have a special telephone line connected to your Hybrid/PBX or Key system for Remote Administration and Maintenance, you should do one of the following:
 - Unplug the line when it is not being used.
 - Install a switch in the line to turn it off when it is not being used.
 - Keep the Remote Administration and Maintenance telephone number secret. Give it only to people who need to know it, and impress upon them the need to keep it a secret. Do not write the telephone number on the Hybrid/PBX or Key system, the connecting equipment, or anywhere else in the system room.

If your Remote Administration and Maintenance feature requires that someone in your office transfer the caller to the Remote Administration and Maintenance extension, you should impress upon your employees the importance of transferring only authorized individuals to that extension.

System Forms

B

This appendix contains one copy of each system planning form. The forms are in numerical order and organized according to planning purpose, as shown in [Table B-1](#). You should make copies of these forms and use the copies, keeping the originals for future use. Planning forms for data communications are contained in [Appendix C](#). The T1/PRI Planner is contained in [Appendix D](#). The NI-1 BRI Planner is contained in [Appendix G](#). The Network Engineering forms are contained in [Appendix I](#).

Table B-1. System Forms

Used for Planning...	Form No.	Form Title
Features and Calling Privileges	N/A	Employee Communication Survey
Control Unit Assembly and Operating Conditions	1	System Planning
System Component Numbering	2a	System Numbering: Extension Jacks
	2b	System Numbering: Digital Adjuncts
	2c	System Numbering: Line/Trunk Jacks
	2d	System Numbering: Special Renumbers

Table B-1. System Forms — Continued

Used for Planning...	Form No.	Form Title
Incoming Line/Trunk Connections	3a	Incoming Trunks: Remote Access
	3b	Incoming Trunks: DS1 Connectivity (100D Module)
	3c	Incoming Trunks: Tie
	3d	Incoming Trunks: DID
	3e	Automatic Route Selection Worksheet
	3f	Automatic Route Selection Tables
	3g	Automatic Route Selection Default and Special Numbers Tables
	3h	LS-ID Delay
	3i	Incoming Trunks: BRI Options
	4a	Extension Copy: Analog Multiline Telephone Template
	4b	Analog Multiline Telephone
	4c	Extension Copy: MLX Telephone Template
	4d	MLX Telephone
	4e	MFM Adjunct: MLX Telephone
	4f	Tip/Ring Equipment
	4g	Extension Copy: ETR Telephone Template
	4h	ETR Telephone
	4i	Extension Copy: MLS Telephone Template
	4j	MLS Telephone
	Features for Operators	5a
5b		Direct-Line Console (DLC): Digital
5c		MFM Adjunct: DLC
5d		Queued Call Console (QCC)
	6a	Optional Operator Features

Table B-1. System Forms — Continued

Used for Planning...	Form No.	Form Title
Features for User	6b	Optional Extension Features
Groups	6c	Principal User of Personal Line
Features for	6d	Message-Waiting Receivers
Systemwide Use	6e	Allowed Lists
	6f	Disallowed Lists
	6g	Call Restriction Assignments and Lists
	6h	Authorization Codes
	6i	Pool Dial-Out Code Restrictions
	7a	Call Pickup Groups
	7b	Group Paging
	7c	Group Coverage
	7d	Group Calling
	8a	System Features
	9a	Night Service: Group Assignment
	9b	Night Service: Outward Restriction
	9c	Night Service: Time Set
	10a	Label Form: Posted Message
	10b	System Speed Dial
	11	Service Observing: Group Assignment

MERLIN LEGEND® Communications System Release 7.0 Employee Communication Survey

Name _____ Room _____ Extension _____

Name of work group (Sales, Customer Service, etc.) _____

Please answer each question below.

1. Do you regularly use any of the following outside lines? (Check any that apply)

- WATS
- FX (foreign exchange)
- Tie
- None of the above or don't know

2. Are your phone calls covered when you're away from your desk?

- No
- Yes By whom? _____

3. Do you want your phone number to appear on another person's phone for screening, or covering calls, or for any other reasons?

- No
- Yes Please list these people:

4. Do you cover phone calls for co-workers when they are away from their desks?

- No
- Yes For whom? _____

Which of those people should have a button on your phone used exclusively for his or her calls?

When you are unable to cover calls, it is done by _____

MERLIN LEGEND® Communications System Release 7.0

Employee Communication Survey

5. Is there a group of people with whom you share responsibilities such that it would be convenient if you could answer each other's calls?

No

Yes With whom? _____

6. Would you say your phone use is

Heavy

Average

Light

Do you need to handle more than two calls at time?

If yes, how many? _____

7. Do you have a data terminal or personal computer at your workstation?

No Do you expect to get one within the next year?

No

Yes

8. Do you use account codes for charge-back of calls?

No

Yes Please list all the codes you use (attach another sheet if necessary):

9. Are there numbers that you and other people in your organization dial over and over every day?

No

Yes Please list these numbers:

10. Do you want to be able to pick up other people's calls when you hear their phones ring?

No

Yes Please list these people:

MERLIN LEGEND® Communications System Release 7.0
Employee Communication Survey

11. Do you need to view incoming caller information?

No

Yes For what purpose? _____

MERLIN LEGEND® Communications System Release 7.0
Employee Communication Survey

Line/Trunk Capacity*

System Planning

Module Type	Number of Modules	Trunks Supported by Module	Total Trunks by Module Type
400 LS/TTR [†]	x	4	
800	x	8	
408	x	4	
400 GS/LS/TTR	x	4	
800 GS/LS	x	8	
408 GS/LS	x	4	
408 GS/LS-MLX	x	4	
408 GS/LS-ID-MLX	x	4	
412 LS/ETR	x	4	
400EM	x	4	
800 DID [†]	x	8	
100D	x	24	
800 GS/LS-ID	x	8	
800 NI-BRI ^{**}	x	16	
System Totals			

Extension Capacity*

Module Type	Number of Modules	Physical Jacks per Module	Physical Jacks by Module Type	Extensions Assigned	Total Extensions Assigned	
008 MLX	x	8	x	2		
008 ATL	x	8	x	1		
408 [†]	x	8	x	1		
408 GS/LS	x	8	x	1		
408 GS/LS-MLX	x	8	x	2		
408 GS/LS-ID-MLX	x	8	x	2		
412 LS-ID-ETR	x	12	x	1		
012	x	12	x	1		
016 (T/R)	x	16	x	1		
016 MLX	x	16	x	1		
016 ETR	x	16	x	1		
008 OPT	x	8	+ (___x4) [§]			
MERLIN LEGEND MAIL	N /A	x	7	N /A	x	12 ^{††}
System Totals						

* System capacity for Personal Directories is decreased by one whenever an MLX-20L telephone is connected to an MLX port.

† Hybrid/PBX mode only.

‡ The 100D module has one physical jack that supports 24 trunks.

§ The 008 OPT module is assigned 12 extension numbers although there are only 8 physical extension jacks.

¶ Although this MERLIN II module is supported, the 400 GS/LS/TTR, the 408 GS/LS, and the 408 GS/LS-MLX are the recommended modules.

** The 800 NI-BRI module has 8 physical jacks that support 16 trunks. Up to five 800 NI-BRI modules (or any combination of LINE/TRUNK modules up to the system maximum of 80 trunks) may be placed in the system. However, due to limitations in the 391A, 391A1, and 391A2 power supplies, the number of 800 NI-BRI modules plus 100D modules cannot exceed 3 per carrier.

†† The MERLIN LEGEND Mail module has 7 dedicated internal ports, but assigns 12 total extensions.

System Planning

Control Unit Diagram

UnitLoadTotal _____	UnitLoadTotal _____	UnitLoadTotal _____
Auxiliary Power Required	Auxiliary Power Required	Auxiliary Power Required
<input type="checkbox"/> Yes	<input type="checkbox"/> Yes	<input type="checkbox"/> Yes
<input type="checkbox"/> No	<input type="checkbox"/> No	<input type="checkbox"/> No

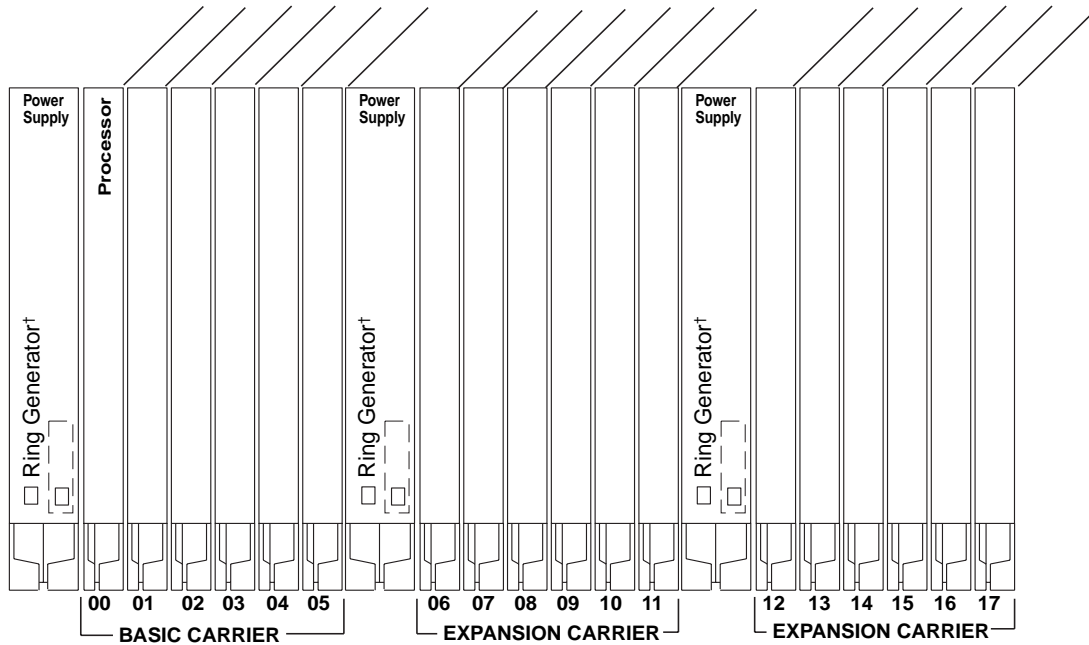

System Operating Conditions

Programming Equipment

- System Programming Console
Logical ID _____ Ext. No. _____
- PC with SPM software
- PCMCIA Memory Card

System Mode

- Key ♦
- Hybrid/PBX*
- Behind Switch
Host Dial Codes:
 - Transfer _____
 - Conference _____
 - Drop _____
- Permanent Key

Language Selection

- System:
- English ♦ French Spanish
- SMDR:
- English ♦ French Spanish
- Printer:
- English ♦ French Spanish

Automatic Maintenance Busy

- Enable
- Disable ♦

Set System Date

- Yes

Backup

- Automatic
Weekly at _____
Daily at _____
- Manual

System Consoles

- QCC (s)

- DLC (s)

- _____
- _____

Second Dial Tone Timer

_____ (0♦ - 5000 ms)

♦ Factory Setting for system software

* Factory Setting for hardware

† Older versions of the 012 and 008 OPT module require a Ring Generator on the carrier power supply module. Current versions of the 012 and 008 OPT modules, and the 016 module do not require a Ring Generator. Both types can reside together in the system.

Applications*

- Lucent Technologies Attendant†
Notes: _____

- Automated Document Delivery System (ADDS)
Notes: _____

- Call Accounting System (CAS) for Plus V3**
Notes: _____

- Call Accounting System for Windows
Notes: _____

- Call Accounting Terminal (CAT)
 - Business
 - HospitalityNotes: _____

- Call Management System (CMS)†
Notes: _____

- Centrex
Notes: _____

- CONVERSANT®
Notes: _____

- MERLIN Identifier†
Notes: _____

- MERLIN LEGEND Mail/MERLIN MAIL™ Voice Messaging System†
Notes: _____

- MERLIN PFC™ Telephone‡
Notes: _____

- MERLIN LEGEND Reporter
Notes: _____

* *CAUTION: General information about these applications is in the Feature Reference. But to ensure proper operation, you must review the documentation provided with the applications.*

† *Not orderable.*

** *Orderable only as an upgrade to existing CAS installations.*

‡ *Refurbished only.*

Form 1 (Continued)

Group IV Fax

Primary Rate Interface (PRI)

Basic Rate Interface (BRI)

Notes: _____

System Programming and Maintenance (SPM)

Notes: _____

Video Conferencing

Notes: _____

IS II*

IVP/Auto Attendant

AUDIX Voice Power

CAS

SPM

Notes: _____

IS III*

IVP/Auto Attendant

AUDIX Voice Power

CAS

SPM

FAX Attendant System™ Integrated Administration

Notes: _____

PassageWay Direct Connect Solution

Notes: _____

Computer Telephony Integration

NetWare

Windows NT

Telephony Application: _____

Notes: _____

Messaging 2000

Notes: _____

Enhanced Service Center (ESC)

Notes: _____

Other

Notes: _____

* Not Orderable

System Numbering: Extension Jacks

Renumber System* 2-Digit ♦ Selected Extension Numbers 3-Digit Set Up Space No Yes **Networked Switch** No Yes **Centralized Voice Messaging** No Yes

Mod. Type	Log. ID	Jack Type			Equipment	2-Dig. Ext. No.♦	3-Dig. Ext. No.	Set Up Space	Renumber to	Label	Old Ext. No.	Wire No.	Person, Location, or Function	Ring Freq.‡	Appl#	Rot. Dial**	CTI Link††
		A	D†	E													
	1					10	7100										N/A
	2					11	7101										
	3					12	7102										
	4					13	7103										
	5					14	7104										N/A
	6					15	7105										
	7					16	7106										
	8					17	7107										
	9					18	7108										N/A
	10					19	7109										
	11					20	7110										
	12					21	7111										
	13					22	7112										N/A
	14					23	7113										
	15					24	7114										
	16					25	7115										
	17					26	7116										N/A
	18					27	7117										
	19					28	7118										
	20					29	7119										
	21					30	7120										N/A
	22					31	7121										
	23					32	7122										
	24					33	7123										

Shaded lines indicate possible operator positions.
 ♦ Factory Setting
 * The system capacity for Personal Directories is decreased by one whenever an MLX-20L telephone is connected to an MLX port.
 † Use Form 2b for adjuncts connected via MFM.
 ‡ Ringing Frequency is programmable on the 016 T/R module only.
 # The maximum number of VMI ports is 24.
 ** Available in Release 7.0 and later systems.
 †† The maximum number of CTI links is 1.

System Numbering: Extension Jacks

Mod. Type	Log. ID	Jack Type			Equipment	2-Dig. Ext. No.♦	3-Dig. Ext. No.	Set Up Space	Renumber to	Label	Old Ext. No.	Wire No.	Person, Location, or Function	Ring Freq.‡	Appl#	Rot. Dial**	CTI Link††
		A	D†	E													
	25					34	124	7124									N/A
	26					35	125	7125									
	27					36	126	7126									
	28					37	127	7127									
	29					38	128	7128									N/A
	30					39	129	7129									
	31					40	130	7130									
	32					41	131	7131									
	33					42	132	7132									N/A
	34					43	133	7133									
	35					44	134	7134									
	36					45	135	7135									
	37					46	136	7136									N/A
	38					47	137	7137									
	39					48	138	7138									
	40					49	139	7139									
	41					50	140	7140									N/A
	42					51	141	7141									
	43					52	142	7142									
	44					53	143	7143									
	45					54	144	7144									N/A
	46					55	145	7145									
	47					56	146	7146									
	48					57	147	7147									

Shaded lines indicate possible operator positions.
 ♦ Factory Setting
 * The system capacity for Personal Directories is decreased by one whenever an MLX-20L telephone is connected to an MLX port.
 † Use Form 2b for adjuncts connected via MFM.
 ‡ Ringing Frequency is programmable on the 016 T/R module only.
 # The maximum number of VMI ports is 24.
 ** Available in Release 7.0 and later systems.
 †† The maximum number of CTI links is 1.

System Numbering: Extension Jacks

Mod. Type	Log. ID	Jack Type			Equipment	2-Dig. Ext. No. ♦	3-Dig. Ext. No.	Set Up Space	Renumber to	Label	Old Ext. No.	Wire No.	Person, Location, or Function	Ring Freq. ‡	App#	Rot. Dial**	CTI Link††
		A	D†	T E													
	49					58	148	7148									N/A
	50					59	149	7149									
	51					60	150	7150									
	52					61	151	7151									
	53					62	152	7152									N/A
	54					63	153	7153									
	55					64	154	7154									
	56					65	155	7155									
	57					66	156	7156									N/A
	58					6700	157	7157									
	59					6701	158	7158									
	60					6702	159	7159									
	61					6703	160	7160									N/A
	62					6704	161	7161									
	63					6705	162	7162									
	64					6706	163	7163									
	65					6707	164	7164									N/A
	66					6708	165	7165									
	67					6709	166	7166									
	68					6710	167	7167									
	69					6711	168	7168									N/A
	70					6712	169	7169									
	71					6713	170	7170									
	72					6714	171	7171									

Shaded lines indicate possible operator positions.
 ♦ Factory Setting

* The system capacity for Personal Directories is decreased by one whenever an MLX-20L telephone is connected to an MLX port.
 † Use Form 2b for adjuncts connected via MFM.

‡ Ringing Frequency is programmable on the 016 T/R module only.
 # The maximum number of VMI ports is 24.

** Available in Release 7.0 and later systems.
 †† The maximum number of CTI links is 1.

System Numbering: Extension Jacks

Mod. Type	Log. ID	Jack Type			Equipment	2-Dig. Ext. No. ♦	3-Dig. Ext. No.	Set Up Space	Renumber to	Label	Old Ext. No.	Wire No.	Person, Location, or Function	Ring Freq. ‡	App#	Rot. Dial**	CTI Link††
		A	D†	T E													
	73					6715	172	7172								N/A	
	74					6716	173	7173									
	75					6717	174	7174									
	76					6718	175	7175									
	77					6719	176	7176								N/A	
	78					6720	177	7177									
	79					6721	178	7178									
	80					6722	179	7179									
	81					6723	180	7180								N/A	
	82					6724	181	7181									
	83					6725	182	7182									
	84					6726	183	7183									
	85					6727	184	7184								N/A	
	86					6728	185	7185									
	87					6729	186	7186									
	88					6730	187	7187									
	89					6731	188	7188								N/A	
	90					6732	189	7189									
	91					6733	190	7190									
	92					6734	191	7191									
	93					6735	192	7192								N/A	
	94					6736	193	7193									
	95					6737	194	7194									
	96					6738	195	7195									

Shaded lines indicate possible operator positions.

♦ Factory Setting

* The system capacity for Personal Directories is decreased by one whenever an MLX-20L telephone is connected to an MLX port.

† Use Form 2b for adjuncts connected via MFM.

‡ Ringing Frequency is programmable on the 016 T/R module only.

The maximum number of VMI ports is 24.

** Available in Release 7.0 and later systems.

†† The maximum number of CTI links is 1.

System Numbering: Extension Jacks

Mod. Type	Log. ID	Jack Type			Equipment	2-Dig. Ext. No. ♦	3-Dig. Ext. No.	Set Up Space	Renumber to	Label	Old Ext. No.	Wire No.	Person, Location, or Function	Ring Freq. ‡	Appl#	Rot. Dial**	CTI Link††	
		A	D	T E														
	97				6739	196	7196										N/A	
	98				6740	197	7197											
	99				6741	198	7198											
	100				6742	199	7199											
	101				6743	200	7200											N/A
	102				6744	201	7201											
	103				6745	202	7202											
	104				6746	203	7203											
	105				6747	204	7204											N/A
	106				6748	205	7205											
	107				6749	206	7206											
	108				6750	207	7207											
	109				6751	208	7208											N/A
	110				6752	209	7209											
	111				6753	210	7210											
	112				6754	211	7211											
	113				6755	212	7212											N/A
	114				6756	213	7213											
	115				6757	214	7214											
	116				6758	215	7215											
	117				6759	216	7216											N/A
	118				6760	217	7217											
	119				6761	218	7218											
	120				6762	219	7219											

Shaded lines indicate possible operator positions.
 ♦ Factory Setting
 * The system capacity for Personal Directories is decreased by one whenever an MLX-20L telephone is connected to an MLX port.
 † Use Form 2b for adjuncts connected via MFM.
 ‡ Ringing Frequency is programmable on the 016 T/R module only.
 # The maximum number of VMI ports is 24.
 ** Available in Release 7.0 and later systems.
 †† The maximum number of CTI links is 1.

System Numbering: Extension Jacks

Mod. Type	Log. ID	Jack Type			Equipment	2-Dig. Ext. No.♦	3-Dig. Ext. No.	Set Up Space	Renumber to	Label	Old Ext. No.	Wire No.	Person, Location, or Function	Ring Freq.‡	App#	Rot. Dial**	CTI Link††
		A	D†	T E													
	121					6763	220	7220									N/A
	122					6764	221	7221									
	123					6765	222	7222									
	124					6766	223	7223									
	125					6767	224	7224									N/A
	126					6768	225	7225									
	127					6769	226	7226									
	128					6770	227	7227									
	129					6771	228	7228									N/A
	130					6772	229	7229									
	131					6773	230	7230									
	132					6774	231	7231									
	133					6775	232	7232									N/A
	134					6776	233	7233									
	135					6777	234	7234									
	136					6778	235	7235									
	137					6779	236	7236									N/A
	138					6780	237	7237									
	139					6781	238	7238									
	140					6782	239	7239									
	141					6783	240	7240									N/A
	142					6784	241	7241									
	143					6785	242	7242									
	144					6786	243	7243									

Shaded lines indicate possible operator positions.
 ♦ Factory Setting
 * The system capacity for Personal Directories is decreased by one whenever an MLX-20L telephone is connected to an MLX port.
 † Use Form 2b for adjuncts connected via MFM.
 ‡ Ringing Frequency is programmable on the 016 T/R module only.
 # The maximum number of VMI ports is 24.
 ** Available in Release 7.0 and later systems.
 †† The maximum number of CTI links is 1.

System Numbering: Extension Jacks

Mod. Type	Log. ID	Jack Type			Equipment	2-Dig. Ext. No. ♦	3-Dig. Ext. No.	Set Up Space	Renumber to	Label	Old Ext. No.	Wire No.	Person, Location, or Function	Ring Freq. ‡	App#	Rot. Dial**	CTI Link††
		A	D	T E													
	145					6787	244	7244									N/A
	146					6788	245	7245									
	147					6789	246	7246									
	148					6790	247	7247									
	149					6791	248	7248									N/A
	150					6792	249	7249									
	151					6793	250	7250									
	152					6794	251	7251									
	153					6795	252	7252									N/A
	154					6796	253	7253									
	155					6797	254	7254									
	156					6798	255	7255									
	157					6799	256	7256									N/A
	158					6800	257	7257									
	159					6801	258	7258									
	160					6802	259	7259									
	161					6803	260	7260									N/A
	162					6804	261	7261									
	163					6805	262	7262									
	164					6806	263	7263									
	165					6807	264	7264									N/A
	166					6808	265	7265									
	167					6809	266	7266									
	168					6810	267	7267									

Shaded lines indicate possible operator positions.
 ♦ Factory Setting
 * The system capacity for Personal Directories is decreased by one whenever an MLX-20L telephone is connected to an MLX port.
 † Use Form 2b for adjuncts connected via MFM.
 ‡ Ringing Frequency is programmable on the 016 T/R module only.
 # The maximum number of VMI ports is 24.
 ** Available in Release 7.0 and later systems.
 †† The maximum number of CTI links is 1.

System Numbering: Extension Jacks

Mod. Type	Log. ID	Jack Type			Equipment	2-Dig. Ext. No. ♦	3-Dig. Ext. No.	Set Up Space	Renumber to	Label	Old Ext. No.	Wire No.	Person, Location, or Function	Ring Freq. ‡	App#	Rot. Dial**	CTI Link††
		A	D†	T E													
	169					6811	268	7268									N/A
	170					6812	269	7269									
	171					6813	270	7270									
	172					6814	271	7271									
	173					6815	272	7272									N/A
	174					6816	273	7273									
	175					6817	274	7274									
	176					6818	275	7275									
	177					6819	276	7276									N/A
	178					6820	277	7277									
	179					6821	278	7278									
	180					6822	279	7279									
	181					6823	280	7280									N/A
	182					6824	281	7281									
	183					6825	282	7282									
	184					6826	283	7283									
	185					6827	284	7284									N/A
	186					6828	285	7285									
	187					6829	286	7286									
	188					6830	287	7287									
	189					6831	288	7288									N/A
	190					6832	289	7289									
	191					6833	290	7290									
	192					6834	291	7291									

Shaded lines indicate possible operator positions.

♦ Factory Setting

* The system capacity for Personal Directories is decreased by one whenever an MLX-20L telephone is connected to an MLX port.

† Use Form 2b for adjuncts connected via MFM.

‡ Ringing Frequency is programmable on the 016 T/R module only.

The maximum number of VMI ports is 24.

** Available in Release 7.0 and later systems.

†† The maximum number of CTI links is 1.

System Numbering: Extension Jacks

Mod. Type	Log. ID	Jack Type			Equipment	2-Dig. Ext. No. ♦	3-Dig. Ext. No.	Set Up Space	Renumber to	Label	Old Ext. No.	Wire No.	Person, Location, or Function	Ring Freq. ‡	App#	Rot. Dial**	CTI Link††	
		A	D†	T E														
	193				6835	292	7292										N/A	
	194				6836	293	7293											
	195				6837	294	7294											
	196				6838	295	7295											
	197				6839	296	7296											N/A
	198				6840	297	7297											
	198				6841	298	7298											
	200				6842	299	7299											

Shaded lines indicate possible operator positions.

- ♦ Factory Setting
- * The system capacity for Personal Directories is decreased by one whenever an MLX-20L telephone is connected to an MLX port.
- † Use Form 2b for adjuncts connected via MFM.
- ‡ Ringing Frequency is programmable on the 016 T/R module only.
- # The maximum number of VMI ports is 24.
- ** Available in Release 7.0 and later systems.
- †† The maximum number of CTI links is 1.

System Numbering: Digital Adjuncts

(Make additional copies of this form as needed.)

Maximum: 127 Adjuncts

Networked Switch

No

Yes

Log. ID	Factory-Set			Renumber to	Adjuncts	2B	Pass. Bus	MLX Telephone Ext. No.	Person, Location, Function, and Equipment Type
	2-digit	3-digit	Set Up Space						
1	710	300	7300						
2	711	301	7301						
3	712	302	7302						
4	713	303	7303						
5	714	304	7304						
6	715	305	7305						
7	716	306	7306						
8	717	307	7307						
9	718	308	7308						
10	719	309	7309						
11	720	310	7310						
12	721	311	7311						
13	722	312	7312						
14	723	313	7313						
15	724	314	7314						
16	725	315	7315						
17	726	316	7316						
18	727	317	7317						
19	728	318	7318						
20	729	319	7319						
21	730	320	7320						
22	731	321	7321						
23	732	322	7322						
24	733	323	7323						
25	734	324	7324						
26	735	325	7325						
27	736	326	7326						
28	737	327	7327						
29	738	328	7328						
30	739	329	7329						
31	740	330	7330						
32	741	331	7331						
33	742	332	7332						
34	743	333	7333						
35	744	334	7334						
36	745	335	7335						
37	746	336	7336						
38	747	337	7337						
39	748	338	7338						
40	749	339	7339						

System Numbering: Digital Adjuncts

(Make additional copies of this form as needed.)

Maximum: 127 Adjuncts

Log. ID	Factory-Set			Renumber to	Adjuncts	2B	Pass. Bus	MLX Telephone Ext. No.	Person, Location, Function, and Equipment Type
	2-digit	3-digit	Set Up Space						
41	750	340	7340						
42	751	341	7341						
43	752	342	7342						
44	753	343	7343						
45	754	344	7344						
46	755	345	7345						
47	756	346	7346						
48	757	347	7347						
49	758	348	7348						
50	759	349	7349						
51	760	350	7350						
52	761	351	7351						
53	762	352	7352						
54	763	353	7353						
55	764	354	7354						
56	765	355	7355						
57	766	356	7356						
58	6850	357	7357						
59	6851	358	7358						
60	6852	359	7359						
61	6853	360	7360						
62	6854	361	7361						
63	6855	362	7362						
64	6856	363	7363						
65	6857	364	7364						
66	6858	365	7365						
67	6859	366	7366						
68	6860	367	7367						
69	6861	368	7368						
70	6862	369	7369						
71	6863	370	7370						
72	6864	371	7371						
73	6865	372	7372						
74	6866	373	7373						
75	6867	374	7374						
76	6868	375	7375						
77	6869	376	7376						
78	6870	377	7377						
79	6871	378	7378						
80	6872	379	7379						

System Numbering: Digital Adjuncts

(Make additional copies of this form as needed.)

Maximum: 127 Adjuncts

Log. ID	Factory-Set			Renumber to	Adjuncts	2B	Pass. Bus	MLX Telephone Ext. No.	Person, Location, Function, and Equipment Type
	2-digit	3-digit	Set Up Space						
81	6873	380	7380						
82	6874	381	7381						
83	6875	382	7382						
84	6876	383	7383						
85	6877	384	7384						
86	6878	385	7385						
87	6879	386	7386						
88	6880	387	7387						
89	6881	388	7388						
90	6882	389	7389						
91	6883	390	7390						
92	6884	391	7391						
93	6885	392	7392						
94	6886	393	7393						
95	6887	394	7394						
96	6888	395	7395						
97	6889	396	7396						
98	6890	397	7397						
99	6891	398	7398						
100	6892	399	7399						
101	6893	400	7400						
102	6894	401	7401						
103	6895	402	7402						
104	6896	403	7403						
105	6897	404	7404						
106	6898	405	7405						
107	6899	406	7406						
108	6900	407	7407						
109	6901	408	7408						
110	6902	409	7409						
111	6903	410	7410						
112	6904	411	7411						
113	6905	412	7412						
114	6906	413	7413						
115	6907	414	7414						
116	6908	415	7415						
117	6909	416	7416						
118	6910	417	7417						
119	6911	418	7418						
120	6912	419	7419						

System Numbering: Digital Adjuncts

(Make additional copies of this form as needed.)

Maximum: 127 Adjuncts

Log. ID	Factory-Set			Renumber to	Adjuncts	2B	Pass. Bus	MLX Telephone Ext. No.	Person, Location, Function, and Equipment Type
	2-digit	3-digit	Set Up Space						
121	6913	420	7420						
122	6914	421	7421						
123	6915	422	7422						
124	6916	423	7423						
125	6917	424	7424						
126	6918	425	7425						
127	6919	426	7426						
128	6920	427	7427						
129	6921	428	7428						
130	6922	429	7429						
131	6923	430	7430						
132	6924	431	7431						
133	6925	432	7432						
134	6926	433	7433						
135	6927	434	7434						
136	6928	435	7435						
137	6929	436	7436						
138	6930	437	7437						
139	6931	438	7438						
140	6932	439	7439						
141	6933	440	7440						
142	6934	441	7441						
143	6935	442	7442						
144	6936	443	7443						
145	6937	444	7444						
146	6938	445	7445						
147	6939	446	7446						
148	6940	447	7447						
149	6941	448	7448						
150	6942	449	7449						
151	6943	450	7450						
152	6944	451	7451						
153	6945	452	7452						
154	6946	453	7453						
155	6947	454	7454						
156	6948	455	7455						
156	6949	456	7456						
157	6950	457	7457						
158	6951	458	7458						
159	6952	459	7459						

System Numbering: Digital Adjuncts

(Make additional copies of this form as needed.)

Maximum: 127 Adjuncts

Log. ID	Factory-Set			Renumber to	Adjuncts	2B	Pass. Bus	MLX Telephone Ext. No.	Person, Location, Function, and Equipment Type
	2-digit	3-digit	Set Up Space						
160	6953	460	7460						
161	6954	461	7461						
162	6955	462	7462						
163	6956	463	7463						
164	6957	464	7464						
165	6958	465	7465						
166	6959	466	7466						
167	6960	467	7467						
168	6961	468	7468						
169	6962	469	7469						
170	6963	470	7470						
171	6964	471	7471						
172	6965	472	7472						
173	6966	473	7473						
174	6967	474	7474						
175	6968	475	7475						
176	6969	476	7476						
177	6970	477	7477						
178	6971	478	7478						
179	6972	479	7479						
180	6973	480	7480						
181	6974	481	7481						
182	6975	482	7482						
183	6976	483	7483						
184	6977	484	7484						
185	6978	485	7485						
186	6979	486	7486						
187	6980	487	7487						
188	6981	488	7488						
189	6982	489	7489						
190	6983	490	7490						
191	6984	491	7491						
192	6985	492	7492						
193	6986	493	7493						
194	6987	494	7494						
195	6988	495	7495						
196	6989	496	7496						
197	6990	497	7497						
198	6991	498	7498						
199	6992	499	7499						
200	6993	500	7500						

System Numbering: Line/Trunk Jacks

Music On Hold, Line/Trunk No. _____ Source _____ Maintenance Alarm, Line/Trunk No. _____

Loudspeaker Page, Line/Trunk No(s). _____ Loop-Start Reliable Disconnect* No Yes

Module Type and Slot No.	Log. ID	Jack Type (LS, GS, DID, Tie, etc.)	Line/Trunk No.	Pool Dial-Out Code††	Re-number to	Incoming Line/Trunk No., Personal Line, WATS, FX, NI-BRI, etc.)	Telephone Number or Equipment	Label	Outmode Signaling		Toll Type Prefix Req'd for LD		Hold Disc. Interval		QCC Operator to Receive Calls† (No ♦)	QCC Queue Priority Level† (4 ♦)	Function
									TT♦	R	Yes♦	No	Short	Long ♦			
	1		801													
	2		802													
	3		803													
	4		804													
	5		805													
	6		806													
	7		807													
	8		808													
	9		809													
	10		810													
	11		811													
	12		812													
	13		813													
	14		814													
	15		815													
	16		816													
	17		817													
	18		818													
	19		819													
	20		820													

♦ Factory Setting
 * If the system has AUDIX Voice Power/FAX Attendant System™, Integrated Administration will automatically set Loop-Start Reliable Disconnect to Yes.
 † Hybrid/PBX mode only.
 ‡ Maximum: 11 pools with up to 80 trunks per pool.
 Factory settings: 70 (main), 891 (dial-in tie), 892 (automatic-in tie).

System Numbering: Line/Trunk Jacks

Module Type and Slot No.	Log. ID	Jack Type (LS, GS, DID, Tie, etc.)	Line/Trunk No.	Pool Dial-Out Code††	Re-number to	Incoming Line/Trunk Type (Main No., Personal Line, WATS, FX, NI-BRI, etc.)	Telephone Number or Equipment	Label	Outmode Signaling		Toll Type Prefix Req'd for LD		Hold Disc. Interval		QCC Operator to Receive Calls† (No ♦)	QCC Queue Priority Level† (4 ♦)	Function
									TT♦	R	Yes♦	No	Short	Long ♦			
	21		821														
	22		822														
	23		823														
	24		824														
	25		825														
	26		826														
	27		827														
	28		828														
	29		829														
	30		830														
	31		831														
	32		832														
	33		833														
	34		834														
	35		835														
	36		836														
	37		837														
	38		838														
	39		839														
	40		840														

♦ Maximum: 11 pools with up to 80 trunks per pool.
 † Factory settings: 70 (main), 891 (dial-in tie), 892 (automatic-in tie).

♦ Factory Setting
 † Hybrid/PBX mode only.

System Numbering: Line/Trunk Jacks

Module Type and Slot No.	Log. ID	Jack Type (LS, GS, DID, Tie, etc.)	Line/Trunk No.	Pool Dial-Out Code†	Re-number to	Incoming Line/Trunk Type (Main No., Personal Line, WATS, FX, NI-BRI, etc.)	Telephone Number or Equipment	Label	Outmode Signaling		Toll Type Prefix Req'd for LD		Hold Disc. Interval		QCC Operator to Receive Calls† (No ♦)	QCC Queue Priority Level† (4 ♦)	Function
									TT♦	R	Yes♦	No	Short	Long ♦			
	41		841														
	42		842														
	43		843														
	44		844														
	45		845														
	46		846														
	47		847														
	48		848														
	49		849														
	50		850														
	51		851														
	52		852														
	53		853														
	54		854														
	55		855														
	56		856														
	57		857														
	58		858														
	59		859														
	60		860														

♦ Factory Setting
 † Hybrid/PBX mode only.
 ‡ Maximum: 11 pools with up to 80 trunks per pool.
 Factory settings: 70 (main), 891 (dial-in tie), 892 (automatic-in tie).

System Numbering: Line/Trunk Jacks

Module Type and Slot No.	Log. ID	Jack Type (LS, GS, DID, Tie, etc.)	Line/Trunk No.	Pool Dial-Out Code††	Re-number to	Incoming Line/Trunk Type (Main No., Personal Line, WATS, FX, NI-BRI, etc.)	Telephone Number or Equipment	Label	Outmode Signaling		Toll Type Prefix Req'd for LD		Hold Disc. Interval		QCC Operator to Receive Callst (No ♦)	QCC Queue Priority Level† (4 ♦)	Function
									TT♦	R	Yes♦	No	Short	Long ♦			
	61		861														
	62		862														
	63		863														
	64		864														
	65		865														
	66		866														
	67		867														
	68		868														
	69		869														
	70		870														
	71		871														
	72		872														
	73		873														
	74		874														
	75		875														
	76		876														
	77		877														
	78		878														
	79		879														
	80		880														

♦ Factory Setting
 † Hybrid/PBX mode only.
 ‡ Maximum: 11 pools with up to 80 trunks per pool.
 Factory settings: 70 (main), 891 (dial-in tie), 892 (automatic-in tie).

System Numbering: Special Renumbers

Pools* (Form 2c) Description	Factory-Set Number	Renumber to
	70	
	890	
	891	
	892	
	893	
	894	
	895	
	896	
	897	
	898	
	899	

Group Paging (Form 7b) Group ID	Factory-Set Number	Renumber to
	793	
	794	
	795	
	796	
	797	
	798	
	799	

Park Zone (Form 6a) Description	Factory-Set Number	Renumber to
	881	
	882	
	883	
	884	
	885	
	886	
	887	
	888	

DSS Page Buttons	
PAGE 1	Beginning extension for range _____
PAGE 2	Beginning extension for range _____
PAGE 3	Beginning extension for range _____

ARS Dial-Out Code†	Default	Renumber to
XXXX	9	

Group Calling (Form 7d) Group ID Label	Factory-Set Number	Renumber to
	770	
	771	
	772	
	773	
	774	
	775	
	776	
	777	
	778	
	779	
	780	
	781	
	782	
	783	
	784	
	785	
	786	
	787	
	788	
	789	
	790	
	791	
	7920	
	7921	
	7922	
	7923	
	7924‡	
	7925‡	
	7926‡	
	7927‡	
	7928‡	
	7929‡	

Listed Directory Number* (QCC Queue)	Factory-Set Number	Renumber to
XXXX	800	

Remote Access Code (Form 3a)	Factory-Set Number	Renumber to
XXXX	889	

* Hybrid/PBX mode only.
 † ARS Dial-Out Code is Idle Line Preference Code in Key mode.
 ‡ Reserved for AUDIX Voice Power/FAX Attendant System.

Class of Restriction without Barrier Codes

DID* and Tie Trunks

Network Calls

- None
- Tandem
- ARS

Restriction

- Unrestricted
- Outward Restrict ♦
- Toll Restrict

ARS Restriction Level*

- | | |
|------------------------------|----------------------------|
| <input type="checkbox"/> 0 | <input type="checkbox"/> 4 |
| <input type="checkbox"/> 1 | <input type="checkbox"/> 5 |
| <input type="checkbox"/> 2 | <input type="checkbox"/> 6 |
| <input type="checkbox"/> 3 ♦ | |

Disallowed List Access

- List Numbers (0-7)

Non-Tie Trunks

Network Calls

- None
- Tandem
- ARS

Restriction

- Unrestricted
- Outward Restrict ♦
- Toll Restrict

ARS Restriction Level*

- | | |
|------------------------------|----------------------------|
| <input type="checkbox"/> 0 | <input type="checkbox"/> 4 |
| <input type="checkbox"/> 1 | <input type="checkbox"/> 5 |
| <input type="checkbox"/> 2 | <input type="checkbox"/> 6 |
| <input type="checkbox"/> 3 ♦ | |

Disallowed List Access

- List Numbers (0-7)

♦ Factory Setting

* Hybrid/PBX mode only

Class of Restriction with Barrier Codes

Maximum: 16 barrier codes. (Make copies if more than 4 are assigned.)

<p>Barrier Code Number _____ Digits _____ (0-9, plus *)</p> <p>Restriction <input type="checkbox"/> Unrestricted <input type="checkbox"/> Outward Restrict ♦ <input type="checkbox"/> Toll Restrict</p> <p>ARS Restriction Level* <input type="checkbox"/> 0 <input type="checkbox"/> 4 <input type="checkbox"/> 1 <input type="checkbox"/> 5 <input type="checkbox"/> 2 <input type="checkbox"/> 6 <input type="checkbox"/> 3 ♦</p> <p>Disallowed List Access <input type="checkbox"/> List Numbers (0-7) _____ _____</p>

<p>Barrier Code Number _____ Digits _____ (0-9, plus *)</p> <p>Restriction <input type="checkbox"/> Unrestricted <input type="checkbox"/> Outward Restrict ♦ <input type="checkbox"/> Toll Restrict</p> <p>ARS Restriction Level* <input type="checkbox"/> 0 <input type="checkbox"/> 4 <input type="checkbox"/> 1 <input type="checkbox"/> 5 <input type="checkbox"/> 2 <input type="checkbox"/> 6 <input type="checkbox"/> 3 ♦</p> <p>Disallowed List Access <input type="checkbox"/> List Numbers (0-7) _____ _____</p>

<p>Barrier Code Number _____ Digits _____ (0-9, plus *)</p> <p>Restriction <input type="checkbox"/> Unrestricted <input type="checkbox"/> Outward Restrict ♦ <input type="checkbox"/> Toll Restrict</p> <p>ARS Restriction Level* <input type="checkbox"/> 0 <input type="checkbox"/> 4 <input type="checkbox"/> 1 <input type="checkbox"/> 5 <input type="checkbox"/> 2 <input type="checkbox"/> 6 <input type="checkbox"/> 3 ♦</p> <p>Disallowed List Access <input type="checkbox"/> List Numbers (0-7) _____ _____</p>

<p>Barrier Code Number _____ Digits _____ (0-9, plus *)</p> <p>Restriction <input type="checkbox"/> Unrestricted <input type="checkbox"/> Outward Restrict ♦ <input type="checkbox"/> Toll Restrict</p> <p>ARS Restriction Level* <input type="checkbox"/> 0 <input type="checkbox"/> 4 <input type="checkbox"/> 1 <input type="checkbox"/> 5 <input type="checkbox"/> 2 <input type="checkbox"/> 6 <input type="checkbox"/> 3 ♦</p> <p>Disallowed List Access <input type="checkbox"/> List Numbers (0-7) _____ _____</p>

♦ Factory Setting
* Hybrid/PBX mode only

Incoming Trunks: DS1 Connectivity (100D Module)

Module 1 Slot No. _____

Type of Service <input type="checkbox"/> T1 ♦* <input type="checkbox"/> PRI†‡	Switch Type (PRI Service Only) <input type="checkbox"/> 4ESS♦‡† <input type="checkbox"/> DEX600E <input type="checkbox"/> 5ESS‡ <input type="checkbox"/> Legend-PBX <input type="checkbox"/> DMS-100 <input type="checkbox"/> Legend-NTWK <input type="checkbox"/> DMS-250	Frame Format <input type="checkbox"/> D4 Compatible ♦ <input type="checkbox"/> Extended Superframe (ESF) <input type="checkbox"/> B8ZS	Clock Synchronization Priority <input type="checkbox"/> Primary ♦ <input type="checkbox"/> Secondary <input type="checkbox"/> Tertiary <input type="checkbox"/> None Source <input type="checkbox"/> Loop ♦ <input type="checkbox"/> Local Activation <input type="checkbox"/> Active ♦ <input type="checkbox"/> Not Active																																																																				
T1 Trunks <table border="1" style="width:100%; border-collapse: collapse; text-align: center;"> <thead> <tr> <th rowspan="2">Trunk Type</th> <th rowspan="2">Channel Number(s)</th> <th colspan="3">For Tie/All Tie</th> </tr> <tr> <th>Tie-PBX</th> <th>Toll</th> <th>S56</th> </tr> </thead> <tbody> <tr><td>Ground-Start</td><td></td><td>X</td><td>X</td><td>X</td></tr> <tr><td>Loop-Start</td><td></td><td>X</td><td>X</td><td>X</td></tr> <tr><td>Tie</td><td></td><td>X</td><td>X</td><td>X</td></tr> <tr><td>Unequipped</td><td></td><td>X</td><td>X</td><td>X</td></tr> <tr><td>All Ground-Start</td><td></td><td>X</td><td>X</td><td>X</td></tr> <tr><td>All Loop-Start</td><td></td><td>X</td><td>X</td><td>X</td></tr> <tr><td>All Tie</td><td></td><td>X</td><td>X</td><td>X</td></tr> <tr><td>All Unequipped</td><td></td><td>X</td><td>X</td><td>X</td></tr> <tr><td>DID</td><td></td><td>X</td><td>X</td><td>X</td></tr> <tr><td>All DID</td><td></td><td>X</td><td>X</td><td>X</td></tr> <tr><td>S56 Data</td><td></td><td>X</td><td>X</td><td>X</td></tr> <tr><td>All S56 Data</td><td></td><td>X</td><td>X</td><td>X</td></tr> </tbody> </table>		Trunk Type	Channel Number(s)	For Tie/All Tie			Tie-PBX	Toll	S56	Ground-Start		X	X	X	Loop-Start		X	X	X	Tie		X	X	X	Unequipped		X	X	X	All Ground-Start		X	X	X	All Loop-Start		X	X	X	All Tie		X	X	X	All Unequipped		X	X	X	DID		X	X	X	All DID		X	X	X	S56 Data		X	X	X	All S56 Data		X	X	X	Suppression (Line Code) <input type="checkbox"/> AMI-ZCS ♦ <input type="checkbox"/> B8ZS	Signaling Mode (Not for PRI) <input type="checkbox"/> Robbed-Bit Signaling (RBS) ♦ <input type="checkbox"/> Common-Channel Signaling (CCS)
Trunk Type	Channel Number(s)			For Tie/All Tie																																																																			
		Tie-PBX	Toll	S56																																																																			
Ground-Start		X	X	X																																																																			
Loop-Start		X	X	X																																																																			
Tie		X	X	X																																																																			
Unequipped		X	X	X																																																																			
All Ground-Start		X	X	X																																																																			
All Loop-Start		X	X	X																																																																			
All Tie		X	X	X																																																																			
All Unequipped		X	X	X																																																																			
DID		X	X	X																																																																			
All DID		X	X	X																																																																			
S56 Data		X	X	X																																																																			
All S56 Data		X	X	X																																																																			
		Line Compensation _____ Cable Feet <input type="checkbox"/> 1 (-.6 dB) ♦ <input type="checkbox"/> 2 (-1.2 dB) <input type="checkbox"/> 3 (-1.8 dB) <input type="checkbox"/> 4 (-2.4 dB) <input type="checkbox"/> 5 (-3.0 dB)	Channel Service Unit <input type="checkbox"/> Foreign Exchange ♦ <input type="checkbox"/> Special Access																																																																				

Module 2 Slot No. _____

Type of Service <input type="checkbox"/> T1 ♦* <input type="checkbox"/> PRI†‡	Switch Type (PRI Service Only) <input type="checkbox"/> 4ESS♦‡† <input type="checkbox"/> DEX600E <input type="checkbox"/> 5ESS‡ <input type="checkbox"/> Legend-PBX <input type="checkbox"/> DMS-100 <input type="checkbox"/> Legend-NTWK <input type="checkbox"/> DMS-250	Frame Format <input type="checkbox"/> D4 Compatible ♦ <input type="checkbox"/> Extended Superframe (ESF) <input type="checkbox"/> B8ZS	Clock Synchronization Priority <input type="checkbox"/> Primary ♦ <input type="checkbox"/> Secondary <input type="checkbox"/> Tertiary <input type="checkbox"/> None Source <input type="checkbox"/> Loop ♦ <input type="checkbox"/> Local Activation <input type="checkbox"/> Active ♦ <input type="checkbox"/> Not Active																																																																				
T1 Trunks <table border="1" style="width:100%; border-collapse: collapse; text-align: center;"> <thead> <tr> <th rowspan="2">Trunk Type</th> <th rowspan="2">Channel Number(s)</th> <th colspan="3">For Tie/All Tie</th> </tr> <tr> <th>Tie-PBX</th> <th>Toll</th> <th>S56</th> </tr> </thead> <tbody> <tr><td>Ground-Start</td><td></td><td>X</td><td>X</td><td>X</td></tr> <tr><td>Loop-Start</td><td></td><td>X</td><td>X</td><td>X</td></tr> <tr><td>Tie</td><td></td><td>X</td><td>X</td><td>X</td></tr> <tr><td>Unequipped</td><td></td><td>X</td><td>X</td><td>X</td></tr> <tr><td>All Ground-Start</td><td></td><td>X</td><td>X</td><td>X</td></tr> <tr><td>All Loop-Start</td><td></td><td>X</td><td>X</td><td>X</td></tr> <tr><td>All Tie</td><td></td><td>X</td><td>X</td><td>X</td></tr> <tr><td>All Unequipped</td><td></td><td>X</td><td>X</td><td>X</td></tr> <tr><td>DID</td><td></td><td>X</td><td>X</td><td>X</td></tr> <tr><td>All DID</td><td></td><td>X</td><td>X</td><td>X</td></tr> <tr><td>S56 Data</td><td></td><td>X</td><td>X</td><td>X</td></tr> <tr><td>All S56 Data</td><td></td><td>X</td><td>X</td><td>X</td></tr> </tbody> </table>		Trunk Type	Channel Number(s)	For Tie/All Tie			Tie-PBX	Toll	S56	Ground-Start		X	X	X	Loop-Start		X	X	X	Tie		X	X	X	Unequipped		X	X	X	All Ground-Start		X	X	X	All Loop-Start		X	X	X	All Tie		X	X	X	All Unequipped		X	X	X	DID		X	X	X	All DID		X	X	X	S56 Data		X	X	X	All S56 Data		X	X	X	Suppression (Line Code) <input type="checkbox"/> AMI-ZCS ♦ <input type="checkbox"/> B8ZS	Signaling Mode (not for PRI) <input type="checkbox"/> Robbed-Bit Signaling (RBS) ♦ <input type="checkbox"/> Common-Channel Signaling (CCS)
Trunk Type	Channel Number(s)			For Tie/All Tie																																																																			
		Tie-PBX	Toll	S56																																																																			
Ground-Start		X	X	X																																																																			
Loop-Start		X	X	X																																																																			
Tie		X	X	X																																																																			
Unequipped		X	X	X																																																																			
All Ground-Start		X	X	X																																																																			
All Loop-Start		X	X	X																																																																			
All Tie		X	X	X																																																																			
All Unequipped		X	X	X																																																																			
DID		X	X	X																																																																			
All DID		X	X	X																																																																			
S56 Data		X	X	X																																																																			
All S56 Data		X	X	X																																																																			
		Line Compensation _____ Cable Feet <input type="checkbox"/> 1 (-.6 dB) ♦ <input type="checkbox"/> 2 (-1.2 dB) <input type="checkbox"/> 3 (-1.8 dB) <input type="checkbox"/> 4 (-2.4 dB) <input type="checkbox"/> 5 (-3.0 dB)	Channel Service Unit <input type="checkbox"/> Foreign Exchange ♦ <input type="checkbox"/> Special Access																																																																				

NOTE: Do not configure 100D modules to do trunk-to-trunk transfers between DS1 and LS lines/trunks.

♦ Factory Setting

* The factory setting of T1 is **not** automatically selected if you enter nothing; it must be entered.

† PRI must be selected as the Type of DS1 connectivity before PRI options are entered.

‡ AT&T Toll and 5ESS local PRI service for Release 2.0 and later requires service provider switching equipment to be either 4ESS Generic 13 through Generic 16, 5ESS Generic 6, or a 5ESS serving the FTS2000 network. PRI service on Release 1.0 or 1.1 requires a DS1 facility from a 4ESS Generic 13 through Generic 16 or 4ESS Generic 16 switch.

Module 3 Slot No. _____

Type of Service <input type="checkbox"/> T1 ♦* <input type="checkbox"/> PRI†‡	Switch Type (PRI Service Only) <input type="checkbox"/> 4ESS♦*‡ <input type="checkbox"/> DEX600E <input type="checkbox"/> 5ESS‡ <input type="checkbox"/> Legend-PBX <input type="checkbox"/> DMS-100 <input type="checkbox"/> Legend-NTWK <input type="checkbox"/> DMS-250	Frame Format <input type="checkbox"/> D4 Compatible ♦ <input type="checkbox"/> Extended Superframe (ESF)	Clock Synchronization Priority <input type="checkbox"/> Primary ♦ <input type="checkbox"/> Secondary <input type="checkbox"/> Tertiary <input type="checkbox"/> None
T1 Trunks		Suppression (Line Code) <input type="checkbox"/> AMI-ZCS ♦ <input type="checkbox"/> B8ZS	<input type="checkbox"/> Robbed-Bit Signaling (RBS) ♦ <input type="checkbox"/> Common-Channel Signaling (CCS)
		Signaling Mode (not for PRI) <input type="checkbox"/> Robbed-Bit Signaling (RBS) ♦ <input type="checkbox"/> Common-Channel Signaling (CCS)	Source <input type="checkbox"/> Loop ♦ <input type="checkbox"/> Local
		Line Compensation _____ Cable Feet <input type="checkbox"/> 1 (-.6 dB) ♦ <input type="checkbox"/> 2 (-1.2 dB) <input type="checkbox"/> 3 (-1.8 dB) <input type="checkbox"/> 4 (-2.4 dB) <input type="checkbox"/> 5 (-3.0 dB)	Activation <input type="checkbox"/> Active ♦ <input type="checkbox"/> Not Active
			Channel Service Unit <input type="checkbox"/> Foreign Exchange ♦ <input type="checkbox"/> Special Access

Trunk Type	Channel Number(s)	For Tie/All Tie		
		Tie-PBX	Toll	S56
Ground-Start		X	X	X
Loop-Start		X	X	X
Tie		X	X	X
Unequipped		X	X	X
All Ground-Start		X	X	X
All Loop-Start		X	X	X
All Tie		X	X	X
All Unequipped		X	X	X
DID		X	X	X
All DID		X	X	X
S56 Data		X	X	X
All S56 Data		X	X	X

NOTE: Do not configure 100D modules to do trunk-to-trunk transfers between DS1 and LS lines/trunks.

♦ Factory Setting

* The factory setting of T1 is **not** automatically selected if you enter nothing; it must be entered.

† PRI must be selected as the Type of DS1 connectivity before PRI options are entered.

‡ AT&T Toll and 5ESS local PRI service for Release 2.0 and later requires service provider switching equipment to be either 4ESS Generic 13 through Generic 16, 5ESS Generic 6, or a 5ESS serving the FTS2000 network. PRI service on Release 1.0 or 1.1 requires a DS1 facility from a 4ESS Generic 13 through Generic 16 or 4ESS Generic 16 switch.

Form 3b (Continued)

PRI Services

Maximum: 3 Modules. (Make copies of this page for additional modules.)

Module Slot No. _____

B-Channel Group No.	Outgoing Services*	Incoming Services*	Incoming Routing	
			Dial Plan Routing†‡	Line Appearance§

* *Services:*
 AT&T Toll: Megacom WATS, Megacom 800, ACCUNET® SDS, Software Defined Network (SDN), MultiQuest, Long Distance.
 5ESS Local: OUTWATS, 56/64 Digital, Virtual Private Network, INWATS.
 MCI Toll: MCI PRISM, MCI Vnet, MCI 800, MCI 900
 DMS-100 Local: DMS Private, DMS INWATS, DMS OUTWATS, DMS Foreign Exchange (FX), DMS Tie Trunk.
 Other: Call-by-Call, Other.

† Hybrid/PBX mode only.

‡ If you select Dial Plan Routing, complete "Dial Plan Routing" information on Form 3b-6.

§ If you select Line Appearance, complete "Line Appearance Routing" information on Form 3b-5.

Dial Plan Routing (Incoming Services)*

Maximum: 16 entries

Entry No.	0	1	2	3	4	5	6	7
Service†								
Pattern to Match‡								
Total Digits in Dialed Number (0-14)								
Delete Digits (0-14)								
Add Digits (0-4)								

Entry No.	8	9	10	11	12	13	14	15
Service†								
Pattern to Match‡								
Total Digits in Dialed Number (0-14)								
Delete Digits (0-14)								
Add Digits (0-4)								

* Hybrid/PBX mode only.

† Services:

AT&T Toll: Megacom WATS, Megacom 800, ACCUNET® SDS, Software Defined Network (SDN), MultiQuest, Long Distance.

5ESS Local: OUTWATS, 56/64 Digital, Virtual Private Network, INWATS.

MCI Toll: MCI PRISM, MCI Vnet, MCI 800, MCI 900

DMS-100 Local: DMS Private, DMS INWATS, DMS OUTWATS, DMS Foreign Exchange (FX), DMS Tie Trunk.

Other: Call-by-Call, Other.

‡ Pattern of up to 8 digits.

Outgoing Tables (Outgoing Services)

Network Selection Table

Maximum: 4 entries

Entry No.	0♦	1♦	2	3
Dial Prefix*	101***	10***		

Special Services Table

Maximum: 8 entries

Entry No.	0	1	2	3	4	5	6	7
Pattern to Match†	011	010	01	00	0	1		
Operator‡	none	OP	OP	P	OP	none		
Type of No. (N=Nat'l; I=Int'l)	I	I	I	N	N	N		
Delete Digits (0-4)	3	3	2	2	1	1		

♦ Defaults.

* Dial Pattern can be up to 8 digits (* is a wildcard); must include at least one number; cannot begin with *.

† Pattern can be up to 4 digits; no asterisks(*).

‡ Operator: Local Operator (OP), Presubscribed Carrier (P), No operator (none).

Call-By-Call Service Table

Maximum: 10 entries

Entry No.	0	1	2	3	4
Pattern to Match (up to 10 entries)					
Call Type (Voice/Data/Both)					
Service*					
Delete Digits (0-8)					

Entry No.	5	6	7	8	9
Pattern to match (up to 10 entries)					
Call-Type (Voice/Data/Both)					
Service*					
Delete Digits (0-8)					

* Services:

AT&T Toll: Megacom WATS, Megacom 800, ACCUNET® SDS, Software Defined Network (SDN), MultiQuest, Long Distance.
 5ESS Local: OUTWATS, 56/64 Digital, Virtual Private Network, INWATS.
 MCI Toll: MCI PRISM, MCI Vnet, MCI 800, MCI 900
 DMS-100 Local: DMS Private, DMS INWATS, DMS OUTWATS, DMS Foreign Exchange (FX), DMS Tie Trunk.
 Other: Call-by-Call, Other.

Test Telephone Numbers

Module 1: _____ **Module 2:** _____ **Module 3:** _____

PRI Protocol

Timers and Counters

	Factory Setting	Change to
T200 Timer	1 second	(1000–3000 ms)
T203 Timer	30 seconds	(1–60 seconds)
N200 Counter	3 transmissions	(1–5 transmissions)
N201 Counter	260 octets	(16–260 octets)
K Counter	7 frames	(1–15 frames)
T303 Timer	4 seconds	(4–12 seconds)
T305 Timer	4 seconds	(4–30 seconds)
T308 Timer	4 seconds	(4–12 seconds)
T309 Timer	90 seconds	(30–120 seconds)
T310 Timer	60 seconds	(2–120 seconds)
T313 Timer	4 seconds	(4–60 seconds)
T316 Timer	120 seconds	(3–120 seconds)

Terminal Equipment Identifier (TEI)

- 0 ♦
- _____ (1–63)

♦ *Factory Setting*

T1 Switch 56 Options*

Maximum: 3 modules (Make additional copies of this page as needed.)

Module Slot No.: _____ **Channel No.:** _____

Type

- Incoming
- Outgoing
- Two Way ♦

Incoming Signaling Type

- Wink ♦
- Auto
- Delay

Outgoing Signaling Type

- Wink ♦
- Auto
- Delay

Incoming Signaling Mode

- Rotary
- Touch-tone ♦

Incoming Signaling Mode

- Rotary
- Touch-tone ♦

Dial Plan Routing Options

Expected Digits

- 1
- 2
- 3 ♦
- 4

Delete Digits

- 0 ♦
- 1
- 2
- 3
- 4

Add Digits

- 0 digits ♦
- Add these digits _____
(Any number from 1–9999)

♦ Factory Setting

* T1 must be selected as the Type of DS1 connectivity. The T1 Truck Type must be configured as S56 (not T1-tie).

Incoming Trunks: DID*

(Make copies for each block.)

Block Number (1 or 2) _____

Type

- Immediate-Start
- Wink-Start ◆

Expected Digits

- 1
- 2
- 3 ◆
- 4

Delete Digits

- 0 ◆
- 1
- 2
- 3
- 4

Add Digits

- 0 digits ◆
- Add these digits _____
(any number from 1–9999)

Signaling

- Rotary ◆
- Touch-tone

Invalid Destination

- Send to backup position ◆
- Return to fast busy

Trunks Included in Block

Logical ID	Trunk No.	Telephone No.	Disconnect Time	
			500 ms◆	Other (10 to 2550)

◆ Factory Setting
* Hybrid/PBX mode only

Automatic Route Selection Tables*

Maximum: 16 Tables. (Make a copy for each table.)

Table No. _____

Type of Table

- 6-Digit
- Area Code
- Exchange
- 1 + 7, dialing from
 - within area code
 - not within area code ◆

Area Code/Exchanges

001_____	021_____	041_____	061_____	081_____
002_____	022_____	042_____	062_____	082_____
003_____	023_____	043_____	063_____	083_____
004_____	024_____	044_____	064_____	084_____
005_____	025_____	045_____	065_____	085_____
006_____	026_____	046_____	066_____	086_____
007_____	027_____	047_____	067_____	087_____
008_____	028_____	048_____	068_____	088_____
009_____	029_____	049_____	069_____	089_____
010_____	030_____	050_____	070_____	090_____
011_____	031_____	051_____	071_____	091_____
012_____	032_____	052_____	072_____	092_____
013_____	033_____	053_____	073_____	093_____
014_____	034_____	054_____	074_____	094_____
015_____	035_____	055_____	075_____	095_____
016_____	036_____	056_____	076_____	096_____
017_____	037_____	057_____	077_____	097_____
018_____	038_____	058_____	078_____	098_____
019_____	039_____	059_____	079_____	099_____
020_____	040_____	060_____	080_____	100_____

Subpattern A Time of Day				
Pool	FRL (3 ◆)‡	Other Digits	Absorb	Call Type† (Both ◆)
1_____	_____	_____	1_____	_____
2_____	_____	_____	2_____	_____
3_____	_____	_____	3_____	_____
4_____	_____	_____	4_____	_____
5_____	_____	_____	5_____	_____
6_____	_____	_____	6_____	_____

Subpattern B Time of Day				
Pool	FRL (3 ◆)‡	Other Digits	Absorb	Call Type† (Both ◆)
1_____	_____	_____	1_____	_____
2_____	_____	_____	2_____	_____
3_____	_____	_____	3_____	_____
4_____	_____	_____	4_____	_____
5_____	_____	_____	5_____	_____
6_____	_____	_____	6_____	_____

◆ Factory Setting

* Hybrid/PBX mode only

† Select Voice only, Data only, or Both.

‡ Local tables default FRL is 2.

Table No. _____

Type of Table

- 6-Digit
- Area Code
- Exchange
- 1 + 7, dialing from
 - within area code
 - not within area code ♦

Area Code/Exchanges

001_____	021_____	041_____	061_____	081_____
002_____	022_____	042_____	062_____	082_____
003_____	023_____	043_____	063_____	083_____
004_____	024_____	044_____	064_____	084_____
005_____	025_____	045_____	065_____	085_____
006_____	026_____	046_____	066_____	086_____
007_____	027_____	047_____	067_____	087_____
008_____	028_____	048_____	068_____	088_____
009_____	029_____	049_____	069_____	089_____
010_____	030_____	050_____	070_____	090_____
011_____	031_____	051_____	071_____	091_____
012_____	032_____	052_____	072_____	092_____
013_____	033_____	053_____	073_____	093_____
014_____	034_____	054_____	074_____	094_____
015_____	035_____	055_____	075_____	095_____
016_____	036_____	056_____	076_____	096_____
017_____	037_____	057_____	077_____	097_____
018_____	038_____	058_____	078_____	098_____
019_____	039_____	059_____	079_____	099_____
020_____	040_____	060_____	080_____	100_____

Subpattern A Time of Day					Subpattern B Time of Day				
Pool	FRL (3 ♦) ‡	Other Digits	Absorb	Call Type† (Both ♦)	Pool	FRL (3 ♦) ‡	Other Digits	Absorb	Call Type† (Both ♦)
1_____	_____	_____	1_____	_____	1_____	_____	_____	1_____	_____
2_____	_____	_____	2_____	_____	2_____	_____	_____	2_____	_____
3_____	_____	_____	3_____	_____	3_____	_____	_____	3_____	_____
4_____	_____	_____	4_____	_____	4_____	_____	_____	4_____	_____
5_____	_____	_____	5_____	_____	5_____	_____	_____	5_____	_____
6_____	_____	_____	6_____	_____	6_____	_____	_____	6_____	_____

♦ Factory Setting
 * Select Voice only, Data only, or Both.
 ‡ Local tables default FRL is 2.

Automatic Route Selection Default and Special Numbers Tables*

Table 17: Default Toll Table

Subpattern A Time of Day					Subpattern B Time of Day				
Pool	FRL (3 ♦)	Other Digits	Absorb	Call Type† (Both ♦)	Pool	FRL (3 ♦)	Other Digits	Absorb	Call Type† (Both ♦)
1 _____	_____	_____	1 _____	_____	1 _____	_____	_____	1 _____	_____
2 _____	_____	_____	2 _____	_____	2 _____	_____	_____	2 _____	_____
3 _____	_____	_____	3 _____	_____	3 _____	_____	_____	3 _____	_____
4 _____	_____	_____	4 _____	_____	4 _____	_____	_____	4 _____	_____
5 _____	_____	_____	5 _____	_____	5 _____	_____	_____	5 _____	_____
6 _____	_____	_____	6 _____	_____	6 _____	_____	_____	6 _____	_____

Table 18: Default Local Table

Subpattern A Time of Day					Subpattern B Time of Day				
Pool	FRL (2 ♦)	Other Digits	Absorb	Call Type† (Both ♦)	Pool	FRL (2 ♦)	Other Digits	Absorb	Call Type† (Both ♦)
1 _____	_____	_____	1 _____	_____	1 _____	_____	_____	1 _____	_____
2 _____	_____	_____	2 _____	_____	2 _____	_____	_____	2 _____	_____
3 _____	_____	_____	3 _____	_____	3 _____	_____	_____	3 _____	_____
4 _____	_____	_____	4 _____	_____	4 _____	_____	_____	4 _____	_____
5 _____	_____	_____	5 _____	_____	5 _____	_____	_____	5 _____	_____
6 _____	_____	_____	6 _____	_____	6 _____	_____	_____	6 _____	_____

Table 19: Dial 0

Pool	FRL (3 ♦)	Other Digits
1 _____	_____	_____

Table 20: Special Number (411, 611, 811, 911)

Pool‡	FRL (3 ♦)	Other Digits
1 70 _____	_____	_____

♦ Factory Setting

* Hybrid/PBX mode only

† Select Voice only, Data only, or Both.

‡ Always set to the first pool in the system; cannot be changed.

LS-ID Delay

Note: Only for lines attached to 800 GS/LS-ID, 408 GS/LS-MLX-ID, or 412 LS/ETR-ID modules.

Line	Yes	No ♦
1		
2		
3		
4		
5		
6		
7		
8		
9		
10		
11		
12		
13		
14		
15		
16		
17		
18		
19		
20		
21		
22		
23		
24		
25		
26		
27		
28		
29		
30		

Line	Yes	No ♦
31		
32		
33		
34		
35		
36		
37		
38		
39		
40		
41		
42		
43		
44		
45		
46		
47		
48		
49		
50		
51		
52		
53		
54		
55		
56		
57		
58		
59		
60		

Line	Yes	No ♦
61		
62		
63		
64		
65		
66		
67		
68		
69		
70		
71		
72		
73		
74		
75		
76		
77		
78		
79		
80		

♦ Factory Setting

Clock Synchronization—100D or BRI Modules*

Primary Clock Synchronization

Slot No. _____
DSL No. _____ (BRI only)

Source

- Loop
- Local (100D only)

Secondary Clock Synchronization

Slot No. _____
DSL No. _____ (BRI only)

Source

- Loop ♦
- Local (100D only)

Tertiary Clock Synchronization

Slot No. _____
DSL No. _____ (BRI only)

Source

- Loop ♦
- Local (100D only)

Timers

T200 Timer

- 1,000 ms. ♦
- _____ ms. (500 to 5,000 ms. in increments of 500 ms)

T203 Timer

- 33 seconds ♦
- _____ seconds (10 to 255 seconds in increments of 1 second)

T303 Timer

- 4 seconds ♦
- _____ seconds (2 to 10 seconds in increments of 1 second)

T305 Timer

- 30 seconds ♦
- _____ seconds (2 to 60 seconds in increments of 1 second)

T308 Timer

- 4 seconds ♦
- _____ seconds (2 to 10 seconds in increments of 1 second)

♦ *Factory Setting*

* *If the system includes both 800 NI-BRI modules and 100D modules, synchronization planning should be completed at the same time. Refer to Form 3b while completing this form.*

Button Diagram

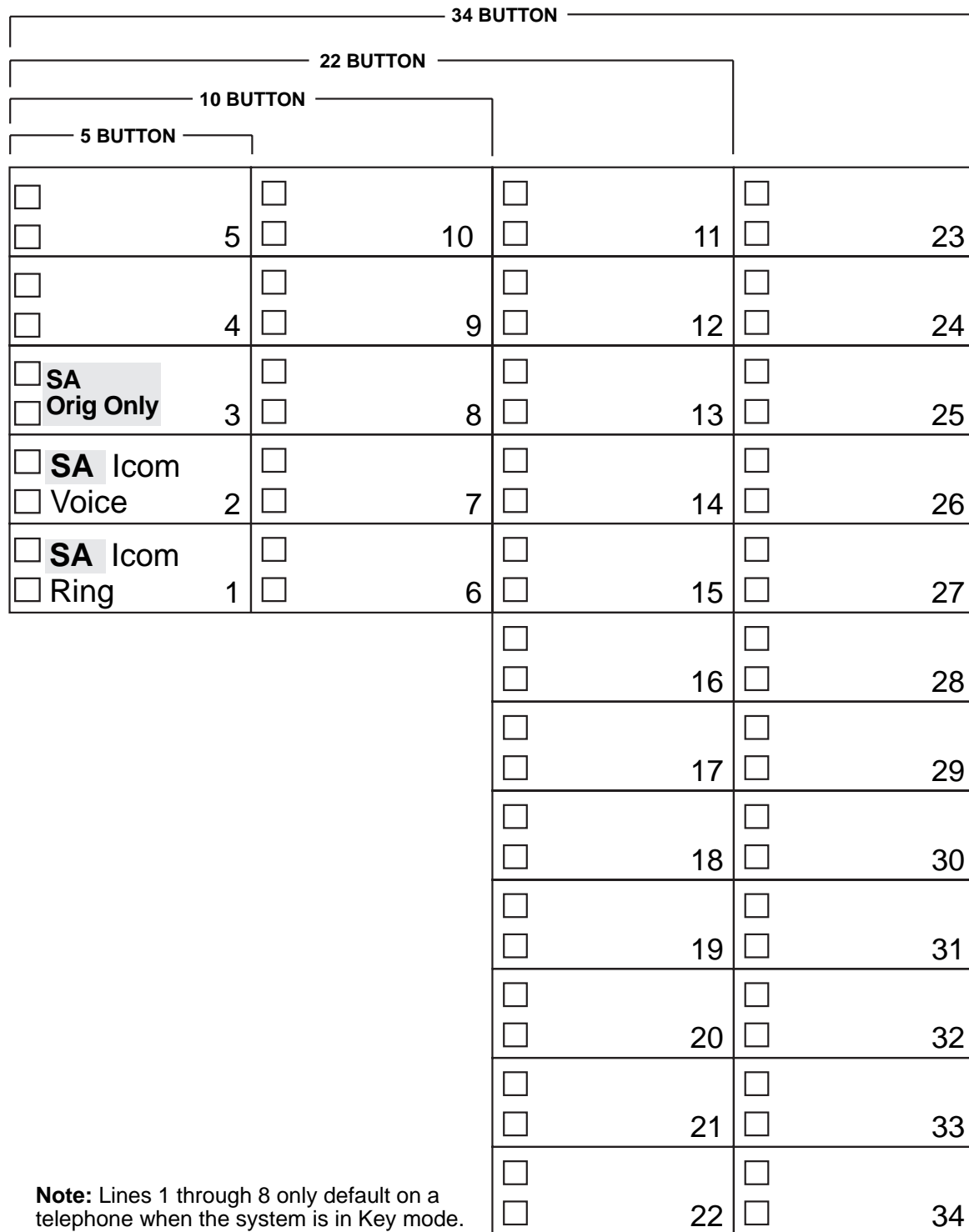

Analog Multiline Telephone

(Make a copy of this form for each telephone.)

Logical ID _____ Extension No. _____ Person or Location _____

Copied from Master Ext. No. _____

Extension Jack Pair

- Voice Announce to Busy (voice/voice)
- Simultaneous Voice and Data (voice/data)

Even-numbered jack

Logical ID _____ Ext. No. _____

Telephone Model

- MLC-5 BIS-22D
- BIS-10 BIS-34
- BIS- 22 BIS-34D
- Other _____

Adjuncts

- General Purpose Adapter
 - FAX machine
 - Answering machine
 - Data terminal
 - Other _____
- Supplemental Alert Adapter
Alert device type _____
- Headset
- Headset adapter
- Hands-free unit
- Hearing-impaired handset
- Noisy environment
- Off Premises
- Other _____

Personal Lines

Shared Extension No. _____

- Ring
- No Ring

Auto Line Selection

Optional Features

Abbreviated Ring

- Off
- On ♦

Auto Callback

- Off ♦
- On

Call Waiting

- Off ♦
- On

Voice-Announced Calls

- On ♦
- Off

Coverage Inside

- Off
- On ♦

Computer Telephony Integrated Client PC

- Yes
- No ♦

Cover Ring Delay

Primary Cover Ring Delay

- 2 Rings ♦
- ____rings (1-6)

Secondary Cover Ring Delay

- 2 Rings ♦
- ____rings (1-6)

Group Coverage Ring Delay

- 3 Rings ♦
- ____rings (1-9)

♦ Factory Setting

Button Diagram

See Master Extension

34 BUTTON			
22 BUTTON			
10 BUTTON			
5 BUTTON			
<input type="checkbox"/>	<input type="checkbox"/>	<input type="checkbox"/>	<input type="checkbox"/>
<input type="checkbox"/> 5	<input type="checkbox"/> 10	<input type="checkbox"/> 11	<input type="checkbox"/> 23
<input type="checkbox"/>	<input type="checkbox"/>	<input type="checkbox"/>	<input type="checkbox"/>
<input type="checkbox"/> 4	<input type="checkbox"/> 9	<input type="checkbox"/> 12	<input type="checkbox"/> 24
<input type="checkbox"/> SA	<input type="checkbox"/>	<input type="checkbox"/>	<input type="checkbox"/>
<input type="checkbox"/> Orig Only 3	<input type="checkbox"/> 8	<input type="checkbox"/> 13	<input type="checkbox"/> 25
<input type="checkbox"/> SA Icom	<input type="checkbox"/>	<input type="checkbox"/>	<input type="checkbox"/>
<input type="checkbox"/> Voice 2	<input type="checkbox"/> 7	<input type="checkbox"/> 14	<input type="checkbox"/> 26
<input type="checkbox"/> SA Icom	<input type="checkbox"/>	<input type="checkbox"/>	<input type="checkbox"/>
<input type="checkbox"/> Ring 1	<input type="checkbox"/> 6	<input type="checkbox"/> 15	<input type="checkbox"/> 27
		<input type="checkbox"/>	<input type="checkbox"/>
		<input type="checkbox"/> 16	<input type="checkbox"/> 28
		<input type="checkbox"/>	<input type="checkbox"/>
		<input type="checkbox"/> 17	<input type="checkbox"/> 29
		<input type="checkbox"/>	<input type="checkbox"/>
		<input type="checkbox"/> 18	<input type="checkbox"/> 30
		<input type="checkbox"/>	<input type="checkbox"/>
		<input type="checkbox"/> 19	<input type="checkbox"/> 31
		<input type="checkbox"/>	<input type="checkbox"/>
		<input type="checkbox"/> 20	<input type="checkbox"/> 32
		<input type="checkbox"/>	<input type="checkbox"/>
		<input type="checkbox"/> 21	<input type="checkbox"/> 33
		<input type="checkbox"/>	<input type="checkbox"/>
		<input type="checkbox"/> 22	<input type="checkbox"/> 34

Note: Lines 1 through 8 only default on a telephone when the system is in Key mode.

Button Diagram

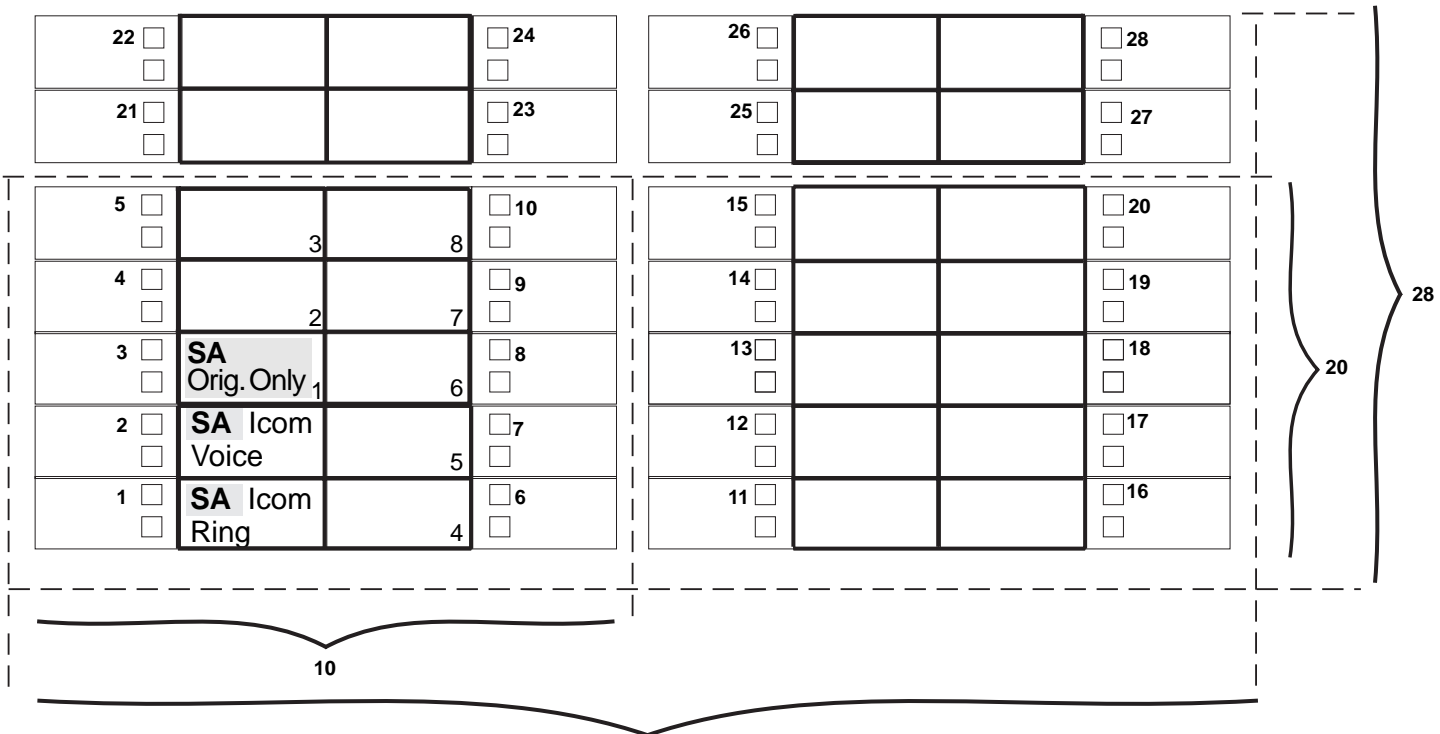

Note: Lines 1 through 8 only default on a telephone when the system is in Key mode.

<input type="checkbox"/> 13 <input type="checkbox"/>			<input type="checkbox"/> 16 <input type="checkbox"/>
<input type="checkbox"/> 12 <input type="checkbox"/>			<input type="checkbox"/> 15 <input type="checkbox"/>
<input type="checkbox"/> 11 <input type="checkbox"/>			<input type="checkbox"/> 14 <input type="checkbox"/>
<input type="checkbox"/> 5 <input type="checkbox"/>			<input type="checkbox"/> 10 <input type="checkbox"/>
<input type="checkbox"/> 4 <input type="checkbox"/>			<input type="checkbox"/> 9 <input type="checkbox"/>
<input type="checkbox"/> 3 <input type="checkbox"/>			<input type="checkbox"/> 8 <input type="checkbox"/>
<input type="checkbox"/> 2 <input type="checkbox"/>	Icom Voice		<input type="checkbox"/> 7 <input type="checkbox"/>
<input type="checkbox"/> 1 <input type="checkbox"/>	Icom Ring		<input type="checkbox"/> 6 <input type="checkbox"/>

Key Mode:

Up to 8 personal line
 buttons are assigned
 beginning at button 3.

Behind Switch Mode:
 One prime line button
 is assigned to button 3.

<input type="checkbox"/> 5 <input type="checkbox"/>			<input type="checkbox"/> 10 <input type="checkbox"/>
<input type="checkbox"/> 4 <input type="checkbox"/>			<input type="checkbox"/> 9 <input type="checkbox"/>
<input type="checkbox"/> 3 <input type="checkbox"/>			<input type="checkbox"/> 8 <input type="checkbox"/>
<input type="checkbox"/> 2 <input type="checkbox"/>	Icom Voice		<input type="checkbox"/> 7 <input type="checkbox"/>
<input type="checkbox"/> 1 <input type="checkbox"/>	Icom Ring		<input type="checkbox"/> 6 <input type="checkbox"/>

Behind Switch Mode:

One prime line is assigned
 to button 3

MLX Telephone

(Make a copy of this form for each telephone.)

Logical ID _____ Extension No. _____ Person or Location _____

Copied from Master Ext. No. _____

Wall Mount

Telephone Model

MLX-20L®*

MLX-28D®

MLX-16DP®

MLX-10D®

MLX-10DP®†

MLX-10®

MLX-5D®

MLX-5®

Adjuncts

Headset

Hearing-impaired handset

Noisy environment

Multi-Function Module (MFM) (Not supported on the MLX-5 and MLX-5D) Extension No. _____

FAX machine

Answering machine

Data terminal

Alert device, type _____

Other _____

Off Premises

Passageway

Personal Lines

Shared Extension No. _____

Ring

No Ring

Auto Line Selection

Centralized Programming Requirements**

Assign Service Observing Button

◆ Factory Setting

* The system capacity for Personal Directories is decreased by one whenever an MLX-20L telephone is connected to an MLX port.

† This telephone is the same as the MLX-10D except it has an adjunct plug in the back for connection to a PC when programming telephone features using the PassageWay™ Direct Connect Solution software application. This telephone is available with Release 2.1 and later.

** Refer to Form 11 to assign as a Service Observer.

Optional Features

Abbreviated Ring

Off

On ◆

Auto Callback

Off ◆

On

Call Waiting

Off ◆

On

Voice-Announced Calls

On ◆

Off

On Idle Only

Coverage Inside

Off

On ◆

Cover Ring Delay

Primary Cover Ring Delay

2 Rings ◆

_____rings (1-6)

Secondary Cover Ring Delay

2 Rings ◆

_____rings (1-6)

Group Coverage Ring Delay

3 Rings ◆

_____rings (1-9)

Computer Telephony Integrated Client PC

Yes

No ◆



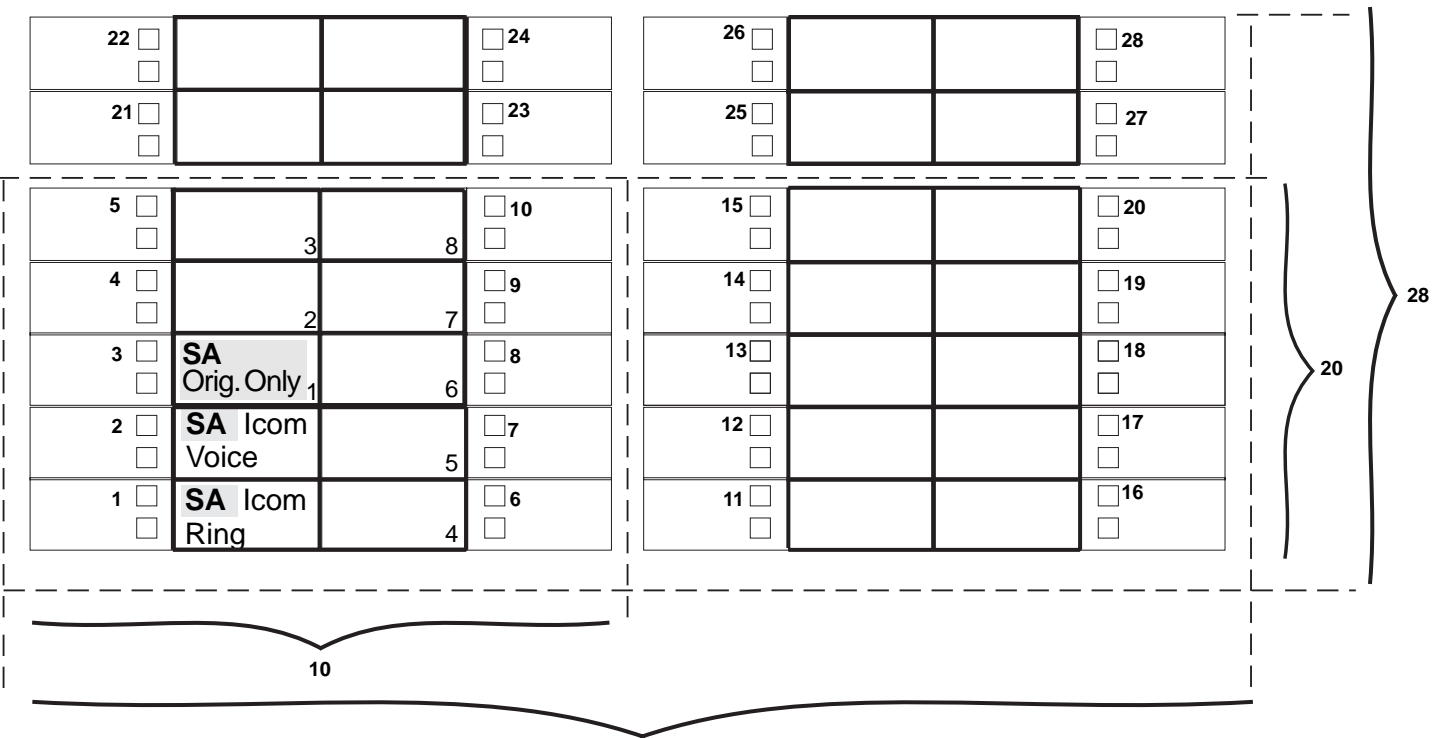





























Button Diagram
 See Master Extension



Note: Lines 1 through 8 only default on a telephone when the system is in Key mode.

Button Diagram

See Master Extension

 13 			 16 
 12 			 15 
 11 			 14 
 5 			 10 
 4 			 9 
 3 	SA Orig. Only		 8 
 2 	SA Icom Voice		 7 
 1 	SA Icom Ring		 6 

Button Diagram for MLX-16DP Telephone

MFM Adjunct: MLX Telephone

Extension No. _____ Person or Location _____

Connected to MLX extension No. _____

Copied from Master Extension No. _____

Adjuncts

- FAX machine
- Answering machine
 - Used as delay announcement device for calling groups
Ext. No. _____
- Data terminal
- Alert device, type _____
 - Used as Calls-in-Queue Alarm device for calling groups
Ext. No. _____
- Other _____

Button Diagram

- See Master Extension

Line 3	5	Line 8	10
Line 2	4	Line 7	9
Line 1 SA Orig. Only	3	Line 6	8
SA Icom Voice	2	Line 5	7
SA Icom Ring	1	Line 4	6

Note: Lines 1 through 8 only default on a telephone when the system is in Key mode.

Centralized Programming Requirements

- Disable Voice Announce – change button 2 assignment to System Access Originate Only and remove button 3 assignment
- Enable Ringing/Idle Line Preference
- Change Automatic Line Selection order to: (1) System Access Ring, (2) System Access Originate Only, (3) outside trunks assigned to buttons 3 through 10
- Set Ringing Option to No Ring for each personal line on which calls are **not** received

Auto Line Selection

Optional Features

Auto Callback

- Off ♦
- On

Call Waiting

- Off ♦
- On

Coverage Inside

- Off
- On ♦

Cover Ring Delay

Primary Cover Ring Delay

- 2 Rings ♦
- ___rings (1–6)

Secondary Cover Ring Delay

- 2 Rings ♦
- ___rings (1–6)

Group Coverage Ring Delay

- 3 Rings ♦
- ___rings (1–9)

♦ Factory Setting

Tip/Ring Equipment

(Make a copy of this form for each device.)

Logical ID _____ Extension No. _____ Person or Location _____

Type

- Single-line telephone
- Answering machine
 - Used as delay announcement device for calling groups
Ext. No. _____
- FAX machine
- PARTNER Doorphone (008 OPT or 016 ETR module)
- Other _____

Adjuncts

- Speakerphone
- Hearing-impaired handset
- Noisy environment
- Off Premises via OPRE

Auto Line Selection

Button Diagram

Line 3	5	Line 8	10
Line 2	4	Line 7	9
Line 1 SA Orig. Only	3	Line 6	8
SA Icom Ring	2	Line 5	7
SA Icom Ring	1	Line 4	6

Optional Features

Auto Callback

- Off ♦
- On

Call Waiting

- Off ♦
- On

Coverage Inside

- Off
- On ♦

HotLine

- Off ♦
- On
Tel. No. or Ext. No. _____

Cover Ring Delay

Primary Cover Ring Delay

- 2 Rings ♦
- ___rings (1-6)

Secondary Cover Ring Delay

- 2 Rings ♦
- ___rings (1-6)

Group Coverage Ring Delay

- 3 Rings ♦
- ___rings (1-9)

Centralized Programming Requirements

- Remove all but one SA button to disable features such as Transfer and Conference.

♦ Factory Setting

Form 4g (Continued)

ETR-34D Button Diagram

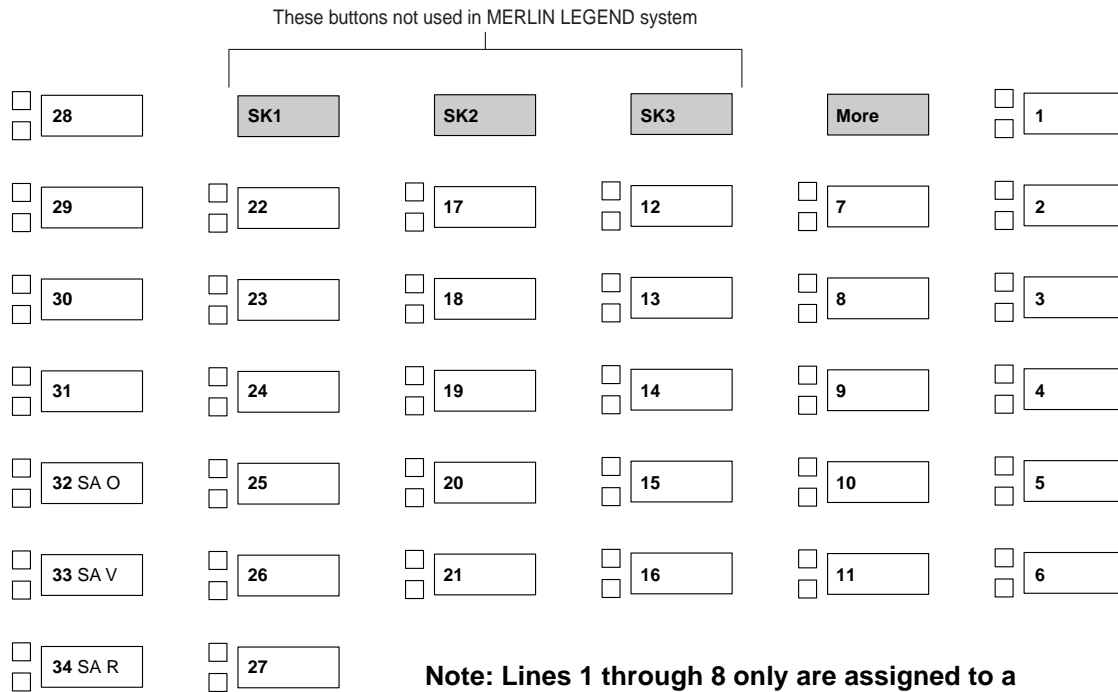

ETR-18/18D Button Diagram

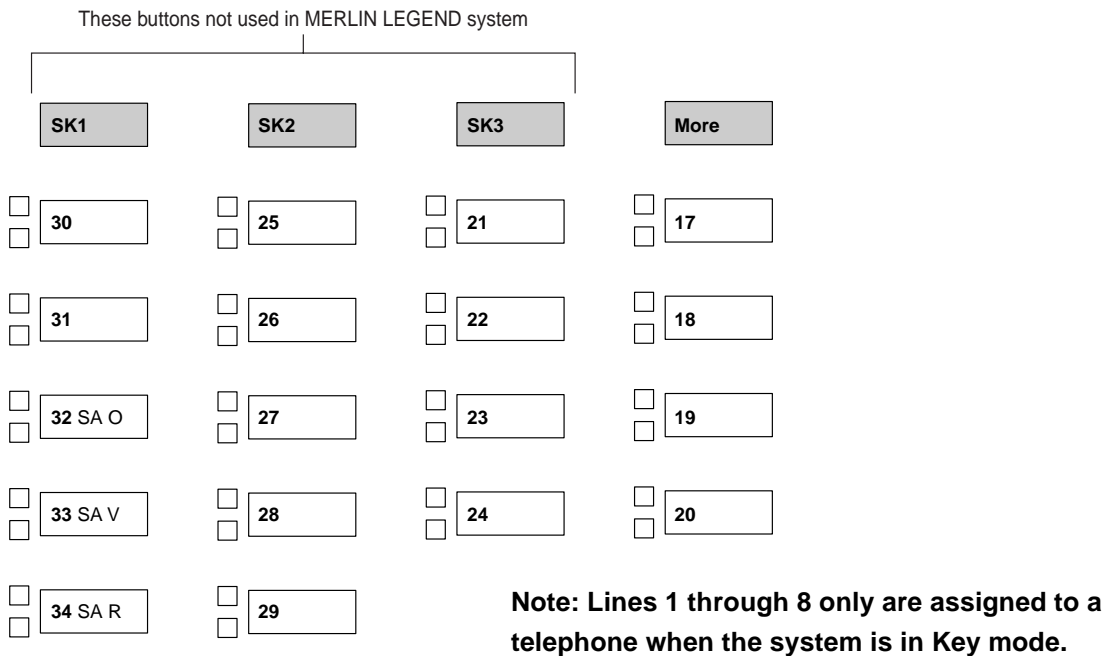

ETR-6 Button Diagram

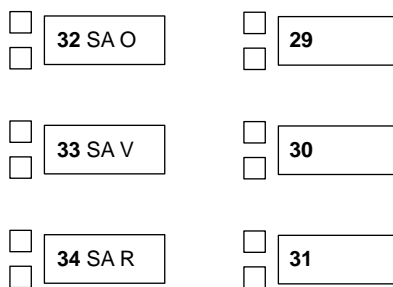

Form 4h

ETR Telephone

(Make a copy of this form for each telephone.)

Logical ID _____ Extension No. _____ Person or Location _____

Copied from Master Ext. No. _____

Telephone Model

- ETR-34D®
- ETR-18D®
- ETR-18®
- ETR-6®

Adjuncts

- Off Premises via OPRE

Personal Lines

Shared Extension No. _____

- Ring
- No Ring

Auto Line Selection

Optional Features

Abbreviated Ring

- Off
- On ♦

Auto Callback

- Off ♦
- On

Call Waiting

- Off ♦
- On

Coverage Inside

- Off
- On ♦

Computer Telephony Integrated Client PC

- Yes
- No♦

Cover Ring Delay

Primary Cover Ring Delay

- 2 Rings ♦
- ___rings (1-6)

Secondary Cover Ring Delay

- 2 Rings ♦
- ___rings (1-6)

Group Coverage Ring Delay

- 3 Rings ♦
- ___rings (1-9)

♦ Factory Setting

Form 4h (Continued)

ETR-34D Button Diagram

See Master Extension

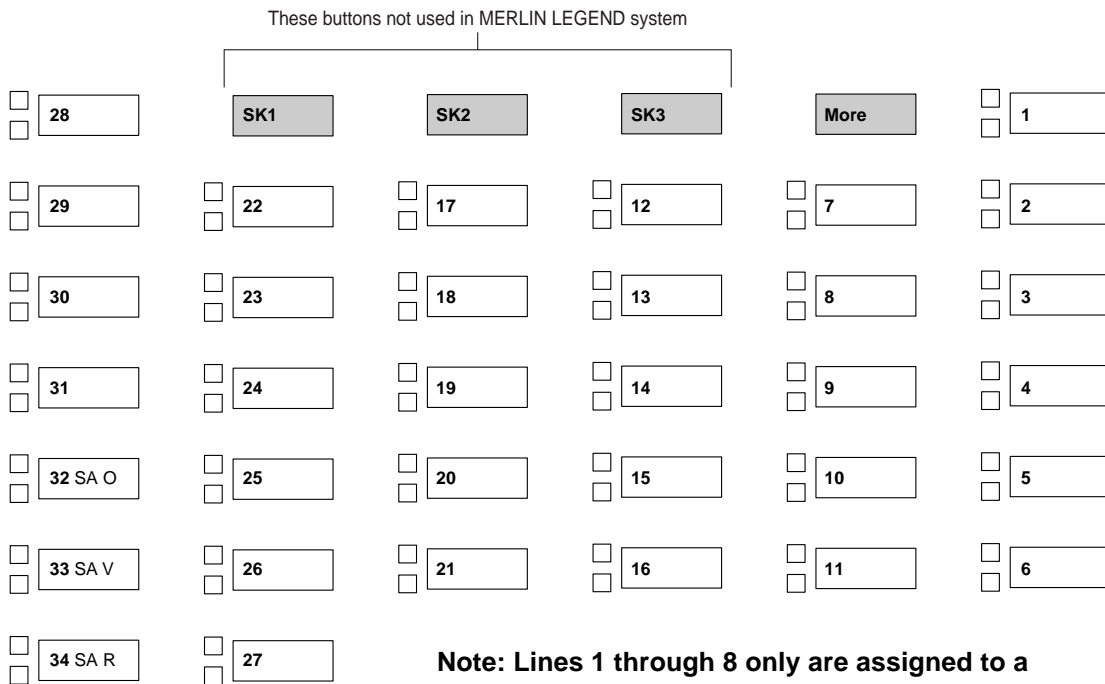

ETR-18/18D Button Diagram

See Master Extension

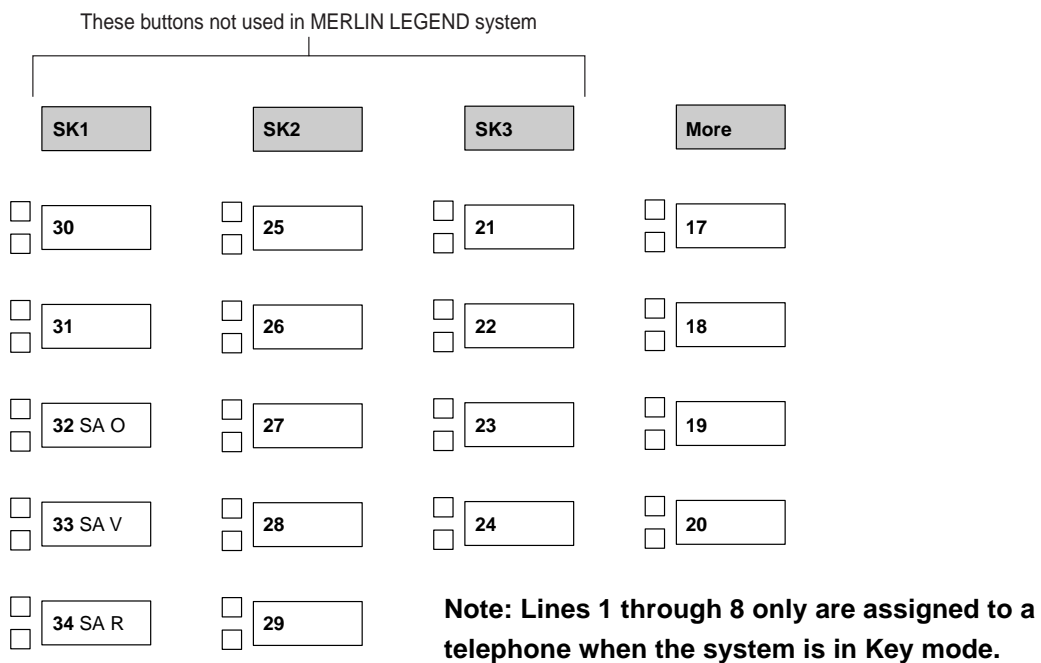

Form 4h (Continued)

ETR-6 Button Diagram

See Master Extension

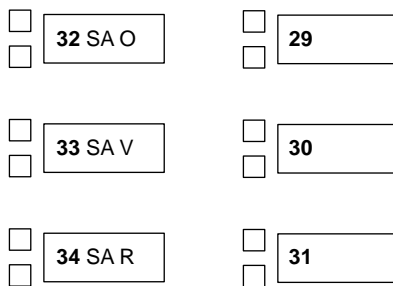

Form 4i (Continued)

MLS-34D Button Diagram

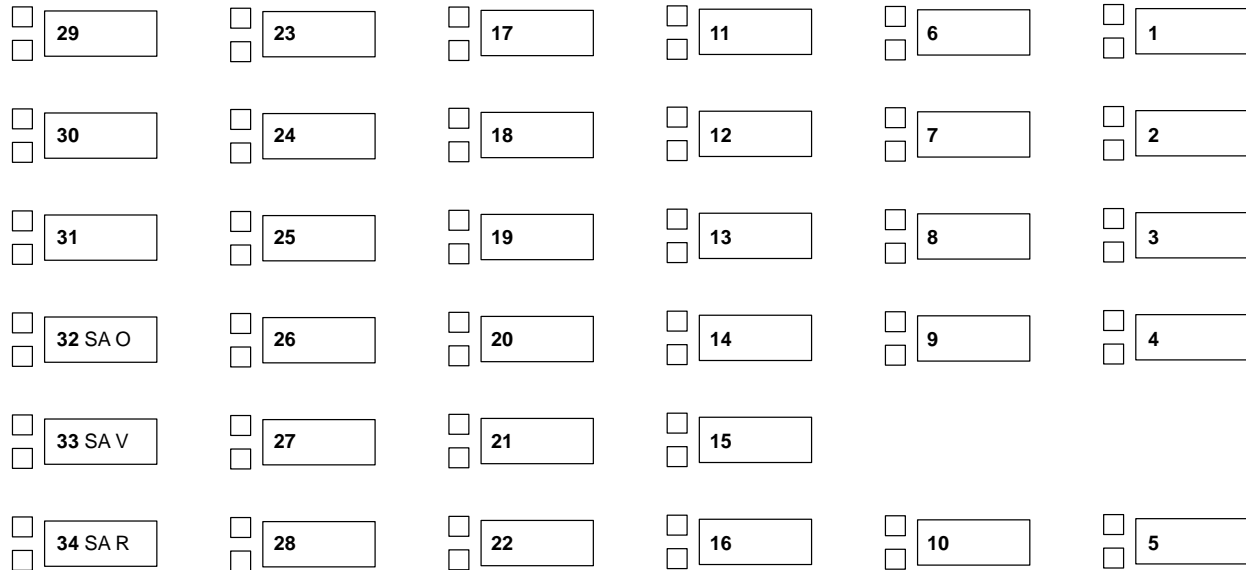

Note: Lines 1 through 8 only are assigned to a telephone when the system is in Key mode.

MLS-18D Button Diagram

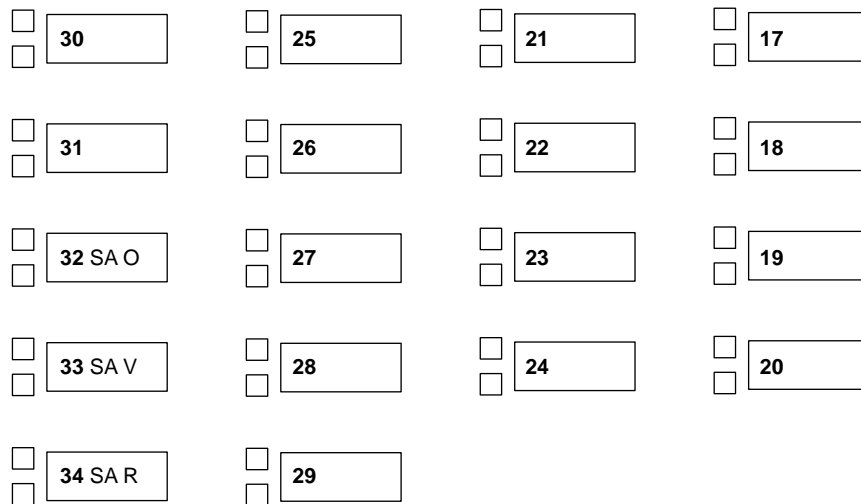

Note: Lines 1 through 8 only are assigned to a telephone when the system is in Key mode.

MLS-12/12D, TransTalk, and Business Cordless 905 Button Diagram

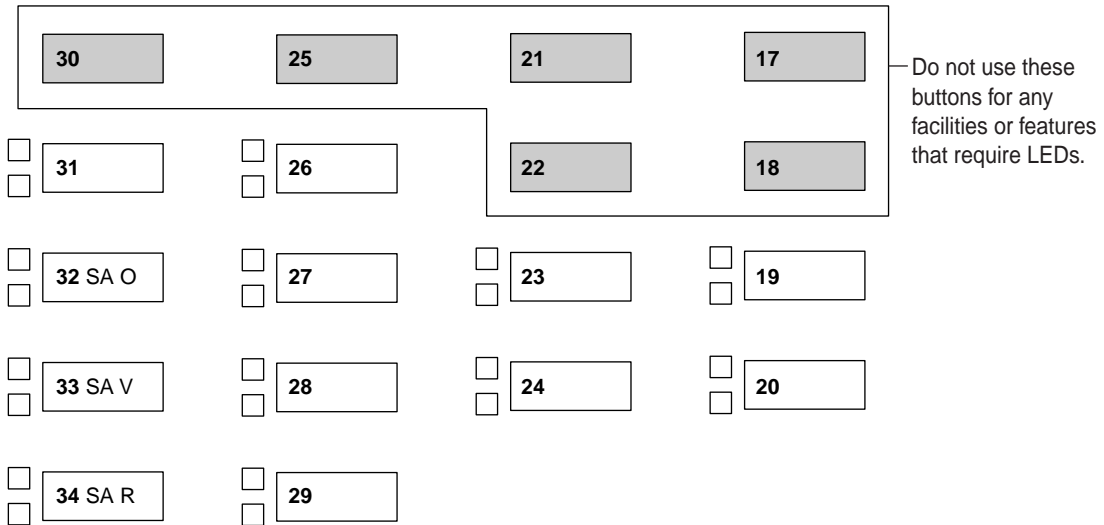

Note: Lines 1 through 8 only are assigned to a telephone when the system is in Key mode.

MLS-6 Button Diagram

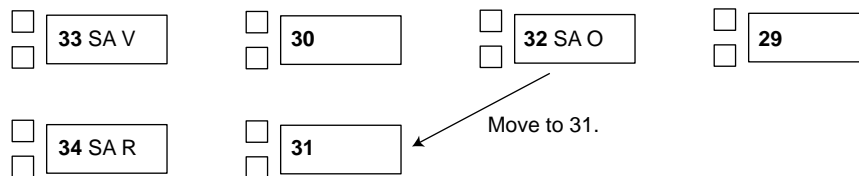

Form 4j

MLS Telephone*

(Make a copy of this form for each telephone.)

Logical ID _____ Extension No. _____ Person or Location _____

Copied from Master Ext. No. _____

Telephone Model

- MLS-34D®
- MLS-18D®
- MLS-12D®
- MLS-12
- MLS-6®
- TransTalk®
- Business Cordless 905®

Adjuncts

- Off Premises via OPRE

Personal Lines

Shared Extension No. _____

- Ring
- No Ring

Auto Line Selection

Optional Features

Abbreviated Ring

- Off
- On ♦

Auto Callback

- Off ♦
- On

Call Waiting

- Off ♦
- On

Coverage Inside

- Off
- On ♦

Computer Telephony Integrated Client PC

- Yes
- No♦

Cover Ring Delay

Primary Cover Ring Delay

- 2 Rings ♦
- ___rings (1-6)

Secondary Cover Ring Delay

- 2 Rings ♦
- ___rings (1-6)

Group Coverage Ring Delay

- 3 Rings ♦
- ___rings (1-9)

♦ Factory Setting
* No longer available

Form 4j (Continued)

MLS-34D Button Diagram

See Master Extension

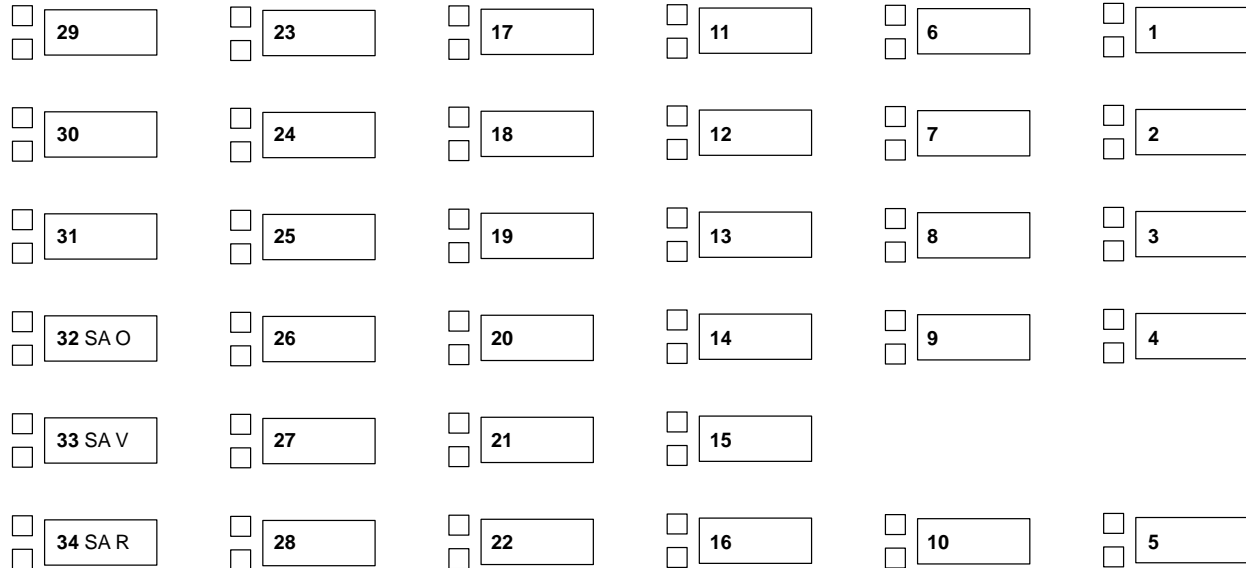

Note: Lines 1 through 8 only are assigned to a telephone when the system is in Key mode.

MLS-18D Button Diagram

See Master Extension

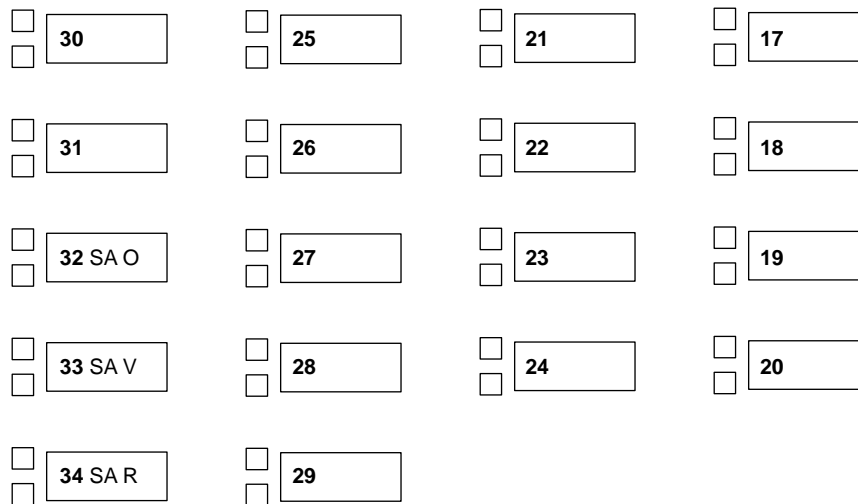

Note: Lines 1 through 8 only are assigned to a telephone when the system is in Key mode.

Form 4j (Continued)

MLS-12/12D, TransTalk, and Business Cordless 905 Button Diagram

See Master Extension

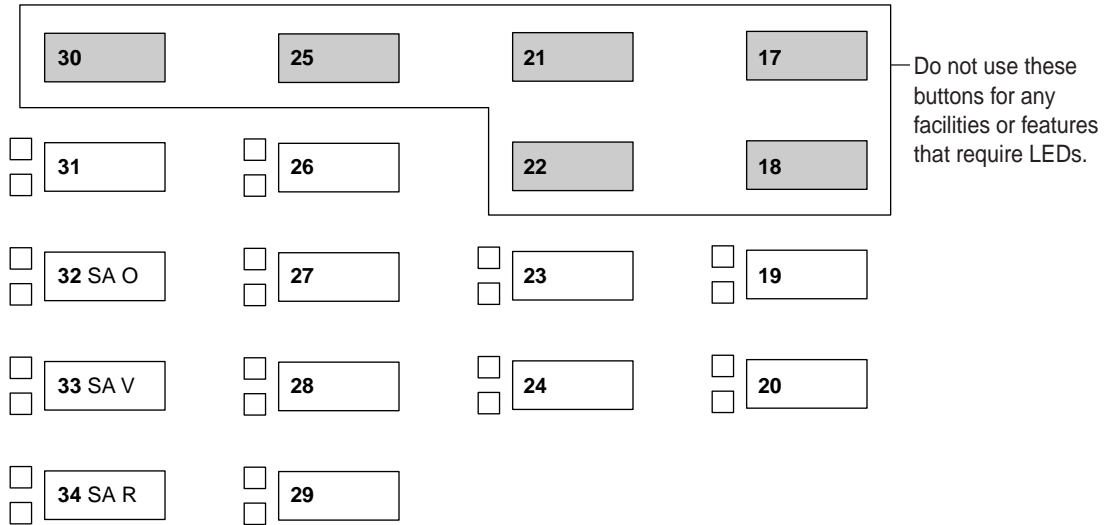

Note: Lines 1 through 8 only are assigned to a telephone when the system is in Key mode.

MLS-6 Button Diagram

See Master Extension

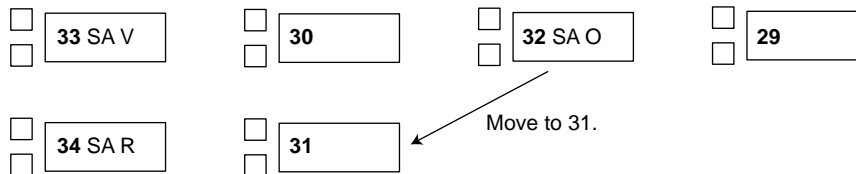

Direct-Line Console (DLC): Analog

(Make a copy of this form for each telephone.)

Logical ID _____ Extension No. _____ Person or Location _____

Copied from Master Ext. No. _____

Extension Jack Pair

- Voice Announce to Busy (voice/voice)
- Simultaneous Voice and Data (voice/data)

Even-numbered jack

Logical ID _____ Ext. No. _____

Console Model

- MERLIN II System Display Console
- BIS-34D
- BIS-34
- BIS-22

Adjuncts

- General Purpose Adapter
 - FAX machine
 - Answering machine
 - Data terminal
 - Other _____
- Supplemental Station Alert Adapter
Alert Device type _____
- Headset
- Headset adapter
- Hearing-impaired handset
- Noisy environment
- CTI PC (DLC must be a BIS set)
- Other _____

Personal Lines

Auto Line Selection

Optional Features

Abbreviated Ring

- Off
- On ♦

Auto Callback

- Off ♦
- On

Call Waiting

- Off ♦
- On

Voice-Announced Calls

- On ♦
- Off

Coverage Inside

- Off
- On ♦

Cover Ring Delay

Primary Cover Ring Delay

- 2 Rings ♦
- ____rings (1-6)

Secondary Cover Ring Delay

- 2 Rings ♦
- ____rings (1-6)

Group Coverage Ring Delay

- 3 Rings ♦
- ____rings (1-9)

Button Diagram

See Master Extension

DISPLAY CONSOLE WITH DSS							
34 BUTTON							
22 BUTTON							
<input type="checkbox"/>	<input type="checkbox"/>	<input type="checkbox"/>	<input type="checkbox"/>	<input type="checkbox"/>	<input type="checkbox"/>	<input type="checkbox"/>	<input type="checkbox"/>
5	10	11	23	10	20	30	40
<input type="checkbox"/>	<input type="checkbox"/>	<input type="checkbox"/>	<input type="checkbox"/>	<input type="checkbox"/>	<input type="checkbox"/>	<input type="checkbox"/>	<input type="checkbox"/>
4	9	12	24	11	21	31	41
<input type="checkbox"/>	<input type="checkbox"/>	<input type="checkbox"/>	<input type="checkbox"/>	<input type="checkbox"/>	<input type="checkbox"/>	<input type="checkbox"/>	<input type="checkbox"/>
3	8	13	25	12	22	32	42
<input type="checkbox"/> SA Icom	<input type="checkbox"/>	<input type="checkbox"/>	<input type="checkbox"/>	<input type="checkbox"/>	<input type="checkbox"/>	<input type="checkbox"/>	<input type="checkbox"/>
<input type="checkbox"/> Voice	2	7	14	26	13	23	33
<input type="checkbox"/> SA Icom	<input type="checkbox"/>	<input type="checkbox"/>	<input type="checkbox"/>	<input type="checkbox"/>	<input type="checkbox"/>	<input type="checkbox"/>	<input type="checkbox"/>
<input type="checkbox"/> Ring	1	6	15	27	14	24	34
		<input type="checkbox"/>	<input type="checkbox"/>	<input type="checkbox"/>	<input type="checkbox"/>	<input type="checkbox"/>	<input type="checkbox"/>
		16	28	15	25	35	45
		<input type="checkbox"/>	<input type="checkbox"/>	<input type="checkbox"/>	<input type="checkbox"/>	<input type="checkbox"/>	<input type="checkbox"/>
		17	29	16	26	36	46
		<input type="checkbox"/>	<input type="checkbox"/>	<input type="checkbox"/>	<input type="checkbox"/>	<input type="checkbox"/>	<input type="checkbox"/>
		18	30	17	27	37	47
		<input type="checkbox"/>	<input type="checkbox"/>	<input type="checkbox"/>	<input type="checkbox"/>	<input type="checkbox"/>	<input type="checkbox"/>
		19	31	18	28	38	48
		<input type="checkbox"/>	<input type="checkbox"/>	<input type="checkbox"/>	<input type="checkbox"/>	<input type="checkbox"/>	<input type="checkbox"/>
		20	32	19	29	39	49
		<input type="checkbox"/>	<input type="checkbox"/> Alarm	<input type="checkbox"/>	<input type="checkbox"/>	<input type="checkbox"/>	<input type="checkbox"/>
		21	33	<input type="checkbox"/> Trnsfr	<input type="checkbox"/> Recall	<input type="checkbox"/> Conf	<input type="checkbox"/> Drop
		<input type="checkbox"/>	<input type="checkbox"/> Night Serv	<input type="checkbox"/>	<input type="checkbox"/>	<input type="checkbox"/>	<input type="checkbox"/>
		22	34	<input type="checkbox"/> Shift 1	<input type="checkbox"/> Shift 2	<input type="checkbox"/> Shift 3	<input type="checkbox"/> Msg Stat
		<input type="checkbox"/>	<input type="checkbox"/> Send/Remove Msg	<input type="checkbox"/>	<input type="checkbox"/>	<input type="checkbox"/>	<input type="checkbox"/>

Note: Alarm, Night Service, and Send/Remove Msg will be replaced with Lines 30, 31, and 32 if the system has that many lines.

Assignment of outside trunks to console buttons begins with button number 3.

Direct-Line Console (DLC): Digital

(Make a copy of this form for each console.)

Logical ID _____ Extension No. _____ Person or Location _____

Copied from Master Ext. No. _____

Console Model

MLX-20L™

MLX-28D™

Adjuncts

Direct Station Selector
Number (1 or 2) _____

Multi-Function Module (MFM) Extension No.

FAX machine

Answering machine

Data terminal

Alert device
type _____

Other _____

Headset

Hearing-impaired handset

Noisy environment

CTIPC

Personal Lines

Auto Line Selection

Optional Features

Abbreviated Ring

Off

On ♦

Auto Callback

Off ♦

On

Call Waiting

Off ♦

On

Voice-Announced Calls

On ♦

Off

Coverage Inside

Off

On ♦

Cover Ring Delay

Primary Cover Ring Delay

2 Rings ♦

____rings (1-6)

Secondary Cover Ring Delay

2 Rings ♦

____rings (1-6)

Group Coverage Ring Delay

3 Rings ♦

____rings (1-9)

♦ Factory Setting

Button Diagram

☐ See Master Extension

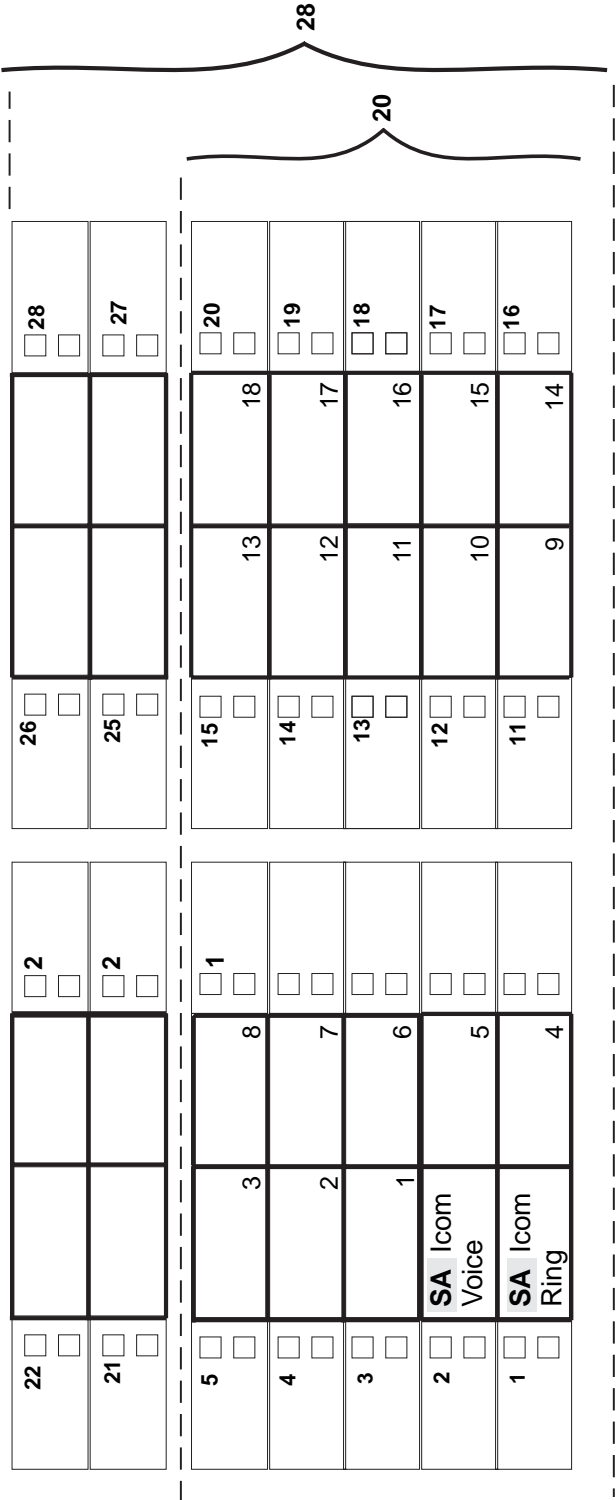

Assignment of outside trunks to console buttons begins with number 3.

MFMAdjunct: DLC

Extension No. _____ Person or Location _____

Connected to MLX extension No. _____

Copied from Master Extension No. _____

Adjuncts

- FAX machine
- Answering machine
 - Used as delay announcement device for calling groups
Ext. No. _____
- Data terminal
- Alert device, type _____
 - Use as Calls-in-Queue Alarm device for calling groups
Ext. No. _____
- Other _____

Button Diagram

- See Master Extnsions

Line 3	Line 8
Line 2	Line 7
Line 1 SA Orig. Only	Line 6
SA Icom Voice	Line 5
SA Icom Ring	Line 4

Note: Lines 1 through 8 only default on a telephone when the system is in Key mode.

Centralized Programming Requirements

- Disable Voice Announce – change button 2 assignment to System Access Originate Only and remove button 3 assignment
- Enable Ringing/Idle Line Preference
- Change Automatic Line Selection order to: (1) System Access Ring, (2) System Access Originate Only, (3) outside trunks assigned to buttons 3 through 10
- Set Ringing Option to No Ring for each personal line on which calls are **not** received

Auto Line Selection

Optional Features

Auto Callback

- Off ♦
- On

Call Waiting

- Off ♦
- On

Coverage Inside

- Off
- On ♦

Cover Ring Delay

Primary Cover Ring Delay

- 2 Rings ♦
- ___rings (1–6)

Secondary Cover Ring Delay

- 2 Rings ♦
- ___rings (1–6)

Group Coverage Ring Delay

- 3 Rings ♦
- ___rings (1–9)

♦ Factory Setting

Queued Call Console (QCC)*

(Make a copy of this form for each console.)

Logical ID _____ Extension No. _____ Person or Location _____

Adjuncts

- Direct Station Selector
- Number (1 or 2) _____
- Headset
- Hearing-impaired handset
- Noisy environment

Message Center Operator

- No
- Yes

Button Diagram

5 <input type="checkbox"/> <input type="checkbox"/>	G CALL 5VA	H POSITION BUSY	<input type="checkbox"/> 10 <input type="checkbox"/>	15 <input type="checkbox"/> <input type="checkbox"/>	I ALARM	J FORCED RELEASE	<input type="checkbox"/> 20 <input type="checkbox"/>
4 <input type="checkbox"/> <input type="checkbox"/>	K CALL 4	L SEND/REMOVE MSG	<input type="checkbox"/> 9 <input type="checkbox"/>	14 <input type="checkbox"/> <input type="checkbox"/>	M NIGHT SERVICE	N POOL STATUS	<input type="checkbox"/> 19 <input type="checkbox"/>
3 <input type="checkbox"/> <input type="checkbox"/>	O CALL 3	P HEADSET MUTE	<input type="checkbox"/> 8 <input type="checkbox"/>	13 <input type="checkbox"/> <input type="checkbox"/>	Q HEADSET STATUS	R HEADSET AUTO ANSWER	<input type="checkbox"/> 18 <input type="checkbox"/>
2 <input type="checkbox"/> <input type="checkbox"/>	S CALL 2	T SOURCE	<input type="checkbox"/> 7 <input type="checkbox"/>	12 <input type="checkbox"/> <input type="checkbox"/>	U DESTINATION	V JOIN	<input type="checkbox"/> 17 <input type="checkbox"/>
1 <input type="checkbox"/> <input type="checkbox"/>	W CALL 1	X START	<input type="checkbox"/> 6 <input type="checkbox"/>	11 <input type="checkbox"/> <input type="checkbox"/>	Y RELEASE	Z CANCEL	<input type="checkbox"/> 16 <input type="checkbox"/>

* Hybrid/PBX mode only.

Optional Operator Features

Direct-Line Console

Operator Hold Timer

- 60 seconds ♦
- _____ seconds (10–255)

DLC Automatic Hold

- Disable ♦
- Enable

Queued Call Console*

Hold Return

- Remain on hold ♦
- Return to queue

Message Center

- No
- Yes, Operator Extension No. _____

Automatic Hold or Release

- Automatic Release ♦
- Automatic Hold

Extended Call Completion

- Automatic completion ♦
- Manual completion

Calls-in-Queue Alert

- Disable ♦
- Enable, Operator Extension No(s).

Return Ring

- 4 rings ♦
- _____ rings (1–15)

Queue Over Threshold

- 0 calls ♦ (operators not notified when calls are in queue)
- _____ calls (1–99)

Position Busy Backup

- No ♦
- Yes, Extension no. of calling group backup _____

Elevate Priority

- 0 seconds ♦ (calls are not automatically reprioritized)
- _____ seconds (5–30)

Operator Hold Timer

- 60 seconds ♦
- _____ seconds (10–255)

Voice Announce

- Disable ♦
- Enable

Direct Station Selector

Page Buttons

Page Button	1	2	3
Beginning extension for range			

*Enter first extension number for range of 50 (1 DSS) or 100 (2 DSSs) extensions for each **Page** button.*

Call Park Codes (See Form 2d)

Factory-Set Extension No.	Renumber to	Factory-Set Extension No.	Renumber to
881		885	
882		886	
883		887	
884		888	

♦ *Factory Setting*

* *Hybrid/PBX mode only*

Call Types*

Call Types	QCC Operator to Receive Calls	QCC Queue Priority Level (4◆)
Dial 0		
Call Follow/Forward	N/A	
Unassigned DID		
Listed Directory Number		
QCC Extension	N/A	
Returning		

Group Coverage Calls

Group No.	QCC Operator to Receive Calls	QCC Queue Priority Level (4◆)	Group No.	QCC Operator to Receive Calls	QCC Queue Priority Level (4◆)
1			16		
2			17		
3			18		
4			19		
5			20		
6			21		
7			22		
8			23		
9			24		
10			25		
11			26		
12			27		
13			28		
14			29		
15			30		

◆ Factory Setting
 * Hybrid/PBX mode only

Principal User of Personal Line

Factory-Set Trunk No.	Extension No.	Factory-Set Trunk No.	Extension No.	Factory-Set Trunk No.	Extension No.	Factory-Set Trunk No.	Extension No.
801		821		841		861	
802		822		842		862	
803		823		843		863	
804		824		844		864	
805		825		845		865	
806		826		846		866	
807		827		847		867	
808		828		848		868	
809		829		849		869	
810		830		850		870	
811		831		851		871	
812		832		852		872	
813		833		853		873	
814		834		854		874	
815		835		855		875	
816		836		856		876	
817		837		857		877	
818		838		858		878	
819		839		859		879	
820		840		860		880	

Note: Lines must be assigned to the principal user's extension before the principal users can be programmed.
 See Form 2c, page1 for telephone numbers and extension numbers assigned to trunks.

Message-Waiting Receivers

System Notification Threshold (0-30 seconds) _____
(factory setting is 10 seconds)

	Fax Machine Extension No.	Receivers			
		Ext. No.	Ext. No.	Ext. No.	Ext. No.
1					
2					
3					
4					
5					
6					
7					
8					
9					
10					
11					
12					
13					
14					
15					
16					

List 4 _____

0									
1									
2									
3									
4									
5									
6									
7									
8									
9									

List 5 _____

0									
1									
2									
3									
4									
5									
6									
7									
8									
9									

List 6 _____

0									
1									
2									
3									
4									
5									
6									
7									
8									
9									

List 7 _____

0									
1									
2									
3									
4									
5									
6									
7									
8									
9									

Allow to Ext. Nos.

Allow to Ext. Nos.

Allow to Ext. Nos.

Allow to Ext. Nos.

Call Pickup Groups

Maximum: 30 groups. (Make additional copies if more than 8 groups are assigned.)

Group Number _____		
Group ID _____		
	Ext. No.	Person or Location
1		
2		
3		
4		
5		
6		
7		
8		
9		
10		
11		
12		
13		
14		
15		

Group Number _____		
Group ID _____		
	Ext. No.	Person or Location
1		
2		
3		
4		
5		
6		
7		
8		
9		
10		
11		
12		
13		
14		
15		

Group Number _____		
Group ID _____		
	Ext. No.	Person or Location
1		
2		
3		
4		
5		
6		
7		
8		
9		
10		
11		
12		
13		
14		
15		

Group Number _____		
Group ID _____		
	Ext. No.	Person or Location
1		
2		
3		
4		
5		
6		
7		
8		
9		
10		
11		
12		
13		
14		
15		

Form 7a (Continued)

Group Number _____		
Group ID _____		
	Ext. No.	Person or Location
1		
2		
3		
4		
5		
6		
7		
8		
9		
10		
11		
12		
13		
14		
15		

Group Number _____		
Group ID _____		
	Ext. No.	Person or Location
1		
2		
3		
4		
5		
6		
7		
8		
9		
10		
11		
12		
13		
14		
15		

Group Number _____		
Group ID _____		
	Ext. No.	Person or Location
1		
2		
3		
4		
5		
6		
7		
8		
9		
10		
11		
12		
13		
14		
15		

Group Number _____		
Group ID _____		
	Ext. No.	Person or Location
1		
2		
3		
4		
5		
6		
7		
8		
9		
10		
11		
12		
13		
14		
15		

Group Paging

(See Form 2d)

Group No. 1 Group ID _____		
Factory-Set Ext. No. 793 Renumber to _____		
	Ext. No.	Person or Location
1		
2		
3		
4		
5		
6		
7		
8		
9		
10		

Group No. 2 Group ID _____		
Factory-Set Ext. No. 794 Renumber to _____		
	Ext. No.	Person or Location
1		
2		
3		
4		
5		
6		
7		
8		
9		
10		

Group No. 3 Group ID _____		
Factory-Set Ext. No. 795 Renumber to _____		
	Ext. No.	Person or Location
1		
2		
3		
4		
5		
6		
7		
8		
9		
10		

Group No. 4 Group ID _____		
Factory-Set Ext. No. 796 Renumber to _____		
	Ext. No.	Person or Location
1		
2		
3		
4		
5		
6		
7		
8		
9		
10		

Group No. 5 Group ID _____ Factory-Set Ext. No. 797 Renumber to _____		
	Ext. No.	Person or Location
1		
2		
3		
4		
5		
6		
7		
8		
9		
10		

Group No. 6 Group ID _____ Factory-Set Ext. No. 798 Renumber to _____		
	Ext. No.	Person or Location
1		
2		
3		
4		
5		
6		
7		
8		
9		
10		

Group No. 7 Page All Factory-Set Ext. No. 799 Renumber to _____

Group Number _____

Group ID _____

Ext. No. _____

Calling Group Options*

Hunt Type

- Circular ♦
- Linear
- Most-Idle

Primary Delay Announcements

- No ♦
- Yes, Extension No. _____

Secondary Delay Announcement

- No ♦
- Yes, Extension No. _____
Delay Interval _____ (0♦-900 sec.)
 - Disabled ♦
 - Enabled

Message-Waiting Receiver

- No ♦
- Yes, Extension No. _____

First Calls-in-Queue Alarm Threshold

- 1 call ♦
- _____ calls (2-99)

Second Calls-in-Queue Alarm Threshold

- 1 call ♦
- _____ calls (2-99)

Third Calls-in-Queue Alarm Threshold

- 1 call ♦
- _____ calls (2-99)

External Alert for Calls-in-Queue Alarm

- No ♦
- Yes, Extension No. _____

Overflow Coverage

- No ♦
- Yes, Calling Group No. _____
- Yes, QCC LDN (queue) Extension No. _____

Overflow Threshold

- 1 call ♦
- _____ calls (2-99)

Overflow Threshold Time

- 0 seconds ♦
- _____ seconds (1-900)

Group Type

- Auto Login
- Auto Logout ♦
- Integrated VMI†
- Generic VMI†

Prompt-Based Overflow

- Disabled ♦
- Enabled

Queue Control

- 99 calls ♦
- _____ calls (0-98)

Priority Call Queuing

- No ♦
- Yes
 - Home Group Priority Level _____
(1-32; 16 is the factory setting.)
 - Support Group Extension No. _____
(Support Group Priority Level) _____

* If the system has AUDIX Voice Power/FAX Attendant System, you do not need to fill in this information. Settings will be automatically set by Integrated Administration to defaults assumed by the AUDIX Voice Power system (and not necessarily those listed on this form). Changing the assumed defaults could affect how the AUDIX Voice Power system works. If you change them, DO SO WITH CAUTION, and record the settings on this form. For more information, see the AUDIX Voice Power documentation.

† Any port programmed as a VMI port is, by default, restricted from making outgoing calls.

System Features

Transfer Options**

Return Time Interval†

- 4 rings ♦
- 0 rings
- _____ rings (1–9)

One-Touch Call Handling

- One-Touch Transfer ♦
 - Manual Completion
 - Automatic Completion ♦
- One-Touch-Hold

Transfer Audible

- Music On Hold ♦
- Ringback

Type of Transfer

- Voice button
- Ring button ♦

Camp-On Return Time

- 90 seconds ♦
- _____ seconds (30–300)

Call Park Return Time

- 180 seconds ♦
- _____ seconds (30–300)

Automatic Callback Interval

- 3 rings ♦
- _____ rings (1–6)

Extension Status

- Hotel
 - Assign to operator positions
 - _____
 - _____
- Group Calling/CMS ♦

SMDR Options

Call Report Format

- Basic ♦
- ISDN

Calls Reported (non-UDP)

- Incoming and outgoing ♦
- Outgoing only

Talk Time

- Enabled
- Disabled ♦

Inside Dial Tone

- Inside ♦
- Outside

Reminder Service Cancel

- No
- Yes, _____ time of day

Calls to Unassigned Extensions

- QCCQueue _____ §
- Extension ♦, No. _____ (default is the primary operator extension)
- Calling Group, Extension No. _____

Recall Timer

- 350 ms
- 450 ms ♦
- 650 ms
- 1 sec

Rotary

- Delay ♦
- No Delay

Call Length‡

- 40 seconds ♦
- _____ seconds (0–255)

Calls Reported (UDP)

- Incoming and outgoing
- None ♦

Note: If you use equipment that rebroadcasts music or other copyrighted material, you may be required to obtain a copyright license from, and pay license fees to, a third party such as the American Society of Composers, Artists, and Producers (ASCAP) or Broadcast Music Incorporated (BMI). Or you can purchase a Magic-on-Hold system, which does not require you to obtain such a license, from Lucent Technologies or an authorized representative.

♦ Factory Setting

* Beginning with Release 2.1; calls received on personal lines with Do Not Disturb on will go immediately to Coverage instead of waiting for the Cover Delay Interval.

† If the system has AUDIX Voice Power/FAX Attendant System, Integrated Administration will automatically set the Return Time Interval to "6."

‡ For systems where the majority of lines are PRI, the SMDR Call Length should be one second.

** Transfer features (and any feature that requires more than one SA button) can be disabled on single-line telephones by removing all but one SA button via Centralized Programming.

§ Hybrid/PBX mode only

Night Service: Options

Day	Start Time*	Stop Time*
Sunday (0)		
Monday (1)		
Tuesday (2)		
Wednesday (3)		
Thursday (4)		
Friday (5)		
Saturday (6)		

* Hours and minutes in 24-hour (military) time

Note: Start time is the END of your business day.
Stop time is the BEGINNING of your business day.

Coverage Control

- Enable
- Disable ◆

◆ Factory Setting

Label Form: Posted Message

Message No.	Default Label	Revised Message (16 characters maximum)
1	DO NOT DISTURB	(Cannot be changed)
2	OUT TO LUNCH	_ _ _ _ _ _ _ _ _ _ _ _ _ _ _
3	AT HOME	_ _ _ _ _ _ _ _ _ _ _ _ _ _ _
4	OUT SICK	_ _ _ _ _ _ _ _ _ _ _ _ _ _ _
5	IN A MEETING	_ _ _ _ _ _ _ _ _ _ _ _ _ _ _
6	IN CONFERENCE	_ _ _ _ _ _ _ _ _ _ _ _ _ _ _
7	WITH A CLIENT	_ _ _ _ _ _ _ _ _ _ _ _ _ _ _
8	WITH A CUSTOMER	_ _ _ _ _ _ _ _ _ _ _ _ _ _ _
9	AWAY FROM DESK	_ _ _ _ _ _ _ _ _ _ _ _ _ _ _
10	OUT ALL DAY	_ _ _ _ _ _ _ _ _ _ _ _ _ _ _
11	CUSTM MSG11	_ _ _ _ _ _ _ _ _ _ _ _ _ _ _
12	CUSTM MSG12	_ _ _ _ _ _ _ _ _ _ _ _ _ _ _
13	CUSTM MSG13	_ _ _ _ _ _ _ _ _ _ _ _ _ _ _
14	CUSTM MSG14	_ _ _ _ _ _ _ _ _ _ _ _ _ _ _
15	CUSTM MSG15	_ _ _ _ _ _ _ _ _ _ _ _ _ _ _
16	CUSTM MSG16	_ _ _ _ _ _ _ _ _ _ _ _ _ _ _
17	CUSTM MSG17	_ _ _ _ _ _ _ _ _ _ _ _ _ _ _
18	CUSTM MSG18	_ _ _ _ _ _ _ _ _ _ _ _ _ _ _
19	CUSTM MSG19	_ _ _ _ _ _ _ _ _ _ _ _ _ _ _
20	CUSTM MSG20	_ _ _ _ _ _ _ _ _ _ _ _ _ _ _

System Speed Dial

Dial Code	Name (11 characters maximum)	Telephone Number (40 digits maximum)	Display	
			Yes ♦	No*
#600				
#601				
#602				
#603				
#604				
#605				
#606				
#607				
#608				
#609				
#610				
#611				
#612				
#613				
#614				
#615				
#616				
#617				
#618				
#619				
#620				
#621				

♦ Factory Setting
 * If you select "No" display, this indicates a Marked System Speed Dial number which can override calling restrictions.

Dial Code	Name (11 characters maximum)	Telephone Number (40 digits maximum)	Display	
			Yes ♦	No*
#622				
#623				
#624				
#625				
#626				
#627				
#628				
#629				
#630				
#631				
#632				
#633				
#634				
#635				
#636				
#637				
#638				
#639				
#640				
#641				
#642				
#643				

♦ Factory Setting
 * If you select "No" display, this indicates a Marked System Speed Dial number which can override calling restrictions.

System Speed Dial

Dial Code	Name (11 characters maximum)	Telephone Number (40 digits maximum)	Display	
			Yes ♦	No*
#644				
#645				
#646				
#647				
#648				
#649				
#650				
#651				
#652				
#653				
#654				
#655				
#656				
#657				
#658				
#659				
#660				
#661				
#662				
#663				
#664				
#665				

♦ Factory Setting
 * If you select "No" display, this indicates a Marked System Speed Dial number which can override calling restrictions.

Dial Code	Name (11 characters maximum)	Telephone Number (40 digits maximum)	Display	
			Yes ♦	No*
#666				
#667				
#668				
#669				
#670				
#671				
#672				
#673				
#674				
#675				
#676				
#677				
#678				
#679				
#680				
#681				
#682				
#683				
#684				
#685				
#686				
#687				

♦ Factory Setting
 * If you select "No" display, this indicates a Marked System Speed Dial number which can override calling restrictions.

System Speed Dial

Dial Code	Name (11 characters maximum)	Telephone Number (40 digits maximum)	Display	
			Yes ◆	No*
#688				
#689				
#690				
#691				
#692				
#693				
#694				
#695				
#696				
#697				
#698				
#699				
#700				
#701				
#702				
#703				
#704				
#705				
#706				
#707				
#708				
#709				

◆ Factory Setting
 * If you select "No" display, this indicates a Marked System Speed Dial number which can override calling restrictions.

Dial Code	Name (11 characters maximum)	Telephone Number (40 digits maximum)	Display	
			Yes ♦	No*
#710				
#711				
#712				
#713				
#714				
#715				
#716				
#717				
#718				
#719				
#720				
#721				
#722				
#723				
#724				
#725				
#726				
#727				
#728				
#729				

♦ Factory Setting
 * If you select "No" display, this indicates a Marked System Speed Dial number which can override calling restrictions.

Data Forms

C

This appendix contains one copy of each data form. The forms are listed in [Table C-1](#). You should make copies of these forms and use the copies, keeping the originals for future use. The system planning forms are contained in [Appendix B](#). The T1/PRI Planner is contained in [Appendix D](#). The NI-1 BRI Planner is contained in [Appendix G](#). The Network Engineering forms are contained in [Appendix I](#).

Table C-1. Data Forms

Form No.	Form Title
1a	Modem Data Station
1b	ISDN Terminal Adapter Data Station
2	Data Hunt Groups
3	Digital Data/Video Station

Data Hunt Groups

(Make a copy for each group.)

Group Number (1 -32) _____ Factory-Set Ext. No. _____ Purpose of Group _____
 Group ID _____ RenumbeTo _____ _____

(example: Local Host Computer
 Access Workstation or LAN
 Access, etc.)

Stations

	Ext. No.	Person or Location		Ext. No.	Person or Location		Ext. No.	Person or Location		Ext. No.	Person or Location
1			6			11			16		
2			7			12			17		
3			8			13			18		
4			9			14			19		
5			10			15			20		

Trunks or Pools

Logical ID	Trunk or Pool	Logical ID	Trunk or Pool	Logical ID	Trunk or Pool	Logical ID	Trunk or Pool
1		21		41		61	
2		22		42		62	
3		23		43		63	
4		24		44		64	
5		25		45		65	
6		26		46		66	
7		27		47		67	
8		28		48		68	
9		29		49		69	
10		30		50		70	
11		31		51		71	
12		32		52		72	
13		33		53		73	
14		34		54		74	
15		35		55		75	
16		36		56		76	
17		37		57		77	
18		38		58		78	
19		39		59		79	
20		40		60		80	

Group Number _____

Group ID _____

Ext. No. _____

Calling Group Options

Hunt Type

- Circular ◆
- Linear

Delay Announcement

- No ◆
- Yes, Extension No. _____

Message-Waiting Receiver

- No ◆
- Yes, Extension No. _____

Calls-in-Queue Alarm Threshold

- 1 call ◆
- _____ calls (2-99)

External Alert for Calls-in-Queue Alarm

- No ◆
- Yes, Extension No. _____

Overflow Coverage

- No ◆
- Yes, Calling Group No. _____
- Yes, QCC LDN (queue) Extension No. _____

Overflow Threshold

- 1 call ◆
- _____ calls (2-99)

Group Type

- Auto Login
- Auto Logout ◆
- Integrated VMI
- Generic VMI

Coverage Group Receiver

- No
- Yes, Group No. _____
(See Form 6d.)

T1/PRI Planner

D

To ensure compatibility with the system, all local offerings of DS1 configurations must be reviewed by Lucent Technologies Sales and Design Support Center (SDSC) personnel. This review begins when SDSC receives the T1/PRI Planner form. This appendix contains instructions for completing the planner, including a blank form. You should make copies of the form pages and use the copies, keeping the originals for future use.



NOTE:

In Release 6.0 and later systems, T1 trunks are ordered for private networks. The MERLIN LEGEND System programs the T1 trunks as PRI trunks between the switches. See the *Network Reference* for more information on configuring a system in a private network.

The MERLIN LEGEND Communications System (Release 4.2 and later) is capable of supporting the services listed below for each type of central office switch:

- **AT&T Toll Services for 4ESS or 5ESS.** Megacom WATS, Megacom 800, ACCUNET SDS, Software Defined Network (SDN), MultiQuest, and Long Distance.
- **5ESS Local.** OUTWATS, 56/64 Digital, Virtual Private Network, and INWATS.
- **MCI Toll Services for DMS-250 or DEX600E.** MCI Prism, MCI VNet, MCI 800, MCI 900.
- **Local Exchange Carrier Services for DMS-100.** DMS Private Network, DMS INWATS (Inward Wide Area Telephone Service), DMS OUTWATS (Outward Wide Area Telephone Service), DMS FX (Foreign Exchange), DMS Tie Trunk.
- **Miscellaneous.** Call-by-Call, other.

For more information on the particular services, see the *Feature Reference*.

Planning Form Needed

T1/PRI Planner

Planning Form Instructions

1. On page 1, fill in the customer name, telephone number, and address.



NOTE:

The Reference Number is filled in by SDSC.

2. Fill in the Order Number.
3. Identify the personnel handling the account:
 - a. Account Executive's name and telephone number.
 - b. System Consultant's name and telephone number.
4. Identify the DS1 facility vendor by writing the vendor's name under the T1/PRI Vendor heading, along with the contact person's name and telephone number.
5. Under the Installation heading:
 - a. Write the Due Date on which the installation is scheduled to be complete.
 - b. Write the date the equipment is scheduled for delivery to the customer in the Materials-on-Job Date space.
6. Under the Installation Contacts heading, list the names and telephone numbers of the personnel responsible for the equipment order and its installation:
 - a. (Order) Implementor
 - b. SDSC Manager
 - c. National Technical Service Center (NTSC) Engineer
 - d. Data Services Organization (DSO) Manager
7. Under the question about whether the order has been placed:
 - If the order has been placed, check the Yes check box and fill in the date.
 - If the order has not been placed, check the No check box.

8. On page 2, complete one check box for each 100D module by transferring the options information for each module from the corresponding check box on Form 3b (page 1):
 - a. Service Ordered or Planned (Type of Service)
 - b. Frame Format
 - c. Switch Type
 - d. Line Coding (Suppression)
 - e. Line Signaling Mode
 - f. Synchronization Timing (Clock Synchronization: Source)
9. To ensure that the synchronization integrity of the DS1 network — both this communications system and its far-end connections — is protected, prepare the DS1 Planning Map on page 4 for review by SDSC. Describe the entire network of DS1 facilities by summarizing the following for each 100D module:
 - a. Fill in the control unit slot number or numbers of the 100D modules connected to the CSU or CSUs.
 - b. Write the approximate number of cable feet between each module and its CSU or far-end connection (refer to the Line Compensation entry on Form 3b, Page 1).
 - c. For the model number or numbers of the CSU or CSUs, do *one* of the following:
 - If the CSU is the ACCULINK 3150, check the check box for the ACCULINK 3150.
 - If the CSU is not the ACCULINK 3150, check the Other check box and write the manufacturer's name and model number in the space provided at the bottom of the page.
 - If no CSU is needed, check the None check box.
 - d. In the connection block or blocks, describe the DS1's far-end connection by doing *one* of the following:
 - If connected to the telephone company central office, check the central office check box.
 - If connected to another communications system, check the PBX check box.
 - If connected to the PRI network, check the PRI check box.
 - If the facility's type of service is T1, check the type or types of emulated trunks. Also, check the Services check box if the facility includes services such as MultiQuest with DNIS.

- e. Describe the clock synchronization sources according to the key at the lower left of the map.
 - Draw a circle and line from the clock source to the appropriate 100D module.
 - Label the circle **P** for primary, **S** for secondary, or **T** for tertiary.
10. Make a copy of the T1/PRI Planner for your records and forward the original to SDSC.

As an example, the system described in [Figure D-1](#) shows a processor module system with two 100D modules; this communications system is configured as follows:

- Module 1 in slot 04 is connected to an ACCULINK 3150 CSU, which is approximately 100 cable feet from the control unit. (The DS1 facility is connected to the PRI network.)
- Module 2 in slot 05 is connected to an ACCULINK 3150 CSU, which is approximately 160 cable feet from the control unit. (The far end is another communications system.)
- The primary clock synchronization source is the PRI network connected to Module 1. Its path is shown by a line and the letter **P**.
- The secondary clock synchronization path, shown by a line and the letter **S**, is the system internal clock.

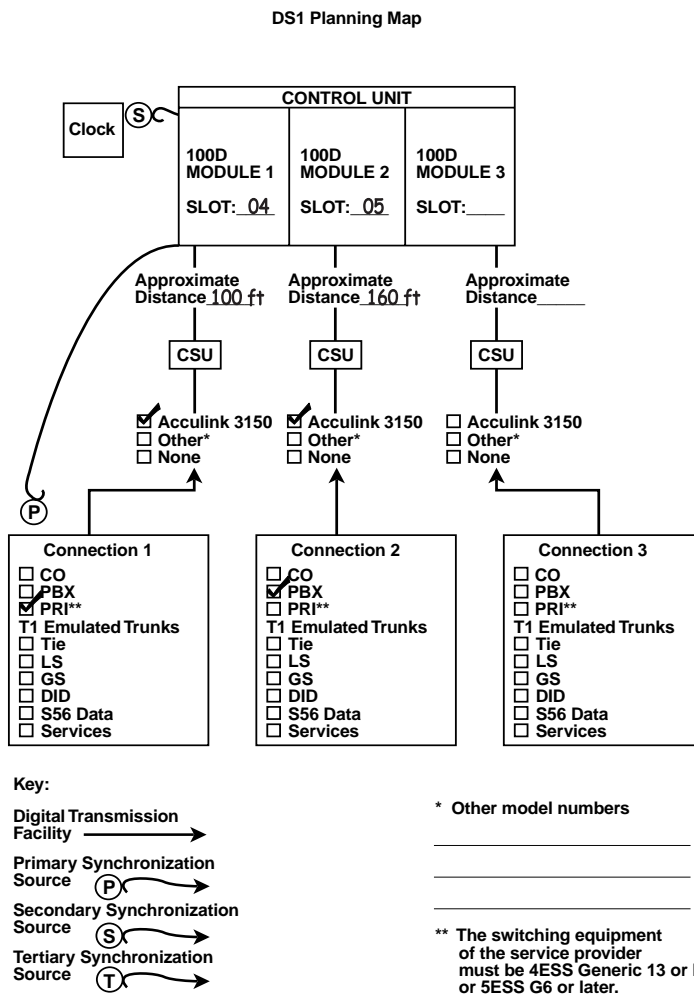

Figure D-1. Sample DS1 Planning Map

SDSC also evaluates the complexity of the facility configuration requested. Examples of complex configurations are connections into PBX networking applications, connections to multiplexing arrangements, or applications that involve customer engineering or design. SDSC then does *either* of the following:

- If an order is considered complex, SDSC directs you to the Business Communications System (BCS) National Engineering Center (NEC).
- If SDSC notifies you that the order's configuration is not complex, Tier III General Business System (GBS) National Technical Service Center (NTSC) is authorized to approve the configuration.

The NTSC group's preauthorization review is based, in part, on information you provide to them. Specifically, you must send them the following:

- A copy of the planner.
- A completed "Non-Complex Configuration" sheet (pages 5 through 10 of the Planner) for each 100D module you plan to install.

Complete one Non-Complex Configuration page (pages 5 through 10) for each 100D module. Label the top right corner of the copies "Page 1 of _" (1, 2, or 3). On each page:

1. Write the module number (1, 2, or 3). Indicate the total number of 100D modules (maximum of 3 for each system).
2. Fill in the control unit slot number (refer to page 1 of Form 3b).
3. In the Services section:
 - a. Check the check box next to each emulated trunk or service that will be connected. Check only those services allowed on the type of service (T1, AT&T Toll, MCI Toll, or DMS Local) selected for the module.
 - b. Circle the channel or channels to which each emulated trunk or service will be assigned.



NOTE:

No channel should show more than one trunk or service, and the 24th channel cannot be used if the signaling type is common channel.

4. If the type of service is PRI, complete the PRI Identification Service section by doing *either* of the following:
 - If you are not planning to use the number identification service, check the No check box and proceed to Step 5.
 - If you are planning to use the identification services, check the Yes check box and check the service planned:
 - For incoming calls, check one of the following check boxes: ANI, SID, or Both. If both automatic and extension identification service are planned, indicate the order in which the information should be displayed (ANI then SID or SID then ANI).
 - For outgoing calls, check either ANI, SID/ANI Privacy, SID – Extension Based, or SID – Line Based to indicate the service planned.



NOTE:

The availability of the caller identification information may be limited by local-serving (caller's) jurisdiction, availability, or central office equipment.

5. In the Channel Service Unit section:
 - a. Check the check box that describes the channel service unit used. If you are not using the model listed, check the second check box and write in the manufacturer information that describes the unit.
 - b. Forward all copies of this page, along with a copy of the Planner, to Tier III, GBS NTSC.

[Click here to view the T1/PRI Planner](#)

MERLIN LEGEND Communications System Release 7.0
T1/PRI Planner

For use with Form 3b, Incoming Trunks–DS1 Connectivity (100D Module)

Reference No. _____

Customer

*Name _____ Tel. No. _____

*Address _____

* Order Number _____

Account Executive _____ Tel. No. _____

Systems Consultant _____ Tel. No. _____

T1/PRI Vendor

*Name _____

Contact _____ Tel. No. _____

Installation

Due Date _____

Materials-on-Job Date _____

Installation Contacts

Implementor _____ Tel. No. _____

SDSC Manager _____ Tel. No. _____

NTSC Engineer _____ Tel. No. _____

DSO Manager _____ Tel. No. _____

Has order been placed with the network provider for this service?

Yes, Date _____

No

** Required fields for presale.*

***Module 1**

Service Ordered or Planned

- PRI
- T1

Frame Format

- ESF (Preferred)
- D4 (May be used if required by local telephone company)

Switch Type (PRI Service Only)

- 4ESS Legend-NTWK
- 5ESS Legend-PBX
- DMS-250
- DMS-100
- DXE600

Line Coding (Suppression)

- B8ZS (Preferred)
- AMI-ZCS

Line Signaling Mode

- Common Channel (Required for PRI)
- Local

Synchronization Timing

- Loop (Default)
- Local

***Module 2**

Service Ordered or Planned

- PRI
- T1

Frame Format

- ESF (Preferred)
- D4 (May be used if required by local telephone company)

Switch Type (PRI Service Only)

- 4ESS Legend-NTWK
- 5ESS Legend-PBX
- DMS-250
- DMS-100
- DXE600

Line Coding (Suppression)

- B8ZS (Preferred)
- AMI-ZCS

Line Signaling Mode

- Common Channel (Required for PRI)
- Local

Synchronization Timing

- Loop (Default)
- Local

** All fields required for presale*

***Module 3**

Service Ordered or Planned

- PRI
- T1

Frame Format

- ESF (Preferred)
- D4 (May be used if required by local telephone company)

Switch Type (PRI Service Only)

- 4ESS
- 5ESS
- DMS-250
- DMS-100
- DXE600
- Legend-NTWK
- Legend-PBX

Line Coding (Suppression)

- B8ZS (Preferred)
- AMI-ZCS

Line Signaling Mode

- Common Channel (Required for PRI)
- Local

Synchronization Timing

- Loop (Default)
- Local

DS1 Planning Map

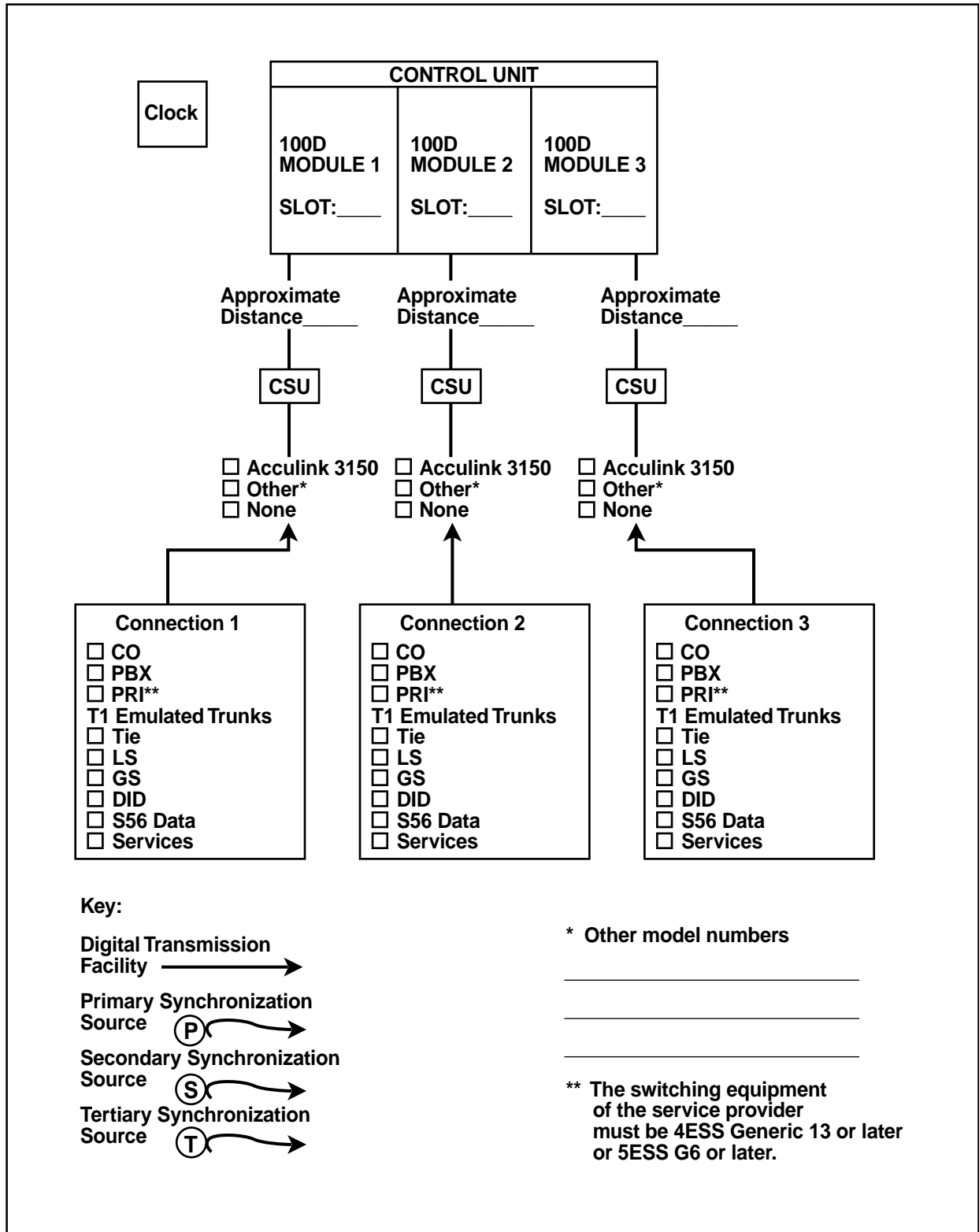

Non-Complex Configuration

Module _____ of _____ SlotNo. _____

Services*

Subscribed To:	Channels Assigned to Service
<input type="checkbox"/> Ground-start (T1 only)	1 2 3 4 5 6 7 8 9 10 11 12 13 14 15 16 17 18 19 20 21 22 23 24
<input type="checkbox"/> Loop-start (T1 only)	1 2 3 4 5 6 7 8 9 10 11 12 13 14 15 16 17 18 19 20 21 22 23 24
<input type="checkbox"/> Tie Trunk (T1 only)	1 2 3 4 5 6 7 8 9 10 11 12 13 14 15 16 17 18 19 20 21 22 23 24
<input type="checkbox"/> MultiQuest 900 (w/wo DNIS) (T1 or AT&T Toll)	1 2 3 4 5 6 7 8 9 10 11 12 13 14 15 16 17 18 19 20 21 22 23 24
<input type="checkbox"/> Megacom† <input type="checkbox"/> OUTWATS‡ (T1 or AT&T Toll)	1 2 3 4 5 6 7 8 9 10 11 12 13 14 15 16 17 18 19 20 21 22 23 24
<input type="checkbox"/> Megacom 800 <input type="checkbox"/> INWATS‡ (w/wo DNIS)† (T1 or AT&T Toll)	1 2 3 4 5 6 7 8 9 10 11 12 13 14 15 16 17 18 19 20 21 22 23 24
<input type="checkbox"/> Megacom/ Megacom 800† <input type="checkbox"/> OUTWATS/ INWATS‡ (T1 or AT&T Toll)	1 2 3 4 5 6 7 8 9 10 11 12 13 14 15 16 17 18 19 20 21 22 23 24
<input type="checkbox"/> SDN† <input type="checkbox"/> VPN† (T1 or AT&T Toll)	1 2 3 4 5 6 7 8 9 10 11 12 13 14 15 16 17 18 19 20 21 22 23 24
<input type="checkbox"/> ACCUNET Switched <input type="checkbox"/> 56/64 Digital‡ Digital Service (AT&T Toll only)	1 2 3 4 5 6 7 8 9 10 11 12 13 14 15 16 17 18 19 20 21 22 23 24
<input type="checkbox"/> ACCUNET Switched 56 Digital Data Service (T1 only)	1 2 3 4 5 6 7 8 9 10 11 12 13 14 15 16 17 18 19 20 21 22 23 24
<input type="checkbox"/> DID (T1 only)	1 2 3 4 5 6 7 8 9 10 11 12 13 14 15 16 17 18 19 20 21 22 23 24
<input type="checkbox"/> Call-by-Call Service Selection (AT&T Toll only)	1 2 3 4 5 6 7 8 9 10 11 12 13 14 15 16 17 18 19 20 21 22 23 24
<input type="checkbox"/> MCI PRISM†† <input type="checkbox"/> MCI Vnet†† (MCI Toll)	1 2 3 4 5 6 7 8 9 10 11 12 13 14 15 16 17 18 19 20 21 22 23 24
<input type="checkbox"/> MCI 800†† <input type="checkbox"/> MCI 900†† (MCI Toll)	1 2 3 4 5 6 7 8 9 10 11 12 13 14 15 16 17 18 19 20 21 22 23 24
<input type="checkbox"/> DMS Private# <input type="checkbox"/> DMS INWATS# (DMS Local)	1 2 3 4 5 6 7 8 9 10 11 12 13 14 15 16 17 18 19 20 21 22 23 24
<input type="checkbox"/> DMS OUTWATS# <input type="checkbox"/> DMS FX# (DMS Local)	1 2 3 4 5 6 7 8 9 10 11 12 13 14 15 16 17 18 19 20 21 22 23 24
<input type="checkbox"/> DMS Tie Trunk# Digital Service (PRI only)	1 2 3 4 5 6 7 8 9 10 11 12 13 14 15 16 17 18 19 20 21 22 23 24

* Required fields for presale

† 4ESS

‡ 5ESS

†† DMS-250 or DEX600

DMS-100

Non-Complex Configuration

Module _____ of _____ Slot No. _____

PRI Identification Service

*Will SID/ANI be used?	<input type="checkbox"/> No	<input type="checkbox"/> Yes		
Incoming calls	<input type="checkbox"/> ANI	<input type="checkbox"/> SID	<input type="checkbox"/> Both ... Prefer _____ then _____	
Outgoing calls	<input type="checkbox"/> ANI	<input type="checkbox"/> SID/ANI Privacy	<input type="checkbox"/> SID - Extension Based	<input type="checkbox"/> SID - Line Based

Channel Service Unit

<input type="checkbox"/>	<input type="checkbox"/>	<input type="checkbox"/>	<input type="checkbox"/>
Mfr	AT&T Paradyne	_____	_____
Model	3150	_____	_____
REG#	AW2USA-74673-DD-E	_____	_____

§ If a CSU other than the one listed AT&T models is used, AT&T will not accept the responsibility for its installation, connection, or testing.

* Required fields for presale

Non-Complex Configuration

Module _____ of _____ SlotNo. _____

Services*

Subscribed To:	Channels Assigned to Service
<input type="checkbox"/> Ground-start (T1 only)	1 2 3 4 5 6 7 8 9 10 11 12 13 14 15 16 17 18 19 20 21 22 23 24
<input type="checkbox"/> Loop-start (T1 only)	1 2 3 4 5 6 7 8 9 10 11 12 13 14 15 16 17 18 19 20 21 22 23 24
<input type="checkbox"/> Tie Trunk (T1 only)	1 2 3 4 5 6 7 8 9 10 11 12 13 14 15 16 17 18 19 20 21 22 23 24
<input type="checkbox"/> MultiQuest 900 (w/wo DNIS) (T1 or AT&T Toll)	1 2 3 4 5 6 7 8 9 10 11 12 13 14 15 16 17 18 19 20 21 22 23 24
<input type="checkbox"/> Megacom† <input type="checkbox"/> OUTWATS‡ (T1 or AT&T Toll)	1 2 3 4 5 6 7 8 9 10 11 12 13 14 15 16 17 18 19 20 21 22 23 24
<input type="checkbox"/> Megacom 800 <input type="checkbox"/> INWATS‡ (w/wo DNIS)† (T1 or AT&T Toll)	1 2 3 4 5 6 7 8 9 10 11 12 13 14 15 16 17 18 19 20 21 22 23 24
<input type="checkbox"/> Megacom/ Megacom 800† <input type="checkbox"/> OUTWATS/ INWATS‡ (T1 or AT&T Toll)	1 2 3 4 5 6 7 8 9 10 11 12 13 14 15 16 17 18 19 20 21 22 23 24
<input type="checkbox"/> SDN† <input type="checkbox"/> VPN† (T1 or AT&T Toll)	1 2 3 4 5 6 7 8 9 10 11 12 13 14 15 16 17 18 19 20 21 22 23 24
<input type="checkbox"/> ACCUNET Switched <input type="checkbox"/> 56/64 Digital‡ Digital Service (AT&T Toll only)	1 2 3 4 5 6 7 8 9 10 11 12 13 14 15 16 17 18 19 20 21 22 23 24
<input type="checkbox"/> ACCUNET Switched 56 Digital Data Service (T1 only)	1 2 3 4 5 6 7 8 9 10 11 12 13 14 15 16 17 18 19 20 21 22 23 24
<input type="checkbox"/> DID (T1 only)	1 2 3 4 5 6 7 8 9 10 11 12 13 14 15 16 17 18 19 20 21 22 23 24
<input type="checkbox"/> Call-by-Call Service Selection (AT&T Toll only)	1 2 3 4 5 6 7 8 9 10 11 12 13 14 15 16 17 18 19 20 21 22 23 24
<input type="checkbox"/> MCI PRISM†† <input type="checkbox"/> MCI Vnet†† (MCI Toll)	1 2 3 4 5 6 7 8 9 10 11 12 13 14 15 16 17 18 19 20 21 22 23 24
<input type="checkbox"/> MCI 800†† <input type="checkbox"/> MCI 900†† (MCI Toll)	1 2 3 4 5 6 7 8 9 10 11 12 13 14 15 16 17 18 19 20 21 22 23 24
<input type="checkbox"/> DMS Private# <input type="checkbox"/> DMS INWATS# (DMS Local)	1 2 3 4 5 6 7 8 9 10 11 12 13 14 15 16 17 18 19 20 21 22 23 24
<input type="checkbox"/> DMS OUTWATS# <input type="checkbox"/> DMS FX# (DMS Local)	1 2 3 4 5 6 7 8 9 10 11 12 13 14 15 16 17 18 19 20 21 22 23 24
<input type="checkbox"/> DMS Tie Trunk# Digital Service (PRI only)	1 2 3 4 5 6 7 8 9 10 11 12 13 14 15 16 17 18 19 20 21 22 23 24

* Required fields for presale

†4ESS

‡5ESS

†† DMS-250 or DEX600

DMS-100

Non-Complex Configuration

Module _____ of _____ Slot No. _____

PRI Identification Service

*Will SID/ANI be used?	<input type="checkbox"/> No	<input type="checkbox"/> Yes	
Incoming calls	<input type="checkbox"/> ANI	<input type="checkbox"/> SID	<input type="checkbox"/> Both... Prefer _____ then _____
Outgoing calls	<input type="checkbox"/> ANI	<input type="checkbox"/> SID/ANI Privacy	<input type="checkbox"/> SID-Extension Based <input type="checkbox"/> SID-Line Based

Channel Service Unit

	<input type="checkbox"/>	<input type="checkbox"/> §
Mfr	AT&T Paradyne	_____
Model	3150	_____
REG#	AW2USA-74673-DD-E	_____
<i>§ If a CSU other than the one listed AT&T models is used, AT&T will not accept the responsibility for its installation, connection, or testing.</i>		

* Required fields for presale

Non-Complex Configuration

Module _____ of _____ SlotNo. _____

Services*

Subscribed To:	Channels Assigned to Service
<input type="checkbox"/> Ground-start (T1 only)	1 2 3 4 5 6 7 8 9 10 11 12 13 14 15 16 17 18 19 20 21 22 23 24
<input type="checkbox"/> Loop-start (T1 only)	1 2 3 4 5 6 7 8 9 10 11 12 13 14 15 16 17 18 19 20 21 22 23 24
<input type="checkbox"/> Tie Trunk (T1 only)	1 2 3 4 5 6 7 8 9 10 11 12 13 14 15 16 17 18 19 20 21 22 23 24
<input type="checkbox"/> MultiQuest 900 (w/wo DNIS) (T1 or AT&T Toll)	1 2 3 4 5 6 7 8 9 10 11 12 13 14 15 16 17 18 19 20 21 22 23 24
<input type="checkbox"/> Megacom† <input type="checkbox"/> OUTWATS‡ (T1 or AT&T Toll)	1 2 3 4 5 6 7 8 9 10 11 12 13 14 15 16 17 18 19 20 21 22 23 24
<input type="checkbox"/> Megacom 800 <input type="checkbox"/> INWATS‡ (w/wo DNIS)† (T1 or AT&T Toll)	1 2 3 4 5 6 7 8 9 10 11 12 13 14 15 16 17 18 19 20 21 22 23 24
<input type="checkbox"/> Megacom/ Megacom 800† <input type="checkbox"/> OUTWATS/ INWATS‡	1 2 3 4 5 6 7 8 9 10 11 12 13 14 15 16 17 18 19 20 21 22 23 24
<input type="checkbox"/> SDN† <input type="checkbox"/> VPN† (T1 or AT&T Toll)	1 2 3 4 5 6 7 8 9 10 11 12 13 14 15 16 17 18 19 20 21 22 23 24
<input type="checkbox"/> ACCUNET Switched <input type="checkbox"/> 56/64 Digital‡ Digital Service (AT&T Toll only)	1 2 3 4 5 6 7 8 9 10 11 12 13 14 15 16 17 18 19 20 21 22 23 24
<input type="checkbox"/> ACCUNET Switched 56 Digital Data Service (T1 only)	1 2 3 4 5 6 7 8 9 10 11 12 13 14 15 16 17 18 19 20 21 22 23 24
<input type="checkbox"/> DID (T1 only)	1 2 3 4 5 6 7 8 9 10 11 12 13 14 15 16 17 18 19 20 21 22 23 24
<input type="checkbox"/> Call-by-Call Service Selection (AT&T Toll only)	1 2 3 4 5 6 7 8 9 10 11 12 13 14 15 16 17 18 19 20 21 22 23 24
<input type="checkbox"/> MCI PRISM†† <input type="checkbox"/> MCI Vnet†† (MCI Toll)	1 2 3 4 5 6 7 8 9 10 11 12 13 14 15 16 17 18 19 20 21 22 23 24
<input type="checkbox"/> MCI 800†† <input type="checkbox"/> MCI 900†† (MCI Toll)	1 2 3 4 5 6 7 8 9 10 11 12 13 14 15 16 17 18 19 20 21 22 23 24
<input type="checkbox"/> DMS Private# <input type="checkbox"/> DMS INWATS# (DMS Local)	1 2 3 4 5 6 7 8 9 10 11 12 13 14 15 16 17 18 19 20 21 22 23 24
<input type="checkbox"/> DMS OUTWATS# <input type="checkbox"/> DMS FX# (DMS Local)	1 2 3 4 5 6 7 8 9 10 11 12 13 14 15 16 17 18 19 20 21 22 23 24
<input type="checkbox"/> DMS Tie Trunk# Digital Service (PRI only)	1 2 3 4 5 6 7 8 9 10 11 12 13 14 15 16 17 18 19 20 21 22 23 24

* Required fields for presale

† 4ESS

‡ 5ESS

†† DMS-250 or DEX600

DMS-100

Non-Complex Configuration

Module ____ of ____ Slot No. _____

PRI Identification Service

*Will SID/ANI be used?	<input type="checkbox"/> No	<input type="checkbox"/> Yes
Incoming calls	<input type="checkbox"/> ANI	<input type="checkbox"/> SID
Outgoing calls	<input type="checkbox"/> ANI	<input type="checkbox"/> SID/ANI Privacy
	<input type="checkbox"/> Both... Prefer ____ then ____	<input type="checkbox"/> SID-Extension Based
		<input type="checkbox"/> SID-Line Based

Channel Service Unit

	<input type="checkbox"/>	<input type="checkbox"/> §
Mfr	AT&T Paradyne	_____
Model	3150	_____
REG#	AW2USA-74673-DD-E	_____

§ If a CSU other than the one listed AT&T models is used, AT&T will not accept the responsibility for its installation, connection, or testing.

* Required fields for presale

DS1 Connectivity Ordering



After the contract is signed, the sales representative or authorized dealer contacts the DS1 connectivity vendor to discuss the T1/PRI service order. The vendor needs information about the communications system as well as customer identification. [Table E-1](#) describes the kind of information the vendor requires. This table should be reviewed with the customer's network representative or dealer so the information will be available when needed.

Table E-1. Guide to DS1 Connectivity Ordering

Communications System:	
Model	MERLIN LEGEND
Type (Mode)	Digital PBX
Jack Type	RJ48C or RJ48X
Facility Interface Code	Digital D4 Framing Digital ESF Framing Digital ESF and B8ZS

Digital PBX

The following conditions relate to the Digital PBX:

- It has the EIA standard CISA transmission path.
- It is senderized.
- It is the equipment that must be timed.
- It has an internal stratum clock level of 4.
- It provides automatic call distribution through the Group Calling feature.
- It provides loopback (keeps signal alive) through the CSU.

Table E-2. Channel Service Unit (CSU)

Manufacturer:	AT&T	Other _____
Model:	3150	_____
Reg. Number:	AW2USA-74673-DD-E	_____
Facility Interface Codes:	_____	_____
Digital D4 Framing:	Digital ESF Framing Digital ESF and B8ZS	

Standard CSU jacks and test point are provided.

Audible Ringing Source

- Digital PBX
- Channel Service

Testing Service

- AT&T
- Other _____

If a CSU other than those listed above is used, Lucent Technologies will not accept the responsibility for its installation, connection, or testing.

Echo Control Device

Not used.

Unit Load Calculation



A unit load is a measure of power (1.9 watts) used to determine the electrical load that the following components have on *each carrier's* power supply:

- **Telephones and Adjuncts.** Only the telephones and adjuncts that connect to the analog and digital ports on the control unit require unit load calculation. Do not include any equipment with its own power supply in the unit load calculation.
- **Direct Inward Dial (DID) modules.**

Unit load and power requirements for a new system are computed automatically when the equipment for the system is initially ordered. These calculations are based on the assumption that each module is fully utilized—that is, all jacks are used.

It may be useful to obtain more accurate calculations—for example, if the modules are not fully utilized, if there is a change in the equipment, or if you suspect that a particular carrier has more unit loads than the power supply can handle. You can calculate the actual unit load using the worksheet and instructions in this appendix.

Unit Load Rules

A general rule to follow is that if you can distribute the DID modules and telephone modules equally across the carriers, you will prevent unnecessary drain on any one carrier.

Also, depending on the system's mode, the rules vary. This section provides the rules for calculating unit loads for the different modes.

Unit Loads for the Hybrid/PBX Mode

The 391A1 and 391A2 power supplies have a maximum rating of 48 unit loads and generally can support six modules of any type in a system in Hybrid/PBX mode — without exceeding the 48-unit maximum. If, however, *both* of the following conditions are true, the unit loads on a carrier might exceed the 48-unit maximum:

- All six carrier slots are occupied by MLX or analog multiline telephone modules.
- The carrier has a total of more than 45 MLX-20L telephones or 34-button analog multiline telephones installed.

The 391C1 power supply has a maximum rating of 96 unit loads; the 391A3 power supply has a maximum rating of 72 unit loads. If your system contains a 391A1 or 391A2 power supply module, and the unit loads for that carrier will exceed 48, a 391C1 or 391A3 power supply should be installed in the system. The 391A3 can handle up to 72 MLX telephones, and the 391C1 can handle up to 96 MLX telephones.

Table F-1. Power Supplies and MLX, ETR, and MLS Telephones

Power Supply	Maximum No. of MLX, ETR, or MLS Telephones per Carrier
391A1	48
391A2	48
391A3	72
391C1	96

Unit Loads for Key or Behind Switch Mode

In a Key or Behind Switch system with four or fewer modules, no calculation is needed. The power supply generally supports four modules of any type in Key or Behind Switch mode.

Calculating Unit Loads

Use the worksheet and instructions in this appendix to calculate unit loads for each carrier. Make a copy of all pages of the worksheet for each carrier.

Unit Load Worksheet

1. Number of modules in carrier (excluding power supply and processor): _____

- If fewer than 5, no further calculation is required.
- If 5 or 6, continue to Step 2.

2. Key or Behind Switch mode only: Key

Indicate the configuration of lines; then go to Step 5. Modified

3. Hybrid/PBX mode only:

Do all modules in the carrier have MLX and/or analog multiline telephone jacks? Yes
 No

- If no, no further calculation is required.
- If yes, continue to Step 4.

4. Hybrid/PBX mode only:

Calculate the total number of MLX and analog multiline telephones.

Number of MLX-20L telephones connected to modules in the carrier: _____

Number of MLX-28D telephones connected to modules in the carrier: _____

Number of 34-button analog multiline telephones connected to modules in the carrier: _____

Total of MLX-20L, MLX-28D, and 34-button analog telephones: _____

- If the total is less than 45, no further calculation is required.
- If the total is 45 or more, continue to Step 5.

5. Calculate the estimated unit loads by using the following table.

Module	Qty	x	Unit Load	= Total
008 (ATL)			12.0	
008 MLX			13.25	
016 MLX			13.25	
008 OPT			8.0	
012 (T/R)			8.4	
016 ETR			24	
016 (T/R)			12.8	
100D			0.0	
400 (LS)			0.0	
400 EM			8.0	
400 GS/LS/TTR			0.0	
408 (LS-ATL)			12.0	
408 GS/LS			12.0	
408 GS/LS-MLX			13.5	
408 GS/LS-ID-MLX			13.5	
412 LS-ID-ETR			18	
800 (LS)			0.0	
800 GS/LS			0.0	
800 GS/LS-ID			0.0	
800 DID			8.0	
800 NI-BRI			0.0	
MERLIN LEGEND Mail			0.0	
Total Estimated Unit Load:				

- If the total is less than 96 (for the 391C1 power supply), 72 (for the 391A3 power supply), or 48 (for the 391A1 or 391A2 power supplies), no further calculation is required.
- If the total is 96 (391C1 power supply), 72 (391A3 power supply), or 48 (391A1 or 391A2 power supplies) or more, continue to Step 6.

6. Calculate the actual carrier unit load using the following table.
- If the total actual unit load is less than or equal to 96 (391C1 power supply), 72 (for the 391A3 power supply), or less than or equal to 48 (391A1 or 391A2 power supplies), no further calculation is required.
 - If the total actual unit load is more than 96 (391C1 power supply), 72 (for the 391A3 power supply), or 48 (391A1 or 391A2 power supplies), continue to Step 7.

	Qty x	Unit Load		= Total
Equipment		Hybrid/PBX or Modified	Key	
Network Access Lines¹				
DID		1.0	0.0	
DS1		0.0	0.0	
NI-1 BRI		0.0	0.0	
GS/LS		0.0	0.0	
Tie		1.4	1.4	
Telephones				
MLX-5		0.9	1.2	
MLX-5D		0.9	1.2	
MLX-10		0.9	1.2	
MLX-10D		0.9	1.2	
MLX-10DP		0.9	1.2	
MLX-16DP		1.5	1.5	
MLX-28D		1.2	1.7	
MLX-20L		1.1	1.6	
ETR-6		0.8	0.8	
ETR-18		0.9	0.9	
ETR-18D		1.0	1.0	
ETR-34D		1.0	1.0	
MLS-6		0.7	0.7	
MLS-12		0.8	0.8	

	Qty x	Unit Load		= Total
Equipment		Hybrid/PBX or Modified	Key	
MLS-12D		0.8	0.8	
MLS-18D		0.8	0.8	
MLS-34D		0.9	0.9	
BIS-10		0.9	1.1	
BIS-22		1.0	1.3	
BIS-22D		1.0	1.3	
BIS-34		1.1	1.5	
BIS-34D		1.1	1.5	
Business Cordless 905		0.0	0.0	
MLC-5		0.0	0.0	
MDC 9000		0.0	0.0	
MDW 9000		0.0	0.0	
10-Button Basic		0.9	1.1	
10-Button HFAI		1.0	1.2	
34-Button Basic		0.9	1.1	
34-Button DLX		1.2	1.7	
34-Button BIS		1.2	1.4	
34-Button BIS/DIS		1.2	1.4	
Single-Line Telephone		0.6	0.7	

Equipment	Qty x	Unit Load		= Total
		Hybrid/PBX or Modified	Key	
Optional Equipment²				
Direct Station Selector ³		0.7	0.9	
General-Purpose Adapter		0.8	1.0	
Hands-Free Unit		0.8	1.0	
Headset Adapter		0.8	1.0	
EICON board		0.0	0.0	
Total Actual Unit Load:				

- 1 Unit loads are computed for each trunk for trunk-type network access lines.
- 2 The MFM has its own wall power unit located at the telephone and, therefore, is not added to the unit load calculation.
- 3 Up to two DSSs (one DSS for each MLX-28D or MLX-20L) can be powered from each control unit carrier. For example, a three-carrier system can have six system operator positions, each with one DSS powered from the control unit.

7. Try to exchange modules between carriers to reduce the unit loads to 96 (if a 391C1 power supply is installed), 72 (if a 391A3 power supply is installed), or 48 (if a 391A1 or 391A2 power supply is installed). (Remember that the 100D, 800 NI-BRI, 400 (LS), 400 GS/LS, 800 (LS), and 800 GS/LS modules have unit loads of 0.0.) Repeat Steps 1 through 6 to recalculate unit loads for the new configuration.
 - Empty slots are not permitted between modules.
 - If the exchange reduces the unit load to below the rated maximum for your power supply module, no further calculation is required.
 - If your system has a 391A1 or 391A2 power supply and the exchange does not reduce the unit load to 48, replace the 391A1 or 391A2 power supply with a 391C1 power supply. If your system has a 391A3 power supply and the exchange does not reduce the unit load to 72, replace the 391A3 power supply with a 391C1 power supply. If your system has a 391C1 power supply and the exchange does not reduce the unit load to 96, install wall power units for the appropriate number of telephones to reduce the unit load to 96.

NI-1 BRI Review



This appendix contains instructions for completing the NI-1 BRI Planner Form. If you have questions while completing the form prior to the sale, contact the Sales and Design Support Center (SDSC) engineers. Once the contract has been signed and the forms are completed, make a photocopy of the forms for your records and forward the forms to the technician who will do the installation. The technician will then fax a copy to the National Service Assistance Center (NSAC) if any questions or problems occur at the customer site.

The NI-1 BRI Planner Form should be used in conjunction with System Form 3i, Incoming Trunks: BRI Options (800 NI-BRI Module).

Form Needed

NI-1 BRI Planner

Planning Form Instructions



NOTE:

Prior to completing any of the steps below, you should first verify that the customer's local service provider offers National ISDN-1 BRI service with ISDN Ordering Code (IOC) standardized capability package "S" and a separate Multi-Line Hunt (MLH) service, depending on the customer's requirements. If the Central Office uses a Lucent Technologies 5ESS or Siemens SSC EWSD switch, MLH is available through the Series Completion feature. The Multiline Hunt Group (MLHG) feature on these central office switches is not recommended for use with MERLIN LEGEND. The Northern Telecom DMS-100 provides MLH service through the MLHG feature. A customer may want to order several BRI lines, some assigned as IOC package "S" and the others as MLH.

To properly order and program NI-1 BRI service, it may be necessary to contact the local service provider to determine what services are available and the type of switching equipment used. See [Appendix H, "NI-1 BRI Provisioning,"](#) for detailed information that the local service provider may require in order to supply the necessary connections.

1. On page 1, fill in the customer name, telephone number, and address.



NOTE:

Reference Number is filled in by SDSC.

2. Fill in the Order Number.
3. Identify the personnel handling the account:
 - a. Account Executive's name and telephone number.
 - b. System Consultant's name and telephone number.
4. Identify the NI-1 BRI facility vendor by writing the vendor's name under the NI-1 BRI Vendor heading, along with the contact person's name and telephone number.
5. Under the Installation heading:
 - a. Write the Due Date on which the installation is scheduled to be completed.
 - b. Write the date the equipment is scheduled for delivery to the customer in the Materials-on-Job Date space.
6. Under the Installation Contacts heading, list the names and telephone numbers of the personnel responsible for the equipment order and its installation:
 - a. (Order) Implementor
 - b. SDSC Manager
 - c. National Technical Service Center (NTSC) Engineer
 - d. Data Services Organization (DSO) Manager
7. Under the question about whether the order has been placed:
 - If the order has been placed, check the Yes check box and fill in the expected service turn on date.
 - If the order has not been placed, check the No check box.
8. On page 2, enter the type of BRI service to be ordered. Since MERLIN LEGEND Release 4.0 supports only National ISDN-1 BRI (2B+D) service, enter NI-1 BRI in the space provided under the Type of Service heading.

9. Contact the local service provider and determine what type of central office switch serves your area (for example, Lucent Technologies 5ESS, Northern Telecom DMS-100, or Siemens SSC EWSD). Enter this information under the "Type of CO Switch" heading on page 2 of the form.
10. Determine which type of configuration is best suited for your system. Some guidelines for selecting the service configuration are shown below:
 - **IOC Capability Package "S."** Each BRI line, also called a Digital Subscriber Line (DSL), consists of two B-channels, both of which support voice and data calls. In order to have two simultaneous voice or digital data calls, the central office must assign two Directory Numbers (DNs) and two Service Profile Identifiers (SPIDs) to each DSL. Basic call-handling is supported, along with the Calling Party Number/Billing Number (CPN/BN) identification feature. No packet data capabilities or hunting features are provided.

 **NOTES:**

- On the Lucent Technologies 5ESS switch, the Calling Party Number identification feature is assigned using the standard BRCS preconstructed features /LICNDA and /CPCOFA. If it is possible, request /CPCPFA for the Calling Number Identification feature from your local service provider as it provides a clearer display of the CPN information.
- IOC package "S" supports a maximum of one call per telephone number (DN) at any given time. If another call comes in on that line, the caller gets a busy signal.
- For Canada and those areas of the United States where IOC package "S" is not available, the capability package that is ordered must provide alternate voice/circuit-switched data on both B-channels with no packet data capability or supplementary voice features except for the CPN/BN feature, if available. See [Appendix H, "NI-1 BRI Provisioning"](#) for detailed information.
- **Multiline Hunt (MLH).** This feature is not part of the IOC package "S" and must be provisioned separately.

One or more BRI lines (and their associated DNs) are grouped together with one (main) telephone number. When an incoming call arrives at the main number, the central office searches through the DNs until an available line is found.

 **NOTE:**

Each DN in the MLH group can be dialed directly, but hunting may not be initiated (depending on the central office switch).

For the Siemens SSD EWSD switch, each MLH group must be assigned as either voice or data; alternate voice/data is not supported since mixing the two types in one group could create call interference. This constraint does not apply to the Lucent Technologies 5ESS or the Northern Telecom DMS-100 switches.

The programming for Multiline Hunt is central office switch dependent. The Lucent Technologies 5ESS and Siemens SSC EWSD switches provide hunting through the Series Completion feature. The Northern Telecom DMS-100 switch provides hunting through the Multiline Hunt Group (MLHG) feature. Contact the local service provider to determine what type of switching equipment is in use and check the appropriate check box under the MLH subheading of the Service Configurations section on page 2 of the form.

The MERLIN LEGEND Communications System has currently been tested with each switch type in the following configurations:

- Lucent Technologies 5ESS in a linear hunt group
- Northern Telecom DMS-100 in a circular hunt group
- Siemens SSC EWSD in a circular hunt group

Other configurations are possible, but are not guaranteed to work.

[Appendix H, "NI-1 BRI Provisioning,"](#) provides sample LEC programming screens of the Series Completion and MLHG features. These screens show the fields and parameters for the central office switch and may be forwarded to the local service provider if necessary.

11. Once you have determined your Service Configuration, do *either* of the following:
 - If your Service Configuration will be IOC "S," check the check box beside the IOC "S" selection under the Service Configuration heading, then enter the number of BRI lines that will be provisioned using this package.
 - If your Service Configuration will be MLH, check the check box beside the MLH selection under the Service Configurations heading.
 - Check the check box for MLHG (Northern Telecom DMS-100) or Series Completion (Lucent Technologies 5ESS or Siemens SSC EWSD).
 - Enter the total number of BRI lines provisioned using MLH, the number of BRI lines provisioned as voice only hunt groups, the number of BRI lines provisioned as data only hunt groups, and the number of BRI lines provisioned as voice/data hunt groups in the spaces provided.

 **NOTE:**

MERLIN LEGEND Release 4.0 does not support voice/data hunt groups with the Siemens SSC EWSD central office switch.

12. Specify the total number of BRI lines under the Number of BRI Lines Ordered heading.
13. If CPN/BN is available with the BRI lines ordered, check the CPN/BN check box under the Additional Features heading.
14. Make a copy of the NI-1 BRI Planner for your records and forward the original to the technician who will perform the installation.

[Click here to view the NI-1 BRI Planner](#)

MERLIN LEGEND Communications System Release 7.0
NI-1 BRI Planner

For use with Form 3i, Incoming Trunks: BRI Options (800 NI-BRI Module)

Reference No. _____

Customer

*Name _____ Tel. No. _____

*Address _____

* Order Number _____

Account Executive _____ Tel. No. _____

Systems Consultant _____ Tel. No. _____

NI-1 BRI Vendor

*Name _____

Contact _____ Tel. No. _____

Installation

Due Date _____

Materials-on-Job Date _____

Installation Contacts

Implementor _____ Tel. No. _____

SDSC Manager _____ Tel. No. _____

NTSC Engineer _____ Tel. No. _____

DSO Manager _____ Tel. No. _____

Has order been placed with the network provider for this service?

Yes, Date _____

No

** Required fields for presale.*

Type of Service*

Type of CO Switch

Service Configurations

IOC"S"

Number of BRI Lines Provisioned _____

MLH: MLHG Series Completion

Number of BRI Lines Provisioned _____

Number of Voice Only Hunt Groups Provisioned _____

Number of Data Only Hunt Groups Provisioned _____

Number of Voice/Data Hunt Groups Provisioned† _____

Number of BRI Lines Ordered

Additional Features

CPN/BN

* MERLIN LEGEND Release 4.0 supports only National ISDN-1 BRI (2B + D) service.

† MERLIN LEGEND Release 4.0 does not support Voice/Data Hunt Groups with the Siemens SSC EWSD Central Office Switch.

NI-1 BRI Provisioning



This appendix provides detailed information concerning the features and translations that make up the ISDN Ordering Code (IOC) standardized capability package "S," as well as the Multiline Hunt (MLH) feature. The MLH feature is provisioned using either the Multiline Hunt Group or the Series Completion feature, depending on the central office switch type.

Specific translations are provided for the following switches:

- Lucent Technologies 5ESS
- Northern Telecom DMS-100
- Siemens SSC EWSD

After determining that the local service provider offers National ISDN-1 service, the information contained in this appendix should be given to the local service provider, if necessary.



NOTE:

The programming screens shown in this appendix are representative samples only. The local service provider will need to enter applicable data (such as the telephone numbers) where necessary. Also note that the programming covered in this appendix *does not* take place on the MERLIN LEGEND Communications System. All programming is performed by the local service provider on the central office switch.

Lucent Technologies 5ESS Switch Translations

For the Lucent Technologies 5ESS switch, Capability Package "S" includes alternate voice/circuit-switched data on two B-channels. It also supports Calling Number Identification on data and voice connections. Please note that in order to have simultaneous calls on the two B-channels, two Directory Numbers (DNs) must be assigned with this package.

The Lucent Technologies 5ESS switch also allows alternate voice and data hunting on one DN using the Series Completion feature.

ISDN Capability Package "S"

The information listed below provides the DN translations that define Capability Package "S," and the screens and fields that must be programmed.

The information provided shows the translations for one Digital Subscriber Line (DSL) and two DNs. For multiple DSLs/DNs, the central office will duplicate these screens and enter the applicable DSL and DN values as needed.

ISDN Ordering Code: Capability S

VIEW 23.2

DN1 Translations

Fields that must be programmed on Screens 1, 2, 3, and 4:

1	DSL TN	<C plus Telephone number>
9	ASSOC	<U>
11	OE	<enter OE and type>
14	D ISCN	<enter value>
15	DSERV	<SX>
16	B1SERV	<DMD>
17	B2SERV	<DMD>
18	NT1 TYPE	<enter NT1 type>
20	DSL CLS	<STD>
21	RSTR MP	<N>
23	MDPKT	<0>
24	MTERM	<2>
28	USPID	<enter value>
29	MAXB CHL	<2>
30	ACT USER	<Y>

Fields that must be populated on Screens 4, 5, and 6:

34	CKT TN	<enter TN>
35	CKT LCC	<enter LCC>
36	CKT RAX	<enter RAX value>
41	TERMTYP	<TYPEA>
42	DISPLAY	<Y>
46	CSV	<1>
47	CSV CHL	<ANY>
49	CSV LIMIT	<1>
55	CSD	<2>
56	CSD CHL	<ANY>
58	CSD LIMIT	<2>
126	CPN SCRN	<Y>
91	PIC	<enter PIC>

The Calling Number Identification feature is assigned using the standard BRCS preconstructed features /LICNDA and /CPCOFA. If it is possible, request /CPCPFA for the Calling Number Identification feature, as it provides a clearer display of the CPN information.

The Redirecting Number Delivery (RND) feature is assigned using the preconstructed RND feature, /RND. These features are assigned to the user in View 23.8, Field 109.

DN2 Translations (Note: DSL information was built with DN1)

Fields that must be populated on Screens 1, 2, 3, and 4:

1	DSL TN	<C plus second Telephone number>
9	ASSOC	<U>
11	OE	<enter OE and type>
28	USPID	<enter value>
29	MAXB CHL	<2>
30	ACT USER	<Y>

Fields that must be populated on Screens 4, 5, and 6:

34	CKT TN	<enter TN>
35	CKT LCC	<enter LCC>
36	CKT RAX	<enter RAX value>
41	TERMTYP	<TYPEA>
42	DISPLAY	<Y>
46	CSV	<1>
47	CSV CHL	<ANY>
49	CSV LIMIT	<1>
55	CSD	<2>
56	CSD CHL	<ANY>
58	CSD LIMIT	<2>
126	CPN SCRN	<Y>
91	PIC	<enter PIC>

The Calling Number Identification feature is assigned using the standard BRCS preconstructed features /LICNDA and /CPCOFA. If it is possible, request /CPCPFA for the Calling Number Identification feature, as it provides a clearer display of the CPN information.

The Redirecting Number Delivery (RND) feature is assigned using the preconstructed RND feature, /RND. These features are assigned to the user in View 23.8, Field 109.

Series Completion Feature Translations

The sample screens shown below illustrate the translations for alternate voice and data hunting on one main DSL and three DNs forming a linear series completion group. Voice hunting is provided using Series Completion (Field 87, SERHLN). Data hunting is provided with Call Forward Data Busy Line (/CFDBLAC).

The 5ESS limits the number of members of a series completion group to 16 DNs, and the number of lines forwarded using /CFDBLAC to the value specified on Screen 9, Field 176 (SIMINTRA). This value is currently set to 99 series completion groups, but can be changed.

```

5ESS SWITCH LABNSC1
SCREEN 1 OF 14          RECENT CHANGE  23.8
                        DSL/BRCS ASSIGNMENT
(*)1. DSL TN   C 2228700  SERVICES AND FEATURES  SCREENS
(*)4. MLHG_____  -----
(*)5. TERM_____  BRCS FEATURE LIST      6
    
```

H NI-1 BRI Provisioning

Lucent Technologies 5ESS Switch Translations

H-5

5ESS SWITCH LABNSC1

(*)6. DSL OE _____	BRCS FEATURE PARAMETERS	7 to 9
(*)9. ASSOC UCKT		4 & 5
	DELFEAT LIST	14
	DPKT	10
	DSL INFO	2
	ODB	11
	PPB1	c
	PPB2	13
	USER INFO	3

5ESS SWITCH LABNSC1

SCREEN 2 OF 14

	RECENT CHANGE	23.8
	DSL/BRCS ASSIGNMENT (DSL INFO)	
>11. OE I 00101209	25. CUT DGTS	2228
14. D ISCN 007096	26. ACSR GRP _____	
15. D SERV SX	27. DFLT SRV _____	
16. B1 SERV DMD		
17. B2 SERV DMD		
18. NT1 TYPE AULC		
19. PM GRP PMDEF		
20. DSL CLS STD		
21. RSTR MP N		
22. ACSR INH Y		
23. MDPKT 8		
24. MTERM 2		

H NI-1 BRI Provisioning

Lucent Technologies 5ESS Switch Translations

H-6

SCREEN 3 OF 14

5ESS SWITCH LABNSC1
RECENT CHANGE 23.8
DSL/BRCS ASSIGNMENT (USER INFO)

>28. USPID 0122287000
29. MAXB CHL1
30. ACT USERY
31. PPB1 USRN
32. PPB2 USRN
33. AGI _

SCREEN 4 OF 14

5ESS SWITCH LABNSC1
RECENT CHANGE 23.8
DSL/BRCS ASSIGNMENT (CKT)

>34. CKT TN	2228700	CIRCUIT VOICE (CSV)	CIRCUIT DATA (CSD)
35. CKT LCC	DSL	46. CSV 1	55. CSD 1
36. CKT RAX	1	47. CSV CHL ANY	56. CSD CHL ANY
37. CKT MLHG	_____	48. CSV ACO	57. CSD ACO _____
38. CKT TERM	_____	49. CSV LIMIT 1	58. CSD LIMIT 1
39. NEW TN	_____	50. CSV NBLIMIT _____	59. CSD NBLIMIT _____
40. CONFIG GRP	NI17507B	50. CSV NBLIMIT _____	60. K56 DNA _____
41. TERMTYP	TYPEA	51. SP DNA _____	61. K56 DNA QTY _____
42. DISPLAY	Y	52. SP DNA QTY _____	62. K64 DNA _____
43. EKTS	_____	53. AU DNA	63. K64 DNA QTY _____
44. CA	_____	54. AU DNA QTY	
45. CA QT	_____		

SCREEN 5 OF 14

5ESS SWITCH LABNSC1
RECENT CHANGE 23.8
DSL/BRCS ASSIGNMENT (CKT)

>64. TKS	72. SAR QTY__	82. BUSY MONITORN
65. TAUTON	73. SAR ORIGN	83. ATT MLHG_____
66. SHAREDN	74. SAR TERMN	84. RBV TGN_____
67. SAUTON	75. INCOMINGN	85. ERCO ASGNN
68. PRIVACYN	76. INTERCOMN	86. ERCO ACTN
69. ICPN	77. ORIG CWN	87. SERHLN2228701
70. SUSON	78. PPN	88. BCK LNKN
71. SUSTN	79. CA PREF	90. CIDIALALLOW
	80. AUTO HOLD	91. PIC_____
	81. ONE TOUCHN	92. PTC_____
		95. E911 PSAPN

H NI-1 BRI Provisioning

Lucent Technologies 5ESS Switch Translations

H-7

SCREEN 6 OF 14

5ESS SWITCH LABNSC1

RECENT CHANGE 23.8

DSL/BRCS ASSIGNMENT

>106. BFGN _____ 109. FEATURE LIST (FL)

A					A					A					A					
ROW	FEATURE	A	P	C	R	FEATURE	A	P	C	R	FEATURE	A	P	C	R	FEATURE	A	P	C	R
1	/LIDLXA	Y	_	N	N	10	_____	-	-	-	19	_____	-	-	-	28	_____	-	-	-
2	/CPCPFA	Y	_	N	N	11	_____	-	-	-	20	_____	-	-	-	29	_____	-	-	-
3	/CFDBLAC	Y	_	N	N	12	_____	-	-	-	21	_____	-	-	-	30	_____	-	-	-
4	_____	-	-	-	-	13	_____	-	-	-	22	_____	-	-	-	31	_____	-	-	-
5	_____	-	-	-	-	14	_____	-	-	-	23	_____	-	-	-	32	_____	-	-	-
6	_____	-	-	-	-	15	_____	-	-	-	24	_____	-	-	-	33	_____	-	-	-
7	_____	-	-	-	-	16	_____	-	-	-	25	_____	-	-	-	34	_____	-	-	-
8	_____	-	-	-	-	17	_____	-	-	-	26	_____	-	-	-	35	_____	-	-	-
9	_____	-	-	-	-	18	_____	-	-	-	27	_____	-	-	-	36	_____	-	-	-

SCREEN 7 OF 14

5ESS SWITCH LABNSC1

RECENT CHANGE 23.8

DSL/BRCS ASSIGNMENT (HIGH RUNNER FEATURE PARAMETERS)

>134.	TG:GRPID	0	146.	ACSR GRPNM	_____	158.	QALWD	_____	-
135.	MOH ALW	_____	147.	EDS:GRPNM	_____	159.	PRIORITY Q	_____	-
136.	IDP NAME	_____	148.	BCLID GR	_____	160.	ARSSI	_____	-
137.	DPAT CAT	0	149.	PFA:VGRPN	_____	161.	DIALPLN	_____	-
138.	ICR SFG	0	150.	PFA:DGRPNM	_____	162.	ALWMDR	_____	-
139.	SC1NAME	_____	151.	ATH:VGRPNM	_____	163.	ACSR PINREQ	_____	-
140.	SC1S	_____	152.	ATH:DGRPNM	_____	164.	DRING	_____	-
141.	SC2NAME	_____	153.	MDR:GRPNM	_____	165.	DCW DRING	_____	-
142.	SC2S	_____	154.	ACCT:GRPNM	_____	166.	CWO DRING	_____	-
143.	CPUO:SELQ1	0	155.	ARS:VGRPNM	_____	167.	MWY DRING	_____	-
144.	CPUO:SELQ2	0	156.	ARS:DGRPNM	_____				
145.	CPUT:TPREDQ	0	157.	FRL	_____				

5ESS SWITCH LABNSC1

RECENT CHANGE 23.8

SCREEN 8 OF 14

DSL/BRCS ASSIGNMENT (HIGH RUNNER FEATURE PARAMETERS)

>172. MESSAGE SERVICE (MSS) 175. MW:DCNDN _____

ROW	FEATURE	GRPNM
1	_____	_____
2	_____	_____
3	_____	_____
4	_____	_____

SCREEN 9 OF 14

5ESS SWITCH LABNSC1

RECENT CHANGE 23.8

DSL/BRCS ASSIGNMENT (HIGH RUNNER FEATURE PARAMETERS)

>176. CALL FORWARDING FEATURE PARAMETERS (CF)

ROW	FEATURE	FWD TO DN	TIMEOUT	BSRING	SIMINTER	SIMINTRA
1	/CFDBLAC2228701		0	N	1	99
2	_____		0	-	0	0
3	_____		0	-	0	0
4	_____		0	-	0	0
5	_____		0	-	0	0
6	_____		0	-	0	0

SCREEN 10 OF 14

5ESS SWITCH LABNSC1

RECENT CHANGE 23.8

DSL/BRCS ASSIGNMENT (DPKT)

>183. DPKT TN	_____	192. IECP DNIC	_____	198. H PVC LCN	_____
184. LCC	_____	193. PB GRP	_____	199. L IN LCN	_____
185. RAX	_____	194. NOTIF	NO	200. H IN LCN	_____
186. MLHG	_____	195. ICP	N	201. L 2W LCN	_____
187. TERM	_____	196. HUNT NOTIF	_____	202. H 2W LCN	_____
188. LNR HNT TN	_____	197. TCID	_____	203. L OUT LCN	_____
190. CHL SEL	N			204. H OUT LCN	_____
191. NEW TN	_____			206. PMDR GRP	_____
				207. PMDR ACT	_____
				208. DNA	_____
				209. DNA QTY	_____

SCREEN 11 OF 14

5ESS SWITCH LABNSC

RECENT CHANGE 23.8

DSL/BRCS ASSIGNMENT (ODB)

>210. ODB TN	_____	222. RATE	_____	234. L IN LCN	_____
211. LCC	_____	223. N2	_____	235. H IN LCN	_____
212. RAX	0	224. T1	_____	236. L 2W LCN	_____
213. MLHG	_____	225. T3	_____	237. H 2W LCN	_____
214. TERM	_____	226. WNDSZ	_____	238. L OUT LCN	_____
215. LNR HNT TN	_____	227. NEW TN	_____	239. H OUT LCN	_____
216. HUNT DEACT	_____	228. IECP DNIC	_____	240. BUSY LIMIT	_____
217. CHL SEL	N	229. PB GRP	_____	241. PMDR GRP	_____
218. ISCN1	_____	230. NOTIF	_____	242. PMDR ACT	_____
219. ISCN2	_____	231. T3XX	0	243. DNA	_____
220. BAND	0	232. ICP	N	244. DNA QTY	_____
221. ODB	_____	233. HUNT NOTIF	_____		

H NI-1 BRI Provisioning

Lucent Technologies 5ESS Switch Translations

H-9

SCREEN 12 OF 14

5ESS SWITCH LABNSC1

RECENT CHANGE 23.8

DSL/BRCS ASSIGNMENT (PPB1)

>245. PPB1 TN	_____	254. RATE	_____	264. H PVC LCN	_____
246. LCC	_____	255. N2	_____	265. L IN LCN	_____
247. RAX	0	256. T1	_____	266. H IN LCN	_____
248. MLHG	_____	257. T3	_____	267. L 2W LCN	_____
249. TERM	_____	258. WNDSZ	_____	268. H 2W LCN	_____
250. LNR HNT TN	_____	259. NEW TN	_____	239. H OUT LCN	_____
251. HUNT DEACT	_____	260. IECP DNIC	_____	269. L OUT LCN	_____
252. CHL SEL	N	261. PB GRP	_____	270. H OUT LCN	_____
253. ISCN	_____	262. ICP	N	271. BUSY LIMIT	_____
		263. HUNT NOTIF	_____	272. PMDR GRP	_____
				273. PMDR AC	_____

SCREEN 13 OF 14

5ESS SWITCH LABNSC1

RECENT CHANGE 23.8

DSL/BRCS ASSIGNMENT (PPB2)

>274. PPB2 TN	_____	283. RATE	_____	293. H PVC LCN	_____
275. LCC	_____	284. N2	_____	294. L IN LCN	_____
276. RAX	0	285. T1	_____	295. H IN LCN	_____
277. MLHG	_____	286. T3	_____	296. L 2W LCN	_____
278. TERM	_____	287. WNDSZ	_____	297. H 2W LCN	_____
279. LNR HNT TN	_____	288. NEW TN	_____	298. L OUT LCN	_____
280. HUNT DEACT	_____	289. IECP DNIC	_____	299. H OUT LCN	_____
281. CHL SEL	N	290. PB GRP	_____	300. BUSY LIMIT	_____
282. ISCN	_____	291. ICP	N	301. PMDR GRP	_____
		292. HUNT NOTIF	_____	302. PMDR ACT	_____

SCREEN 14 OF 14

5ESS SWITCH LABNSC1

RECENT CHANGE 23.8

DSL/BRCS ASSIGNMENT

WARNING: These fields delete features currently on the view or in a BFG.
Deletion of a feature in BFG may invoke BFG reselection.

303. DELFEAT

ROW	FEATURE
1	_____
2	_____
3	_____

No Messages

H NI-1 BRI Provisioning

Lucent Technologies 5ESS Switch Translations

H-10

SCREEN 1 OF 14

5ESS SWITCH LABNSC1

RECENT CHANGE 23.8

DSL/BRCS ASSIGNMENT

			SERVICES AND FEATURES	SCREENS
(*)1. DSL	TN C	2228701	-----	-----
(*)4. MLHG	_____			
(*)5. TERM	_____		BRCS FEATURE LIST	6
(*)6. DSL	_____		BRCS FEATURE PARAMETERS	7 to 9
(*)9. ASSOC	U	CKT		4 & 5
			DELFEAT LIST	14
			DPKT	10
			DSL INFO	2
			ODB	11
			PPB1	12
			PPB2	13
			USER INFO	3

SCREEN 2 OF 14

5ESS SWITCH LABNSC1

RECENT CHANGE 23.8

DSL/BRCS ASSIGNMENT (DSL INFO)

>11. OE I	00101209	25. CUT DGTS	2228
14. D ISCN	007096	26. ACSR GRP	_____
15. D SERV	SX	27. DFLT SRV	_____
16. B1 SERV	DMD		
17. B2 SERV	DMD		
18. NT1 TYPE	AULC		
19. PM GRP	PMDEF		
20. DSL CLS			
21. RSTR MP	N		
22. ACSR INH	Y		
23. MDPKT	8		
24. MTERM	2		

SCREEN 3 OF 14

5ESS SWITCH LABNSC1

RECENT CHANGE 23.8

DSL/BRCS ASSIGNMENT (USER INFO)

>28. USPID0122287010
29. MAXB CHL1
30. ACT USERY
31. PPB1 USRN
32. PPB2 USRN
33. AGI _____

H NI-1 BRI Provisioning

Lucent Technologies 5ESS Switch Translations

H-11

SCREEN 4 OF 14

5ESS SWITCH LABNSC1
 RECENT CHANGE 23.8
 DSL/BRCS ASSIGNMENT (CKT)

>34. CKT TN	2228701	CIRCUIT VOICE	(CSV)	CIRCUIT DATA	(CSD)
35. CKT LCC	DSL	46. CSV	1	55. CSD	1
36. CKT RAX	1	47. CSV CHL	ANY	56. CSD CHL	ANY
37. CKT MLHG	_____	48. CSV ACO	_____	57. CSD ACO	_____
38. CKT TERM	_____	49. CSV LIMIT	1	58. CSD LIMIT	1
39. NEW TN	_____	50. CSV NBLIMIT	_____	59. CSD NBLIMIT	_____
40. CONFIG GRP	NI17507A	51. SP DNA	_____	60. K56 DNA	_____
41. TERMTYP	TYPEA	52. SP DNA QTY	_____	61. K56 DNA QTY	_____
42. DISPLAY	Y	53. AU DNA	_____	62. K64 DNA	_____
43. EKTS	_____	54. AU DNA	_____	63. K64 DNA QTY	_____
44. CA	_____				
45. CA QTY	_____				

SCREEN 5 OF 14

5ESS SWITCH LABNSC1
 RECENT CHANGE 23.8
 DSL/BRCS ASSIGNMENT (CKT)

>64. TSKN	72. SAR QTY__	82. BUSY MONITORN
65. TAUTON	73. SAR ORIGN	83. ATT MLHG_____
66. SHAREDN	74. SAR TERMN	84. RBV TGN_____
67. SAUTON	75. INCOMINGN	85. ERCO ASGNN
68. PRIVACYN	76. INTERCOMN	86. ERCO ACTN2228703
69. ICPN	77. ORIG CWN	87. SERHLN
70. SUSON	78. PPN	88. BCK LNKY
71. SUSTN	79. CA PREFI	89. ACD POS NUM_____
	80. AUTO HOLDN	90. CIDIALALLOW
	81. ONE TOUCHN	91. PIC_____
		92. PTC_____
		95. E911 PSAPN

SCREEN 6 OF 14

5ESS SWITCH LABNSC1
 RECENT CHANGE 23.8
 DSL/BRCS ASSIGNMENT

>106. BFGN _____ 109. FEATURE LIST (FL)

ROW	FEATURE	A	P	C	R	FEATURE	A	P	C	R	FEATURE	A	P	C	R	FEATURE	A	P	C	R	
1	/CPCPFA	Y	_	N	N	10	_____	-	-	-	19	_____	-	-	-	28	_____	-	-	-	-
2	/LIDLXA	Y	_	N	N	11	_____	-	-	-	20	_____	-	-	-	29	_____	-	-	-	-
3	/CFDBLAC	Y	_	N	N	12	_____	-	-	-	21	_____	-	-	-	30	_____	-	-	-	-
4	_____	-	-	-	-	13	_____	-	-	-	22	_____	-	-	-	31	_____	-	-	-	-
5	_____	-	-	-	-	14	_____	-	-	-	23	_____	-	-	-	32	_____	-	-	-	-
6	_____	-	-	-	-	15	_____	-	-	-	24	_____	-	-	-	33	_____	-	-	-	-
7	_____	-	-	-	-	16	_____	-	-	-	25	_____	-	-	-	34	_____	-	-	-	-
8	_____	-	-	-	-	17	_____	-	-	-	26	_____	-	-	-	35	_____	-	-	-	-
9	_____	-	-	-	-	18	_____	-	-	-	27	_____	-	-	-	36	_____	-	-	-	-

H NI-1 BRI Provisioning

Lucent Technologies 5ESS Switch Translations

H-12

SCREEN 7 OF 14

5ESS SWITCH LABNSC1

RECENT CHANGE 23.8

DSL/BRCS ASSIGNMENT (HIGH RUNNER FEATURE PARAMETERS)

>134. TG:GRPID	0	146. ACSR GRPNM	_____	158. QALWD	_____
135. MOH ALW	_____	147. EDS:GRPNM	_____	159. PRIORITY Q	_____
136. IDP NAME	_____	148. BCLID GRP	_____	160. ARSSI	_____
137. DPAT CAT	0	149. PFA:VGRPNM	_____	161. DIALPLN	_____
138. ICR SFG	0	150. PFA:DGRPNM	_____	162. ALWMDR	_____
139. SC1NAME	_____	151. ATH:VGRPNM	_____	163. ACSR PINREQ	_____
140. SC1S	_____	152. ATH:DGRPNM	_____	164. DRING	_____
141. SC2NAME	_____	153. MDR:GRPNM	_____	165. DCW DRING	_____
142. SC2S	_____	154. ACCT:GRPNM	_____	166. CWO DRING	_____
143. CPUO:SELQ1	0	156. ARS:DGRPNM	_____	167. MWY DRING	_____
144. CPUO:SELQ2	0	157. FRL	_____		
145. CPUT:TPREDQ	0				

SCREEN 8 OF 14

5ESS SWITCH LABNSC1

RECENT CHANGE 23.8

DSL/BRCS ASSIGNMENT (HIGH RUNNER FEATURE PARAMETERS)

>172. MESSAGE SERVICE (MSS) 175. MW:DCNDN _____

ROW	FEATURE	GRPNM
1	_____	_____
2	_____	_____
3	_____	_____
4	_____	_____

SCREEN 9 OF 14

5ESS SWITCH LABNSC1

RECENT CHANGE 23.8

DSL/BRCS ASSIGNMENT (HIGH RUNNER FEATURE PARAMETERS)

>176. CALL FORWARDING FEATURE PARAMETERS (CF)

ROW	FEATURE	FWD TO DN	TIMEOUT	BSRING	SIMINTER	SIMINTRA
1	/CFDBLAC2228703		0	N	1	99
2	_____		0	-	0	0
3	_____		0	-	0	0
4	_____		0	-	0	0
5	_____		0	-	0	0
6	_____		0	-	0	0

SCREEN 1 OF 14 5ESS SWITCH LABNSC1
RECENT CHANGE 23.8
DSL/BRCS ASSIGNMENT

(*)	1.	DSL	TN	C	2228703	SERVICES AND FEATURES	SCREENS
(*)	4.	MLHG	_____			-----	-----
(*)	5.	TERM	_____			BRCS FEATURE LIST	6
(*)	6.	DSL OE	_____			BRCS FEATURE PARAMETERS	7 to 9
(*)	9.	ASSOC	U		CKT		4 & 5
						DELFEAT LIST	14
						DPKT	10
						DSL INFO	2
						ODB	11
						PPB1	12
						PPB2	13
						USER INFO	3

SCREEN 2 OF 14 5ESS SWITCH LABNSC1
RECENT CHANGE 23.8
DSL/BRCS ASSIGNMENT (DSL INFO)

>	11.	OE	I	00101221	25.	CUT DGTS	2228
	14.	D	ISCN	007105	26.	ACSR GRP	_____
	15.	D	SERV	SX	27.	DFLT SRV	_____
	16.	B1	SERV	DMD			
	17.	B2	SERV	DMD			
	18.	NT1	TYPE	TLC			
	19.	PM	GRP	_____			
	20.	DSL	CLS	STD			
	21.	RSTR	MP	N			
	22.	ACSR	INH	Y			
	23.	MDPKT		8			
	24.	MTERM		2			

SCREEN 3 OF 14 5ESS SWITCH LABNSC1
RECENT CHANGE 23.8
DSL/BRCS ASSIGNMENT (USER INFO)

>	28.	USPID0122287030					
	29.	MAXB	CHL1				
	30.	ACT	USERY				
	31.	PPB1	USRN				
	32.	PPB2	USRN				
	33.	AGI	_____				

H NI-1 BRI Provisioning

Lucent Technologies 5ESS Switch Translations

H-14

SCREEN 4 OF 14

5ESS SWITCH LABNSC1
RECENT CHANGE 23.8
DSL/BRCS ASSIGNMENT (CKT)

>34. CKT TN	2228703	CIRCUIT VOICE	(CSV)	CIRCUIT DATA	(CSD)
35. CKT LCC	DSL	46. CSV	1	55. CSD	1
36. CKT RAX	1	47. CSV CHL	ANY	56. CSD CHL	ANY
37. CKT MLHG	_____	48. CSV ACO	_____	57. CSD ACO	_____
38. CKT TERM	_____	49. CSV LIMIT	1	58. CSD LIMIT	1
39. NEW TN	_____	50. CSV NBLIMIT	_____	59. CSD NBLIMIT	_____
40. CONFIG GRP	_____	51. SP DNA	_____	60. K56 DNA	_____
41. TERMTYP	TYPEA	52. SP DNA QTY	_____	61. K56 DNA QTY	_____
42. DISPLAY	Y	53. AU DNA	_____	62. K64 DNA	_____
43. EKTS	_____	54. AU DNA	_____	63. K64 DNA QTY	_____
44. CA	_____				
45. CA QTY	_____				

SCREEN 5 OF 14

5ESS SWITCH LABNSC1
RECENT CHANGE 23.8
DSL/BRCS ASSIGNMENT (CKT)

>64. TKS	72. SAR QTY__	82. BUSY MONITRN
65. TAUTON	73. SAR ORIGN	83. ATT MLHG__
66. SHAREDN	74. SAR TERMN	84. RBV TGN__
67. SAUTON	75. INCOMINGN	85. ERCO ASGNN
68. PRIVACYN	76. INTERCOMN	86. ERCO ACTN
69. ICPN	77. ORIG CWN	87. SERHLN2228704
70. SUSON	78. PPN	88. BCK LNKY
71. SUSTN	79. CA PREFI	89. ACD POS NUM__
	80. AUTO HOLDN	90. CIDIALALLOW
	81. ONE TOUCHN	91. PIC__
		92. PTC__
		95. E911 PSAPN

H NI-1 BRI Provisioning
 Lucent Technologies 5ESS Switch Translations

H-15

SCREEN 6 OF 14

5ESS SWITCH LABNSC1

RECENT CHANGE 23.8

DSL/BRCS ASSIGNMENT

>106. BFGN _____ 109. FEATURE LIST (FL)

A					A					A					A						
ROW	FEATURE	A	P	C	R	FEATURE	A	P	C	R	FEATURE	A	P	C	R	FEATURE	A	P	C	R	
1	/CPCPFA	Y	_	N	N	10	_____	-	-	-	19	_____	-	-	-	28	_____	-	-	-	-
2	/LIDLXA	Y	_	N	N	11	_____	-	-	-	20	_____	-	-	-	29	_____	-	-	-	-
3	/CFDBLAC	Y	_	N	N	12	_____	-	-	-	21	_____	-	-	-	30	_____	-	-	-	-
4	_____	-	-	-	-	13	_____	-	-	-	22	_____	-	-	-	31	_____	-	-	-	-
5	_____	-	-	-	-	14	_____	-	-	-	23	_____	-	-	-	32	_____	-	-	-	-
6	_____	-	-	-	-	15	_____	-	-	-	24	_____	-	-	-	33	_____	-	-	-	-
7	_____	-	-	-	-	16	_____	-	-	-	25	_____	-	-	-	34	_____	-	-	-	-
8	_____	-	-	-	-	17	_____	-	-	-	26	_____	-	-	-	35	_____	-	-	-	-
9	_____	-	-	-	-	18	_____	-	-	-	27	_____	-	-	-	36	_____	-	-	-	-

SCREEN 7 OF 14

5ESS SWITCH LABNSC1

RECENT CHANGE 23.8

DSL/BRCS ASSIGNMENT (HIGH RUNNER FEATURE PARAMETERS)

>134.	TG:GRPID	0	146.	ACSR GRPNM	_____	158.	QALWD	_____
135.	MOH ALW	_____	147.	EDS:GRPNM	_____	159.	PRIORITY Q	_____
136.	IDP NAME	_____	148.	BCLID GRP	_____	160.	ARSSI	_____
137.	DPAT CAT	0	149.	PFA:VGRPNM	_____	161.	DIALPLN	_____
138.	ICR SFG	0	150.	PFA:DGRPNM	_____	162.	ALWMDR	_____
139.	SC1NAME	_____	151.	ATH:VGRPNM	_____	163.	ACSR PINREQ	_____
140.	SC1S	_____	152.	ATH:DGRPNM	_____	164.	DRING	_____
141.	SC2NAME	_____	153.	MDR:GRPNM	_____	165.	DCW DRING	_____
142.	SC2S	_____	154.	ACCT:GRPNM	_____	166.	CWO DRING	_____
143.	CPUO:SELQ1	0	156.	ARS:DGRPNM	_____	167.	MWY DRING	_____
144.	CPUO:SELQ2	0	157.	FRL	_____			
145.	CPUT:TPREDQ	0						

SCREEN 8 OF 14

5ESS SWITCH LABNSC1

RECENT CHANGE 23.8

DSL/BRCS ASSIGNMENT (HIGH RUNNER FEATURE PARAMETERS)

>172. MESSAGE SERVICE (MSS) 175. MW:DCNDN _____

ROW	FEATURE	GRPNM
1	_____	_____
2	_____	_____
3	_____	_____
4	_____	_____

SCREEN 9 OF 14 5ESS SWITCH LABNSC1
 RECENT CHANGE 23.8
 DSL/BRCS ASSIGNMENT (HIGH RUNNER FEATURE PARAMETERS)

>176. CALL FORWARDING FEATURE PARAMETERS (CF)

ROW	FEATURE	FWD TO DN	TIMEOUT	BSRING	SIMINTER	SIMINTRA
1	/CFDBLAC2228704		0	Y	1	99
2	_____		0	-	0	0
3	_____		0	-	0	0
4	_____		0	-	0	0
5	_____		0	-	0	0
6	_____		0	-	0	0

SCREEN 1 OF 14 5ESS SWITCH LABNSC1
 RECENT CHANGE 23.8
 DSL/BRCS ASSIGNMENT

(*)	Feature	TN	C	2228704	SERVICES AND FEATURES	SCREENS
(*)1.	DSL	_____				
(*)4.	MLHG	_____			-----	-----
(*)5.	TERM	_____			BRCS FEATURE LIST	6
(*)6.	DSL OE	_____			BRCS FEATURE PARAMETERS	7 to 9
(*)9.	ASSOC	U		CKT		4 & 5
					DELFEAT LIST	14
					DPKT	10
					DSL INFO	2
					ODB	11
					PPB1	12
					PPB2	13
					USER INFO	3

SCREEN 2 OF 14 5ESS SWITCH LABNSC1
 RECENT CHANGE 23.8
 DSL/BRCS ASSIGNMENT (DSL INFO)

>11.	OE	I	00101221	25.	CUT DGTS	2228
14.	D	ISCN	007105	26.	ACSR GRP	_____
15.	D	SERV	SX	27.	DFLT SRV	_____
16.	B1	SERV	DMD			
17.	B2	SERV	DMD			
18.	NT1	TYPE	TLC			
19.	PM	GRP	_____			
20.	DSL	CLS	STD			
21.	RSTR	MP	N			
22.	ACSR	INH	Y			
23.	MDPKT		8			
24.	MTERM		2			

H NI-1 BRI Provisioning

Lucent Technologies 5ESS Switch Translations

H-17

SCREEN 3 OF 14

5ESS SWITCH LABNSC1

RECENT CHANGE 23.8

DSL/BRCS ASSIGNMENT (USER INFO)

- >28. USPID0122287040
- 29. MAXB CHL1
- 30. ACT USERY
- 31. PPB1 USRN
- 32. PPB2 USRN
- 33. AGI_

SCREEN 4 OF 14

5ESS SWITCH LABNSC1

RECENT CHANGE 23.8

DSL/BRCS ASSIGNMENT (CKT)

>34. CKT TN	2228704	CIRCUIT VOICE (CSV)	CIRCUIT DATA	(CSD)
35. CKT LCC	DSL	46. CSV	1	55. CSD
36. CKT RAX	1	47. CSV CHL	ANY	56. CSD CHL
37. CKT MLHG	_____	48. CSV ACO	_____	57. CSD ACO
38. CKT TERM	_____	49. CSV LIMIT	1	58. CSD LIMIT
39. NEW TN	_____	50. CSV NBLIMIT	_____	59. CSD NBLIMIT
40. CONFIG GRP	_____	51. SP DNA	_____	60. K56 DNA
41. TERMTYP	TYPEA	52. SP DNA QTY	_____	61. K56 DNA QTY
42. DISPLAY	Y	53. AU DNA	_____	62. K64 DNA
43. EKTS	_____	54. AU DNA	_____	63. K64 DNA QTY
44. CA	_____			
45. CA QTY	_____			

SCREEN 5 OF 14

5ESS SWITCH LABNSC1

RECENT CHANGE 23.8

DSL/BRCS ASSIGNMENT (CKT)

>64. TKS	N	72. SAR QTY	___	82. BUSY MONITOR	N
65. TAUTO	N	73. SAR ORIG	N	83. ATT MLHG	___
66. SHARED	N	74. SAR TERM	N	84. RBV TGN	___
67. SAUTO	N	75. INCOMING	N	85. ERCO ASGN	N
68. PRIVACY	N	76. INTERCOM	N	86. ERCO ACT	N
69. ICP	N	77. ORIG CW	N	87. SERHLN	___
70. SUSO	N	78. PP	N	88. BCK LNK	Y
71. SUST	N	79. CA PREF	I	89. ACD POS NUM	___
		80. AUTO HOLD	N	90. CIDIAL	ALLOW
		81. ONE TOUCH	N	91. PIC	___
				92. PTC	___
				95. E911 PSAP	N

SCREEN 6 OF 14

5ESS SWITCH LABNSC1

RECENT CHANGE 23.8

DSL/BRCS ASSIGNMENT

>106. BFGN _____ 109. FEATURE LIST (FL)

	A				A				A				A							
ROW	FEATURE	A	P	C	R	FEATURE	A	P	C	R	FEATURE	A	P	C	R	FEATURE	A	P	C	R
1	/CPCPFA	Y	_	N	N	10	_____	_____	_____	_____	19	_____	_____	_____	_____	28	_____	_____	_____	_____
2	/LIDLXA	Y	_	N	N	11	_____	_____	_____	_____	20	_____	_____	_____	_____	29	_____	_____	_____	_____
3	_____	_____	_____	_____	_____	12	_____	_____	_____	_____	21	_____	_____	_____	_____	30	_____	_____	_____	_____
4	_____	_____	_____	_____	_____	13	_____	_____	_____	_____	22	_____	_____	_____	_____	31	_____	_____	_____	_____
5	_____	_____	_____	_____	_____	14	_____	_____	_____	_____	23	_____	_____	_____	_____	32	_____	_____	_____	_____
6	_____	_____	_____	_____	_____	15	_____	_____	_____	_____	24	_____	_____	_____	_____	33	_____	_____	_____	_____
7	_____	_____	_____	_____	_____	16	_____	_____	_____	_____	25	_____	_____	_____	_____	34	_____	_____	_____	_____
8	_____	_____	_____	_____	_____	17	_____	_____	_____	_____	26	_____	_____	_____	_____	35	_____	_____	_____	_____
9	_____	_____	_____	_____	_____	18	_____	_____	_____	_____	27	_____	_____	_____	_____	36	_____	_____	_____	_____

SCREEN 7 OF 14

5ESS SWITCH LABNSC1

RECENT CHANGE 23.8

DSL/BRCS ASSIGNMENT (HIGH RUNNER FEATURE
 PARAMETERS)

>134. TG:GRPID	0	146. ACSR GRPNM	_____	158. QALWD	_____
135. MOH ALW	_____	147. EDS:GRPNM	_____	159. PRIORITY Q	_____
136. IDP NAME	_____	148. BCLID GRP	_____	160. ARSSI	_____
137. DPAT CAT	0	149. PFA:VGRPNM	_____	161. DIALPLN	_____
138. ICR SFG	0	150. PFA:DGRPNM	_____	162. ALWMDR	_____
139. SC1NAME	_____	151. ATH:VGRPNM	_____	163. ACSR PINREQ	_____
140. SC1S	_____	152. ATH:DGRPNM	_____	164. DRING	_____
141. SC2NAME	_____	153. MDR:GRPNM	_____	165. DCW DRING	_____
142. SC2S	_____	154. ACCT:GRPNM	_____	166. CWO DRING	_____
143. CPUO:SELQ1	0	155. ARS:VGRPNM	_____	167. MWY DRING	_____
144. CPUO:SELQ2	0	156. ARS:DGRPNM	_____		
145. CPUT:TPREDQ	0	157. FRL	_____		

H NI-1 BRI Provisioning

Lucent Technologies 5ESS Switch Translations

H-19

SCREEN 8 OF 14 5ESS SWITCH LABNSC1
 RECENT CHANGE 23.8
 DSL/BRCs ASSIGNMENT (HIGH RUNNER FEATURE PARAMETERS)
>172. MESSAGE SERVICE (MSS) 175. MW:DCNDN _____

ROW	FEATURE	GRPNM
1	_____	_____
2	_____	_____
3	_____	_____
4	_____	_____

SCREEN 9 OF 14 5ESS SWITCH LABNSC1
 RECENT CHANGE 23.8
 DSL/BRCs ASSIGNMENT (HIGH RUNNER FEATURE PARAMETERS)
>176. CALL FORWARDING FEATURE PARAMETERS (CF)

ROW	FEATURE	FWD TO DN	TIMEOUT	BSRING	SIMINTER	SIMINTRA
1	_____		0	—	0	0
2	_____		0	—	0	0
3	_____		0	—	0	0
4	_____		0	—	0	0
5	_____		0	—	0	0
6	_____		0	—	0	0

Northern Telecom DMS-100 Switch Translations

For the Northern Telecom DMS-100 switch, Capability Package "S" includes alternate voice/circuit-switched data on two B-channels. It also supports Calling Number Identification on data and voice connections. Please note that the assignment of two DNs is required for this package.

The DMS-100 switch also allows alternate voice and data hunting on one DN through the Multiline Hunt Group feature.

ISDN Capability Package "S"

The information listed below provides the DN translations that define Capability Package "S," and the commands that must be executed.

ISDN Ordering Code: Capability S

Provision DN1 using the following translations

Define a new Logical Terminal Identifier (LTID) using the SLT command:

```
SONUMBER    <<cr> or $>
LTID        <enter identifier value>
FUNCTION     <ADD>
LTCLASS     <BRAFS>
CS          <Y>
PS          <N>
MAXKEYS     <64>
TEI_TYPE    <DTEI>
ABS         <NOPMD>
ABS         <$>
EKTS       <N>
SPIDSFX option
  SPID_SUFFIX <enter spid suffix value>
PVC option
  VERSION    <FUNCTIONAL>
  ISSUE     <2>
```

Associate new DN with LTID using the NEW command:

SONUMBER <<cr> or \$>
DN <enter DN>
LCC <ISDNKSET>
GROUP <enter group name>
SUBGRP <enter subgrp value>
NCOS <enter ncos value>
SNPA <enter NXX value>
KEY <1>
RINGING <Y>
LATANAME <enter value>
LTG <enter value>
LEN_OR_LTID <enter assigned value>

DMS-100 normally delivers the Calling Party Number and the Redirecting Number, if available.

Attach LTIDs to LEN using the SLT command:

SONUMBER <<cr> or \$>
LTID <enter value>
FUNCTION <ATT>
LEN <enter LEN to which LTID will be attached>

Provision DN2 using the following translations

Define a new Logical Terminal Identifier (LTID) using the SLT command:

SONUMBER<<cr> or \$>
LTID <enter identifier value>
FUNCTION <ADD>
LTCLASS <BRAFS>
CS <Y>
PS <N>
MAXKEYS <64>
TEI_TYPE <DTEI>
ABS <NOPMD>
ABS <\$>
EKTS <N>
SPIDSFX option

SPID_SUFFIX <enter spid suffix value>

PVC option

VERSION <FUNCTIONAL>

ISSUE <2>

Associate new DN with LTID using the NEW command:

SONUMBER <<cr> or \$>

DN <enter DN>

LCC <ISDNKSET>

GROUP <enter group name>

SUBGRP <enter subgrp value>

NCOS <enter ncos value>

SNPA <enter NXX value>

KEY <1>

RINGING <Y>

LATANAME <enter value>

LTG <enter value>

LEN_OR_LTID <enter assigned value>

DMS-100 normally delivers the Calling Party Number and the Redirecting Number, if available.

Attach LTIDs to LEN using the SLT command:

SONUMBER <<cr> or \$>

LTID <enter value>

FUNCTION <ATT>

LEN <enter LEN to which LTID will be attached>

Multiline Hunt Group Feature Translations

The sample screens shown below illustrate the translations for alternate voice and data hunting on three Digital Subscriber Lines (DSLs) and six Directory Numbers (DNs) forming a circular hunt group. This hunting is provided using the Multiline Hunt Group feature.

The screens shown in this section are examples, DNs shown on these screens should be replaced with applicable data.

H NI-1 BRI Provisioning
Northern Telecom DMS-100 Switch Translations

H-23

DN: 2257141
TYPE: PILOT OF DNH HUNT GROUP
SNPA: 201SIG: N/A LNATTIDX: N/A
HUNT GROUP: 22 HUNT MEMBER: O
LTID: PSATS 141
LTCLASS: BRAFS
LINE CLASS CODE: ISDNKSET
KEY: 1
CUSTGRP: MDCSCA SUBGRP: O NCOS: O RING: Y
OPTIONS:
SFC
6ROUP OPTIONS:
CIR RCVD
MEMBER INFO:
1 2257146
2 2257145
3 2257144
4 2257143
5 2257142

QLT PSATS 141

LTID: PSATS 141
SNPA: 201
DIRECTORY NUMBER: 2257141
LT GROUP NO: 13
LTCLASS: BRAFS DEFAULT LOGICAL TERMINAL: N
EKTS: N CACH: N
BEARER SERVICE RESTRICTIONS: NOPMD
CS: Y PS: N
VERSION: FUNCTIONAL ISSUE: 2
SPID-SUFFIX: 01
LEN: HOST 01 1 10 01 TEI: DYNAMIC
CUSTGRP: MDCSCA SUBGRP: O NCOS: ORING: Y
LINE CLASS CODE: ISDNKSET
MAXKEYS: 64
DN IS ASSIGNED AS A DNH HUNT PILOT.
HUNT GROUP: 22 HUNT MEMBER: O
OPTIONS:
SFC

KEY	DN	
---	--	
1	DN	2257141

KEY	FEATURE
---	-----
	NONE

GROUP OPTIONS:

CIR RCVD

MEMBER INFO:

1	2257146
2	2257145
3	2257144
4	2257143
5	2257142

H NI-1 BRI Provisioning
Northern Telecom DMS-100 Switch Translations

H-25

QLT PSATS 142

LTID: PSATS 142
SNPA: 201
DIRECTORY NUMBER: 2257142
LT GROUP NO: 13
LTCLASS: BRAFS DEFAULT LOGICAL TERMINAL: N
EKTS: N CACH: N
BEARER SERVICE RESTRICTIONS: NOPMD
CS: Y PS: N
VERSION: FUNCTIONAL ISSUE: 2
SPID-SUFFIX: 01
LEN: HOST 01 1 10 02 TEI: DYNAMIC
CUSTGRP: MDCSCA SUBGRP: O NCOS: O RING: Y
LINE CLASS CODE: ISDNKSET
MAXKEYS: 64
DN IS ASSIGNED AS A DNH HUNT MEMBER (NOT PILOT).
HUNT GROUP: 22 HUNT MEMBER: 5
OPTIONS:
SFC

KEY	DN	
---	--	
1	DN	2257142

KEY FEATURE
--- -----
NONE

PILOT DN: 2257141
GROUP OPTIONS:
CIR RCVD

DN: 2257143
TYPE: MEMBER OF DNH HUNT GROUP
SNPA: 201 SIG: N/A LNATTIDX: N/A
HUNT GROUP: 22 HUNT MEMBER: 4
LTID: PSATS 143
LTCLASS: BRAFS
LINE CLASS CODE: ISDNKSET
KEY: 1
CUSTGRP: MDCSCA SUBGRP: O NCOS: O RING: Y
OPTIONS:
SFC
PILOT DN: 2257141
GROUP OPTIONS:
CIR RCVD

LTID: PSATS 143
SNPA: 201
DIRECTORY NUMBER: 2257143
LT GROUP NO: 13
LTCLASS: BRAFS DEFAULT LOGICAL TERMINAL: N
EKTS: N CACH: N
BEARER SERVICE RESTRICTIONS: NOPMD
CS: Y PS: N
VERSION: FUNCTIONAL ISSUE: 2
SPID-SUFFIX: 01
LEN: HOST 01 0 07 01 TEI: DYNAMIC
CUSTGRP: MDCSCA SUBGRP: O NCOS: O RING: Y
LINE CLASS CODE: ISDNKSET
MAXKEYS: 64
DN IS ASSIGNED AS A DNH HUNT MEMBER (NOT PILOT).
HUNT GROUP: 22 HUNT MEMBER: 4
OPTIONS:
SFC

KEY	DN	
---	--	
1	DN	2257143

KEY FEATURE
--- -----
NONE

PILOT DN: 2257141
GROUP OPTIONS:
CIR RCVD

QDN 2257144;QLT PSATS 144

DN: 2257144
TYPE: MEMBER OF DNH HUNT GROUP
SNPA: 201 SIG: N/A LNATTIDX: N/A
HUNT GROUP: 22 HUNT MEMBER: 3
LTID: PSATS 144
LTCLASS: BRAFS
LINE CLASS CODE: ISDNKSET
KEY: 1
CUSTGRP: MDCSCA SUBGRP: O NCOS: O RING: Y
OPTIONS:
SFC
PILOT DN: 2257141
GROUP OPTIONS:
CIR RCVD

H NI-1 BRI Provisioning
Northern Telecom DMS-100 Switch Translations

H-27

LTID: PSATS 144
SNPA: 201
DIRECTORY NUMBER: 2257144
LT GROUP NO: 13
LTCLASS: BRAFS DEFAULT LOGICAL TERMINAL: N
EKTS: N CACH: N
BEARER SERVICE RESTRICTIONS: NOPMD
CS: Y PS: N
VERSION: FUNCTIONAL ISSUE: 2
SPID-SUFFIX: 01
LEN: HOST 01 1 10 01 TEI: DYNAMIC
CUSTGRP: MDCSCA SUBGRP: O NCOS: O RING: Y
LINE CLASS CODE: ISDNKSET
MAXKEYS: 64
DN IS ASSIGNED AS A DNH HUNT MEMBER (NOT PILOT).
HUNT GROUP: 22 HUNT MEMBER: 3
OPTIONS:
SFC

KEY	DN	
---	--	
1	DN	2257144

KEY FEATURE
--- -----
NONE

PILOT DN: 2257141
GROUP OPTIONS:
CIR RCVD

QDN 2257145;QLT PSATS 145

DN: 2257145
TYPE: MEMBER OF DNH HUNT GROUP
SNPA: 201 SIG: N/A LNATTIDX: N/A
HUNT GROUP: 22 HUNT HENBER: 2
LTID: PSATS 145
LTCLASS: BRAFS
LINE CLASS CODE: ISDNKSET
KEY: 1
CUSTGRP: MDCSCA SUBGRP: O NCOS: O RING: Y
OPTIONS:
SFC
PILOT DN: 2257141
GROUP OPTIONS:
CIR RCVD

LTID: PSATS 145
SNPA: 201
DIRECTORY NUMBER: 2257145
LT GROUP NO: 13
LTCLASS: BRAFS DEFAULT LOGICAL TERMINAL: N
EKTS: N CACH: N
BEARER SERVICE RESTRICTIONS: NOPMD
CS: Y PS: N
VERSION: FUNCTIONAL ISSUE: 2
SPID-SUFFIX: 01
LEN: HOST 01 1 10 02 TEI: DYNAMIC
CUSTGRP: MDCSCA SUBGRP: O NCOS: O RING: Y
LINE CLASS CODE: ISDNKSET
MAXKEYS: 64
DN IS ASSIGNED AS A DNH HUNT MEMBER (NOT PILOT).
HUNT GROUP: 22 HUNT MEMBER: 2
OPTIONS:
SFC

KEY	DN	
---	--	
1	DN	2257145

KEY	FEATURE
---	-----
	NONE

PILOT DN: 2257141
GROUP OPTIONS:
CIR RCVD

QDN 2257146;QLT PSATS 146

DN: 2257146
TYPE: MEMBER OF DNH HUNT GROUP
SNPA: 201 SIG: N/A LNATTIDX: N/A
HUNT GROUP: 22 HUNT MEMBER: 1
LTID: PSATS 146
LTCLASS: BRAFS
LINE CLASS CODE: ISDNKSET
KEY: 1
CUSTGRP: MDCSCA SUBGRP: O NCOS: O RING: Y
OPTIONS:
SFC
PILOT DN: 2257141
GROUP OPTIONS:
CIR RCVD

LTID: PSATS 146
SNPA: 201
DIRECTORY NUMBER: 2257146
LT GROUP NO: 13
LTCLASS: BRAFS DEFAULT LOGICAL TERMINAL: N
EKTS: N CACH: N
BEARER SERVICE RESTRICTIONS: NOPMD
CS: Y PS: N
VERSION: FUNCTIONAL ISSUE: 2
SPID-SUFFIX: 01
LEN: HOST 01 0 07 01 TEI: DYNAMIC
CUSTGRP: MDCSCA SUBGRP: O NCOS: O RING: Y
LINE CLASS CODE: ISDNKSET
MAXKEYS: 64
DN IS ASSIGNED AS A DNH HUNT MEMBER (NOT PILOT).
HUNT GROUP: 22 HUNT MEMBER: 1
OPTIONS:
SFC

KEY	DN	
---	--	
1	DN	2257146

KEY FEATURE
--- -----
NONE

PILOT DN: 2257141
GROUP OPTIONS:
CIR RCVD

QLEN 1 1 10 1;QLEN 1 1 10 2;QLEN 1 0 7 1

LEN: HOST 01 1 10 01
ISG: 0 DCH: 1 ISG BRA Channel: 21
CARCODE: BX27AA PADGRP: NPDGP
PM NODE NUMBER: 32
PM TERMINAL NUMBER: 322

TEI	LTID	CSPSBCH/ISG Bd	
---	-----	--	--- -----
DYNAMIC	PSATS	141	Y N -
DYNAMIC	PSATS	144	Y N -

H NI-1 BRI Provisioning

Siemens SSC EWSD Switch Translations

H-30

```
LEN:      HOST  01 1 10 02
ISG: 0 DCH: 1 ISG BRA Channel: 21
CARCODE:  BX27AA      PADGRP: NPDGP
PM NODE NUMBER:  32
PM TERMINAL NUMBER:      323
```

TEI	LTID	CSPSBCH/ISG	Bd		
DYNAMIC	PSATS	142	Y	N	-
DYNAMIC	PSATS	145	Y	N	-

```
LEN:      HOST  01 0 07 01
ISG: 0 DCH: 1 ISG BRA Channel: 24
CARCODE:  BX27AA      PADGRP: NPDGP
PM NODE NUMBER:  31
PM TERMINAL NUMBER:      226
```

TEI	LTID	CSPSBCH/ISG	Bd		
DYNAMIC	PSATS	143	Y	N	-
DYNAMIC	PSATS	146	Y	N	-

STOP2

Siemens SSC EWSD Switch Translations

For the Siemens SSC EWSD switch, Capability Package "S" includes alternate voice/circuit-switched data on two B-channels. It also supports Calling Number Identification on data and voice connections. Please note that the assignment of two Directory Numbers (DNs) is required for this package.

The Siemens SSC EWSD switch allows either voice or data hunting on one DN using the Series Completion feature. The same provisioning is used for either a voice or data series completion group.

ISDN Capability Package "S"

The information listed below provides the DN translations that define Capability Package "S," and the screens and fields that must be populated.

The information provided shows the translations for one DSL and two DN. For multiple DSLs/DNs, the central office will duplicate these screens and enter the applicable DSL and DN values as needed.

ISDN Ordering Code: Capability S

DISPACCESS:EQN=20-0-5-4;
 ACCESS DATA

EXEC'D
 MASKNO:04328
 MASKNO:00000

EQN =20-0-5-4,

H NI-1 BRI Provisioning

Siemens SSC EWSD Switch Translations

H-31

```
CLOSS = 0,  
BCHEQN =2,  
BCEQN = SP & AU3 & C56 & C64,  
CPDDN = 2156855917-VI & 2156855917-CMD,  
CPVDN2 = 2156855917,  
COE = CLASS1,  
LINKOPT = DYNNOPAL,  
BAPROF = 0;
```

H NI-1 BRI Provisioning

Siemens SSC EWSD Switch Translations

H-32

DISPSUB:DN=6855917;
NPA = 215 DN = 6855917 EQN = 20-0-5-4MASKNO:03800
CAT = IBA MASKNO:03774
BCHDN = 2 MASKNO:03798
BCDN = SP &AU3 &C56 &C64 MASKNO:04535
CT = VI MASKNO:04396
LCC = BVCE RAX = 1 MASKNO:03785
BCHCT = 2 MASKNO:06282
IBCHCT = 2 MASKNO:06288
OBCHCT = 2 MASKNO:06291
PIC = 0288-SP MASKNO:04398
& 0288-AU3
CHRG = FRSA1 MASKNO:03775
COS = ICND & RND MASKNO:03777
CRBLIM = 2 MASKNO:03798
CT = CMD MASKNO:04396
LCC = BCMD RAX = 1 MASKNO:03785
BCHCT = 2 MASKNO:06282
IBCHCT = 2 MASKNO:06288
OBCHCT = 2 MASKNO:06291
PIC = 0288-C56 MASKNO:04398
& 0288-C64
CHRG = FRSA1 MASKNO:03775
COS = ICND &RND MASKNO:03777
CRBLM = 2 MASKNO:03798

DISPTSP:TSPID=215685591701 MASKNO:04383
EQN: 20-0-5-4
USID: 5
TSPID: 215685591701
TERMLIM: 1 MASKNO:04386
DN: 6855917 MASKNO:04382
CT: VI MASKNO:04385
DN: 6855917 MASKNO:04382
CT: CMD MASKNO:04385

```

DISPSUB:DN=6855919;
NPA = 215   DN = 6855919   EQN = 20-0-5-4MASKNO:03800
    CAT = IBA                               MASKNO:03774
    BCHDN = 2                               MASKNO:03798
    BCDN = SP   &AU3   &C56   &C64   MASKNO:04535
CT = VI                                       MASKNO:04396
    LCC =BVCE   RAX = 1                     MASKNO:03785
    BCHCT = 2                               MASKNO:06282
    IBCHCT = 2                              MASKNO:06288
    OBCHCT = 2                              MASKNO:06291
    PIC = 0288-SP                           MASKNO:04398
        & 0288-AU3
    CHRG = FRSA1                             MASKNO:03775
    COS = ICND & RND                         MASKNO:03777
    CRBLIM = 2                               MASKNO:03798
CT = CMD                                     MASKNO:04396
    LCC = BCMD   RAX = 1                     MASKNO:03785
    BCHCT = 2                               MASKNO:06282
    IBCHCT = 2                              MASKNO:06288
    OBCHCT = 2                              MASKNO:06291
    PIC = 0288-C56                           MASKNO:04398
        & 0288-C64
    CHRG = FRSA1                             MASKNO:03775
    COS = ICND   &RND                       MASKNO:03777
    CRBLIM = 2                               MASKNO:03798

DISPTSP:TSPID=215685591901;                MASKNO:04383
EQN: 20-0-5-4
USID: 1
TSPID: 215685591901
TERMLIM: 1                                  MASKNO:04386
DN: 6855919                                MASKNO:04382
CT: VI                                       MASKNO:04385
DN: 6855919                                MASKNO:04382
CT: CMD                                     MASKNO:04385
    
```

Series Completion Feature Translations

The information listed below provides the translation for either voice or data hunting on three Digital Subscriber Lines (DSLs) and six Directory Numbers (DNs) forming a circular series completion group.

The screens shown in this section are examples. DNs shown on these screens should be replaced with applicable data.

```

M   NAVK1/BELLCORNJRB/APS 13.0 PS0071/000   96-01-18   16:22:05
    0959           OMT-00/LEONLY           2816/04328

DISPSDNDAT:EQN=20-0-0-1&20-0-5-0&40-0-2-4:   EXEC'D

ISDN ACCESS DATA                               MASKNO:04328
                                                MASKNO:00000

VIEW = EQN.
EQN = 20-0-00-01.
    
```

H NI-1 BRI Provisioning

Siemens SSC EWSD Switch Translations

H-34

BCHEQN = 2.
BCEQN = SP.
BCEQN = AU3.
BCEQN = C56.
BCEQN = C64.
CPDDN = 2156851189-VI.
CPDDN = 2156851189-CMD.
COE = CLASS1.
LINKOPT = DYNNOPAL.
NCCSL = D1--4.
NCCSL = D2--4.
NPCSL = P1--0.
NPCSL = P2--0.
NSL = 10.
L2TIM = T200-10.
L2TIM = T201-10.
L2TIM = T203-3.
L2COUNT = N200-3.
L2COUNT = OIFDCC-1.
L2COUNT = OIFDPC-3.
CPVDN2 = 2156851189.
CPVDN2 = 2156851289:

INTERRUPTION TEXT JOB 0959

H NI-1 BRI Provisioning

Siemens SSC EWSD Switch Translations

H-35

CONTINUATION TEXT 0001

M NAVK1/BELLCORNJRB/APS 13.0 PS0071/000 96-01-18 16:22:08
0959 OMT-00/LEONLY2816/04328

SUBSCRIBER

MASKNO:04328
MASKNO:00000

VIEW = DN.
NPA = 215.
DN = 6851189.
EQN = 20-0-00-01.
BCHDN = 2.
BCDN = SP.
BCDN = AU3.
BCDN = C56.
BCDN = C64.
BCHCT = 2-VI.
BCHCT = 2-CMD.
BCHCT = 0-PMD.
IBCHCT = 2-VI.
IBCHCT = 2-CMD.
IBCHCT = 0-PMD.
OBCHCT = 2-VI.
OBCHCT = 2-CMD.
OBCHCT = 0-PMD.
CT = VI.
C1 = CMD:

INTERRUPTION TEXT JOB 0959

CONTINUATION TEXT 0002

M NAVK1/BELLCORNJRB/APS 13.0 PS0071/000 96-01-18 16:22:31
0959 OMT-00/LEONLY2816/04328

SUBSCRIBER

MASKNO:04328
MASKNO:00000

VIEW = DNCT.
NPA = 215.
DN = 6851189.
EQN = 20-0-00-01.
CT = VI.
CAT = IBA.
LCC = PKGSV.
RAX = 1.
COS = ICND.
COS = RND.
COSDAT = SERCOMP-6851289.
PIC = 222-SP.
PIC = 288-AU3.
CRBLIM = 1:

INTERRUPTION TEXT JOB 0959

H NI-1 BRI Provisioning

Siemens SSC EWSD Switch Translations

H-36

CONTINUATION TEXT 0003

M NAVK1/BELLCORNJRB/APS 13.0 PS0071/000 96-01-18 16:22:15
0959 OMT-00/LEONLY2816/04328

SUBSCRIBER

MASKNO:04328
MASKNO:00000

VIEW = DNCT.

NPA = 215.

DN = 6851189.

EQN = 20-0-00-01.

CT = CMD.

CAT = IBA.

LCC = PKGSD.

RAX = 1.

COS = ICND.

COS = RND.

COSDAT = SERCOMP-6851289.

PIC = 222-C56.

PIC = 288-C64.

CRBLIM = 1:

INTERRUPTION TEXT JOB 0959

CONTINUATION TEXT 0004

M NAVK1/BELLCORNJRB/APS 13.0 PS0071/000 96-01-18 16:22:19
0959 OMT-00/LEONLY2816/04328

SUBSCRIBER

MASKNO:04328
MASKNO:00000

VIEW = DN.

NPA = 215.

DN = 6851289.

EQN = 20-0-00-01.

BCHDN = 2.

BCDN = SP.

BCDN = AU3.

BCDN = C56.

BCDN = C64.

BCHCT = 2-VI.

BCHCT = 2-CMD.

BCHCT = 0-PMD.

IBCHCT = 2-VI.

IBCHCT = 2-CMD.

IBCHCT = 0-PMD.

OBCHCT = 2-VI.

OBCHCT = 2-CMD.

OBCHCT = 0-PMD.

CT = VI.

CT = CMD:

INTERRUPTION TEXT JOB 0959

H NI-1 BRI Provisioning

Siemens SSC EWSD Switch Translations

H-37

CONTINUATION TEXT 0005

M NAVK1/BELLCORNJRB/APS 13.0 PS0071/000 96-01-18 16:22:22
0959 OMT-00/LEONLY2816/04328

SUBSCRIBER

MASKNO:04328
MASKNO:00000

VIEW = DNCT.

NPA = 215.

DN = 6851289.

EQN = 20-0-00-01.

CT = VI.

CAT = IBA.

LCC = PKGSV.

RAX = 1.

COS = ICND.

COS = RND.

COSDAT = SERCOMP-6852199.

PIC = 222-SP.

PIC = 288-AU3.

CRBLIM = 1:

INTERRUPTION TEXT JOB 0959

CONTINUATION TEXT 0006

M NAVK1/BELLCORNJRB/APS 13.0 PS0071/000 96-01-18 16:22:26
0959 OMT-00/LEONLY2816/04328

SUBSCRIBER

MASKNO:04328
MASKNO:00000

VIEW = DNCT.

NPA = 215.

DN = 6851289.

EQN = 20-0-00-01.

CT = CMD.

CAT = IBA.

LCC = PKGSD.

RAX = 1.

COS = ICND.

COS = RND.

COSDAT = SERCOMP-6852199.

PIC = 222-C56.

PIC = 288-C64.

CRBLIM = 1:

INTERRUPTION TEXT JOB 0959

H NI-1 BRI Provisioning

Siemens SSC EWSD Switch Translations

H-38

CONTINUATION TEXT 0007

M NAVK1/BELLCORNJRB/APS 13.0 PS0071/000 96-01-18 16:22:29
0959 OMT-00/LEONLY2816/04328

TERMINAL SERVICE PROFILE DATAMASKNO:04328

MASKNO:00000

VIEW = TSP.

EQN = 20-0-00-01.

USID = 1.

TSPID = 2156851189.

TERMLIM = 1.

TSPCOS = CHDBCHR:

INTERRUPTION TEXT JOB 0959

CONTINUATION TEXT 0008

M NAVK1/BELLCORNJRB/APS 13.0 PS0071/000 96-01-18 16:22:32
0959 OMT-00/LEONLY2816/04328

TERMINAL SERVICE PROFILE DATA

MASKNO:04328

MASKNO:00000

VIEW = TSPDNCT.

EQN = 20-0-00-01.

TSPID = 2156851189.

NPA = 215.

DN = 6851189.

CT= VI:

INTERRUPTION TEXT JOB 0959

CONTINUATION TEXT 0009

M NAVK1/BELLCORNJRB/APS 13.0 PS0071/000 96-01-18 16:22:35
0959 OMT-00/LEONLY2816/04328

TERMINAL SERVICE PROFILE DATA

MASKNO:04328

MASKNO:00000

VIEW = TSPDNCT.

EQN = 20-0-00-01.

TSPID = 2156851189.

NPA = 215.

DN = 6851189.

CT= CMD:

INTERRUPTION TEXT JOB 0959

H NI-1 BRI Provisioning

Siemens SSC EWSD Switch Translations

H-39

CONTINUATION TEXT 0010

M NAVK1/BELLCORNJRB/APS 13.0 PS0071/000 96-01-18 16:22:38
0959 OMT-00/LEONLY2816/04328

TERMINAL SERVICE PROFILE DATA

MASKNO:04328
MASKNO:00000

VIEW = TSP.

EQN = 20-0-00-01.

USID = 2.

TSPID = 2156851289.

TERMLIM = 1.

TSPCOS = CHDBCHR:

INTERRUPTION TEXT JOB 0959

CONTINUATION TEXT 0011

M NAVK1/BELLCORNJRB/APS 13.0 PS0071/000 96-01-18 16:22:40
0959 OMT-00/LEONLY2816/04328

ISDN ACCESS DATA

MASKNO:04328
MASKNO:00000

VIEW = EQN.

EQN = 20-0-05-01.

BCHEQN = 2.

BCEQN = SP.

BCEQN = AU3.

BCEQN = C56.

BCEQN = C64.

CPDDN = 2156852199-VI.

CPDDN = 2156852199-CMD.

COE = CLASS1.

LINKOPT = DYNNOPAL.

NCCSL = D1--4.

NCCSL = D2--4.

NPCSL = P1--0.

NPCSL = P2--0.

NSL = 10.

L2TIM = T200-10.

L2TIM = T201-10.

L2TIM = T203-3.

L2COUNT = N200-3.

L2COUNT = OIFDCC-1.

L2COUNT = OIFDPC-3.

CPVDN2 = 2156852199.

CPVDN2 = 2156852299:

INTERRUPTION TEXT JOB 0959

H NI-1 BRI Provisioning

Siemens SSC EWSD Switch Translations

H-40

CONTINUATION TEXT 0012

M NAVK1/BELLCORNJRB/APS 13.0 PS0071/000 96-01-18 16:22:44
0959 OMT-00/LEONLY2816/04328

SUBSCRIBER

MASKNO:04328
MASKNO:00000

VIEW = DN.
NPA = 215.
DN = 6852199.
EQN = 20-0-05-00.
BCHDN = 2.
BCDN = SP.
BCDN = AU3.
BCDN = C56.
BCDN = C64.
BCHCT = 2-VI.
BCHCT = 2-CMD.
BCHCT = 0-PMD.
IBCHCT = 2-VI.
IBCHCT = 2-CMD.
IBCHCT = 0-PMD.
OBCHCT = 2-VI.
OBCHCT = 2-CMD.
OBCHCT = 0-PMD.
CT = VI.
CT = CMD:

INTERRUPTION TEXT JOB 0959

CONTINUATION TEXT 0013

M NAVK1/BELLCORNJRB/APS 13.0 PS0071/000 96-01-18 16:22:48
0959 OMT-00/LEONLY2816/04328

SUBSCRIBER

MASKNO:04328
MASKNO:00000

VIEW = DNCT.
NPA = 215.
DN = 6852199.
EQN = 20-0-05-00.
CT = VI.
CAT = IBA.
LCC = PKGSV.
RAX = 1.
COS = ICND.
COS = RND.
COSDAT = SERCOMP-6852299.
PIC = 222-SP.
PIC = 288-AU3.
CRBLIM = 1:

INTERRUPTION TEXT JOB 0959

H NI-1 BRI Provisioning

Siemens SSC EWSD Switch Translations

H-41

CONTINUATION TEXT 0014

M NAVK1/BELLCORNJRB/APS 13.0 PS0071/000 96-01-18 16:22:51
0959 OMT-00/LEONLY2816/04328

SUBSCRIBER

MASKNO:04328
MASKNO:00000

VIEW = DNCT.

NPA = 215.

DN = 6852199.

EQN = 20-0-05-00.

CT = CMD.

CAT = IBA.

LCC = PKGSD.

RAX = 1.

COS = ICND.

COS = RND.

COSDAT = SERCOMP-6852299.

PIC = 222-C56.

PIC = 288-C64.

CRBLIM = 1:

INTERRUPTION TEXT JOB 0959

CONTINUATION TEXT 0015

M NAVK1/BELLCORNJRB/APS 13.0 PS0071/000 96-01-18 16:22:55
0959 OMT-00/LEONLY2816/04328

SUBSCRIBER

MASKNO:04328
MASKNO:00000

VIEW = DN.

NPA = 215.

DN = 6852299.

EQN = 20-0-05-00.

BCHDN = 2.

BCDN = SP.

BCDN = AU3.

BCDN = C56.

BCDN = C64.

BCHCT = 2-VI.

BCHCT = 2-CMD.

BCHCT = 0-PMD.

IBCHCT = 2-VI.

IBCHCT = 2-CMD.

IBCHCT = 0-PMD.

OBCHCT = 2-VI.

OBCHCT = 2-CMD.

OBCHCT = 0-PMD.

CT = VI.

CT = CMD:

INTERRUPTION TEXT JOB 0959

H NI-1 BRI Provisioning

Siemens SSC EWSD Switch Translations

H-42

CONTINUATION TEXT 0016

M NAVK1/BELLCORNJRB/APS 13.0 PS0071/000 96-01-18 16:22:58
0959 OMT-00/LEONLY2816/04328

SUBSCRIBER

MASKNO:04328
MASKNO:00000

VIEW = DNCT.

NPA = 215.

DN = 6852299.

EQN = 20-0-05-00.

CT = VI.

CAT = IBA.

LCC = PKGSV.

RAX = 1.

COS = ICND.

COS = RND.

COSDAT = SERCOMP-6853119.

PIC = 222-SP.

PIC = 288-AU3.

CRBLIM = 1:

INTERRUPTION TEXT JOB 0959

CONTINUATION TEXT 0017

M NAVK1/BELLCORNJRB/APS 13.0 PS0071/000 96-01-18 16:23:01
0959 OMT-00/LEONLY2816/04328

SUBSCRIBER

MASKNO:04328
MASKNO:00000

VIEW = DNCT.

NPA = 215.

DN = 6852299.

EQN = 20-0-05-00.

CT = CMD.

CAT = IBA.

LCC = PKGSD.

RAX = 1.

COS = ICND.

COS = RND.

COSDAT = SERCOMP-6853119.

PIC = 222-C56.

PIC = 288-C64.

CRBLIM = 1:

INTERRUPTION TEXT JOB 0959

H NI-1 BRI Provisioning

Siemens SSC EWSD Switch Translations

H-43

CONTINUATION TEXT 0018

M NAVK1/BELLCORNJRB/APS 13.0 PS0071/000 96-01-18 16:23:05
0959 OMT-00/LEONLY2816/04328

TERMINAL SERVICE PROFILE DATA

MASKNO:04328
MASKNO:00000

VIEW = TSP.

EQN = 20-0-05-00.

USID = 1.

TSPID = 2156852199.

TERMLIM = 1.

TSPCOS = CHDBCHR:

INTERRUPTION TEXT JOB 0959

CONTINUATION TEXT 0019

M NAVK1/BELLCORNJRB/APS 13.0 PS0071/000 96-01-18 16:23:07
0959 OMT-00/LEONLY2816/04328

TERMINAL SERVICE PROFILE DATA

MASKNO:04328
MASKNO:00000

VIEW = TSPDNCT.

EQN = 20-0-05-00.

TSPID = 2156852199.

NPA = 215.

DN = 6852199.

CT= VI:

INTERRUPTION TEXT JOB 0959

CONTINUATION TEXT 0020

M NAVK1/BELLCORNJRB/APS 13.0 PS0071/000 96-01-18 16:23:11
0959 OMT-00/LEONLY2816/04328

TERMINAL SERVICE PROFILE DATA

MASKNO:04328
MASKNO:00000

VIEW = TSPDNCT.

EQN = 20-0-05-00.

TSPID = 2156852199.

NPA = 215.

DN = 6852199.

CT= CMD:

INTERRUPTION TEXT JOB 0959

H NI-1 BRI Provisioning

Siemens SSC EWSD Switch Translations

H-44

CONTINUATION TEXT 0021

M NAVK1/BELLCORNJRB/APS 13.0 PS0071/000 96-01-18 16:23:13
0959 OMT-00/LEONLY2816/04328

TERMINAL SERVICE PROFILE DATA

MASKNO:04328
MASKNO:00000

VIEW = TSP.

EQN = 20-0-05-00.

USID = 2.

TSPID = 2156852299.

TERMLIM = 1.

TSPCOS = CHDBCHR:

INTERRUPTION TEXT JOB 0959

CONTINUATION TEXT 0022

M NAVK1/BELLCORNJRB/APS 13.0 PS0071/000 96-01-18 16:23:16
0959 OMT-00/LEONLY2816/04328

ISDN ACCESS DATA

MASKNO:04328
MASKNO:00000

VIEW = EQN.

EQN = 40-0-02-04.

BCHEQN = 2.

BCEQN = SP.

BCEQN = AU3.

BCEQN = C56.

BCEQN = C64.

CPDDN = 2156853119-VI.

CPDDN = 2156853119-CMD.

COE = CLASS1.

LINKOPT = DYNNOPAL.

NCCSL = D1--4.

NCCSL = D2--4.

NPCSL = P1--0.

NPCSL = P2--0.

NSL = 10.

L2TIM = T200-10.

L2TIM = T201-10.

L2TIM = T203-3.

L2COUNT = N200-3.

L2COUNT = OIFDCC-1.

L2COUNT = OIFDPC-3.

CPVDN2 = 2156853119.

CPVDN2 = 2156853219:

INTERRUPTION TEXT JOB 0959

H NI-1 BRI Provisioning

Siemens SSC EWSD Switch Translations

H-45

CONTINUATION TEXT 0023

M NAVK1/BELLCORNJRB/APS 13.0 PS0071/000 96-01-18 16:23:20
0959 OMT-00/LEONLY2816/04328

SUBSCRIBER

MASKNO:04328
MASKNO:00000

VIEW = DN.
NPA = 215.
DN = 6853119.
EQN = 40-0-02-04.
BCHDN = 2.
BCDN = SP.
BCDN = AU3.
BCDN = C56.
BCDN = C64.
BCHCT = 2-VI.
BCHCT = 2-CMD.
BCHCT = 0-PMD.
IBCHCT = 2-VI.
IBCHCT = 2-CMD.
IBCHCT = 0-PMD.
OBCHCT = 2-VI.
OBCHCT = 2-CMD.
OBCHCT = 0-PMD.
CT = VI.
CT = CMD:

INTERRUPTION TEXT JOB 0959

CONTINUATION TEXT 0024

M NAVK1/BELLCORNJRB/APS 13.0 PS0071/000 96-01-18 16:23:23
0959 OMT-00/LEONLY2816/04328

SUBSCRIBER

MASKNO:04328
MASKNO:00000

VIEW = DNCT.
NPA = 215.
DN = 6853119.
EQN = 40-0-02-04.
CT = VI.
CAT = IBA.
LCC = PKGSV.
RAX = 1.
COS = ICND.
COS = RND.
COSDAT = SERCOMP-6853219.
PIC = 222-SP.
PIC = 288-AU3.
CRBLIM = 1:

INTERRUPTION TEXT JOB 0959

H NI-1 BRI Provisioning

Siemens SSC EWSD Switch Translations

H-46

CONTINUATION TEXT 0025

M NAVK1/BELLCORNJRB/APS 13.0 PS0071/000 96-01-18 16:23:27
0959 OMT-00/LEONLY2816/04328

SUBSCRIBER

MASKNO:04328
MASKNO:00000

VIEW = DNCT.

NPA = 215.

DN = 6853119.

EQN = 40-0-02-04.

CT = CMD.

CAT = IBA.

LCC = PKGSD.

RAX = 1.

COS = ICND.

COS = RND.

COSDAT = SERCOMP-6853219.

PIC = 222-C56.

PIC = 288-C64.

CRBLIM = 1:

INTERRUPTION TEXT JOB 0959

CONTINUATION TEXT 0026

M NAVK1/BELLCORNJRB/APS 13.0 PS0071/000 96-01-18 16:23:30
0959 OMT-00/LEONLY2816/04328

SUBSCRIBER

MASKNO:04328
MASKNO:00000

VIEW = DN.

NPA = 215.

DN = 6853219.

EQN = 40-0-02-04.

BCHDN = 2.

BCDN = SP.

BCDN = AU3.

BCDN = C56.

BCDN = C64.

BCHCT = 2-VI.

BCHCT = 2-CMD.

BCHCT = 0-PMD.

IBCHCT = 2-VI.

IBCHCT = 2-CMD.

IBCHCT = 0-PMD.

OBCHCT = 2-VI.

OBCHCT = 2-CMD.

OBCHCT = 0-PMD.

CT = VI.

CT = CMD:

INTERRUPTION TEXT JOB 0959

H NI-1 BRI Provisioning

Siemens SSC EWSD Switch Translations

H-47

CONTINUATION TEXT 0027

M NAVK1/BELLCORNJRB/APS 13.0 PS0071/000 96-01-18 16:23:34
0959 OMT-00/LEONLY2816/04328

SUBSCRIBER

MASKNO:04328
MASKNO:00000

VIEW = DNCT.

NPA = 215.

DN = 6853219.

EQN = 40-0-02-04.

CT = VI.

CAT = IBA.

LCC = PKGSV.

RAX = 1.

COS = ICND.

COS = RND.

COSDAT = SERCOMP-6851189.

PIC = 222-SP.

PIC = 288-AU3.

CRBLIM = 1:

INTERRUPTION TEXT JOB 0959

CONTINUATION TEXT 0028

M NAVK1/BELLCORNJRB/APS 13.0 PS0071/000 96-01-18 16:23:37
0959 OMT-00/LEONLY2816/04328

SUBSCRIBER

MASKNO:04328
MASKNO:00000

VIEW = DNCT.

NPA = 215.

DN = 6853219.

EQN = 40-0-02-04.

CT = CMD.

CAT = IBA.

LCC = PKGSD.

RAX = 1.

COS = ICND.

COS = RND.

COSDAT = SERCOMP-6851189.

PIC = 222-C56.

PIC = 288-C64.

CRBLIM = 1:

INTERRUPTION TEXT JOB 0959

H NI-1 BRI Provisioning

Siemens SSC EWSD Switch Translations

H-48

CONTINUATION TEXT 0029

M NAVK1/BELLCORNJRB/APS 13.0 PS0071/000 96-01-18 16:23:40
0959 OMT-00/LEONLY2816/04328

TERMINAL SERVICE PROFILE DATA

MASKNO:04328
MASKNO:00000

VIEW = TSP.

EQN = 40-0-02-04.

USID = 1.

TSPID = 2156853119.

TERMLIM = 1.

TSPCOS = CHDBCHR:

INTERRUPTION TEXT JOB 0959

CONTINUATION TEXT 0030

M NAVK1/BELLCORNJRB/APS 13.0 PS0071/000 96-01-18 16:23:43
0959 OMT-00/LEONLY2816/04328

TERMINAL SERVICE PROFILE DATA

MASKNO:04328
MASKNO:00000

VIEW = TSPDNCT.

EQN = 40-0-02-04.

TSPID = 2156853119.

NPA = 215.

DN = 6853119.

CT= VI:

INTERRUPTION TEXT JOB 0959

CONTINUATION TEXT 0031

M NAVK1/BELLCORNJRB/APS 13.0 PS0071/000 96-01-18 16:23:46
0959 OMT-00/LEONLY2816/04328

TERMINAL SERVICE PROFILE DATA

MASKNO:04328
MASKNO:00000

VIEW = TSPDNCT.

EQN = 40-0-02-04.

TSPID = 2156853119.

NPA = 215.

DN = 6853119.

CT= CMD:

INTERRUPTION TEXT JOB 0959

H NI-1 BRI Provisioning

Siemens SSC EWSD Switch Translations

H-49

CONTINUATION TEXT 0032

M NAVK1/BELLCORNJRB/APS 13.0 PS0071/000
0959 OMT-00/LEONLY2816/04328

96-01-18

16:23:49

TERMINAL SERVICE PROFILE DATA

MASKNO:04328

MASKNO:00000

VIEW = TSP.

EQN = 40-0-02-04.

USID = 2.

TSPID = 2156853219.

TERMLIM = 1.

TSPCOS = CHDBCHR:

END JOB 0959 EXEC'D

H NI-1 BRI Provisioning

Siemens SSC EWSD Switch Translations

H-50

Network Engineering Forms



This appendix contains one copy of each of the network planning forms used by the Network Engineering Group to plan and configure a MERLIN LEGEND Release 6.0 (or later) private network. The forms are listed in [Table I-1](#). You should make copies of these forms and use the copies, keeping the originals for future use.



NOTE:

To contact the Network Engineering Group, call 1-888-297-4700.

The system planning forms are presented in [Appendix B](#). Planning forms for data communications are presented in [Appendix C](#). The T1/PRI Planner is presented in [Appendix D](#). The NI-1 BRI Planner is presented in [Appendix G](#).

Table I-1. Network Forms

Used for	Form No.	Form Title
Requesting assistance from the Sales and Design Support Center	E-1154	Request for Sales and Design Support Center Services
Preliminary network planning	N/A	MERLIN LEGEND Network Design Implementation Guide



REQUEST FOR SALES AND DESIGN SUPPORT CENTER SERVICES (E-1154)

Check each service being requested and describe in Scope of Work below:

- | | | | |
|--|--|--|---|
| <input type="checkbox"/> Technical Assurance
(Check products) | <input type="checkbox"/> Installation Specifications
<input type="checkbox"/> DEFINITY
<input type="checkbox"/> AUDIX / Intuity
<input type="checkbox"/> MERLIN LEGEND Networking | <input type="checkbox"/> Floorplan
<input type="checkbox"/> Sys Mgmt / CAS
<input type="checkbox"/> UPS / DC Power | <input type="checkbox"/> Other
<input type="checkbox"/> CONVERSANT
<input type="checkbox"/> CMS |
|--|--|--|---|

GENERAL INFORMATION: (Complete all fields):

DESIGN CENTER FAX: 303-850-8932

CUSTOMER INFORMATION	ACCOUNT TEAM INFORMATION
Name: _____	Name: _____ Title: _____
Address _____	Address _____
City: _____ ST: _____ Zip: _____	City: _____ ST: _____ Zip: _____
LDN: _____	Tel.No.: _____ FAX: _____
IL: _____ (if multiple ILs are involved, list others below in Scope of Work)	e-mail id: _____
Cust. Contact Name: _____	MBO Code to be Charged: _____ (if multiple MBO Codes are to be charged, list below in Scope of Work)
Cust. Contact Tel. No.: _____ <input type="checkbox"/> Mark if Customer Permission for Switch Access has been granted.	
MBO Project No.: _____	Alternate Contact: _____ Title: _____
Project Manager: _____	
Tel. No.: _____	Tel. No.: _____

PRE CONTRACT OR **POST CONTRACT.** **ATTOMS/DOSS Ref No's** _____

Please list model and version of ALL Products (Switches and Adjuncts), both existing and/or proposed. Also specify the number of nodes in an existing and/or proposed network plus hardware connectivity (digital/analog) and attach diagram.

New Add Upgrade RFP Controlled Introduction

Scope of Work: _____

Requested Due Date for Technical Assurance: _____ Written Response Verbal Response

Requested Due Date for Floorplans: _____ for Specifications, other Deliverables: _____

MOJ Date: _____ **Cutover Date:** _____

MERLIN LEGEND NETWORK DESIGN IMPLEMENTATION GUIDE (Release 6.0 and Later Systems)

Network Map:

In the space provided below, please provide a drawing of your network configuration. For ease of discussion, please identify each site by a Node Number. (Usually, if a DEFINITY is part of the network, it will be identified as Node 1). Please include type of system, facilities interconnecting the systems, facilities connecting to the PSTN, extension numbers, etc.

Customer Name: _____

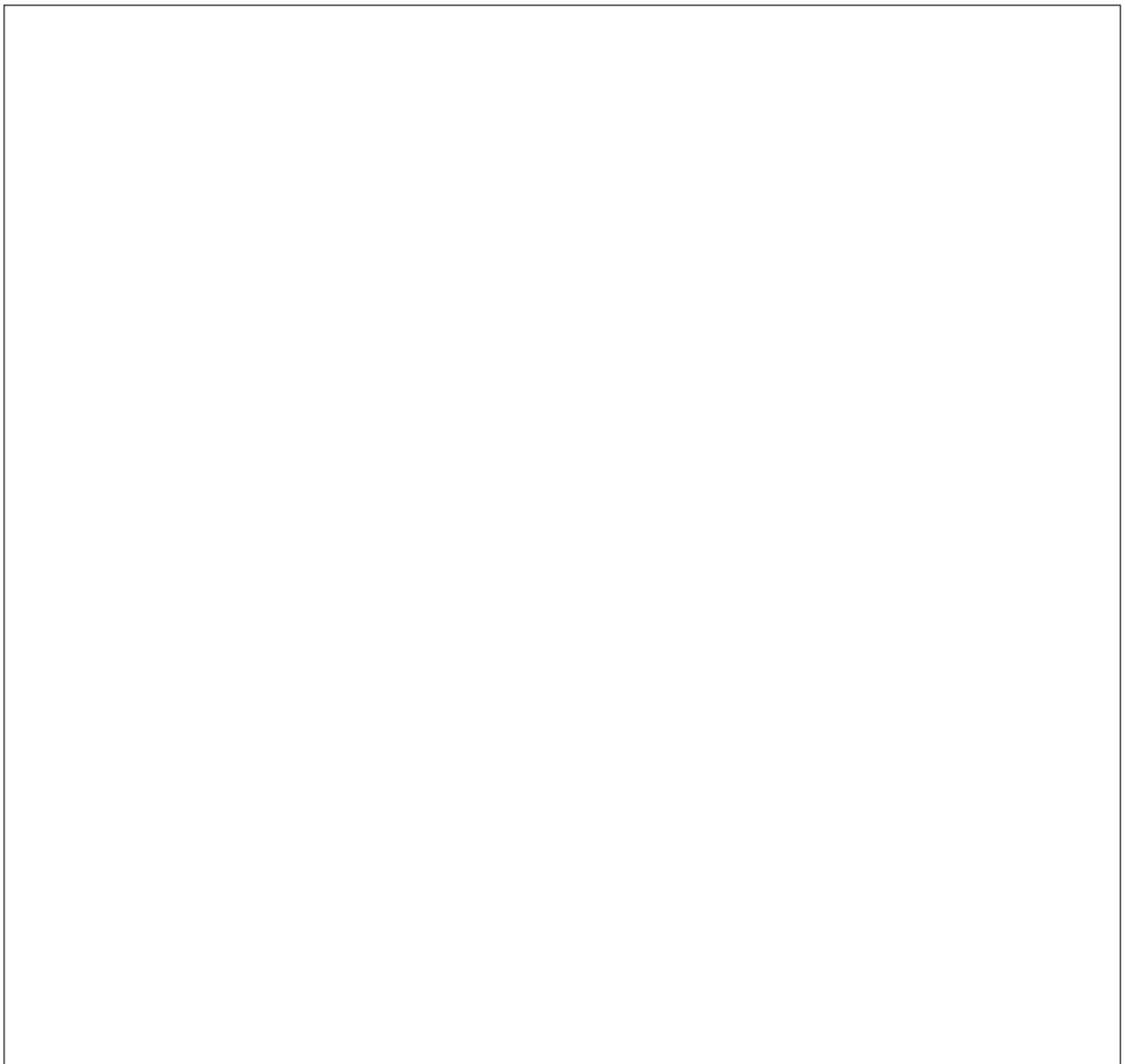

Network Configuration

MERLIN LEGEND NETWORK DESIGN IMPLEMENTATION GUIDE (CONTINUED)

*If providing information for more than one site, please complete separate Design Implementation Guide pages 2 through 6 for **each site**. (Multiple Network Configuration drawings are not required).*

Site/Customer Information:

Node Number: _____
 Name: _____
 Address: _____
 City: _____ State: _____ Zip: _____
 LDN: _____
 IL: _____
 Customer Contact Name: _____
 Customer Contact Tel. No.: _____

System Setup: (Show all pack codes and designations, e.g., LS/GS, MLX, etc.)

CABINET 1		CABINET 2		CABINET 3	
Slot	Module	Slot	Module	Slot	Module
0	Processor (R6)	6		12	
1		7		13	
2		8		14	
3		9		15	
4		10		16	
5		11		17	

If Legend exists, list the current Timing/Synchronization (DS1 or BRI Pack Location)

Current Synchronization: Primary: _____
 Secondary: _____
 Tertiary: _____

MERLIN LEGEND NETWORK DESIGN IMPLEMENTATION GUIDE (CONTINUED)

Customer Name: _____ Node: _____

Dial Plan information:

- *Dial plan numbers for extensions, adjuncts, lines, and calling groups must be unique across the network. Numbers will have to be changed if a conflict is encountered.*
- *MERLIN LEGEND routes Non-Local UDP calls by matching number ranges entered into the Non-Local UDP tables. These number ranges can consist of 2- to 4-digit numbers. Four-digit dial plans are recommended for MERLIN LEGEND. If a DEFINITY is in the network, and has a 5-digit dial plan, MERLIN LEGEND routes the call on 4-digits, but will send 5 digits.*
- *Pool numbers and line numbers will be made unique across the network. This will be transparent to the customer.*

- What extension range is desired for this location: _____
(Any additional extension ranges?) _____
(Does this range allow for growth?) _____

- What adjunct range is desired for this location: _____
(Any additional extension ranges?) _____
(Does this range allow for growth?) _____

Automatic Route Selection (ARS):

- *It is strongly recommended that each system in the network have at least 1 local CO line for emergency use (e.g., 911 calls, power failure use, etc.).*
- *Traffic must be considered when routing ARS calls across the network to assure that enough lines are available to handle call volume.*

- ARS access code ____ *The same ARS access code is recommended on all systems.*

- Will ARS be used to access the facilities on another system on the network for making local calls _____ ? long distance calls _____ ?

- Will other systems on the network use this system's ARS for making local calls _____ ? long distance calls _____ ?

- Have ARS tables been administered, or are only the default tables used?
Default only? _____ Other tables are used. _____

NOTE: *There are additional engineering charges when the Design Center engineers the custom ARS tables (1-16), i.e., TEHO. Consult with the assigned engineer.*

MERLIN LEGEND NETWORK DESIGN IMPLEMENTATION GUIDE (CONTINUED)

Customer Name: _____ **Node:** _____

- Is Remote Access used, or planned to be used, in this system? _____

- Does this customer intend to install a Centralized Voice Messaging System (Release 6.1 and later systems) on this **all Legend Network**?

Yes ___ **No**___

If yes, which VMS is to be used:

INTUITY: _____

MERLIN LEGEND Mail: _____

Messaging 2000: _____

AUDIX Voice Power: _____

NOTE: Centralized Voice Mail within a DEFINITY to MERLIN LEGEND network is not supported.

- Is customer planning to use Auto-Attendant to route calls across the network (to non-local UDP stations)?

Yes ___ **No**___

- If yes, which Voice Mail or Automated Attendant system do you plan to use?

MERLIN LEGEND NETWORK DESIGN IMPLEMENTATION GUIDE (CONTINUED)

Customer Name: _____ **Node:** _____

Public Switched Telephone Network lines:

Loop Start/Ground Start

Trk IDs	Pool	Type	COMMENTS

DID - Are DIDs connected to this system routing calls to non-local extensions? Y / N.

If yes, Local DID number range _____ .

Non-Local DID number range _____ .

Are DIDs connected to another system routing calls to this system? Y / N.

If yes, on what Node are the DIDs connected _____ .

Trk IDs	Block	Type	ExpDig	DelDig	AddDig	COMMENTS

Tie Trunks (Analog) or (Digital)

Trk IDs	Pool	Dir	InType	OutType	E&M Sig	InMode	OutMode	DialTone

NOTE: *If analog E&M Tie Lines are used to interconnect systems, calls can only go over two hops, due to call setup time and transmission issues.*

100D - DS1 (T1 - PRI)

Slot	Type	Format	Supp	Signal	LnComp	ClkSync	Src	*SwType
	T1/PRI	D4/esf	zcs/b8zs	rbs/com	1-5	p/s/t	lp/loc	

* 4E=4ESS, 5E=5ESS, 100=DMS100, 250=DMS250, DEX=DEX600E,
LN=Legend-NTWK, LP=Legend-PBX

NOTE: *When ordering point-to-point T1, parameters **must** be designated. We recommend ESF framing and B8ZS zero code suppression.*

MERLIN LEGEND NETWORK DESIGN IMPLEMENTATION GUIDE (CONTINUED)

Customer Name: _____ **Node:** _____

100D - DS1 (T1 - PRI) (continued)

PRI - T1 Assignments

Slot	Channels	Trunk IDs	Pool	Notes

Provide Circuit Numbers of T1 - PRI circuits _____

Who is the Service Provider? _____

Who is providing the CSU/MUX? _____
CSU/MUX Type? _____

NOTE: IF 3160 CSU/DSU IS USED, CHECK WITH ENGINEER ON CHANNELIZATION AND TIMING (SYNCH) PRIOR TO SUBMITTING FORMS TO DATA GROUP FOR CSU TRANSLATIONS.

Glossary



NOTE:

The use of italics in this glossary denotes a cross-reference to other glossary entries or the expanded name for an acronym.

Numerics

- 2B Data** Digital information carried by two *B-channels* for better performance and quality; the *bit rate* is twice that of one B-channel used alone.
- 7500B Data Module** See [ISDN 7500B Data Module](#).

A

- Account Code** Code used to associate incoming and outgoing calls with corresponding accounts, employees, projects, and clients.
- ACCUNET** AT&T's switched digital service for 56-kbps, 64-kbps restricted, and 64-kbps clear circuit-switched data calls.
- Address** Coded representation of the destination of data or of the data's originating terminal, such as the dialed extension number assigned to the data terminal. Multiple terminals on one communications line each must have a unique address.
- ADDS** *Automated Document Delivery System*. Computer-based application that stores documents in a database and automatically faxes them on request.
- Adjunct** Optional equipment used with the communications system, such as an alerting device or *modem* that connects to a multiline telephone or to an extension jack.
- ALS** *Automatic Line Selection*. Programmed order in which the system makes outside lines available to a user.
- Ambiguous Numbering** Numbering of extension ranges, remote access codes, or other system components that causes conflicts in network operations. These numbers can be unique and still be ambiguous. For example, Extension 441 is different from Extension 4410; for *UDP routing* purposes, however, the two numbers are ambiguous and a call intended for Extension 4410 would be misrouted, on the first three digits sent, to Extension 441. See also [Unambiguous Numbering](#).
- AMI** *Alternate Mark Inversion*. Line coding format in which a binary one is represented by a positive or negative pulse, a binary zero is represented by no line signal, and subsequent binary ones must alternate in polarity; otherwise, a *bipolar violation* occurs. AMI is used in the *DS1* interface.

Analog Data Station	See Modem Data Station .
Analog Multiline Telephone	Also known as the MERLIN multiline telephone, this telephone transmits and receives analog signals and has a number of line buttons.
Analog Transmission	Mode of transmission in which information is represented in continuously variable physical quantities, such as amplitude, frequency, phase, or resistance. See also Digital Transmission .
ANI	<i>Automatic Number Identification</i> . Process of automatically identifying a caller's billing number and transmitting that number from the caller's local central office to another point on or off the public network.
Application	Software and/or hardware that adds functional capabilities to the system. For example, MERLIN Identifier is an application that provides caller identification information (if available in the local area or jurisdiction).
ARS	<i>Automatic Route Selection</i> . System feature that routes calls on outside facilities according to the number dialed and line/trunk availability. To initiate ARS, the user dials a <i>dial-out code</i> , also called an "ARS access code."
ASCAP	<i>American Society of Composers, Artists, and Producers</i> .
Ascend Pipeline 25PX/75PX	ISDN-BRI bridge/router that enables high-speed Internet access over a digital facility. It makes outgoing calls only.
ASN	<i>AT&T Switched Network</i> . AT&T telecommunications services provided through an Integrated Digital Services Network Primary Rate Interface (ISDN-PRI) trunk, <i>ACCUNET</i> switched digital service, <i>MEGACOM</i> , <i>MEGACOM 800</i> , Software Defined Network (<i>SDN</i>), Multiquest, and Shared Access for Switch Services (<i>SASS</i>).
Asynchronous Data Transmission	Method of transmitting a short bitstream of digital data, such as printable characters represented by a 7- or 8-bit ASCII code. Each string of data bits is preceded by a start bit and followed by a stop bit, thus permitting data to be transmitted at irregular intervals. See also Synchronous Data Transmission .
AT&T Attendant	Application with equipment that connects to one or more <i>tip/ring</i> extension jacks and automatically answers incoming calls with a recorded announcement; directs calls in response to touch tones.
AT&T Switched Network	See ASN .
AUDIX Voice Power	Voice-processing application, part of <i>IS II/III</i> , that provides Automated Attendant, Call Answer, Information Service, Message Drop, Voice Mail, and, optionally, <i>Fax Attendant System</i> for use with the system.

Automated Attendant	<i>IS II/III, MERLIN LEGEND Mail, and Lucent Technologies Attendant</i> application that automatically answers incoming calls with a recorded announcement and directs callers to a department, an extension, or the system operator.
Automated Document Delivery System	See ADDS .
Automatic Immediate Cycling	Process that occurs in a <i>private network</i> when all available routes for a call specify systems with matching <i>switch identifiers</i> . The call is routed from the originating system to the destination system and back to the originating system in a continuous loop. <i>Switch identifier</i> labeling systems must be unique across a network.
Automatic Line Selection	See ALS .
Automatic Number Identification	See ANI .
Automatic Ringdown Tie-Trunk	See Automatic-Start Tie Trunk .
Automatic Route Selection	See ARS .
Automatic-Start Tie Trunk	<i>Tie trunk</i> on which incoming calls are routed to an operator or other designated destination without a start signal, as soon as the trunk is seized; the destination is specified during programming. Also called "Automatic Ringdown" or "Auto-In" Tie Trunk.
Auxiliary Power Unit	Device that provides additional power to the system.

B

B8ZS	<i>Bipolar 8 Zero Substitution</i> . Line-coding format that encodes a string of eight zeros in a unique binary sequence to detect bipolar violations.
Backup	Procedure for saving a copy of system programming onto a floppy disk or <i>memory card</i> . See also Restore .
Bandwidth	Difference, expressed in hertz, between the highest and lowest frequencies in a range that determines channel capacity.
Barrier Code	Password used to limit access to the <i>Remote Access</i> feature of the system. In a <i>private network</i> , it is especially important that barrier codes be required for all types of remote access.
Basic Carrier	Hardware that holds and connects the <i>processor module, power supply module</i> , and up to five other modules in the system. See also Expansion Carrier .

Baud Rate	Strictly speaking, a measurement of transmission speed equal to the number of signal level changes per second. In practice, often used synonymously with <i>bit rate</i> and <i>bps</i> .
B-Channel	<i>Bearer-Channel</i> . 64- or 56-kbps channel that carries a variety of digital information streams, such as voice at 64 kbps, data at up to 64 kbps, wideband voice encoded at 64 kbps, and voice at less than 64 kbps, alone or combined.
Basic Rate Interface	See BRI .
Bearer-Channel	See B-Channel .
Behind Switch Mode	One of three modes of system operation in which the control unit is connected to (behind) another telephone switching system, such as <i>Centrex</i> or <i>DEFINITY</i> , which provides features and services to telephone users. See also Hybrid/PBX Mode and Key Mode .
Binary Code	Electrical representation of quantities or symbols expressed in the base-2 number system, which includes zeros and ones.
Bipolar 8 Zero Substitution	See B8ZS .
Bipolar Signal	Digital signal in which pulses (ones) alternate between positive and negative. See also AMI , B8ZS , and Bipolar Violation .
Bipolar Violation	Condition occurring when two positive or two negative pulses are received in succession. See also AMI and B8ZS .
BIS	<i>Built-In Speakerphone</i> . Part of the model name of some analog multiline telephones.
Bit	<i>Binary Digit</i> . One unit of information in binary notation; it can have one of two values—zero or one.
Bit Rate	Speed at which bits are transmitted, usually expressed in <i>bps</i> . Also called “data rate.”
Blocking	Condition in which end-to-end connections cannot be made on calls because of a full load on all possible services and facilities. See also Glare .
BMI	<i>Broadcast Music Incorporated</i> .
Board	Module—for example, 100D or 408 MLX GS/LS—that allows you to connect lines/trunks and extensions to the communications system.
Board Assignment	System Programming and Maintenance (SPM) procedure for assigning line/trunk and extension modules to slots on the control unit.
Board Renumbering	System programming procedure for renumbering boards that have already been assigned to specific slots on the control unit.

bps	<i>Bits per second.</i>
BRI	<i>Basic Rate Interface.</i> Standard protocol for accessing Integrated Service Digital Network (ISDN) services.
Broadband	Transmission path having a bandwidth greater than a voice-grade channel.
BTMI	<i>Basic Telephone Modem Interface.</i>
Bus	Multiconductor electrical path used to transfer information over a common connection from any of several sources to any of several destinations.
Button	Key on the face of a telephone that is used to access a line, activate a feature, or enter a code on a communications system.
Byte	Sequence of <i>bits</i> (usually eight) processed together. Also called "octet."

C

Call Accounting System	See CAS .
Call Accounting Terminal	See CAT .
Caller ID	Service provided by some local telephone companies (if local regulations allow) that supplies the calling party telephone number. In Release 3.0 and later, an 800 GS/LS-ID module on the system can capture this information and display it on the screens of MLX telephones. In Release 7.0 and later, an 800 GS/LS-ID, 408 GS/LS-ID-MLX, or 412 LS-ID-ETR module can capture both the number and name of the calling party and display them on the screens of MLX, ETR, and MLS telephones. See also ANI .
Calling Group	Team of individuals who answer the same types of calls.
Call Management System	See CMS .
Calling Party Name on Caller ID	This central office service allows a subscriber to view the name of the calling party on an MLX, ETR, or MLS display telephone.
Calling Party Number on Caller ID	This central office service allows a subscriber to view the number of the calling party on an MLX, ETR, or MLS display telephone.
CAS	<i>Call Accounting System.</i> DOS- or UNIX System-based application that monitors and manages telecommunications costs.
CAT	<i>Call Accounting Terminal.</i> Stand-alone unit with a built-in microprocessor and data buffer that provides simple call accounting at a low cost.

CCITT	<i>International Telegraph and Telephone Consultative Committee.</i>
CCS	<i>Common-Channel Signaling.</i> Signaling in which one channel of a group of channels carries signaling information for each of the remaining channels, permitting each of the remaining channels to be used to nearly full capacity. In the system's 100D module, channel 24 can be designated as the signaling channel for channels 1–23.
Centralized Telephone Programming	Programming of features on individual telephones; performed at a central location by the system manager. See also System Programming and Extension Programming .
Centralized Voice Messaging	Sharing of a voice messaging system by two or more directly connected MERLIN LEGEND Systems in a <i>private network</i> . Available beginning in Release 6.1.
Central Office	See CO .
Centrex	Set of system features to which a user can subscribe on telephone trunks from the local telephone company.
Channel	Telecommunications transmission path for voice and/or data.
Channel Service Unit	See CSU .
Checksum	Sum of ones in a sequence of ones and zeros, used to detect or correct errors in data transmission.
Circuit-Switched Data Call	Data call made through an exclusively established and maintained connection between <i>data stations</i> .
Class of Restriction	See COR .
Clear Data Channel	Clear data channels (also called unrestricted data channels) allow the transmission of occurrences of more than seven contiguous zero bits. If a clear data channel is requested and only restricted channels are available, the call will be rejected. See also Restricted Data Channel .

Clock Synchronization	When digital signals are transmitted over a communications link, the receiving end must be synchronized with the transmitting end to receive the digital signals without errors using clock synchronization. A system synchronizes itself by extracting a timing signal from an incoming digital stream. All the digital facilities in a network operate from a single common clock—preferably a port connected to a digital <i>PSTN</i> facility on a <i>hub system</i> or a system that connects two network systems. In this case, all digital facilities specify a loop clock source. One system in a network may be specified as a local clock source when no functioning digital facility in the network is connected to the <i>PSTN</i> . All other digital facilities then use this clock and specify their clock sources as loop. Primary, secondary, and tertiary clock sources are specified to allow backup synchronization in the event that the primary source is out of service.
CMS	<i>Call Management System</i> . DOS-based application that simulates the actions of a system operator by answering and distributing calls. Also produces reports for call analysis.
CO	<i>Central Office</i> . Location of telephone switching equipment that provides local telephone service and access to toll facilities for long-distance calling.
Coaxial Cable	Cable consisting of one conductor, usually a small copper tube or wire within, and insulated from, another conductor of larger diameter—usually copper tubing or copper braid.
Codec	<i>Coder-Decoder</i> . Device used to convert analog signals—such as speech, music, or television—to digital form for transmission over a digital medium and back to the original analog form.
Collected Digits	Digits that a caller dials in response to an integrated voice response application's menus (also called <i>prompted digits</i>); collected digits may be used to initiate a <i>screen pop</i> at a system extension. See also CTI Link .
Combination Configuration	<i>Private network</i> arrangement that combines characteristics of <i>Virtual Private Network (VPN)</i> , a <i>series configuration</i> , and a <i>star configuration</i> .
Common Channel Signaling	See CCS .
Communications System	Software-controlled processor complex that interprets dialing pulses, tones, and/or keyboard characters and makes the proper interconnections—both inside and outside. Consists of a computer, software, a storage device, and carriers with special hardware to perform the actual connections. Provides voice and/or data communications services, including access to public and private networks, for telephones and other equipment. Also referred to in this guide as “system,” short for MERLIN LEGEND Communications System.

Control Unit	<i>Processor module, power supply module, other modules, carriers, and housing of the system.</i>
Console	Telephone and <i>adjuncts</i> (if any) at an operator or system programmer extension.
CONVERSANT	Entry-level voice response application that automatically answers and routes calls and executes telephone transactions.
Conversion Resource	See Modem Pool .
Coordinating System Manager	In a <i>private network</i> that includes more than two systems, the system manager who acts as a clearinghouse for any changes made on local systems that affect the network, assuring that all system managers work together and that local system changes do not have undesirable effects on the network as a whole.
COR	<i>Class of Restriction</i> . Various types of restrictions that can be assigned to <i>remote access</i> trunks or barrier codes. These restrictions consist of calling restrictions, ARS Facility Restriction Levels (<i>FRLs</i>), Allowed Lists, Disallowed Lists, and Automatic Callback queuing.
Coverage	Set of system features that can determine how an extension's calls are covered when the person at the extension is busy or not available.
CRC	<i>Cyclic Redundancy Check</i> . Error-detection code used on <i>DS1</i> facilities with the extended superframe format (<i>ESF</i>).
CSU	<i>Channel Service Unit</i> . Equipment used on customer premises to provide <i>DS1</i> facility terminations and signaling compatibility.
CTI Link	<i>Computer Telephony Integration</i> . Hardware/software feature that is part of the PassageWay Telephony Services application. It allows the use of Lucent Technologies-certified software applications on a <i>LAN</i> running Novell NetWare software in a <i>Hybrid/PBX mode</i> system. These applications may provide special features for client control of such calling activities as power dialing. See also Screen Pop .
Cyclic Redundancy Check	See CRC .

D

D4 Framing Format	<i>Framing format</i> consisting of a sequence of individual frames of 24 eight-bit slots and one signal bit (193 bits) in a 12-frame superframe. See also ESF .
Data-Channel	See D-Channel .

Data Communications Equipment	See DCE .
Data Module	Type of <i>ISDN terminal adapter</i> that acts as the <i>DCE</i> at a <i>data workstation</i> that communicates over high-speed <i>digital</i> facilities.
Data Rate	See bps .
Data Station	Special type of extension where data communications take place; includes <i>DTE</i> and <i>DCE</i> ; sometimes a telephone is also part of a data station.
Data Terminal	Input/output device (often a personal computer) that can be connected to the control unit via an interface.
Data Terminal Equipment	See DTE and Data Terminal .
Data Workstation	Special type of extension where data communications take place; includes <i>DTE</i> and <i>DCE</i> ; sometimes a telephone is also part of a data workstation.
DCE	<i>Data Communications Equipment</i> . Equipment, such as <i>modems</i> or <i>ISDN terminal adapters</i> , used to establish, maintain, and terminate a connection between the system and data terminal equipment (<i>DTE</i>)—such as printers, personal computers, host computers, or network workstations.
DCP	<i>Digital Communications Protocol</i> . AT&T proprietary protocol to transmit digitized voice and data over the same communications link.
D-Channel	<i>Data-Channel</i> . 16- or 64-kbps channel that carries signaling information or data on a <i>PRI</i> or <i>BRI</i> .
Dedicated Feature Buttons	The imprinted feature buttons on a telephone: Conf or Conference, Drop, Feature, HFAI (Hands-Free Answer on Intercom), Hold, Message, Mute or Microphone, Recall, Speakerphone or Spkrphone, and Transfer.
Delay-Start Tie Trunk	<i>Tie trunk</i> or <i>tandem tie trunk</i> on which the originating end of the tie trunk transmits an off-hook signal to the receiving end and waits for the receiving end to send an off-hook signal followed by an on-hook signal. Also called “dial-repeating tie trunk.”
Desktop Videoconferencing System	System application that allows face-to-face, simultaneous video and voice communications between individuals and requires high-speed data transmission facilities. See also Group Videoconferencing System .
DFT	<i>Direct Facility Termination</i> . See Personal Line .
DHG	<i>Data Hunt Group</i> . Group of analog or digital <i>data stations</i> that share a common access code. Calls are connected in a round-robin fashion to the first available data station in the group.
Dial Access	See Feature Code .

Dialed Number Identification Service	See DNIS .
Dial-Out Code	Digit (usually a 9) or digits dialed by telephone users to get an outside line.
Dial Plan	Numbering scheme for system extensions, lines, and trunks.
Dial-Repeating Tie Trunk	<i>Tie trunk</i> on which the originating end of the tie trunk transmits an off-hook signal to the receiving end and waits for the receiving end to send an off-hook signal followed by an on-hook signal. Also called "dial-repeating tie trunk."
DID	<i>Direct Inward Dial</i> . Service that transmits from the telephone company central office and routes incoming calls directly to the called extension, <i>calling group</i> , or outgoing line/trunk <i>pool</i> , bypassing the system operator.
DID Trunk	Incoming trunk that receives dialed digits from the local exchange, allowing the system to connect directly to an extension without assistance from the system operator.
Digital	Representation of information in discrete elements—such as off and on or zero and one. See also Analog Transmission .
Digital Communications Protocol	See DCP .
Digital Data Station	See ISDN Terminal Adapter Data Station .
Digital Signal 0	See DS0 .
Digital Signal 1	See DS1 .
Digital Subscriber Line	See DSL .
Digital Transmission	Mode of transmission in which the information to be transmitted is first converted to digital form and then transmitted as a serial stream of pulses. See also Analog Transmission .
DIP Switch	<i>Dual In-line Package</i> . Switch on a 400EM module used to select the signaling format for tie-line transmission. Also used on other equipment for setting hardware options.
Direct Facility Termination	<i>DFT</i> . See Personal Line .
Direct Inward Dial	See DID .
Direct-Line Console	See DLC .
Direct Station Selector	See DSS .

Display Buttons	Buttons on an MLX display telephone used to access the telephone's display.
DLC	<i>Direct-Line Console.</i> Telephone used by a system operator to answer outside calls (not directed to an individual or a group) and inside calls, to transfer calls, to make outside calls for users with outward calling restrictions, to set up conference calls, and to monitor system operation.
DNIS	<i>Dialed Number Identification Service.</i> Service provided by AT&T and MCI to route incoming 800 or 900 calls according to customer-selected parameters, such as area code, state, or time of call.
Door Answering Unit	Device connected to a <i>tip/ring</i> jack and used at an unattended extension or front desk.
DOS	<i>Disk Operating System.</i>
Drop-and-Insert Equipment	Device that can be installed between systems connected by <i>tandem PRI trunks</i> or T1-Emulated <i>tandem tie trunks</i> to allow fractional use of the facility—that is, use of fewer than 23 of the PRI <i>B-channels</i> or fewer than 24 of the T1 <i>channels</i> . In a PRI facility, the equipment must never drop Channel 24, the <i>D-channel</i> . All channels must still be programmed and all count towards the system maximum of 80 lines.
DS0	<i>Digital Signal 0.</i> Single 64-kbps voice or data channel.
DS1	<i>Digital Signal 1.</i> Bit-oriented signaling interface that multiplexes twenty-four 64-kbps channels into a single 1.544-mbps stream.
DSL	<i>Digital Subscriber Line.</i> Digital Subscriber Line provides full-duplex service on a single twisted metallic pair (2-wire) at a rate sufficient to support ISDN Basic Rate Access.
DSS	<i>Direct Station Selector.</i> 60-button <i>adjunct</i> that enhances the call-handling capabilities of an MLX-20L or MLX-28D telephone used as an operator console.
DTE	<i>Data Terminal Equipment.</i> Equipment that makes the endpoints in a connection over a data connection—for example, a data terminal, personal computer, host computer, or printer.
DTMF signaling	<i>Dual-Tone Multifrequency Signaling.</i> Touch-tone signaling from telephones using the voice transmission path. DTMF signaling provides 12 distinct signals, each representing a dialed digit or character, and each composed of two voiceband frequencies.

E

E&M Signaling	Trunk supervisory signaling, used between two communications systems, in which signaling information is transferred through two-state voltage conditions (on the Ear and Mouth leads) for analog applications and through two <i>bits</i> for digital applications. See also Tie Trunk .
EIA	<i>Electronic Industries Association</i> .
EIA-232-D	Physical interface, specified by the <i>EIA</i> , that transmits and receives asynchronous data at speeds of up to 19.2-kbps over cable distances of 50 feet (15 meters).
Electronic Switching System	See ESS .
Endpoint	Final destination in the path of an electrical or telecommunications signal.
Enhanced Service Center	Application that sends calls to available agents in a calling group. The Enhanced Service Center places calls in queue, plays announcements, tracks agent activity and availability, and provides real-time reports.
ESF	<i>Extended Superframe Format</i> . <i>PRI</i> framing format consisting of individual frames of 24 eight-bit slots and one signal bit (193 bits) in a 24-frame extended superframe.
ESS	<i>Electronic Switching System</i> . Class of central office (<i>CO</i>) switching systems developed by Lucent Technologies in which the control functions are performed principally by electronic data processors operating under the direction of a stored program.
ETR Telephone	Enhanced tip/ring telephones (Series 4) supported in MERLIN LEGEND Release 7.0 and later.
Expansion Carrier	Carrier added to the control unit when the basic carrier cannot house all of the required modules. Houses a power supply module and up to six additional modules.
ExpressRoute 1000	Data communications device that allows connection between an RS-232 <i>DTE</i> device and the control unit, using MLX extension jacks on an MLX module.
Extended Superframe Format	See ESF .
Extension	<i>Endpoint</i> on the internal side of the communications system. An extension can be a telephone with or without an adjunct. Also called "station." See also Data Workstation .
Extension Jack	An analog, digital, or <i>tip/ring</i> physical interface on a module in the control unit for connecting a telephone or other device to the system. Also called "station jack."

Extension Programming Programming performed at an extension to customize telephones for personal needs; users can program features on buttons, set the telephone ringing pattern, and so on. See also [Centralized Telephone Programming](#) and [System Programming](#).

F

Facility Equipment (often a *line/trunk*) constituting a telecommunications path between the system and the telephone company central office (CO).

Facility Restriction Level See [FRL](#).

Factory Setting Default state of a device or feature when an optional setting is not programmed by the user or system manager.

Fax *Facsimile*. Scanning and transmission of a graphic image over a telecommunications facility, or the resulting reproduced image, or the machine that does the scanning and transmitting.

Fax Attendant System Fax-handling and processing application available with *AUDIX Voice Power*.

FCC *Federal Communications Commission*.

Feature Function or service provided by the system.

Feature Code Code entered on a dialpad to activate a feature.

Feature Module Prior to Release 3.0, circuit pack inserted into the *processor module*, used to provide system features and replaced when the system is upgraded.

Feature Screen Display screen on MLX display telephones; provides quick access to commonly used features.

Ferrite Core Attachment to the AC power cord and ground wire of the carrier power supply for compliance with FCC, part 15 requirements.

Flash ROM Beginning with Release 3.0, type of read-only memory provided on the *processor module*, used to supply system features.

Foil Shield Copper foil sheet (for power units), used to prevent excessive noise on the module.

Forced Idle Condition of the system during certain programming or maintenance procedures; system prevents initiation of new calls.

Foreign Exchange See [FX](#).

Fractional-T1 A digital transmission facility consisting of at least one, and fewer than 24, *DS0* channels using robbed-bit signaling, and connecting a *PBX* and a *central office* or toll office.

Frame	One of several segments of an analog or digital signal that has a repetitive characteristic. For example, a <i>DS1</i> frame consists of a framing <i>bit</i> and 24 bytes, which equals 193 bits.
Framing Format	Pattern of <i>frames</i> used in transmissions.
Frequency Generator	See Ring Generator .
FRL	<i>Facility Restriction Level</i> . Calling restriction type that restricts calls to certain specified <i>ARS</i> and <i>UDP</i> routes.
FX	<i>Foreign Exchange</i> . <i>Central office</i> other than the one that is providing local access to the public telephone network.

G

General Purpose Adapter	See GPA .
Glare	Condition that occurs when a user tries to call out on a <i>loop-start line</i> at the same time that another call arrives on the same line.
GPA	<i>General Purpose Adapter</i> . Device that connects an analog multiline telephone to optional equipment, such as an answering machine or a fax machine.
Ground-Start Trunk	Trunk on which the communications system, after verifying that the trunk is idle (no ground on tip lead), transmits a request for service (puts ground on ring lead) to the telephone company <i>central office</i> .
Group IV (G4) Fax Machine	Fax unit, offering 400 by 100 dots per inch (DPI) in fine mode, that can operate at any speed for communication with a Group III (G3) fax machine or another Group IV (G4) fax machine.
Group Videoconferencing System	System application that allows face-to-face, simultaneous video and voice communications between groups and requires high-speed data transmission facilities. See also Desktop Videoconferencing System .

H

Hands-Free Answer on Intercom	See HFAI .
Hands-Free Unit	See HFU .
Headset	Lightweight earpiece and microphone used for hands-free telephone operation.
HFAI	<i>Hands-Free Answer on Intercom</i> . Feature that allows a user to answer a voice-announced call.

HFU	<i>Hands-Free Unit.</i> Unit for analog multiline telephones that allows users to make and receive calls on the speakerphone without using the handset.
Home Screen	Display normally shown on an MLX display telephone; shows time, date, and call information, as well as when some features are in use.
Host	Telephone company or other switch providing features and services to the system users, usually when the system is operating in <i>Behind Switch mode</i> .
Hub System	In a <i>private network</i> that is arranged in a <i>star configuration</i> , the communications system through which all calls across the network pass.
Hybrid/PBX Mode	One of three modes of system operation in which the system uses line/trunk <i>pools</i> and <i>ARS</i> in addition to <i>personal lines</i> . Provides a single interface (SA buttons) to users for both internal and external calling. See also Behind Switch Mode and Key Mode .

I

ICLID	<i>Incoming Call Line Identification.</i> See Caller ID .
ICOM Buttons	<i>Intercom Buttons.</i> Telephone buttons that provide access to inside system lines for calling other extensions or receiving calls from them.
Immediate-Start Tie Trunk	<i>Tie trunk</i> on which no start signal is necessary; dialing can begin immediately after the trunk is seized.
In-Band Signaling	See Robbed-Bit Signaling .
Inside Dial Tone	Tone users hear when they are off-hook on an SA or ICOM button.
Inspect Screen	Display screen on an MLX display telephone that allows the user to preview incoming calls and view a list of the features programmed on line buttons.
Integrated Administration	Capability of <i>IS III</i> that simplifies the programming of common information for the system, <i>AUDIX Voice Power</i> , and, if it is also installed, <i>Fax Attendant System</i> .
Integrated Services Digital Network	See ISDN .
Integrated Solution II/III	See IS II/III .
Integrated Voice Power Automated Attendant	<i>IS II</i> application that automatically answers incoming calls with a recorded announcement and directs callers to a department, an extension, or the system operator.
Intercom Buttons	See ICOM Buttons .

Interface	Hardware and/or software that links systems, programs, or devices.
Intersystem Calls	In a <i>private network</i> , calls between a local extension and a <i>local</i> or <i>non-local dial plan</i> extension.
Intuity	Set of integrated applications that provides voice mail, fax messaging, Automated Attendant, call accounting, and system programming.
Intuity CONVERSANT	Voice response application that automatically answers and routes calls and executes telephone transactions.
I/O Device	<i>Input/Output Device</i> . Equipment that can be attached to a computer internally or externally for managing a computer system's input and output of information.
IROB Protector	<i>In-Range Out-of-Building protector</i> . Surge-protection device for off-premises telephones at a location within 1000 feet (305 meters) of cable distance from the control unit.
IS II/III	<i>Integrated Solution II or Integrated Solution III</i> . Set of UNIX System-based applications that augments and provides additional services using the system. IS II and III are no longer available.
ISDN	<i>Integrated Services Digital Network</i> . Public or private network that provides end-to-end digital connectivity for all services to which users have access by a limited set of standard multipurpose user and <i>network interfaces</i> ; provides digital circuit-switched or packet-switched connections within the network and to other networks for national and international digital connectivity.
ISDN 7500B Data Module	Data communications device that allows connection between an RS-232 <i>DTE</i> device and the control unit by MLX extension jacks on an MLX module.
ISDN Terminal Adapter	<i>Integrated Services Digital Network Terminal Adapter</i> . A device that connects the communications system with <i>data terminal equipment (DTE)</i> .
ISDN Terminal Adapter Data Station	Type of data station that includes an ISDN terminal adapter as its DCE. It may also include an MLX telephone for simultaneous voice and data (ISDN terminal adapter data-only station). These data stations connect to MLX extension jack modules for digital transmission of data over a DS1 facility.
J	
Jack	Physical connection point to the system for a telephone, line/trunk, or other device. Also called "port."

K

kbps	<i>kilobits per second.</i>
Key Mode	One of three modes of system operation, in which the system uses personal lines on line buttons for outside calls, with a separate interface (<i>ICOM buttons</i>) for inside calling. See also Behind Switch Mode and Hybrid/PBX Mode .

L

LAN	<i>Local Area Network.</i> Arrangement of interconnected personal computers or terminals, which sometimes access a host computer, and sometimes sharing resources such as files and printers.
LDN	<i>Listed Directory Number.</i>
LED	<i>Light-Emitting Diode.</i> Semiconductor device that produces light when voltage is applied; light on a telephone.
Line	Connection between extensions within the communications system; often, however, used synonymously with <i>trunk</i> .
Line and Trunk Assignment	Assignment of lines and trunks connected to the system control unit to specific buttons on each telephone.
Line Coding	Pattern that data assumes as it is transmitted over a communications channel.
Line Compensation	Adjustment for the amount of cable loss in decibels (dB), based on the length of cable between a 100D module and a channel service unit (<i>CSU</i>) or other far-end connection point.
Line/Trunk	Refers to inside system lines and outside lines/trunks in general terms. See also Line and Trunk .
Line/Trunk Jack	Physical interface on a module in the control unit for connecting an outside line/trunk to the communications system. Also called "trunk jack."
Line/Trunk and Extension Module	Module on which the jacks for connecting central office lines/trunks and/or the jacks for connecting the extensions are located.
Local Dial Plan	In a system that is part of a <i>private network</i> , list of extension ranges that the local system refers to in order to route local <i>intersystem calls via UDP</i> .
Local Extension	In a system that is part of a <i>private network</i> , extension that is listed in the system's <i>local dial plan</i> .
Local Host Computer Access	Method for connecting an extension jack to an on-site computer for data-only calls through a <i>modem</i> or <i>ISDN terminal adapter</i> .
Local Loop	The two-way connection between a customer's premises and the <i>central office</i> .

Local User	In a <i>private network</i> , person whose extension is connected to the local control unit.
Logical ID	Unique numeric identifier for each <i>extension</i> and <i>line/trunk jack</i> in the system control unit.
Loop-Start Line	Line on which a closure between the tip and ring leads is used to originate or answer a call. High-voltage 20-Hz AC ringing current from the <i>central office</i> signals an incoming call.
Lucent Technologies Attendant	Application with equipment that connects to one or more <i>tip/ring</i> (T/R) extension jacks and automatically answers incoming calls with a recorded announcement; directs calls in response to touch tones. This application is no longer available.

M

Magic On Hold	Lucent Technologies Music-On-Hold enhancement that promotes a company's products or services.
mbps	<i>megabits per second</i> .
Megacom	AT&T tariffed digital <i>WATS</i> offering for outward calling.
Megacom 800	AT&T tariffed digital 800 offering for inward calling.
Memory Card	Storage medium, similar in function to a floppy disk, that allows information to be added to, or obtained from, the communications system through the PCMCIA interface slot on the processor module.
MERLIN Identifier	<i>Adjunct</i> that allows users to receive, store, and use information provided by Caller ID.
MERLIN LEGEND Mail	Voice-messaging system that provides Automated Attendant, call answering, and voice-mail services. It is housed in its own module.
MERLIN Mail	Voice-messaging system that provides Automated Attendant, call answering, and voice-mail services. No longer available.
Messaging 2000	Voice-messaging system housed in a PC that connects to <i>tip/ring</i> ports on the system's modules. Messaging 2000 provides voice mail, Automated Attendant, call answering, and fax messaging services.
MFM	<i>Multi-Function Module</i> . Adapter that has a <i>tip/ring</i> mode for answering machines, modems, fax machines, and <i>tip/ring</i> alerts, and an <i>SAA</i> mode for -48 VDC alerts. It is installed inside an MLX telephone and is used to connect optional equipment to the telephone. The optional equipment and the telephone operate simultaneously and independently.

MLS Telephone	An enhanced <i>tip/ring</i> (Series 3) telephone supported in MERLIN LEGEND Release 7.0 and later. No longer available.
MLX Telephone	Multiline button telephone that transmits and receives digital signals.
Mode Codes	Streams of touch-tone codes used by voice messaging applications to communicate with the system's control unit.
Modem	Device that converts digital data signals to analog signals for transmission over a telephone line, and analog signals received on a telephone line to digital signals.
Modem Data Station	Type of data station that includes a modem as its DCE. It may also include an MLX telephone for simultaneous voice and data (MLX voice and modem data station), an analog multiline telephone (analog voice and modem data station), or a single-line telephone for dialing only (modem data-only station). These data stations connect respectively to MLX, analog, or <i>tip/ring</i> extension jack modules. They provide analog transmission of data.
Modem Pool	Pair, or group of pairs, of <i>modems</i> and data modules with interconnected RS-232 interfaces that converts digital signals to analog, or analog signals to digital, thereby allowing users with <i>ISDN terminal adapter data stations</i> to communicate with users who have analog <i>modem data stations</i> .
Module	Circuit pack in the control unit that provides the physical jacks for connecting telephones and/or outside lines/trunks to the communications system. In the name of a module, the first digit indicates the number of <i>line/trunk jacks</i> it contains; the last digit indicates the number of <i>extension jacks</i> it contains. If no letters appear after the number, a line/trunk module provides <i>loop-start lines</i> or an extension jack module provides analog or <i>tip/ring</i> jacks. For example, a 408 GS/LS-MLX module contains four line/trunk jacks and eight digital (MLX) extension jacks, and provides either <i>loop-start</i> (LS) or <i>ground-start</i> (GS) <i>trunks</i> .
Monitored Extension	Extension for which one or more CTI applications is receiving call information. The CTI application does not have to be directly attached to the equipment at the extension in order to monitor calls. The call information may appear on the PC screen of another extension that has been programmed to receive it. See also CTI Link and Unmonitored Extension .
Multi-Function Module	See MFM .
Multiline Telephone	Analog or digital (MLX) telephone that provides multiple line buttons for making or receiving calls or programming features.

Multiplexing Division of a transmission channel into two or more independent channels—either by splitting the frequency band into a number of narrower bands or by dividing the channel into successive time slots.

Music-On-Hold Customer-provided music source or Magic On Hold connected to the system through a *loop-start* jack.

N

Network Configuration of communications devices and software connected for information interchange.

Network Interface Hardware, software, or both that links two systems in an interconnected group of systems—for example, between the local telephone company and a PBX.

NI-1 BRI *National Integrated Services Digital Network 1 Basic Rate Interface*. Type of digital facility that carries the equivalent of three lines. Two are called *B-channels* and provide voice and data communications services. A third *D-channel* controls signaling and maintains operations on the B-channels.

Non-Local Dial Plan In a system that is part of a *private network*, list of extension ranges that the local system references in order to route non-local *intersystem calls via UDP*.

Non-Local Extension In a system that is part of a *private network*, extension that is in the *non-local dial plan*.

Non-Local User In a *private network*, user who is connected to another system in the network and not to the local system.

Non-Satellite System In a *private network, communications system* that is directly connected to and located more than 200 miles from the local system.

O

Off-Hook Telephone is said to be off-hook when the user has lifted the handset, pressed the Speakerphone button to turn on the speakerphone, or used a headset to connect to the communications system or the telephone network.

Off-Premises Telephone See [OPT](#).

Ones Density Requirement for channelized *DS1* service to the public network that prohibits eight consecutive zeros in a digital data stream.

On-Hook Telephone is said to be on-hook when the handset is hung up, the speakerphone is turned off, and the user is not using a headset to connect to the communications system or the telephone network.

OPT	<i>Off-Premises Telephone. Single-line telephone or other tip/ring device connected to the system via a 008 OPT module in the control unit. Appears as an inside extension to the system, but may be physically located away from the system.</i>
OPX	<i>Off-Premises Extension.</i>
Out-of-Band Signaling	Signaling that uses the same path as voice-frequency transmission and in which the signaling is outside the band used for voice frequencies.

P

Parity	Addition of a <i>bit</i> to a bit string so that the total number of ones is odd or even; used to detect and correct transmission errors.
PassageWay Direct Connection Solution	Set of software applications that provides an interface between a personal computer and an MLX telephone.
PBX	<i>Private Branch Exchange.</i> Local electronic telephone switch that serves local stations (for example, extensions within a business) and provides them with access to the public network.
PC	<i>Personal Computer.</i>
PCMCIA Memory Card	<i>Personal Computer Memory Card International Association Memory Card.</i> See Memory Card .
Peripheral System	In a <i>private network</i> , system that does not connect to more than one other system, sometimes called an "end node."
Personal Line	<i>Central office</i> line/trunk that terminates directly at one or more extensions. In <i>Hybrid/PBX mode</i> , a personal line cannot be part of a line/trunk <i>pool</i> . Also called "DFT" (Direct Facility Termination).
PFT	<i>Power Failure Transfer.</i> Feature that provides continuity of telephone service during a commercial power failure by switching some of the system's line/trunk connections to telephones connected to specially designated extension jacks.
Phantom Extension	Extension that is not actually plugged into the system, but is used, for example, as a calling group member covered by a <i>voice messaging system</i> .
Pool	In <i>Hybrid/PBX mode</i> , a group of outside lines/trunks that users can access with a Pool button or by dialing an access code on an SA <i>button</i> . Also used by the ARS feature when choosing the least expensive route for a call.
Point-to-Point Facility	In a <i>private network</i> , a line/trunk that passes through the PSTN without using the switching capabilities of the PSTN.

Port	See Jack . Also, refers to <i>extension</i> or <i>line/trunk jacks</i> before these are numbered according to the <i>dial plan</i> during programming. The lowest jack on a module is always Port 1.
Power Failure Transfer	See PFT .
Power Supply Module	Device that directs electricity to modules and telephones on the system. One power supply module is needed for each carrier, and an <i>auxiliary power unit</i> is added, if needed.
PRI	<i>Primary Rate Interface</i> . Standard interface that specifies the protocol used between two or more communications systems. As used in North America, it provides twenty-three 64-kbps <i>B-channels</i> for voice and/or data and one 16-kbps <i>D-channel</i> , which carries multiplexed signaling information for the other 23 channels.
Primary System Operator Position	First <i>jack</i> on the first MLX or analog multiline extension module in the control unit—that is, the extension jack with the lowest logical ID in the system.
Prime Line	Individual extension number assigned to a telephone in a system operating in <i>Behind Switch mode</i> . Each telephone user has his or her own prime line and is automatically connected to that line when he or she lifts the handset.
Priority Call Queuing	System function that prioritizes calling groups, thereby allowing certain incoming calls to be answered before others. Available in Release 7.0 and later systems.
Private Communications Network	See Private Network .
Private Network	Interconnected group of <i>communications systems</i> , which may consist of MERLIN LEGEND Communications Systems, DEFINITY Enterprise Communications Servers (ECS), and/or DEFINITY ProLogix Solutions.
Private Network Trunks	Facilities that connect <i>communications systems</i> in a <i>private network</i> . See also Tandem Tie Trunk and Tandem PRI Trunk .
Processor Module	Module in the second slot of the control unit (Slot 0, to the right of the <i>power supply module</i>). Includes the software and memory that runs the system.
Programming Port Reassignment	Reassignment of the system programming jack position to any of the first five extension jacks on the first MLX module in the control unit.
Protocol	Set of conventions governing the format and timing of message exchanges between devices, such as an MLX telephone and the control unit.
PSTN	<i>Public Switched Telephone Network</i> . Network that is commonly accessible for local or long-distance calling. Also called “public network” or “public switched network.”

PSTN Trunk In a *private network*, facility that connects a networked system to the *public switched telephone network*.

Public switched Telephone Network See [PSTN](#).

Q

QCC *Queued Call Console*. MLX-20L telephone used by a system operator in *Hybrid/PBX mode* only. Used to answer outside calls (directed to a system operator position) and inside calls, to direct inside and outside calls to an extension or to an outside telephone number, to serve as a message center, to make outside calls for users with outward calling restrictions, to set up conference calls, and to monitor system operation.

R

RAM *Random-Access Memory*. Computer memory in which an individual *byte* or range of bytes can be addressed and read or changed without affecting other parts of memory.

Read-Only Memory See [ROM](#).

Remote Access System feature that allows an outside caller to gain access to the system, almost as if at a system extension. In a *private network*, remote access settings are used to control calls routed via *ARS* or *UDP* routing across the network.

Restore Procedure whereby saved and archived system programming is reinstated on the system, from a floppy disk or *memory card*. See also [Backup](#).

Restricted Data Channel Channels that do not allow the transmission of occurrences of more than seven contiguous zero bits. See also [Unrestricted Data Channels](#).

Ring Generator Circuit pack added to the power supply that generates a high-voltage, 20–30 Hz signal to ring a telephone.

Rotary Dial Enable Through centralized programming, T/R ports (including the T/R ports on the new ETR modules) can be programmed to accept rotary-dial and touch-tone digits or just touch-tone digits. Available in Release 7.0 and later systems.

Riser Cable Cable that runs between floors in a multi-story building and connects wiring closets.

RS-232 Physical interface, specified by the Electronics Industries Association (EIA), that transmits and receives asynchronous data at distances of up to 50 feet (15 meters).

Robbed-Bit Signaling	Signaling in which the least significant <i>bit</i> of every sixth <i>frame</i> per channel is used for signaling in that channel.
ROM	<i>Read-Only Memory</i> . Computer memory that can be read, but cannot be changed.

S

SAA	<i>Supplemental Alert Adapter</i> . Device that permits alerting equipment to be connected to an analog multiline telephone <i>jack</i> so that people working in noisy or remote areas of a building can be alerted to incoming calls.
SA buttons	Telephone buttons that provide access to both inside and outside calls.
Satellite System	In a <i>private network</i> , a <i>communications system</i> that is directly connected to, and located within 200 miles of the local system.
Screen Pop	Refers to a computer-telephony software application that takes caller information (for example, the calling party number provided by Caller ID service), queries a database, and displays a screen with information about the caller onto a user's PC screen. Screen pop requires that an identifying number or code be available to identify the calling party. See also CTI Link .
SDN	<i>Software Defined Network</i> . AT&T private networking service created by specialized software within the public network.
Series Configuration	<i>Private network</i> arrangement whereby either two or four or more communications systems are connected in a line, with no particular system acting as the <i>hub system</i> . See also Star Configuration .
Service Observing	Feature available in Release 6.1 and later systems that allows one extension to listen in on (observe) calls that arrive at another extension.
SID	<i>Station (Extension) Identification</i> .
Signaling	Sending of information between devices to set up, maintain, or cease a connection, such as a telephone call.
Simplex Signaling	Transmission of signals in one direction only, across a telecommunications channel.
Single-Line Telephone	Industry-standard touch-tone or rotary dial telephone that handles one call at a time. It is connected to the system via an <i>extension jack</i> on an 012 (T/R), 016 (T/R), or 008 OPT module; or, in Release 7.0 and later systems, via a <i>port</i> on a 412 LS-ID-ETR or 016 ETR module programmed for <i>tip/ring</i> operation.
Slot	Position in a carrier for a module; numbered from 0.

SMDR	<i>Station Message Detail Recording.</i> Feature that captures usage information on incoming and outgoing calls.
SMDR Printer	Printer used to produce <i>SMDR</i> reports. Connected to the system via an RS-232 <i>jack</i> on the <i>processor module</i> .
Software Defined Network	See SDN .
Special Character	Pause, Stop, or End-of-Dialing signal in a programmed dialing sequence, such as a speed dial number.
SPM	<i>System Programming and Maintenance.</i> DOS-, UNIX-, or Windows-based application for programming the system.
Square Key	Configuration in <i>Key mode</i> operation in which all outside lines appear on all telephones.
Star Configuration	<i>Private network</i> arrangement whereby either three or more communications systems are connected with one system acting as the <i>hub system</i> . See also Series Configuration .
Station	See Extension .
Station Jack	See Extension Jack .
Station Message Detail Recording	See SMDR .
Supplemental Alert Adapter	See SAA .
Switch	See Communications System .
Switched 56 Service	<i>DS1 Switched 56</i> service is an end-to-end digital, 56-kbps, full-duplex, synchronous, circuit-switched service offering. The service is offered by network service providers and by some Local Exchange Carriers (LECs) as circuit-switched, 56-kbps service. T1-emulated <i>tandem tie trunks</i> in a <i>private network</i> can be programmed for data.
Switchhook Flash	Momentary (320 ms to 1 sec) on-hook signal used as a control; may be directed to the control unit or to a <i>host</i> switch outside the system. Also called "Recall" or "timed flash."
Switch Identifier	Number assigned to a <i>tandem trunk</i> in a <i>private network</i> . It identifies the system connected to the far end of the trunk. A switch identifier is based on the type of system and its distance from the system where the identifier is assigned. See also Satellite System and Non-Satellite System .
Synchronous Data Transmission	Method of transmitting a continuous digital data stream in which the transmission of each binary <i>bit</i> is synchronized with a master clock. See also Asynchronous Data Transmission .
System Acceptance Test	Test of all trunks, telephones, data terminals, and features after installation to ensure that they are working correctly.
System Access Buttons	See SA buttons .

System Date and Time	Date and time that appear on MLX display telephones and <i>SMDR</i> reports.
System Programming	Programming of system functions and features that affect most users, performed from an MLX-20L telephone or a computer using <i>SPM</i> . See also Extension Programming and Centralized Telephone Programming .
System Programming and Maintenance	See SPM .
System Renumbering	Procedure used to change the numbers assigned to telephones, <i>adjuncts</i> , <i>calling groups</i> , paging groups, park zones, <i>Remote Access</i> , and lines/trunks.

T

T1	Type of digital transmission facility that, in North America, transmits at the <i>DS1</i> rate of 1.544 mbps.
T1-Emulated Data	A T1 <i>tie trunk</i> programmed for S56DATA for use by data calls at speeds up to 56 kbps. These trunks may be used for tandem and non-tandem operation.
T1-Emulated Voice	A T1 <i>tie trunk</i> programmed for Tie-PBX or Tie-Toll for use by voice calls.
T1 Switched 56 Service	<i>T1</i> digital data transmission over the <i>public network</i> or over a <i>private network</i> at 56 kbps. See Switched 56 Service .
Tandem Switching	Capability of <i>private network</i> communications systems that allows them to direct outside calls from one facility to another, rather than just to an extension. Calls may be sent, for example, from a <i>PSTN</i> facility to a <i>tandem trunk</i> , or vice versa.
Tandem Trunk	Private outside facility (as opposed to an inside system line) that connects two communications systems in a <i>private network</i> and can carry calls to another outside facility through <i>tandem switching</i> . The trunk is not connected to the <i>PSTN</i> .
Tandem Tie Trunk	<i>Tandem trunk</i> that is an analog <i>delay-start tie trunk</i> , providing a single line/trunk per facility and allowing <i>analog transmission</i> of voice and low-speed data; or a T1 facility offering 24 channels on emulated tie trunks and programmed for voice or data.
Tandem PRI Trunk	<i>Tandem Primary Rate Interface Trunk</i> . <i>Private network trunk</i> .
TAPI	<i>Telephony Application Programming Interface</i> . Application programming interface that allows computer telephony applications to be used. TAPI is not yet supported by the MERLIN LEGEND Communications System. See also TSAPI and CTI Link .

Telephone Power Supply Unit	Equipment that provides power to an individual telephone.
Terminal Adapter	See ISDN Terminal Adapter .
Tie Trunk	Private trunk directly connecting two telephone switches.
Timed Flash	See Switchhook Flash .
Tip/Ring	Contacts and associated conductors of a <i>single-line telephone</i> plug or jack.
Touch-Tone Receiver	See TTR .
T/R	See Tip/Ring .
Trunk	Telecommunications path between the communications system and the telephone company <i>central office</i> or another switch. Often used synonymously with <i>line</i> .
Trunk Jack	See Line/Trunk Jack .
Trunk Pool	See Pool .
TSAPI	<i>Telephony Services Application Programming Interface</i> . Application programming interface that allows computer telephony applications to be used. TSAPI is supported by the MERLIN LEGEND Communications System, Release 5.0 and later. See also TAPI and CTI Link .
TTR	<i>Touch-Tone Receiver</i> . Device used to decode <i>DTMF</i> touch-tones dialed from <i>single-line</i> or <i>Remote Access</i> telephones.

U

UDP	<i>Uniform Dial Plan</i> . Composed of the <i>local dial plan</i> and <i>non-local dial plan</i> . A dial plan that allows a caller at any <i>extension</i> in a <i>private network</i> to dial the same number of digits to reach any other extension in the private network, even if the originating extension is physically connected to one communications system and the terminating extension is physically connected to a different communications system.
Unambiguous Numbering	Practice of numbering of extension ranges, remote access codes, or other system components to avoid routing conflicts in network or local calling. For example, Extension 441 is unique when compared to Extension 4410; however, this is ambiguous, because the system routes as soon as it matches the digits sent for a call with the digits in a <i>local dial plan</i> or in a <i>non-local dial plan</i> extension range. When a caller dials 4410, therefore, the system routes the call to Extension 441 without considering the last dialed digit.
Uniform Dial Plan	See UDP .
Uninterruptible Power Supply	See UPS .

Unit Load	Measure of the power load drain of a module, telephone, or <i>adjunct</i> .
Unmonitored Extension	<i>Extension</i> for which no CTI application is receiving call information. See also CTI Link and Monitored Extension .
Unrestricted Data Channels	Also called <i>Clear Data Channels</i> . Allow the transmission of occurrences of more than seven contiguous zero bits. If an unrestricted data channel is requested and only restricted channels are available, the call will be rejected. See also Restricted Data Channel .
UPS	<i>Uninterruptible Power Supply</i> . Device that connects to the system to provide 117 VAC to the equipment when the commercial power source fails.

V

VAC	<i>Alternating Current Voltage</i> .
VDC	<i>Direct Current Voltage</i> .
VMI	<i>Voice Messaging Interface</i> . Enhanced <i>tip/ring</i> port.
Videoconferencing System	System application that allows face-to-face meetings, with voice and video, between individuals or groups. This application requires high-speed data transmission facilities. See also Desktop Videoconferencing System and Group Videoconferencing System .
Virtual Private Network	See VPN .
VPN	<i>Virtual Private Network</i> . Type of <i>private network</i> that uses the switching capabilities of the <i>PSTN</i> , rather than <i>tandem switching</i> , to direct calls between connected communications systems. A VPN may constitute a part of a private network.
Voice Announce	System feature that allows users to receive voice announcements on their telephones. In Release 7.0 and later systems, the VA On Idle Only option (only for MLX telephones) allows voice announcement calls to go through only when the telephone is idle.
Voice-Band Channel	Transmission channel, generally in the 300–3400-Hz frequency band.
Voice Mail	Application that allows users to send messages to other system extensions, to forward messages received with comments, and to reply to messages.
Voice Messaging Interface	See VMI .

W

WATS

Wide Area Telecommunications Service. Service that allows calls to certain areas for a flat-rate charge based on expected usage.

Wink-Start Tie Trunk

Tie trunk on which the originating end transmits an off-hook signal and waits for the remote end to send back a signal (a wink) that it is ready for transmission.

Index

Numerics

- 008 MLX module, [2-3](#), [2-4](#)
 - 008 module, [6-2](#)
 - 008 OPT module, [liii](#), [2-32](#)
 - AUDIX Voice Power, [2-32](#), [2-34](#)
 - extension capacity, [2-3](#)
 - MERLIN Mail voice messaging system, [2-34](#)
 - 012 module, [liii](#)
 - 016 ETR module
 - applications, [2-16](#)
 - REN, [2-5](#)
 - tip/ring operation, [6-2](#)
 - TTRs, [2-19](#)
 - 016 T/R module, [2-5](#), [2-32](#)
 - ringing frequency, [2-32](#), [2-35](#)
 - 100D module, [3-4](#)
 - 2-digit numbering plan, [2-37](#)
 - 3-digit numbering plan, [2-37](#)
 - 408 GS/LS MLX module, [6-2](#)
 - jacks, [3-2](#)
 - Power Failure Transfer (PFT) feature, [2-6](#)
 - 408 GS/LS-ID-MLX
 - Caller ID, [3-3](#)
 - 408 GS/LS-MLX module, [lvij](#), [6-2](#)
 - ports, [2-15](#)
 - 408 module, [6-2](#)
 - 412 LS-ID-ETR module
 - applications, [2-16](#)
 - REN, [2-5](#)
 - tip/ring operation, [6-2](#)
 - TTRs, [2-19](#)
 - 4ESS, [3-24](#), [D-1](#)
 - 5ESS, [lvii](#), [3-24](#), [D-1](#)
 - 5ESS Local, [3-36](#)
 - 800 LS-ID module, [xlvi](#)
 - 800 NI-BRI module, [2-5](#), [3-3](#), [3-6](#)
-

A

- Absorb digits, [4-69](#)
- Account Code Entry, [5-33](#)
- ACCUNET Switched Digital Services, [3-4](#)
- ACCUNET Switched Digital Services (SDS), [D-1](#)
- Adding to the system, [6-2](#)
- Adjuncts, system
 - assigning buttons, [3-60](#)
 - features, [4-3](#)
 - numbering, [2-28](#)
 - Queued Call Console (QCC), [4-3](#)

Alert

external, [4-34](#)

Allowed Lists, [4-49](#)

American Society of Composers, Artists, and Producers (ASCAP), [3-10](#)

Analog multiline telephones

and Delay Announcement Units, [2-29](#)

button assignments (Hybrid/PBX mode), [3-61](#)

button assignments (Key/Behind Switch mode), [3-63](#)

Extension Copy feature, [4-9](#)

jacks, [2-29](#)

Analog voice and modem data stations

lines/trunks, [5-7](#)

Answer supervision time, [3-43](#)

Applications

AUDIX Voice Power/Fax Attendant, [2-32](#)

CONVERSANT, [2-33](#)

Enhanced Service Center (ESC), [2-33](#)

Integrated Solution II (IS II), [2-34](#)

Integrated Solution III (IS III), [2-34](#)

Intuity AUDIX, [2-33](#)

jacks, [2-32](#)

Lucent Attendant, [2-33](#)

MERLIN LEGEND Mail, [2-33](#)

MERLIN Mail voice messaging system, [2-33](#)

Messaging 2000, [2-33](#)

planning for, [2-12](#)

AT&T Switched Network (ASN), [3-4](#)

AT&T Toll, [3-36](#)

AUDIX Voice Power, [lv](#), [lvi](#)

AUDIX Voice Power/Fax Attendant System

008 OPT module, [2-17](#)

coverage group, [4-29](#)

ports, [2-32](#)

renumbering, [2-36](#)

reserved extensions, [4-30](#)

Authorization Codes, [l](#)

Auto Answer All, [5-33](#)

Auto Dial button, [lii](#)

Automatic backup, [2-11](#)

Automatic Callback, [3-18](#), [3-19](#), [4-43](#)

Automatic Hold or Release, [4-18](#)

Automatic Maintenance Busy, [2-10](#)

Automatic Route Selection (ARS), [5-34](#)

absorb digits setting, [4-71](#)

area code/exchanges, [4-59](#)

button assignments, [3-59](#)

call types, [4-71](#)

description, [4-59](#)

Facility Restriction Levels (FRLs), [4-67](#)

other digits setting, [4-71](#)

pools, [4-69](#)

preferred trunk pools, [4-59](#)

subpatterns, [4-67](#)

tables, [4-62](#)

type of dialing, [4-59](#)

worksheet, [4-59](#)

Auxiliary equipment, [6-3](#)

B

- Backing up the system, system programming, [2-11](#)
- Barrier codes, [1](#), [3-18](#), [3-20](#)
- B-channel groups, [3-34](#)
- Behind Switch mode
 - button assignments, [3-61](#)
 - features, [2-9](#)
- BRI line options
 - Service Profile Identifier (SPID)
 - planning form instructions, [3-48](#)
- BRI line options planning, [3-46](#)
 - clock synchronization
 - planning considerations, [3-49](#)
 - Service Profile Identifier (SPID)
 - planning considerations, [3-47](#)
 - timers
 - planning considerations, [3-50](#)
 - planning form instructions, [3-51](#)
- Broadcast Music Incorporated (BMI), [3-10](#)
- Business Cordless 905, [2-16](#)
- Buttons
 - assigning, [3-58](#)
 - assigning in Behind Switch mode, [3-61](#)
 - assigning in Hybrid/PBX mode, [3-54](#)
 - assigning in Key mode, [3-61](#)
 - factory assignments, [3-61](#)

C

- Calculating unit loads, [F-2](#)
- Call Management System (CMS), [2-25](#), [2-36](#)
- Call-by-Call Service Selection, [3-4](#), [3-38](#)
- Caller ID Toggle Button, [4-10](#)
- Calling Groups
 - and dial-in trunks, [3-16](#), [4-32](#)
 - and DID trunks, [3-44](#)
 - and Incoming Call Line Identification (ICLID), [3-5](#)
 - and Pools, [3-16](#)
 - and Remote Access, [3-19](#)
 - and Tie trunks, [3-42](#)
 - interaction with Music on Hold and External Page Port trunks, [3-4](#)
- Calling groups
 - Calls-in-Queue alarm threshold, [4-33](#)
 - extension number, [4-31](#)
 - Extension Status, [4-30](#), [4-43](#)
 - external alert for, [4-34](#)
 - Hunt type, [4-33](#)
 - MERLIN LEGEND Mail, [4-31](#)
 - Message Waiting receiver, [4-33](#)
 - names, [4-31](#)
 - options, [4-33](#)
 - overflow coverage, [4-38](#)
 - overflow threshold, [4-35](#)
 - overflow time threshold, [4-38](#)

- Calling groups, (continued)
 - overview, [4-30](#)
 - types, [4-39](#)
- Calling Restrictions, [5-35](#)
- Calling restrictions, [5-34](#), [5-35](#)
 - overview, [4-4](#), [4-52](#)
- Calls-in-Queue alarm threshold, [4-33](#)
- Calls-in-Queue alert, [4-18](#)
- Camp-On, [4-42](#)
- Capacity
 - lines/trunks, [2-2](#)
- Centralized programming, [4-2](#)
- Centralized Voice Mail, [2-35](#)
- CentreVu Computer-Telephony Services for Windows NT, [2-30](#)
- Centrex, [3-4](#)
- Channel service unit (CSU), [3-28](#)
- CKE4 processor module, [7-2](#)
 - using a 016 MLX module, [7-2](#)
- Class of restriction (COR)
 - with barrier codes, [3-22](#)
 - without barrier codes, [3-21](#)
- Clock synchronization
 - 800 NI-BRI and 100D module interaction, [3-49](#)
 - NI-1 BRI service, [3-49](#)
 - planning considerations, [3-49](#)
 - Primary Rate Interface (PRI), [3-33](#)
 - T1 service, [3-27](#)
- common-channel signaling
 - 100D module and T1 option, [3-26](#)
- Computer Telephony Integration (CTI) link, [1-6](#), [2-30](#)
- Consoles, system, [2-12](#)
- Control unit
 - configuration planning, [2-1](#), [2-40](#)
 - cover, [liii](#)
 - diagram, [2-7](#)
 - extension capacity, [2-2](#)
 - line/trunk capacity, [2-2](#)
 - module placement, [2-1](#), [2-4](#)
 - operating conditions, [2-7](#)
- CONVERSANT, [2-33](#)
- Cover Ring Delay, [4-13](#)
- Coverage, [lvi](#), [2-18](#)
 - AUDIX Voice Power/Fax Attendant System, [4-29](#)
 - Cover button, [4-29](#)
 - delay interval, [4-28](#)
 - group, [4-28](#)
 - Group Cover button, [4-29](#)
 - Group Coverage calls, [4-29](#)
 - Individual Coverage, [4-26](#)
 - overview, [4-26](#)
 - primary, [4-27](#)
 - receivers, [4-26](#), [4-27](#)
 - secondary, [4-27](#)
 - senders, [4-26](#)
- Coverage delay interval, [4-28](#)
- Coverage VMS, [lvi](#), [4-56](#)
- CTI link
 - available ports, [2-27](#)
 - MLX module vintage, [1-8](#)
 - software required, [2-27](#)

D

- Data communications
 - extension jacks, [5-20](#)
- Data communications equipment, [5-3](#)
- Data forms, [C-1](#)
- Data Hunt Group, [5-3](#)
- Data stations, [5-2](#)
 - analog voice and modem data, [5-7](#)
 - buttons in Hybrid/PBX mode, [5-29](#)
 - calling restrictions, [5-34](#)
 - extension jacks, [5-1](#)
 - extension jacks for, [5-1](#)
 - GPA, [5-6](#)
 - ISDN terminal adapter data-only, [5-9](#)
 - LAN host computer, [5-13](#), [5-23](#)
 - LAN workstations, [5-13](#), [5-23](#)
 - modem data-only, [5-8](#)
- Data Status, [5-34](#)
- Data Terminal, [5-3](#)
- Data Terminal Equipment (DTE), [5-3](#)
- Date, [2-11](#)
- Delay Announcement Devices
 - connected to tip/ring jacks, [2-32](#)
 - MLX telephone adjunct, [2-26](#)
- Delay announcement devices, [2-20](#)
- Delay Announcement Units
 - Connected to analog multiline telephones, [2-29](#)
 - TTRs required, [2-22](#)
- Delay Ring interval, [4-28](#)
- DEX600, [D-1](#)
- Dial plan routing, [3-34](#)
- Dial tone, [2-19](#), [3-43](#)
 - secondary dial tone timer, [2-12](#)
- Dialed Number Identification Service (DNIS), [3-4](#)
- Digital adjuncts
 - assigning trunks, [3-53](#)
 - features, [4-3](#)
 - jacks, [2-27](#)
 - user information, [3-53](#)
- Digital Announcer Unit, [liv](#)
- Digital Signal 1 (DS1)
 - configurations summary, [3-40](#)
 - ground-start emulation, [3-4](#)
 - T1, [6-2](#)
- Direct Inward Dial (DID) trunks, [lvi](#), [5-26](#)
 - blocks and, [3-46](#)
 - dial one, [3-44](#)
 - disconnect time, [3-46](#)
 - expected digits, [3-45](#)
 - invalid destination, [3-46](#)
 - options, [3-44](#)
 - planning, [3-44](#)
 - remote access, [3-19](#), [3-44](#)
 - signaling, [3-45](#)
 - type, [3-45](#)

Direct Station Selector (DSS), [lii](#)
 buttons, [3-72](#)
 park zones, [4-23](#)
 ranges, [4-23](#)
Directed call completion, [4-20](#)
Direct-Line Console (DLC)
 Automatic Hold, [4-16](#)
 button assignment, [3-72](#), [3-74](#)
 button assignments, [3-72](#)
 definition, [2-12](#)
 Extension Copy feature, [4-9](#)
 features, [4-16](#)
 primary operator position, [2-23](#)
Disallowed Lists, [4-51](#)
Disconnect signal, [3-12](#)
Disconnect time, [3-43](#), [3-46](#)
DMS FX services, [D-1](#)
DMS INWATS services, [D-1](#)
DMS OUTWATS services, [D-1](#)
DMS Private Network services, [D-1](#)
DMS Tie Trunk services, [D-1](#)
DMS-100 Local services, [3-36](#)
DMS-100 services, [D-1](#)
DMS-250 services, [D-1](#)
Do Not Disturb, [lvi](#)

E

E&M signal, [3-42](#)
Elevate priority, [4-19](#)
Emergency Allowed List, [4-54](#)
Enhanced Service Center, [2-32](#)
Enhanced Service Center (ESC), [2-33](#)
ETR telephone
 button assignments
 Behind Switch mode, [3-66](#)
 Hybrid/PBX mode, [3-56](#)
 Key mode, [3-64](#)
ETR-6 and MLS-6 telephones
 system treatment, [3-58](#)
 system treatment in Behind Switch mode, [3-71](#)
 system treatment in Key mode, [3-70](#)
Extension Copy, [4-2](#)
Extension jacks
 data stations, [5-1](#)
 identifying, [2-14](#)
 LAN data stations, [5-13](#)
 numbers, [2-4](#), [4-25](#)
 pairs, [2-25](#)
Extension Status, [4-30](#), [4-43](#)
Extensions
 adding, [6-2](#), [6-6](#)
 assigning numbers, [2-13](#)
 capacity, [2-2](#)
 identifying jacks, [2-14](#)
 jack pairs, [2-25](#)
 labels, [2-35](#)

Extensions, (continued)
 module types, [2-15](#)
 numbering plans, [2-36](#)

F

Facility Restriction Levels (FRLs), [4-67](#)

Fax machines

 features, [4-7](#)
 message threshold, [4-7](#)
 message-waiting receiver, [4-7](#)

FCC registration

 PF registration number, [lix](#)

Features

 adding, [6-2](#)
 copying of, [4-10](#)
 group-assigned, [4-24](#)
 overview, [4-1](#)
 system, [4-40](#)
 telephone, [4-2](#)

Federal Communications Commission (FCC)

 Key mode registration, [3-7](#)
 system mode registration, [2-9](#)

Ferrite cores, [liii](#)

Flash ROM, [xlvi](#)

Forced Account Code Entry, [lii](#), [4-5](#)

Forms

 data, [C-1](#)
 system planning, [B-1](#)

Forward Delay option, [4-6](#)

Framing format, [3-26](#), [3-32](#)

FTS2000, [lvii](#)

FTS2000 network, [3-24](#)

G

General-Purpose Adapter (GPA), [5-7](#)

 analog multiline telephone connection, [2-29](#)
 data stations, [5-6](#)
 feature assignment, [5-6](#)
 requirement, [6-2](#)

Ground-start

 emulation, [3-4](#)
 lines/trunks, [5-25](#)

Ground-start trunks

 emulation, [3-4](#)

Group Calling

 and dial-in trunks, [3-16](#), [4-32](#)
 and DID trunks, [3-44](#)
 and Incoming Call Line Identification (ICLID), [3-5](#)
 and Pools, [3-16](#)
 and Remote Access, [3-19](#)
 and Tie trunks, [3-42](#)
 assigning trunks, [3-4](#)
 Delay Announcement Device, [2-26](#)

- Group Calling, (continued)
 - interaction with Music on Hold and External Page Port trunks, [3-4](#)
 - options, [4-33](#)
 - overview, [4-30](#)
 - touch-tone receivers (TTRs) required, [2-20](#)
 - Group channel assignments, [3-34](#)
 - Group Cover button, [4-29](#)
 - Group Coverage, [4-28](#)
 - Group ID, [4-26](#)
 - Group name, [4-26](#)
 - Group number, [4-25](#)
 - Group paging, [4-25](#)
 - Group Videoconferencing, [5-15](#)
-

H

- HackerTracker, [liv](#)
 - Hold
 - disconnect interval, [3-14](#)
 - return, [4-17](#)
 - timer, [4-16](#)
 - Home calling group, [4-35](#)
 - HotLine, [4-9](#)
 - Hunt type, [4-33](#)
 - Hybrid/PBX mode
 - Automatic Maintenance Busy, [2-10](#)
 - buttons for data stations in, [5-29](#)
 - calling restrictions, [5-34](#)
 - setting up, [2-9](#)
-

I

- Idle Line Preference, [5-34](#)
 - Incoming Call Line Identification (ICLID), [I](#)
 - Integrated Solution II (IS II), [2-34](#)
 - Integrated Solution III (IS III), [2-34](#)
 - Integrated Voice Power Automated Attendant, [2-34](#)
 - Interdigit timers, [4-49](#)
 - Intuity, [GL-16](#)
 - Intuity AUDIX, [2-32](#), [2-33](#)
 - INWATS, [D-1](#)
 - ISDN Terminal Adapter, [5-3](#)
-

J

- Jacks
 - additional operator positions, [2-24](#)
 - analog multiline telephones, [2-29](#)
 - applications, [2-32](#)
 - auxiliary equipment, [3-9](#)
 - CTI applications, [2-30](#)
 - data terminals, [2-27](#)
 - identifying for extensions, [2-14](#)

Jacks, (continued)

- lines/trunks, [3-1](#)
 - MLX, [2-26](#)
 - primary operator position, [2-23](#)
 - system programming, [2-8](#)
 - tip/ring (T/R) equipment, [2-32](#)
-

K

Key mode

- data stations, [5-32](#)
 - FCC registration, [3-7](#)
 - permanent, [2-9](#)
 - setting up, [2-9](#)
-

L

Labeling

- display telephones, [4-56](#)
- extensions, [2-35](#)
- Posted Messages, [4-57](#)
- System Speed Dial, [4-57](#)

Language

- selection, [lviii](#)

Language selection, [2-10](#)

Leave Message, [lvi](#)

Line coding

- Primary Rate Interface (PRI), [3-32](#)
- T1 service, [3-26](#)

Line compensation

- settings, [3-26](#), [3-32](#)
- T1, [3-26](#)

Line options planning

- BRI Line Options, [3-46](#)
 - Service Profile Identifier (SPID), [3-47](#)
- clock synchronization, [3-49](#)
- timers, [3-50](#)

Lines/trunks

- adding to the system, [6-3](#)
- assigning, [3-52](#)
- capacity, [2-2](#)
- connecting components with, [2-4](#)
- Direct Inward Dial (DID), [3-44](#)
- DS1 connectivity, [3-23](#)
- hold disconnect interval, [3-14](#)
- identifying jacks, [3-1](#)
- incoming types, [3-7](#)
- jacks, [3-2](#)
- labels, [3-8](#)
- loop-start disconnect, [3-12](#)
- modules and jack types, [3-2](#)
- NI-1 BRI connectivity, [3-46](#)
- options, [3-11](#)
- outmode signaling, [3-13](#)
- pools, [3-16](#)

Lines/trunks, (continued)

Primary Rate Interface (PRI), [3-23](#), [3-24](#)

QCC operator to receive calls, [3-15](#)

QCC queue priority, [3-15](#)

remote access, [3-17](#)

T1 service, [3-23](#), [3-25](#)

T1 Switched 56 service, [3-29](#)

tie, [3-40](#)

toll type, [3-14](#)

Voice Messaging System, [3-10](#)

Local Area Networks (LANs)

host computer data stations, [5-13](#), [5-23](#)

workstation data stations, [5-13](#), [5-23](#)

Logical IDs, [2-4](#)

Loop-Start

disconnect signal, [3-12](#)

lines/trunks, [5-25](#)

reliable disconnect, [3-12](#), [3-13](#)

trunk-to-trunk transfer, [3-13](#)

Loudspeaker Paging, [lii](#)

Loudspeaker paging jacks, [3-9](#)

LS-ID Delay, [3-5](#)

M

Magic On Hold, [lv](#), [3-10](#)

Maintenance

enhancements, [lviii](#)

Maintenance Alarm jacks, [3-9](#)

Marked System Speed Dial, [4-57](#)

Marked system speed dial

and star codes, [2-12](#), [4-58](#)

Master extensions, [4-12](#)

MCI 800 services, [D-1](#)

MCI 900 services, [D-1](#)

MCI Prism services, [D-1](#)

MCI Toll services, [3-36](#)

MCI VNet services, [D-1](#)

Megacom 800 services, [3-4](#), [3-25](#), [D-1](#)

Megacom WATS services, [3-4](#), [D-1](#)

MERLIN Identifier, [lv](#)

MERLIN LEGEND Mail, [2-33](#), [4-31](#)

calling groups, [4-31](#)

MERLIN Mail voice messaging system, [2-33](#)

Message center, [4-19](#)

Message-waiting receiver, [4-33](#)

Messaging 2000, [2-32](#), [2-33](#)

Microphone operation, [4-6](#)

MLS telephone

button assignments

Behind Switch mode, [3-68](#)

Hybrid/PBX mode, [3-57](#)

Key mode, [3-65](#)

MLX telephones

- and Delay Announcement Devices, [2-26](#)
 - as programming equipment (MLX-20L telephone), [2-8](#)
 - button assignments in Hybrid/PBX mode, [3-61](#)
 - button assignments in Key and Behind Switch mode, [3-61](#)
 - Extension Copy feature, [4-9](#)
 - jacks, [2-26](#)
 - language, [2-10](#)
 - MFM adjuncts, [4-3](#)
 - microphone operation, [4-6](#)
 - modules, [2-15](#)
 - optional features, [4-2](#)
- MLX-10DP telephone, [liv](#)

Modem, [5-3](#)

- processor, [xlviii](#)

Modem Data Stations, [5-2](#)

Modem data-only stations, [5-8](#)

Modem/ISDN Terminal Adapter Pool, [5-3](#)

Modes of operation, [2-9](#)

Modifications to system

- overview, [6-1](#)
- preparation, [6-1](#)

Modules

- line/trunk jack types and, [3-2](#)
- placement in control unit, [2-1](#)
- touch-tone receivers (TTRs), [2-18](#)
- types, [2-1](#)

Multi-Function Module (MFM)

- assigning buttons, [3-60](#)
- Behind Switch mode and, [2-27](#)
- extension number, [2-27](#)
- MLX telephone, [2-29](#)

MultiQuest, [3-4](#), [D-1](#)

Music-On-Hold, [3-10](#)

N

Network selection table, [3-38](#)

NI-1 BRI, [5-27](#)

- connectivity, [3-46](#)

Night Service, [lvi](#)

- Emergency Allowed List, [4-54](#)
- Exclusion List, [4-54](#)
- group assignment, [4-53](#)
- outward restriction, [4-54](#)
- time set, [4-55](#)

Night Service Coverage Control, [4-56](#)

Novell NetWare, [2-27](#)

Numbering line/trunk jacks, [3-2](#)

Numbering plans, [2-36](#)

Numbering the system, [2-13](#)

O

- Off-Premises Range Extender (OPRE), [lv](#)
 - One-Touch Call Handling, [4-42](#)
 - Operation
 - modes, [2-9](#)
 - Operator features, [4-16](#)
 - Operator hold timer, [4-16](#), [4-21](#)
 - Operator positions, [2-24](#)
 - Outmode signaling, [3-13](#)
 - OUTWATS, [D-1](#)
 - Overflow
 - Prompt-based, [4-39](#)
 - threshold, [4-35](#)
 - time threshold, [4-38](#)
 - Overflow coverage, [4-35](#)
-

P

- Page buttons, [4-23](#)
- PagePac Plus, [lv](#)
- Park return time, [4-43](#)
- Park zones, [4-23](#)
- PassageWay Solution, [lv](#)
- PassageWay Telephony Services for NetWare, [2-30](#)
- PC with System Programming and Maintenance (SPM), [2-8](#)
- PCMCIA card, [2-11](#)
- PCMCIA Memory Card, [xlviii](#), [7-2](#)
- Permanent Key mode, [2-9](#)
- Personal Directory, [liii](#)
- Personal Line, [5-29](#)
- Personal Lines, [5-34](#)
- Personal lines, [4-6](#)
- Personal Speed Dial, [5-34](#)
- Personal Video Conferencing, [5-14](#)
- Pickup groups, [4-25](#)
- Planning forms, [B-1](#)
- Pool, [5-30](#)
- Pool dial-out code, [3-17](#), [4-4](#)
- Pools, [3-16](#)
 - Automatic Route Selection (ARS), [4-59](#), [4-69](#)
- Posted Messages, [4-57](#)
- Power Failure Transfer (PFT) telephones
 - jacks, [2-7](#)
 - module placement, [2-6](#)
- Power supply
 - ferrite cores, [liii](#)
- Primary Cover Ring Delay, [4-13](#)
- Primary operator position, [2-23](#), [2-24](#)
- Primary Rate Interface (PRI), [lvii](#), [3-4](#)
 - B-channel groups, [3-34](#)
 - Call-by-Call Service Selection, [3-38](#)
 - clock synchronization, [3-33](#)
 - DEFINITY and, [lv](#)
 - Dial Plan Routing, [3-34](#)

Primary Rate Interface (PRI), (continued)

- framing format, [3-32](#)
- incoming services, [3-34](#)
- line appearance routing, [3-34](#)
- line coding, [3-32](#)
- line compensation, [3-32](#)
- network selection table, [3-34](#), [3-37](#)
- number to send, [3-39](#)
- options, [3-34](#)
- outgoing services, [3-34](#)
- outgoing tables, [3-36](#)
- overview, [3-30](#)
- review by Lucent, [3-40](#)
- signaling mode, [3-32](#)
- Special Services Selection Table, [3-38](#)
- Terminal Equipment Identifier (TEI), [3-40](#)
- test telephone number, [3-39](#)
- timers and counters, [3-40](#)
- type of service, [3-31](#)

Principal user, [4-6](#)

Priority Call Queuing, [4-38](#)

Privacy, [5-34](#)

Programming

- centralized, [4-2](#)
- enhancements, [lix](#)
- equipment, [2-8](#)
- Extension Copy feature, [4-9](#)
- system, [4-2](#)

Prompt-Based Overflow setting, [2-20](#)

Q

Queue over threshold, [4-18](#)

Queued Call Console (QCC)

- additional operator positions, [2-24](#)
 - adjuncts, [4-3](#)
 - call types, [4-22](#)
 - Direct Station Selector (DSS), [4-17](#)
 - features, [4-3](#), [4-17](#)
 - identification information, [4-3](#)
 - Message Center, [4-19](#)
 - MFM adjunct features, [4-3](#)
 - operator to receive calls, [3-15](#)
 - optional features, [4-3](#)
 - Position-Busy Backup, [4-21](#)
 - primary operator position, [2-23](#)
 - queue priority, [3-15](#), [4-18](#), [4-29](#)
 - Voice Announce, [4-22](#)
-

R

Release 1.0, [3-24](#)

Release 1.1, [3-24](#)

Release 2.0, [3-24](#)

Release 4.1, [3-24](#)

- Release 4.2, [3-24](#)
 - Remote Access, [xliv](#)
 - barrier codes, [3-18](#)
 - dial-in tie trunks, [3-18](#)
 - Direct Inward Dial (DID) trunks, [3-18](#), [3-44](#)
 - modifying, [6-2](#)
 - overview, [3-17](#)
 - Private network tandem trunks, [3-18](#)
 - shared access, [3-18](#)
 - Remote access
 - Direct Inward Dial (DID) trunks, [3-19](#)
 - Remote Call Forward, [4-6](#)
 - forward delay option, [4-6](#)
 - Renumbering
 - 2-digit numbering plan, [2-37](#)
 - 3-digit numbering plan, [2-37](#)
 - AUDIX Voice Power, [2-36](#)
 - overview, [2-36](#)
 - Set Up Space numbering plan, [2-38](#)
 - Requirements
 - CTI Applications, [1-6](#)
 - Return ring, [4-20](#)
 - Ringing frequency
 - 016 module, [2-32](#), [2-35](#)
 - Rotary Dial Enable, [2-32](#), [2-35](#)
-

S

- Sales and Design Support Center (SDSC), [3-40](#)
- Secondary Cover Ring Delay, [4-13](#)
- Secondary Dial Tone Timer, [2-12](#)
- Service Observing, [4-14](#)
- Service Profile Identifier (SPID)
 - planning considerations, [3-47](#)
 - planning form instructions, [3-48](#)
- Set Up Space numbering plan, [2-38](#)
- Shared Access for Switched Services (SASS), [3-4](#)
- Shared System Access (SSA), [1](#)
- Signaling
 - Direct Inward Dial (DID) trunks, [3-45](#)
 - Primary Rate Interface (PRI), [3-32](#)
 - tie trunks, [3-41](#)
- Signaling mode
 - T1 service, [3-26](#)
- Simultaneous voice and data, [2-25](#)
- Software Defined Network (SDN), [3-4](#)
- Speakerphone, [2-29](#)
- Special Services Table, [3-38](#)
- Specifications, environmental
 - CTI, [1-9](#)
- Speed Dial
 - marked system, [4-57](#)
 - marked system and star codes, [2-12](#), [4-58](#)
 - system, [4-57](#)
- Speed dial
 - marked system and star codes, [2-12](#)
- SPM, [7-2](#)

Station Message Detail Recording (SMDR)

language, [2-10](#), [2-11](#)

options, [4-44](#)

Subpatterns, [4-67](#)

Supplemental Alert Adapter (SAA), [2-28](#)

Support calling group, [4-35](#)

Switchhook, [liv](#)

Switchhook flash, [3-4](#)

System

adding to, [6-2](#)

adjuncts, [3-9](#), [3-10](#)

consoles, [2-8](#), [2-12](#)

date, [2-11](#)

extension capacity, [2-2](#)

lines/trunks capacity, [2-2](#)

modifications, [6-1](#)

operating conditions, [2-7](#), [2-25](#), [2-26](#)

programming, [4-2](#)

time, [2-11](#)

System Access buttons

when connected to tip/ring port, [3-55](#)

System Access Ring, [5-29](#)

System features

Automatic Callback interval, [4-43](#)

Camp-On return time, [4-42](#)

one-touch call handling, [4-42](#)

overview, [4-40](#)

Park return time, [4-43](#)

transfer audible, [4-42](#)

transfer options, [4-41](#), [4-42](#)

System numbering

adjuncts, [2-28](#)

extension jacks, [2-14](#)

line/trunk jacks, [3-2](#)

overview, [2-13](#)

plans, [2-36](#)

renumbering, [2-36](#)

System planning form, [B-1](#)

System Programming and Maintenance (SPM)

console, [2-8](#)

software, [2-8](#)

System Programming and Maintenance (SPM) software, [lix](#)

international release, [liv](#)

System Speed Dial, [4-57](#), [5-34](#)

labels, [4-57](#)

T

T1 service

channel service unit (CSU), [3-28](#)

clock synchronization, [3-27](#)

common services, [3-4](#)

digital data transmission, [3-25](#)

framing format, [3-26](#)

line coding, [3-26](#)

line compensation, [3-26](#)

- T1 service, (continued)
 - overview, [3-25](#)
 - signaling mode, [3-26](#)
 - type of service, [3-25](#)
- T1 Switched 56 service, [3-3](#), [3-25](#)
 - clock synchronization, [3-27](#)
 - dial plan routing, [3-30](#)
 - direction, [3-29](#)
 - framing format, [3-26](#)
 - incoming signaling mode, [3-30](#)
 - incoming signaling type, [3-30](#)
 - line appearance routing, [3-30](#)
 - line coding, [3-26](#)
 - line compensation, [3-26](#)
 - outgoing signaling mode, [3-30](#)
 - outgoing signaling type, [3-30](#)
 - overview, [3-29](#)
 - signaling mode, [3-26](#)
 - type of service, [3-25](#)
- TAPI, [GL-26](#)
- Telephone buttons
 - assigning, [3-53](#)
 - Direct-Line Console (DLC), [3-72](#)
 - Hybrid/PBX mode, [3-54](#)
 - Key and Behind Switch mode, [3-61](#)
- Telephones
 - single-line, [lv](#)
- Terminal adapters, [2-26](#)
- Terminal Equipment Identifier (TEI), [3-40](#)
- Test telephone number, [3-34](#), [3-39](#)
- Tie trunks, [3-40](#), [5-26](#)
 - barrier codes, [3-19](#)
 - dial tone, [3-43](#)
 - options, [3-40](#)
 - overview, [3-40](#)
 - remote access and, [3-21](#)
 - signaling, [3-41](#)
- Time, [2-11](#)
- Timers
 - planning considerations, [3-50](#)
 - planning form instructions, [3-51](#)
 - secondary dial tone, [2-12](#)
- Timers and counters, [3-40](#)
- Tip/ring (T/R) equipment, [6-2](#)
 - assigning trunks, [3-52](#)
 - Delay Announcement Devices, [2-32](#)
 - features, [4-3](#)
 - jacks, [2-32](#)
 - MLX telephones, [2-28](#)
 - optional features, [4-3](#)
- tip/ring operation
 - jacks for equipment and applications, [2-32](#)
 - ports programmed on a 412 LS-ID-ETR or 016 ETR module, [2-32](#)
- Toll abuse, [3-44](#)
- Toll type, [3-14](#)
- Touch-tone receivers (TTRs)
 - calculating number required, [2-21](#)
 - modules with, [2-18](#)
 - required by prompt-based overflow, [2-20](#)
 - required by voice mail/auto attendant, [2-19](#)

Touch-tone receivers (TTRs), (continued)
 system requirements, [2-18](#)
 voice messaging system requirement, [2-18](#)
Transfer audible, [4-42](#)
TransTalk Wireless telephone, [2-16](#)
Trunk-to-trunk transfer, [3-12](#), [3-13](#), [4-8](#)
TSAPI, [GL-27](#)

U

Unit load rules, [F-1](#)
Unit load worksheet, [F-3](#)
Unit loads
 Key or Behind Switch Mode, [F-2](#)
Upgrade procedure, [7-3](#)

V

Video endpoints, [2-3](#)
Video System, [5-3](#)
Virtual Private Network, [D-1](#)
Voice Announce to Busy, [2-25](#), [6-2](#)
Voice Mail, Centralized, [2-35](#)
Voice mail/auto attendant
 fails to transfer calls, [2-18](#)
Voice Messaging System
 functions, [3-10](#)
 services, [3-10](#)
Voice messaging systems, [2-18](#)

W

WinSPM, [7-2](#)



We'd like your opinion ...

Lucent Technologies welcomes your feedback on this document.
Your comments can be of great value in helping us improve our documentation.

MERLIN LEGEND® Communications System Release 7.0
System Planning Guide
Issue 1, April 1999
555-670-112, Comcode 108370289

1. Please rate the effectiveness of this document in the following areas:

	Excellent	Good	Fair	Poor
Ease of Finding Information	<input type="checkbox"/>	<input type="checkbox"/>	<input type="checkbox"/>	<input type="checkbox"/>
Clarity	<input type="checkbox"/>	<input type="checkbox"/>	<input type="checkbox"/>	<input type="checkbox"/>
Completeness	<input type="checkbox"/>	<input type="checkbox"/>	<input type="checkbox"/>	<input type="checkbox"/>
Accuracy	<input type="checkbox"/>	<input type="checkbox"/>	<input type="checkbox"/>	<input type="checkbox"/>
Organization	<input type="checkbox"/>	<input type="checkbox"/>	<input type="checkbox"/>	<input type="checkbox"/>
Appearance	<input type="checkbox"/>	<input type="checkbox"/>	<input type="checkbox"/>	<input type="checkbox"/>
Examples	<input type="checkbox"/>	<input type="checkbox"/>	<input type="checkbox"/>	<input type="checkbox"/>
Illustrations	<input type="checkbox"/>	<input type="checkbox"/>	<input type="checkbox"/>	<input type="checkbox"/>
Overall Satisfaction	<input type="checkbox"/>	<input type="checkbox"/>	<input type="checkbox"/>	<input type="checkbox"/>

2. Please check the ways you feel we could improve this document:

- | | |
|--|---|
| <input type="checkbox"/> Improve the overview/introduction | <input type="checkbox"/> Make it more concise |
| <input type="checkbox"/> Improve the table of contents | <input type="checkbox"/> Add more step-by-step procedures/tutorials |
| <input type="checkbox"/> Improve the organization | <input type="checkbox"/> Add more troubleshooting information |
| <input type="checkbox"/> Add more figures | <input type="checkbox"/> Make it less technical |
| <input type="checkbox"/> Add more examples | <input type="checkbox"/> Add more/better quick reference aids |
| <input type="checkbox"/> Add more details | <input type="checkbox"/> Improve the index |

Please add details about your major concerns. _____

3. What did you like most about this document? _____

4. Feel free to write any comments below or on an attached sheet. _____

If we may contact you concerning your comments, please complete the following:

Name: _____ Telephone Number: (____) _____

Company/ Organization: _____ Date: _____

Address: _____