

Plasmavision™

PDS4213W-H / PDS4214W-S  
PDS4213E-H / PDS4214E-S

# SERVICE MANUAL

5

FUJITSU GENERAL Proprietary

CONFIDENTIAL

Copy Prohibited

FUJITSU GENERAL LIMITED

# TROUBLESHOOTING USING LED AND OSD

## 1. Display

### (1) OSD

Two kinds of error messages are displayed on the screen, and the power is turned off 10 sec later.

### (2) LED

LED error is displayed continuously after the power is turned off.

## 2. Error types and check points

### (1) OSD

On screen display	Cause	Check point
ERROR MESSAGE CONDITION 1	Fan protector operated	<ul style="list-style-type: none"> <li>• Fan</li> <li>• AC/DC power unit</li> <li>• DC/DC power PCB</li> <li>• Main/Digital PCB</li> </ul>
ERROR MESSAGE CONDITION 2	Temperature protector operated	<ul style="list-style-type: none"> <li>• Ambient temperature of unit</li> <li>• Main/Digital PCB</li> <li>• Temp. sensor PCB</li> </ul>

### (2) LED

LED lamp display status	Cause	Check point
Steady light (Red)	Stand-by status	—————
<b>Continuous</b> Flashes continuously (Red)	No power Power supply protector operated	<ul style="list-style-type: none"> <li>• AC/DC power unit</li> <li>• DC/DC power PCB</li> <li>• PDP panel</li> </ul>
<b>1 time</b> Flashes once in 3 sec. (Red)	Fan protector operated	<ul style="list-style-type: none"> <li>• Fan</li> <li>• AC/DC power unit</li> <li>• DC/DC power PCB</li> <li>• Main/Digital PCB</li> </ul>
<b>2 times</b> Flashes twice in 3 sec. (Red)	Temperature protector operated	<ul style="list-style-type: none"> <li>• Ambient temperature of unit</li> <li>• Signal PCB</li> <li>• Temperature sensor PCB</li> </ul>
<b>4 times</b> Flashes four times in 3 sec. (Red)	Main/Digital circuit faulty	<ul style="list-style-type: none"> <li>• Main/Digital PCB</li> </ul>
<b>5 times</b> Flashes five times in 3 sec. (Red)	Video circuit faulty	<ul style="list-style-type: none"> <li>• Video PCB Assy</li> </ul>



# TROUBLESHOOTING FLOWCHART

## LED lamp blinking

Turn power on and check state of lamp.

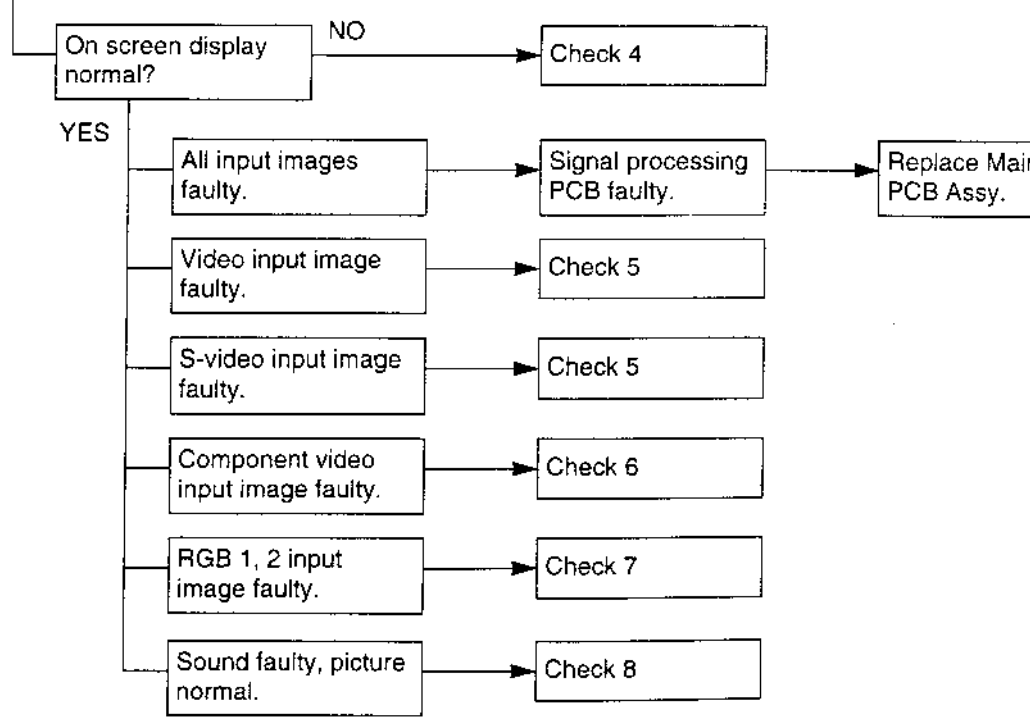
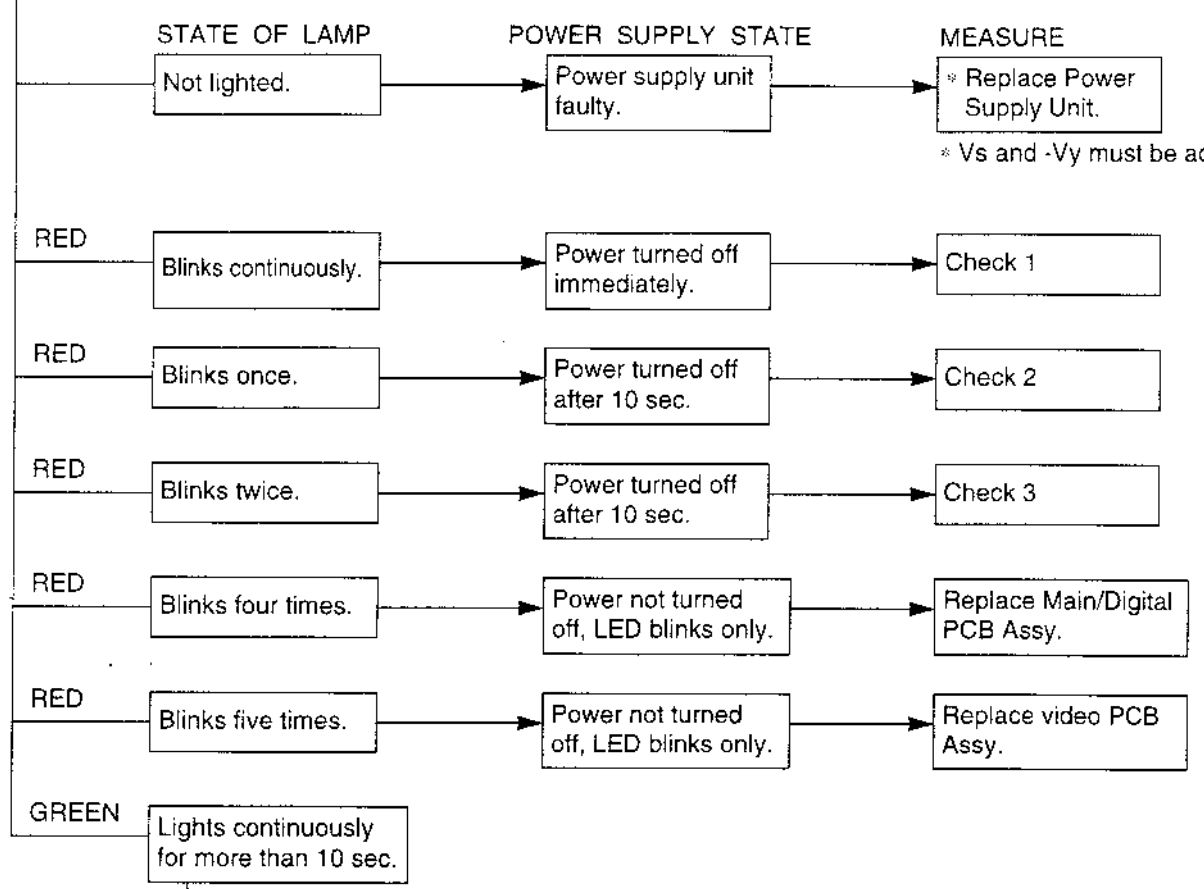



## Check 1

Power supply protector operated

Power lamp : Flashing continuously in red.  
(at an interval of 0.5 sec)

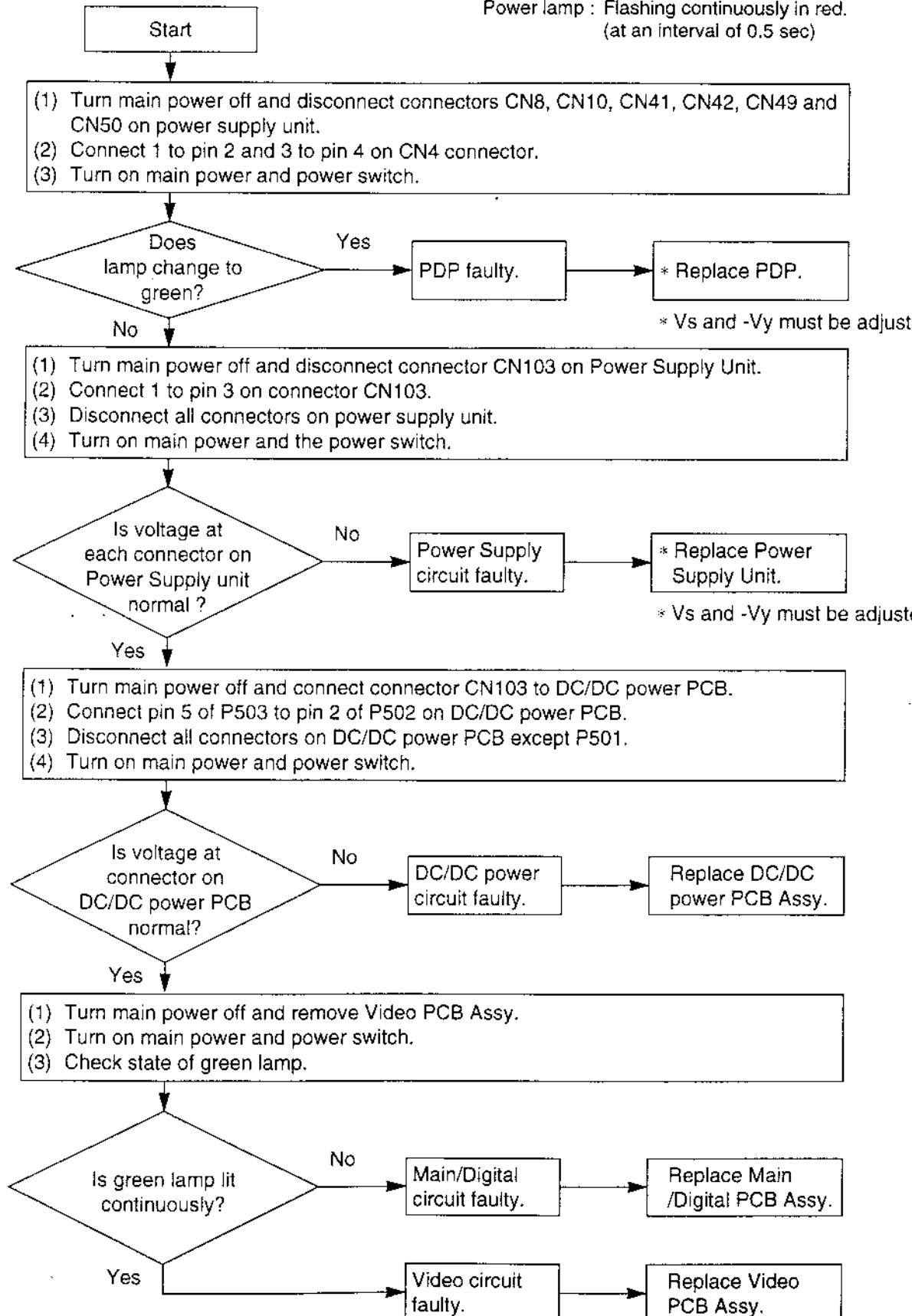



## Check 2

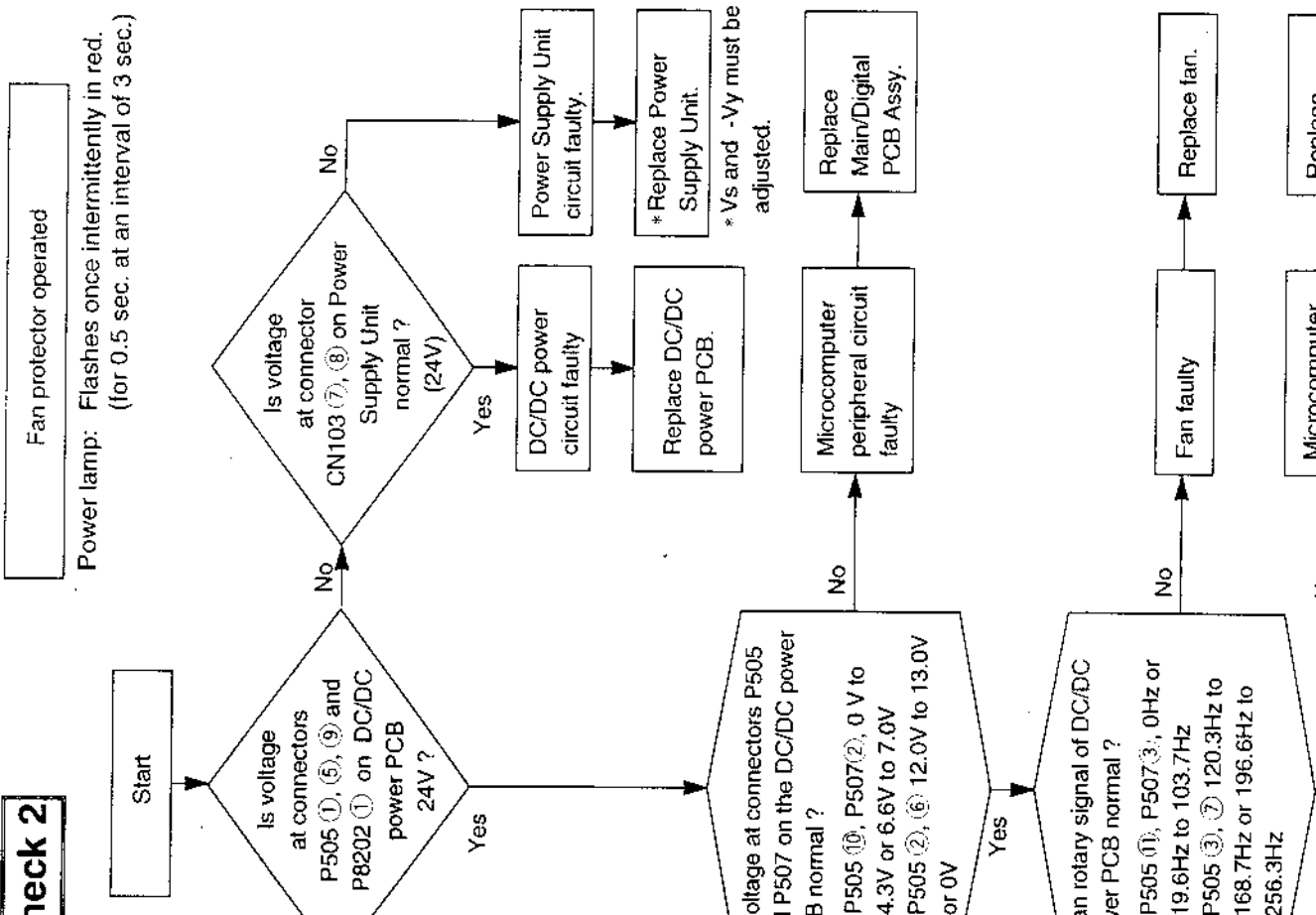

## Check 3

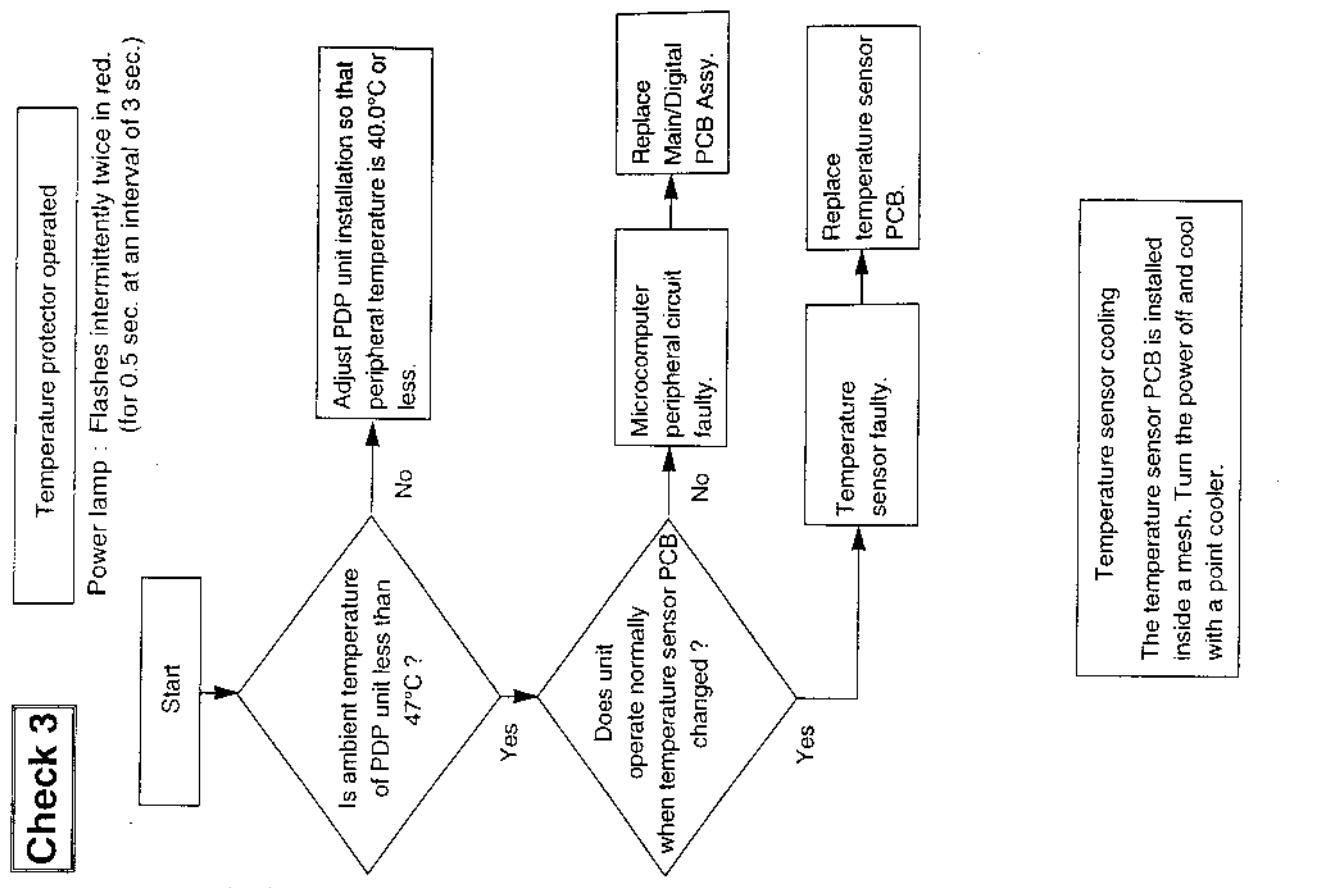



### Check 4

OSD is not displayed.  
Power lamp : Lighted green.  
(10 sec or more)

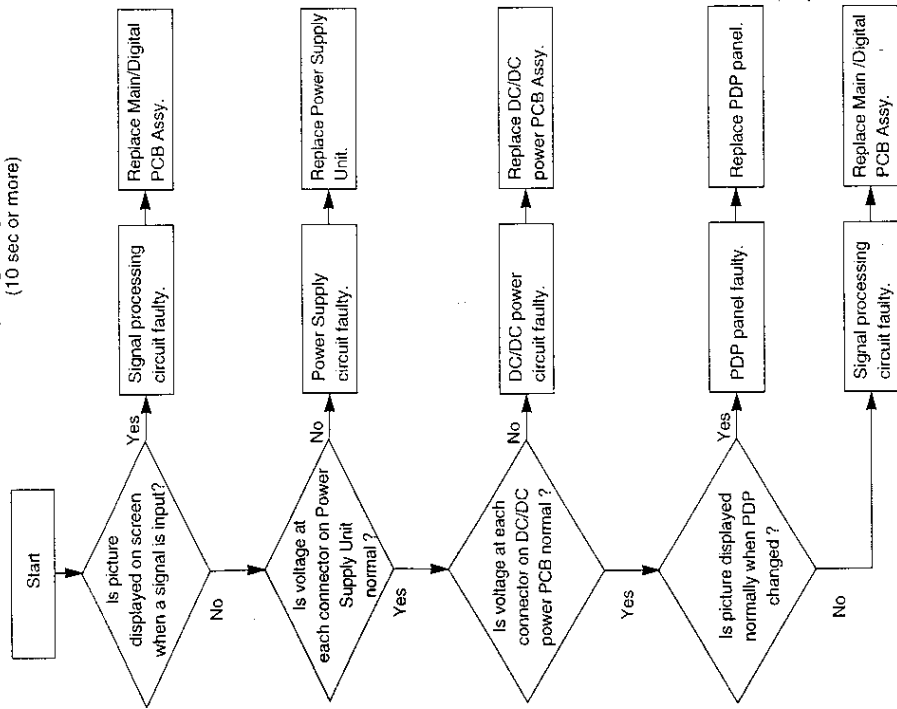

### Check 5

Video/S-video input signals are abnormal.  
Power lamp : Lighted green  
(10 sec or more)

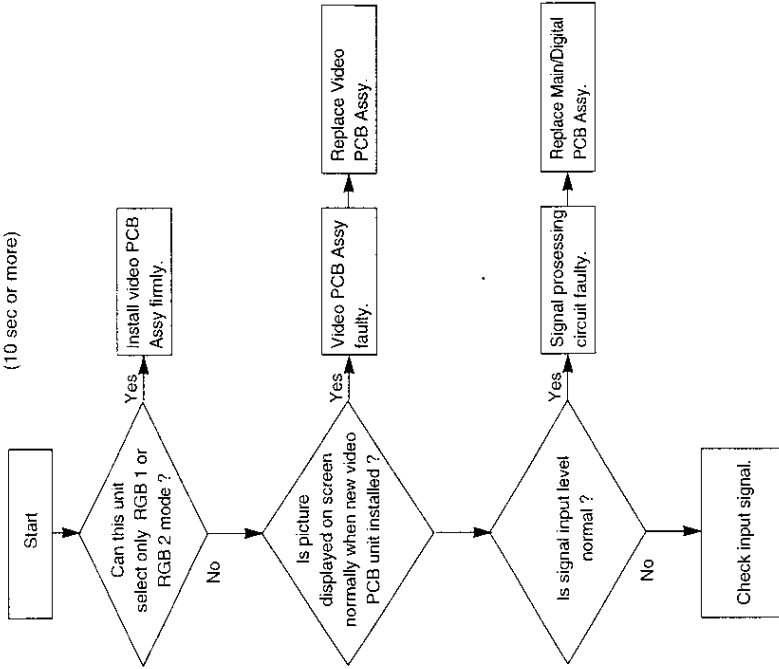

### Check 6

Component input signals (Y/Pb/Pr) are abnormal.

Power lamp : Lighted green  
(10 sec or more)

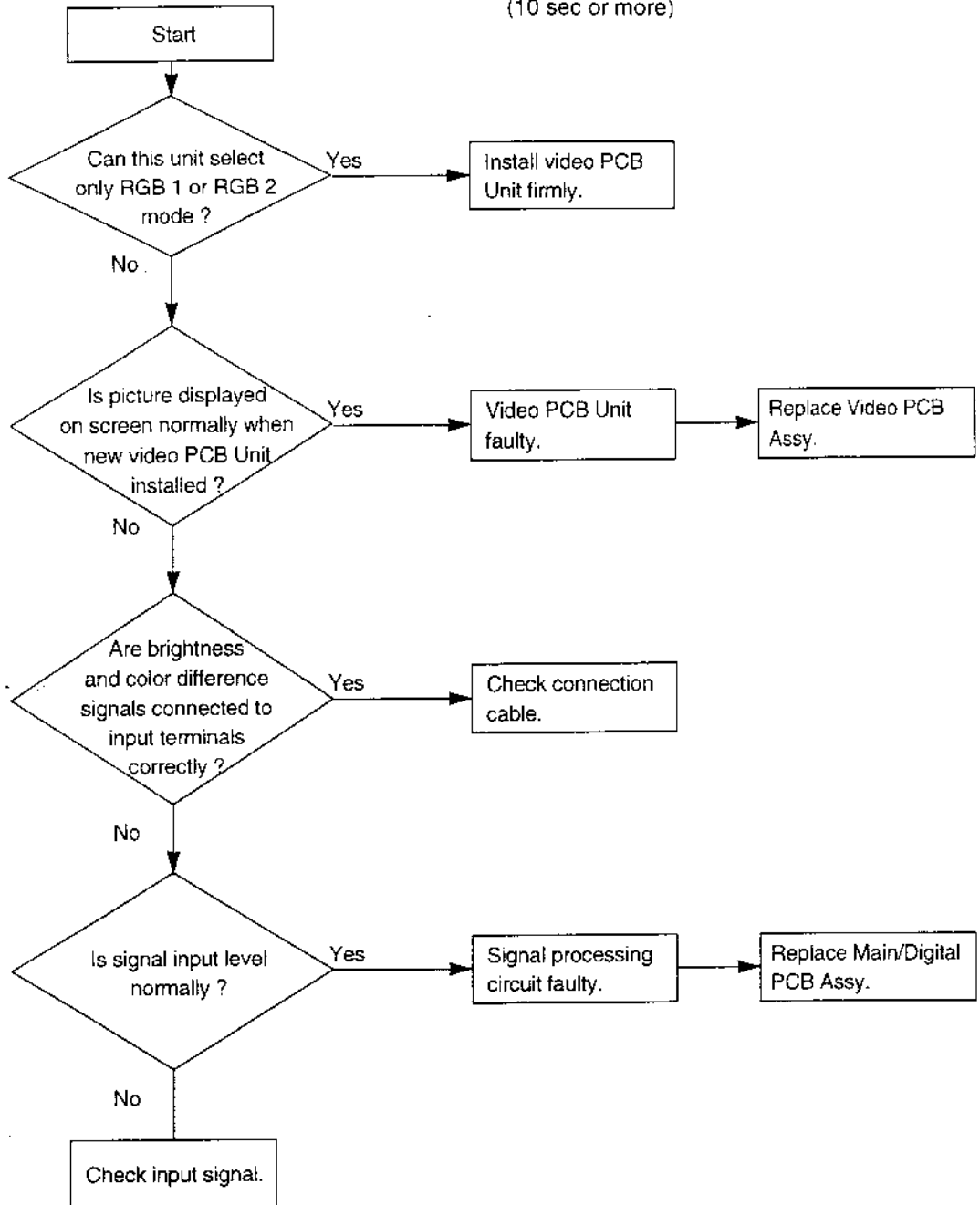

\* SYNC. signals are added to the Y signal.

# Check 7

RGB input is abnormal.  
Power lamp: Lighted green  
(10 sec or more)

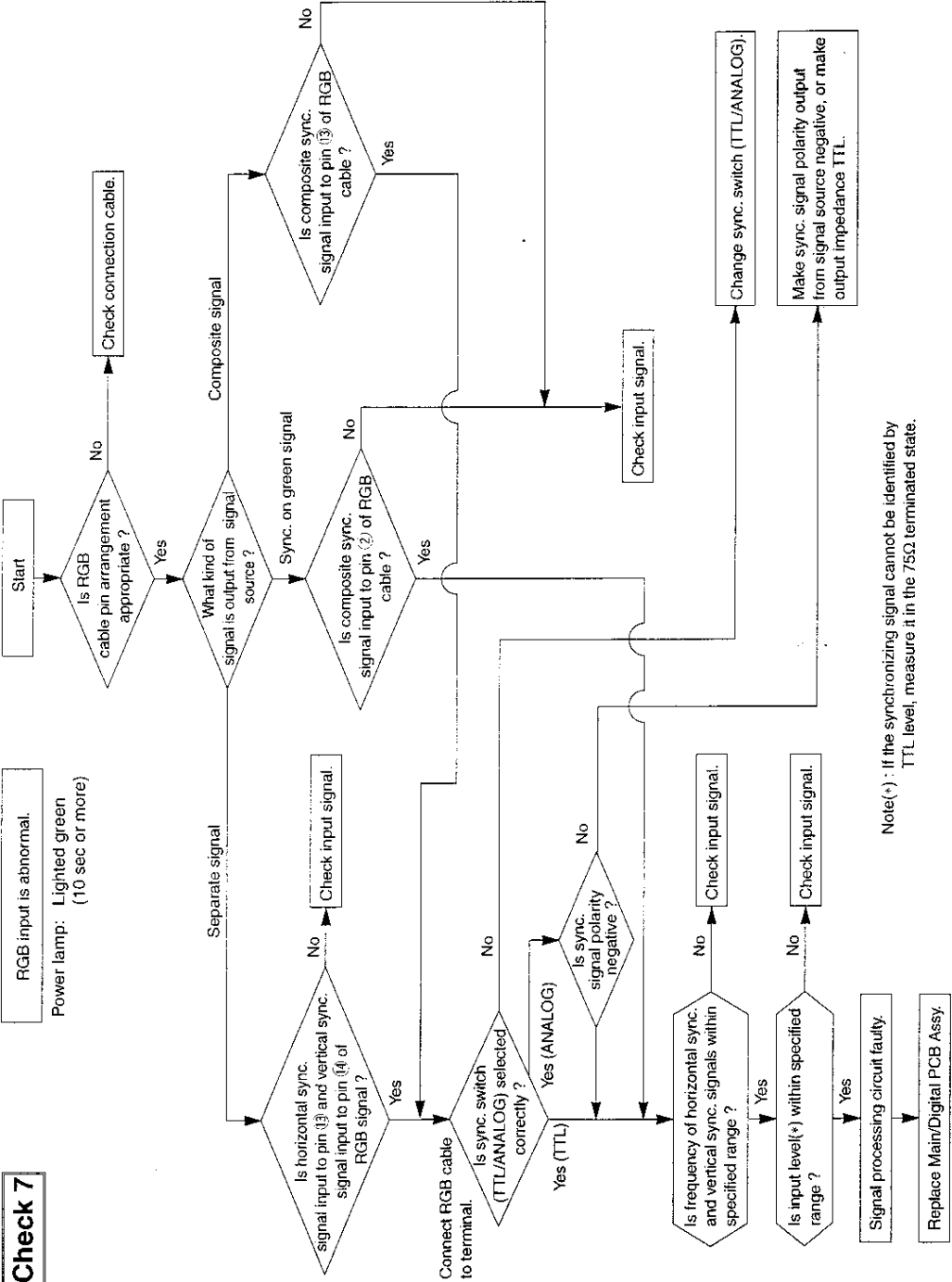

Note(\*) : If the synchronizing signal cannot be identified by TTL level, measure it in the 75Ω terminated state.

**Check 8** Sound is abnormal, picture display normal.

Power lamp: Lighted green  
(10 sec or more)

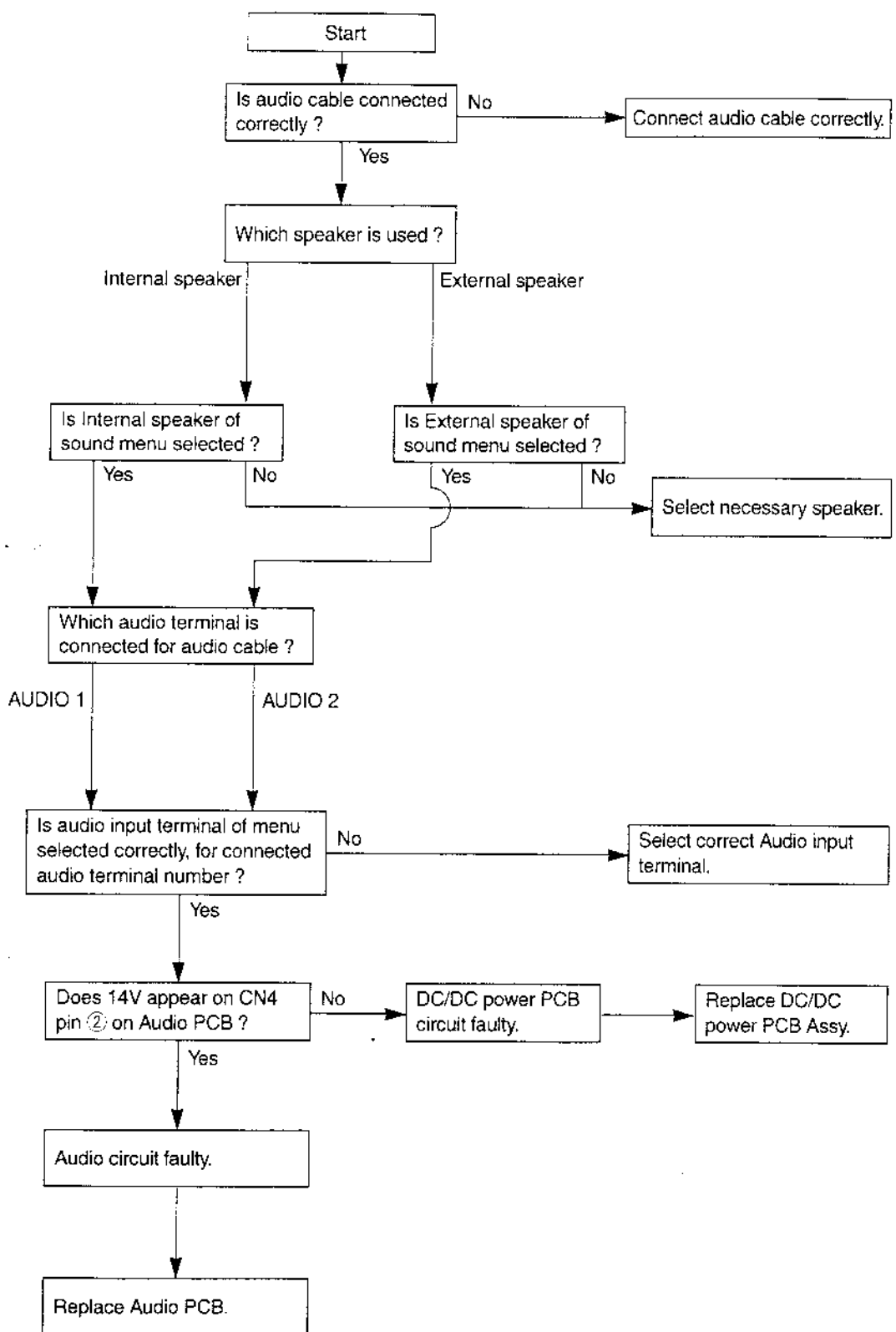



## VOLTAGE OF EACH CONNECTOR

- **Voltage measurement in protect mode**

Because the relay signal is "L" in the protect mode, voltages of Vcc, Vs, and Va are not output. The protect mode is reset only when the power SW is turned off. Therefore, when measuring the voltage, turn off the power SW, then turn on the power by remote control. Remeasure the power supply unit protection operation.

- **Relay signal**

Voltages Vcc, Vs and Va are output only when the relay signal of "CN103-3" is "H". When the microcomputer detects an abnormal voltage, these voltages are not output.

- **ACON signal**

The ACON signal indicates whether or not AC is supplied. The relay signal is output when the ACON signal is "H".

### 1. Power Supply Unit (PFW-422)

CN103 Power supply unit			Ground
No.	NAME	SPEC.	
1	Vpr	5V (4.8 to 5.2V)	②
7	Vcc 2	24V (23.7 to 24.3V)	②

CN49 Power supply unit			Ground
No.	NAME	SPEC.	
1	Vcc 1	5V (4.8 to 5.2V)	②
3	Ve	15.52 to 16.48V	②
10	Vs	165.0 to 185.0V	②

CN42 Power supply unit			Ground
No.	NAME	SPEC.	
3	Vsc	116.4 to 123.6V	④
4	-Vy	-150 to -170V	①
6	Vcc 1	5V (4.8 to 5.2V)	①

CN50 Power supply unit			Ground
No.	NAME	SPEC.	
1	Vw	164.9 to 175.1V	③
2	Va	64.35 to 65.65V	③

### 2. DC/DC Power PCB

P503 DC/DC Power PCB			Ground
No.	NAME	SPEC.	
2	A 5V	5V (4.75 to 5.25V)	①
4	14 V	13.3 to 14.7V	①
5	Vpr	5V (4.8 to 5.2V)	①
8	D 5V	5V (4.75 to 5.25V)	①
9	D 3.3V	3.2 to 3.4V	①
10	A-5V	-5.25 to -4.75V	①



## VS AND -VY ADJUSTMENT

When the Power Supply and PDP units are replaced, Vs and -Vy must be adjusted.

Preparation : Heat-run for 5 minutes with a white pattern in the wide mode.

Adjustment : Adjust Vs and -Vy in the no-signal state (Black picture).

Test and adjustment points : Refer to the drawing below.

Adjustment value : Within  $\pm 0.1V$  of the voltage indicated on the label on the PDP unit.

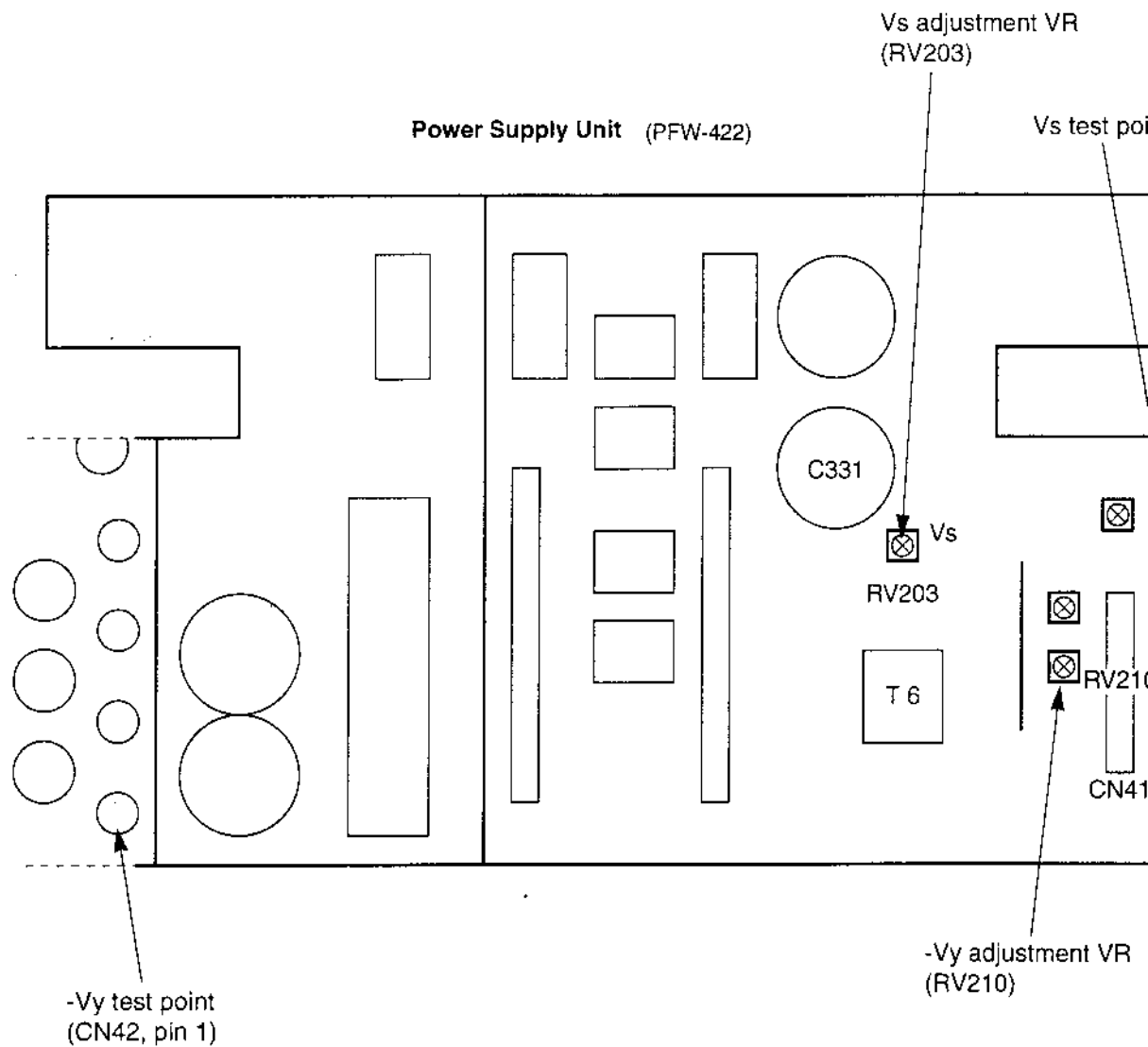





# GENERAL CONNECTION DIAGRAM

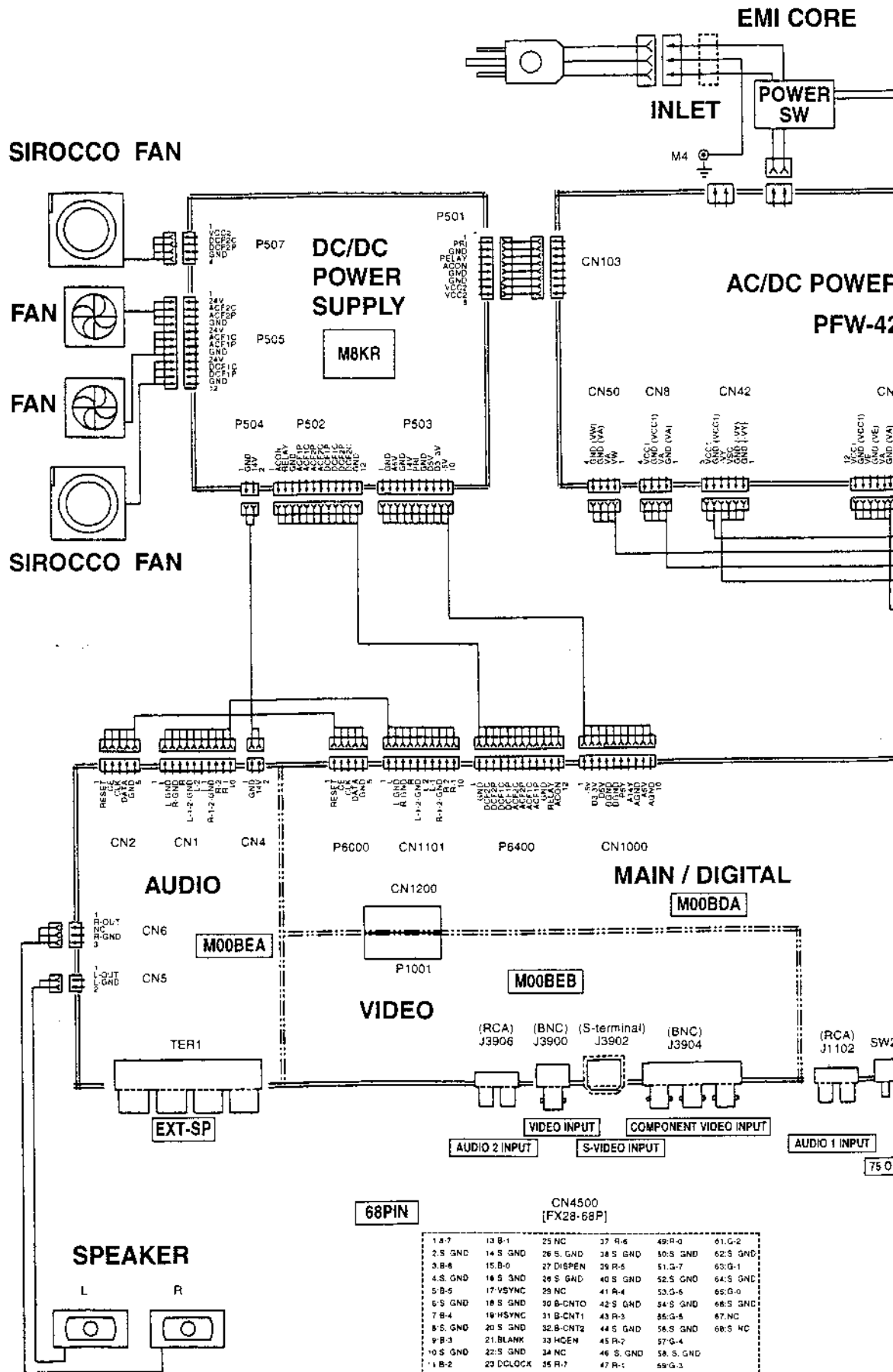

68PIN

CN4500 [FX28-68P]

1:8-7	13 B-1	25 NC	37 R-6	49 R-0	61 G-2
2:5 GND	14 S GND	26 S GND	38 S GND	50 S GND	62 S GND
3:8-6	15 B-0	27 DISPEN	39 R-5	51 G-7	63 G-1
4:5 GND	16 S GND	28 S GND	40 S GND	52 S GND	64 S GND
5:8-5	17 VSYNC	29 NC	41 R-4	53 G-5	65 G-0
6:5 GND	18 S GND	30 B-CNT0	42 S GND	54 S GND	66 S GND
7:8-4	19 HSYNC	31 B-CNT1	43 R-3	55 G-5	67 NC
8:5 GND	20 S GND	32 B-CNT2	44 S GND	56 S GND	68 S NC
9:8-3	21 BLANK	33 HCEN	45 R-2	57 G-4	
10:5 GND	22 S GND	34 NC	46 S GND	58 S GND	
11:8-2	23 DCLOCK	35 R-7	47 R-1	59 G-3	



RE

**OPTICAL FILTER**  
PDS4213 : Glass 2.6 Ω T2.5 985 x 585  
PDS4214 : Mesh T2.5 985 x 585

**POWER SUPPLY**  
**FW-422**

**PLASMA DISPLAY PANEL UNIT**  
**FPF42C10660UE-41**

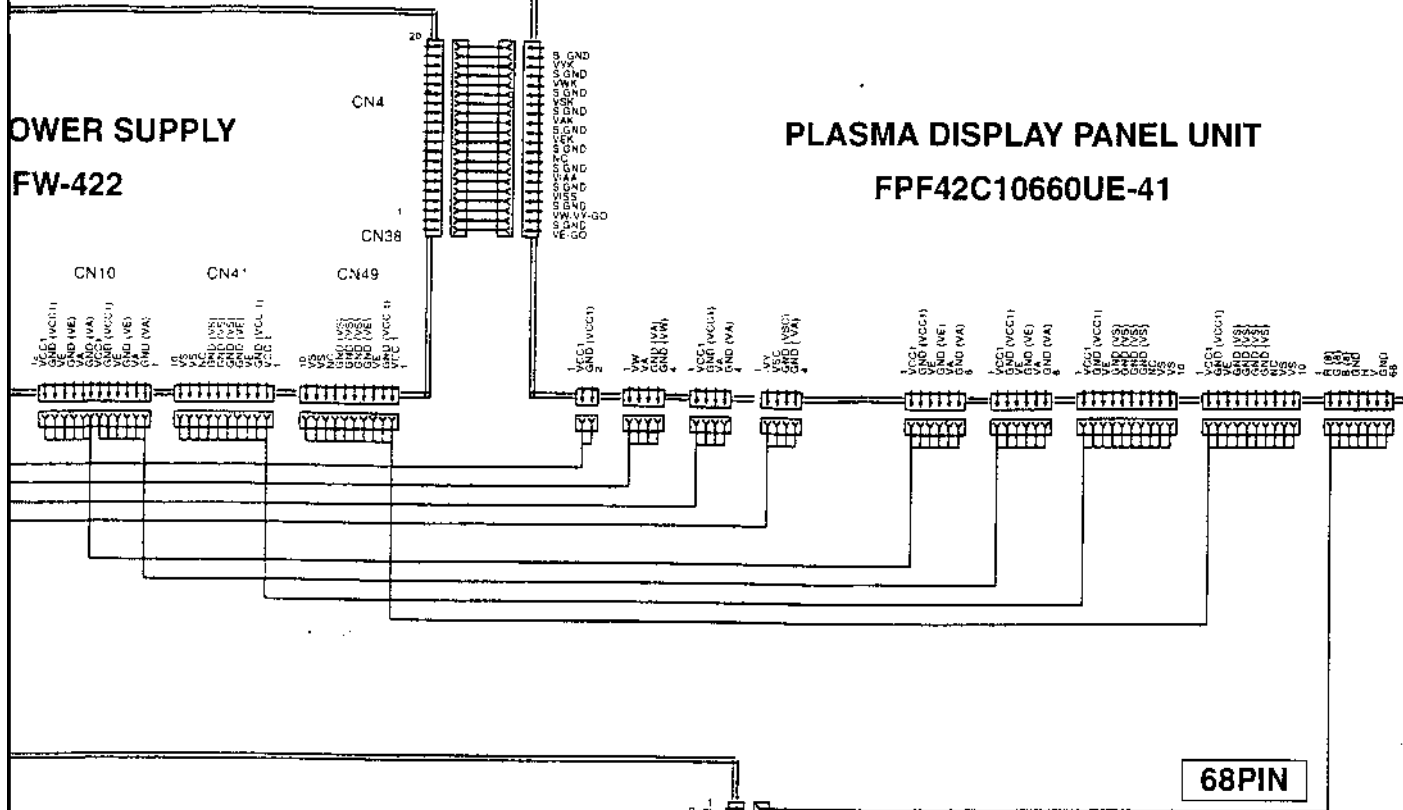

**68PIN**

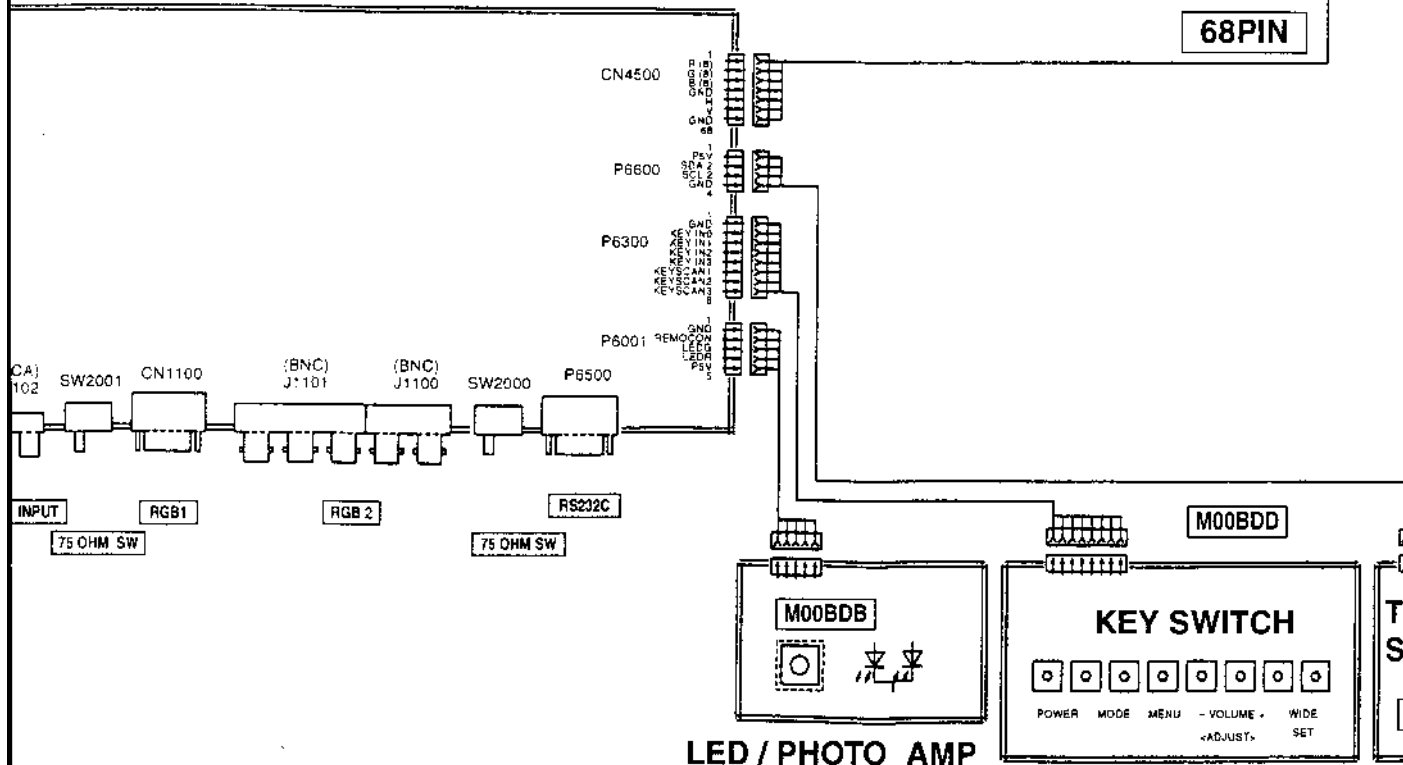

**LED / PHOTO AMP**

